











NTN®

Ball and Roller Bearings

CAT.No.2203/E



Commentary		A- 4
Ball and roller bearings	NTN new generation bearings (ULTAGE series)	B- 5
	Deep groove ball bearings 	B- 17
	Miniature and small size ball bearings 	B- 45
	Angular contact ball bearings 	B- 57
	Self-aligning ball bearings 	B- 79
	Cylindrical roller bearings 	B- 93
	Tapered roller bearings 	B-127
	Spherical roller bearings 	B-211
	Thrust bearings 	B-253
Special application bearings		C- 1
Rolling bearing accessories		D- 1
Needle roller bearings 		E- 1
Bearing units 		F- 1
Plummer blocks 		G- 1
Introduction of catalogs and technical reviews		H- 1
Appendix tables		I- 1

NTN “Ball and Roller Bearings Catalog”

Issue of CAT.No.2203/E

A rolling bearing is an important mechanical element that is used in various machines. Rolling bearings are required to have a long operating life, be small/lightweight, fast, and support special environments. Thus, the performance requirements are becoming more sophisticated and diversified. In particular, technology for enhancing the performance of bearing has been required in recent years. To meet these needs, **NTN** is performing research and development to enhance the performance of the entire machines.

The new general catalog has been entirely revised and edited so that the bearings of an optimum type and size can be provided based on the technical contents that are supported by the result of development and improvement.

The main revisions of the catalog are as follows.

- The latest revision of ISO and JIS is reflected, and the pages of general commentaries such as bearing selection, bearing periphery design, and handling are largely increased.
- Based on the results of in-house durability testing that has been accumulated over a long time, it has been confirmed that the bearing operating life is longer than previously published. Thanks to the continuous improvement of the material, product, and production techniques, the basic dynamic load ratings were revised based on the current bearing operating life data.
- We are developing and expanding “ULTAGE,” a new generation, all-world class rolling bearing series. This catalog introduces the ULTAGE series, which has been developed by **NTN** so far, and includes line-ups that are ready to be manufactured.

We would like you to use the “Ball and Roller Bearings Catalog” which has been revised, and we would like to work and develop with customers “to realize a smooth society”. We hope to receive your continued patronage and support in the future.

Special bearings for each industry and application type are introduced in special sections at the end of the catalog. Please contact **NTN** Engineering for more information.

According to the basic policy of **NTN** corporation, we do not export products or techniques that are regulated by foreign exchange rates or that violate foreign trade laws. For classification of products specified in this catalog, please contact our branch business offices.

In addition, the accuracy of this catalog has been confirmed; however, please note that we do not take any responsibility or liability for any erroneous descriptions or omissions.



Ball and Roller Bearings

TECHNICAL EXPLANATION CONTENTS

<p>1. Classification and characteristics of rolling bearings A-4</p> <p>1.1 Structure A-4</p> <p>1.2 Classification A-4</p> <p>1.3 Characteristics A-8</p> <p>2. Bearing selection A-14</p> <p>2.1 Bearing selection flow chart A-14</p> <p>2.2 Type and characteristics A-16</p> <p>2.3 Selection of bearing arrangement A-17</p> <p>3. Load rating and life A-20</p> <p>3.1 Bearing life A-20</p> <p>3.2 Basic rating life and basic dynamic load rating A-20</p> <p>3.3 Adjusted rating life A-22</p> <p>3.4 Modified rating life A-24</p> <p>3.5 Machine applications and requisite life A-27</p> <p>3.6 Weibull distribution and life adjustment factor for reliability A-28</p> <p>3.7 Misalignment angle (installation error) and life A-29</p> <p>3.8 Clearance and life A-30</p> <p>3.9 Basic static load rating A-30</p> <p>3.10 Allowable static equivalent load A-31</p> <p>3.11 Allowable axial load A-31</p> <p>3.12 Review of basic dynamic load ratings A-33</p> <p>3.13 Bearing life calculation tool A-33</p> <p>4. Bearing load calculation A-34</p> <p>4.1 Load acting on shafts A-34</p> <p>4.2 Bearing load distribution A-39</p> <p>4.3 Mean load A-40</p>	<p>4.4 Equivalent load A-41</p> <p>4.5 Bearing rating life and load calculation examples A-43</p> <p>5. Boundary dimensions and bearing number codes A-46</p> <p>5.1 Boundary dimensions A-46</p> <p>5.2 Bearing numbers A-48</p> <p>6. Bearing tolerances A-54</p> <p>6.1 Dimensional and rotational accuracy A-54</p> <p>6.2 JIS terms A-56</p> <p>6.3 Chamfer measurements and tolerance or allowable values of tapered bore A-70</p> <p>6.4 Bearing tolerance measurement methods A-72</p> <p>6.5 Geometrical product specifications (GPS) A-73</p> <p>7. Bearing fits A-75</p> <p>7.1 Resultant fits A-75</p> <p>7.2 The necessity of a proper fit A-75</p> <p>7.3 Fit selection A-76</p> <p>8. Bearing internal clearance and preload A-88</p> <p>8.1 Bearing internal clearance A-88</p> <p>8.2 Selection of internal clearance A-88</p> <p>8.3 Preload A-100</p> <p>8.4 Necessary minimum load A-104</p> <p>9. Allowable speed A-106</p> <p>9.1 Constant speed rotation A-106</p>	<p>9.2 Low-speed rotation and rapid acceleration/deceleration A-107</p> <p>9.3 Oscillating applications A-107</p> <p>9.4 Heat rating rotational speed A-108</p> <p>10. Friction and temperature rise A-109</p> <p>10.1 Friction A-109</p> <p>10.2 Temperature rise A-109</p> <p>10.3 Starting torque calculation A-110</p> <p>11. Lubrication A-111</p> <p>11.1 Purpose of lubrication A-111</p> <p>11.2 Lubrication methods and characteristics A-112</p> <p>11.3 Grease lubrication A-112</p> <p>11.4 Solid grease A-119</p> <p>11.5 Oil lubrication A-120</p> <p>12. External bearing sealing devices A-124</p> <p>13. Bearing materials A-128</p> <p>13.1 Raceway and rolling element A-128</p> <p>13.2 Cage A-131</p> <p>13.3 Rubber seal materials A-132</p> <p>13.4 Periphery of bearing (shaft, housing) A-132</p> <p>13.5 NTN bearings with prolonged life A-132</p> <p>13.6 Bearing fatigue analysis technique A-139</p> <p>14. Shaft and housing design A-146</p> <p>14.1 Fixing of bearings A-147</p> <p>14.2 Bearing fitting dimensions A-148</p>	<p>14.3 Shaft and housing accuracy A-149</p> <p>14.4 Bearing permitted inclination/allowable alignment angle A-149</p> <p>15. Bearing handling A-150</p> <p>15.1 General information A-150</p> <p>15.2 Bearing storage A-150</p> <p>15.3 Bearing installation A-152</p> <p>15.4 Lubricant enclosure A-161</p> <p>15.5 Post installation running test A-161</p> <p>15.6 Bearing disassembly A-161</p> <p>15.7 Bearing maintenance and inspection A-164</p> <p>15.8 Bearing maintenance tools A-168</p> <p>16. Bearing damage and corrective measures A-170</p> <p>16.1 Bearing damage, main causes of bearing damage, and remedies for correcting the problem A-170</p> <p>16.2 Rolling paths and how load is applied A-176</p> <p>17. Technical data A-178</p> <p>17.1 Radial internal clearances vs. axial internal clearances A-178</p> <p>17.2 Axial load vs. axial displacement A-183</p> <p>17.3 Allowable axial load A-187</p> <p>17.4 Fitting surface pressure A-188</p> <p>17.5 Necessary press fit and pullout force A-190</p> <p>17.6 Bearing technique calculation tool A-190</p>
---	--	---	---

1. Classification and characteristics of rolling bearings

1.1 Structure

Most rolling bearings consist of **rings with a raceway** (inner ring and outer ring), **rolling elements** (either balls or rollers) and a **cage** as shown in Fig. 1.1 (Figs. A to H). The cage separates the rolling elements at regular intervals, holds them in place within the inner and outer raceways, and allows them to rotate freely.

Raceway (inner ring and outer ring) or raceway washer¹⁾ (shaft or housing)

The surface on which rolling elements roll is called the “**raceway surface**.” The load placed on the bearing is supported by this contact surface.

Generally the inner ring fits on the axle or shaft and the outer ring in the housing.

Note 1: The raceway of thrust bearings is called the “**raceway washer**,” the inner ring is called the “**shaft raceway washer**” and the outer ring is called the “**housing raceway washer**.”

Rolling elements

Rolling elements are classified into two types: **balls** and **rollers**. Rollers come in four types: **cylindrical**, **needle**, **tapered**, and **spherical**. **Balls** geometrically contact with the raceway surfaces of the inner and outer rings at “**points**”, while the contact surface of **rollers** is a “**line**” contact. Theoretically, rolling bearings are constructed to allow the rolling elements to rotate orbitally while also rotating on their own axes at the same time.

Cage

Cages function to maintain rolling elements at a uniform pitch so a load is never applied directly to the cage and to prevent the rolling elements from falling out when handling the bearing. Types of cages differ according to the way they are manufactured and include: **pressed**, **machined** and **formed cages**.

1.2 Classification

Rolling bearings are divided into two main classifications: **ball bearings** and **roller bearings**. Ball bearings are classified according to their bearing ring configurations: **deep groove type** and **angular contact type**. Roller bearings on the other hand are classified according to the shape of the rollers: **cylindrical**, **needle**, **tapered** and **spherical**. Rolling bearings can be further classified according to the direction in which the load is applied; **radial bearings** carry radial loads and **thrust bearings** carry axial loads. Other classification methods include: 1) number of rolling rows (**single**, **double**, or **4-row**), 2) **separable** and **non-separable**, in which either the inner ring or the outer ring can be detached.

There are also bearings designed for special applications, such as: precision rolling bearings for machine tools, bearings for special environments, as well as linear motion bearings (linear ball bearings, linear roller bearings and linear flat roller bearings). Types of rolling bearings are given in Fig. 1.2. For more detailed information, please refer to the page that introduces each bearing.

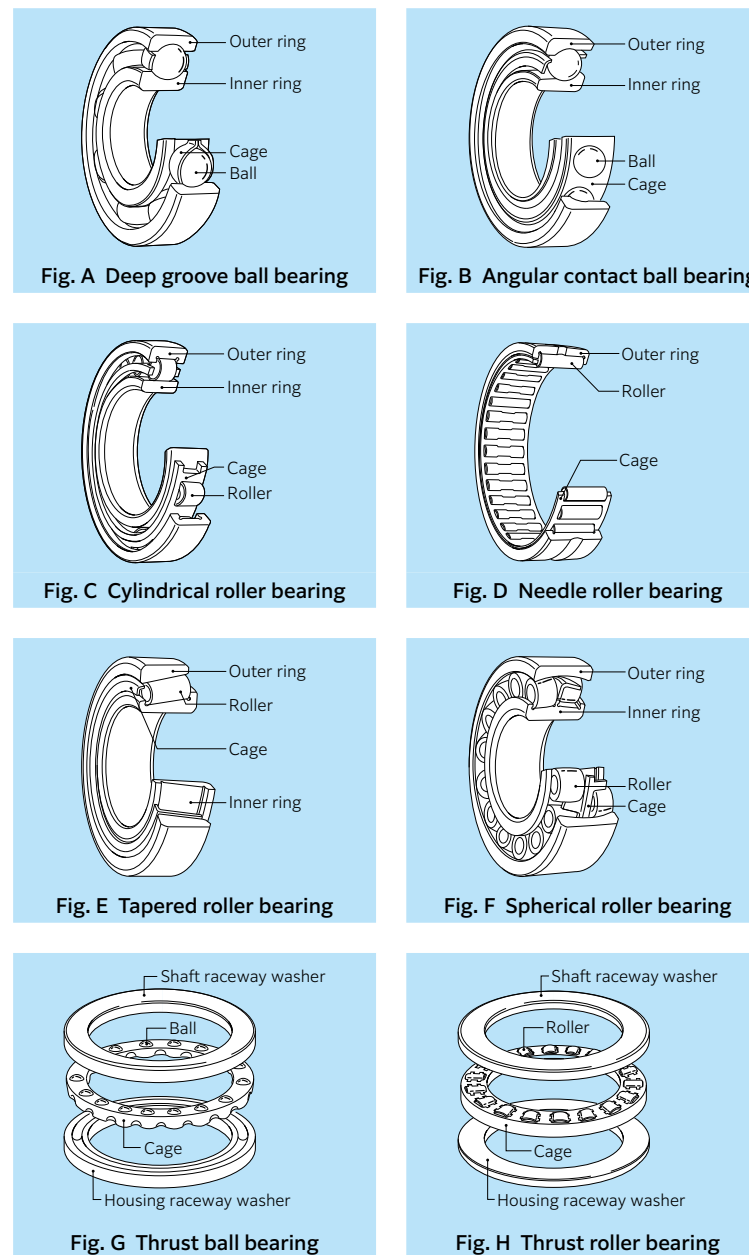

Fig. 1.1 Rolling bearing

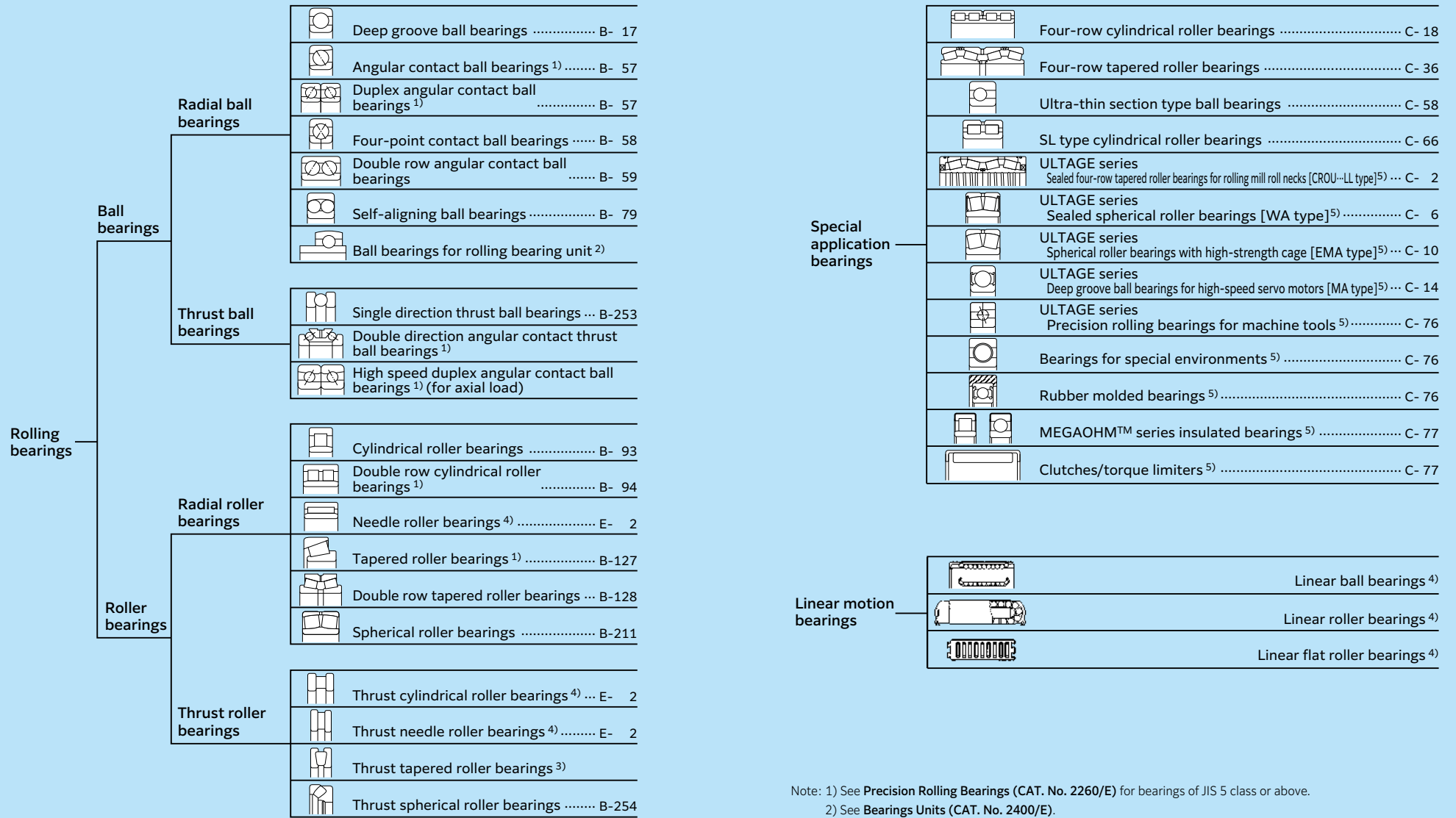

Fig. 1.2 Classification of rolling bearings

Note: 1) See Precision Rolling Bearings (CAT. No. 2260/E) for bearings of JIS 5 class or above.
 2) See Bearings Units (CAT. No. 2400/E).
 3) See Large Bearings (CAT. No. 2250/E).
 4) See Needle Roller Bearings (CAT. No. 2300/E).
 5) See the section of "Introduction of catalogs and technical reviews" for the Cat. No of bearings marked with * 5.

1.3 Characteristics

1.3.1 Characteristics of rolling bearings

Rolling bearings come in many shapes and varieties, each with its own distinctive features. However, when compared with sliding bearings, rolling bearings all have the following advantages:

- (1) The **starting friction coefficient** is lower and there is little difference between this and the **dynamic friction coefficient**.
- (2) They are internationally standardized, **interchangeable** and readily obtainable.
- (3) They are easy to lubricate and consume less **lubricant**.
- (4) As a general rule, **one bearing** can carry both radial and axial loads at the same time.
- (5) May be used in either high or low temperature applications.
- (6) **Bearing rigidity** can be improved by **preloading**.

Construction, classes, and special features of rolling bearings are fully described in the boundary dimensions and bearing numbering system section.

1.3.2 Ball bearings and roller bearings

Table 1.1 gives a comparison of ball bearings and roller bearings.

Table 1.1 Comparison of ball bearings and roller bearings

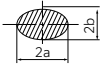
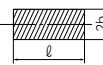
	Ball bearing	Roller bearing
Contact with raceway	 <p>Point contact Contact surface is oval when a load is applied.</p>	 <p>Linear contact Contact surface is generally rectangular when a load is applied.</p>
Characteristics	Because of point contact, where there is little rolling resistance, ball bearings are suitable for low torque and high-speed applications. They also have superior acoustic characteristics.	Because of linear contact, rotational torque is higher for roller bearings than for ball bearings, but rigidity is also higher.
Load capacity	Load capacity is lower for ball bearings, but radial bearings are capable of bearing loads in both the radial and axial direction.	Load capacity is higher for rolling bearings. Cylindrical roller bearings equipped with a lip can bear slight axial loads. Combining tapered roller bearings in pairs enables the bearings to bear an axial load in both directions.

1.3.3 Contact angle and bearing type

A contact angle is an angle made by a line that connects the contact point of the inner ring, rolling element, and outer ring in the radial direction when a load is applied on the bearing (Fig. 1.3).

Bearings with a **contact angle of 45° or less** have a much greater radial load capacity and are classed as **radial bearings**; whereas bearings which have a contact angle over 45° have a greater axial load capacity and are classed as **thrust bearings**. There are also bearings classed as complex bearings which combine the loading characteristics of both radial and thrust bearings.

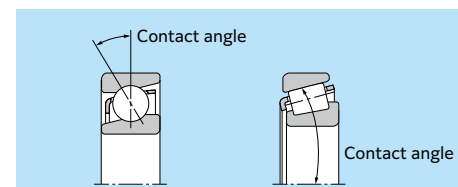

Fig. 1.3 Contact angle

1.3.4 Load acting on bearing

Types of loads applied on rolling bearings are given in Fig. 1.4. A moment load is caused by an unbalanced load and misalignment.

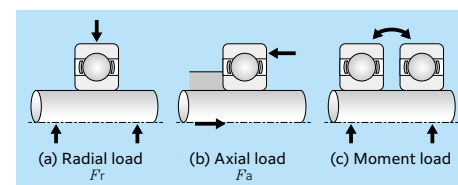

Fig. 1.4 Types of load

1.3.5 Standard bearings and special bearings

The boundary dimensions and shapes of bearings conforming to international standards are interchangeable and can be obtained easily and economically all over the world. It is therefore better to design mechanical equipment that can use standard bearings.

However, depending on the type of machine they are to be used in, and the expected application and function, a non-standard or specially designed bearing may be best. Bearings that are adapted to specific applications, and “unit bearings” which are integrated (built-in) into a machine's components, and other specially designed bearings are also available.





The features of typical standard bearings are as follows:

Deep groove ball bearing

The most common type of bearing, deep groove ball bearings are widely used in a variety of fields. Deep groove ball bearings can include shielded bearings or sealed bearings with grease to make them easier to use.

Deep groove ball bearings also include bearings with a locating snap-ring to facilitate positioning when mounting the outer ring, expansion compensating bearings which absorb dimension variation of the bearing fitting surface due to housing temperature, and TAB bearings that are able to withstand contamination in the lubricating oil.

Table 1.2 Configuration of sealed ball bearings

Type and code	Shielded type	Sealed type		
	Non-contact type ZZ	Non-contact type LLB	Contact type LLU	Low torque type LLH
Structure				

Angular contact ball bearing

The line that unites the point of contact of the inner ring, ball and outer ring runs at a certain angle (contact angle) in the radial direction.

Angular contact ball bearings are generally designed with three contact angles. (Refer to **Table 1.3**)

Angular contact ball bearings can support an axial load, but cannot be used by themselves because of the contact angle. They must instead be used in pairs or in combination. (Refer to **Table 1.5**)

Angular contact ball bearings include double row angular contact ball bearings for which the inner and outer rings are combined as a single unit. (Refer to **Table 1.4**) The contact angle of double row angular contact ball bearings is 25°.

There are also four-point contact bearings that can support an axial load in both directions by themselves. These bearings however require caution because problems such as excessive temperature rise and wear could occur depending on the load conditions.

Table 1.3 Contact angle and symbol

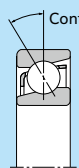

Contact angle and contact angle symbol			
Contact angle	15°	30°	40°
Contact angle symbol	C	A ¹⁾	B

Note: 1. Contact angle symbol has been abbreviated as "A".

Table 1.4 Configuration of double row angular contact ball bearings

Type and code	Open type	Shielded type ZZ	Non-contact sealed type LLM	Contact sealed type LLD
Structure				

Table 1.5 Combinations of duplex angular contact ball bearings

Type and symbol	Back-to-back arrangement DB	Face-to-face duplex DF	Tandem arrangement DT
Structure			

l : Distance between load centers

Cylindrical roller bearing

Cylindrical roller bearings use rollers for rolling elements, and therefore have a high load capacity. The rollers are guided by the ribs of the inner or outer ring. The inner and outer rings can be separated to facilitate assembly, and both can be fit with a shaft or housing tightly. If there are no ribs, either the inner or the outer ring can move freely in the axial direction. Cylindrical roller bearings are therefore ideal to be used as so-called "free side bearings" that absorb shaft expansion. In the case where there are ribs, the bearing can bear a slight axial load between the end of the rollers and the ribs. Cylindrical roller bearings include the HT type which modifies the shape of the roller end face and ribs for increasing axial load capacity, and the EA type and E type with a special internal design for enhancing radial load capacity. The EA type is standardized for small-diameter sizes.

Table 1.6 shows the basic shapes.

In addition to these, there are cylindrical roller bearings with multiple rows of rollers and the SL type of full complement roller bearings without a cage.

Table 1.6 Types of cylindrical roller bearings

Type code	Type NU Type N	Type NJ Type NF	Type NUP Type NH (NJ HJ)
Design			

Tapered roller bearing

Tapered roller bearings are designed so the inner/outer ring raceway and apex of the tapered rollers intersect at one point on the bearing centerline. By receiving a combined load from the inner and outer ring, the rollers are pushed against the inner ring rib and are guided by the rib.

Induced force is produced in the axial direction when a radial load is applied, so it must be handled with a pair of bearings. The inner ring with rollers and outer ring come apart, thus facilitating mounting with clearance or preload. Assembled clearance is however hard to manage and requires special attention. Tapered roller bearings are capable of supporting large loads in both the axial and radial directions.

NTN also has a line of case hardened steel bearings designed for longer life (ETA-, etc.). **NTN** tapered roller bearings also include bearings with two and four rows of tapered rollers for extra-heavy loads.

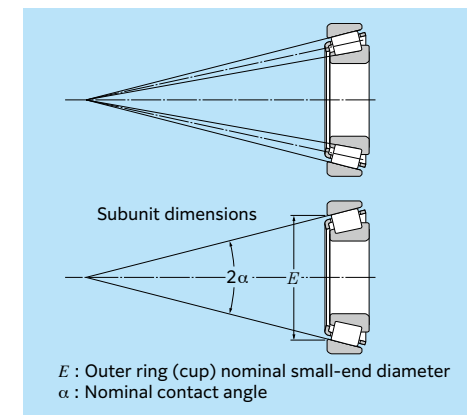

Fig. 1.5 Tapered roller bearings

Spherical roller bearing

Equipped with an outer ring with a spherical raceway surface and an inner ring which holds two rows of barrel-shaped rolling elements, **NTN** spherical roller bearings are able to adjust center alignment to handle inclination of the axle or shaft.

There are a variety of spherical roller bearing types that differ according to their internal design.

In addition to cylindrical bore inner rings, spherical roller bearings can be produced with a tapered bore inner ring. The tapered bore bearing can easily be mounted on a shaft by means of an adapter or withdrawal sleeve. The bearing is capable of supporting heavy loads, and is therefore often used for industrial machinery. When a heavy axial load is applied to the bearing, the load on rollers of one row is not applied, and can cause problems. Attention must therefore be paid to operating conditions.

Table 1.7 Types of spherical roller bearings

Type	ULTAGE		B type	C type	213 type
	EA type	EM type			
Structure					

Thrust bearing

There are many types of thrust bearings that differ according to the shape of the rolling element and application.

Allowable rotational speed is generally low and special attention must be paid to lubrication.

In addition to the types shown in **Table 1.8** below, there are various other types of thrust bearings for special applications.

Table 1.8 Types of thrust bearings

Type	Single direction thrust ball bearing	Needle roller thrust bearings
Structure		 AXK type AS type raceway washer GS/WS type raceway washer
	Thrust cylindrical roller bearing	Thrust self-aligning roller bearing

Needle roller bearing

Needle roller bearings use needle rollers as rolling elements. The needle rollers are a maximum of 6 mm in diameter and are 3 to 10 times as long as they are in diameter (JIS B1506 rolling bearings roller). Because the bearings use needle rollers as rolling elements, the cross-section is thin, but they have a high load capacity for their size. Due to the large number of rolling elements, bearings have high rigidity and are ideally suited to oscillating motion.

There are various types of needle roller bearings, and just a few of the most representative types are covered here. For details, see the catalog "**Needle roller bearings (CAT. No. 2300/E).**"

Table 1.9 Main types of needle roller bearings

Type	Needle roller bearing with cage
Structure	
	Solid type needle roller bearings
	Drawn cup needle roller bearings
	Cam follower Roller follower

Bearing unit

A unit comprised of a ball bearing inserted into various types of housings. The housing can be bolted onto machinery and the inner ring can be easily mounted on the shaft with a set screw.

This means the bearing unit can support rotating equipment without a special design to allow for mounting. A variety of standardized housing shapes are available, including pillow block and flange types. The outer diameter of the bearing is spherical just like the inner diameter of the housing, so it is capable of aligning itself on the shaft.

For lubrication, grease is filled inside the bearing, and foreign particles are prevented from entering with a shaft riding seal and slinger shield.

For details, see the catalog "**Bearing unit (CAT. No. 2400/E).**"

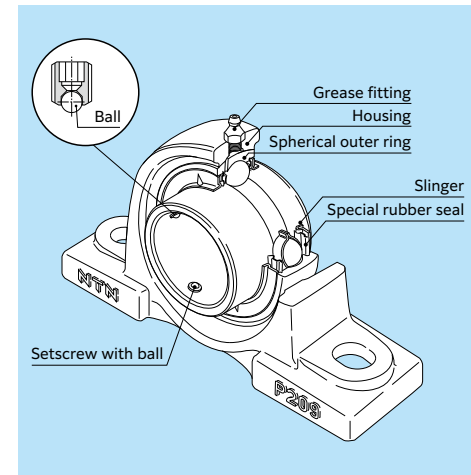

Fig. 1.6 Bearing unit with grease fitting

2. Bearing selection

NTN provides rolling bearings (hereinafter referred to as bearings) of various types and dimensions. When selecting the correct bearing for your application, it is important to consider several factors, and analyze using various means.

2.1 Bearing selection flow chart

An example of the procedure for selecting bearings is shown in the following flow chart. When special consideration is necessary, consult with NTN Engineering.

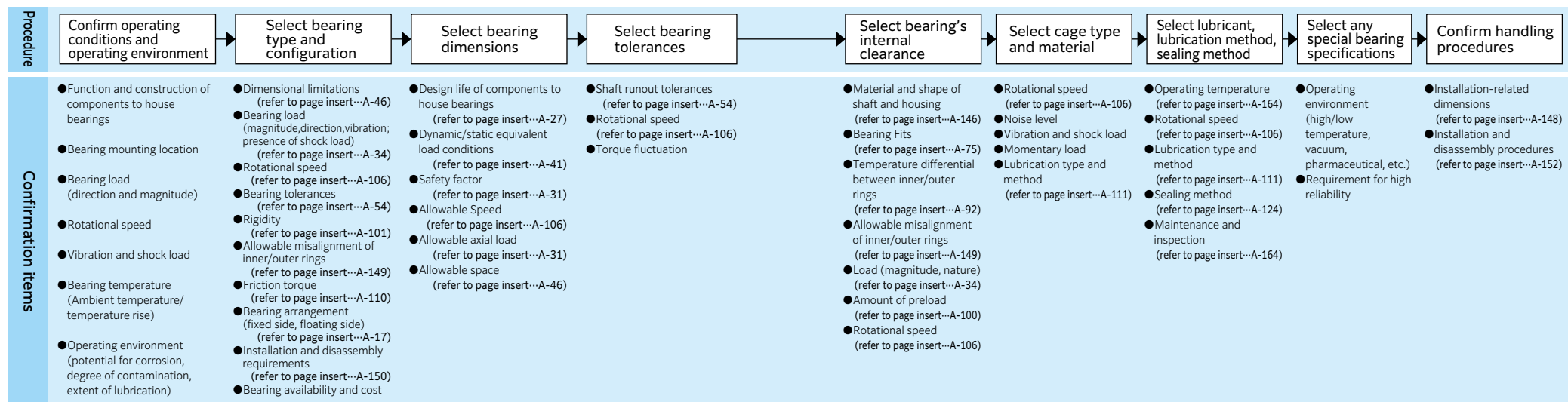

(1) Dimensional limitations
There is a wide range of standardized bearing types and dimensions. Typically, for bearing used in machines, it is necessary to select the optimal bearing type and dimension that fits the space allowed in the machine.

(2) Bearing load
There can be various directions, characteristics, and magnitudes of loading that act on bearings. However, in determining the appropriate bearing type, it is also necessary to consider whether the acting load is a radial load only or combined radial and axial load. In addition, it is necessary to determine what bearing type and size is appropriate based on the basic load rating, specified in the bearing dimension table, while considering the magnitude of the load being applied.

(3) Rotational speed
The allowable speed of a bearing will differ depending upon bearing type, size, tolerances, cage type, load, lubricating conditions, and cooling conditions.

The allowable speeds listed in the bearing tables for grease and oil lubrication are for normal tolerance NTN bearings. In general, deep groove ball bearings, angular contact ball bearings, and cylindrical roller bearings are most suitable for high speed applications.

(4) Bearing tolerances
The dimensional accuracy and operating tolerances of bearings are regulated by ISO and JIS standards.

For equipment requiring high tolerance shaft runout or high speed operation, bearings with Class 5 tolerance or higher are recommended.

Deep groove ball bearings, angular contact ball bearings, and cylindrical roller bearings are recommended for high rotational tolerances.

(5) Rigidity
Elastic deformation occurs along the contact surfaces of a bearing's rolling elements and raceway surfaces under loading. With certain types of equipment it is necessary to reduce this deformation as much as possible. In general, roller bearings exhibit less elastic deformation

than ball bearings. Furthermore, in some cases, bearings are given a load in advance (preloaded) to increase their rigidity. This procedure is commonly applied to deep groove ball bearings, angular contact ball bearings, and tapered roller bearings.

(6) Misalignment of inner and outer rings
Shaft flexure, variations in shaft or housing accuracy, and fitting errors result in a certain degree of misalignment between the bearing's inner and outer rings. In situations where the degree of misalignment is liable to be relatively large, self-aligning ball bearings, spherical roller bearings, bearing units and other bearings with aligning properties are advisable. (Refer to Fig. 2.1)

(7) Noise and torque levels
Rolling bearings are manufactured and processed according to high precision standards, and therefore generally produce only slight amounts of noise and torque. For applications requiring particularly low-noise or low-torque operation, deep groove ball bearings and cylindrical roller bearings are most appropriate.

(8) Installation and disassembly
Some applications require frequent disassembly and reassembly to enable periodic inspections and repairs. For such applications, bearings with separable inner/outer rings, such as cylindrical roller bearings, needle roller bearings, and tapered roller bearings are most appropriate. Incorporation of adapter sleeves simplifies the installation and disassembly of self-aligning ball bearings and spherical roller bearings with tapered bores.

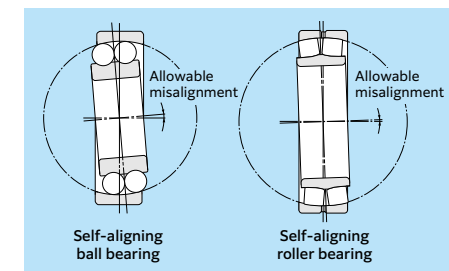

Fig. 2.1

2.2 Type and characteristics

Table 2.1 shows the main types and characteristics of rolling bearings.

Table 2.1 Main types of rolling bearings and performance comparison

Characteristics	Bearing type									
	Deep groove ball bearings	Angular contact ball bearings	Double row angular contact ball bearings	Duplex angular contact ball bearings	Self-aligning ball bearings	Cylindrical roller bearings	Singleflange cylindrical roller bearings	Doubleflange cylindrical roller bearings	Double row cylindrical roller bearings	Needle roller bearings
Radial load	☆☆	☆☆	☆☆☆	☆☆☆	☆☆	☆☆☆	☆☆☆	☆☆☆	☆☆☆☆	☆☆☆
Axial load	☆☆ Both directions	☆☆☆ One direction	☆☆☆ Both directions	☆☆☆ Both directions	☆☆ Both directions	×	☆☆ One direction	☆☆ Both directions	×	×
Combined load	☆☆	☆☆☆	☆☆☆	☆☆☆	☆☆	×	☆☆	☆☆	×	×
High speed rotation ¹⁾	☆☆☆☆	☆☆☆☆	☆☆	☆☆☆	☆☆	☆☆☆☆	☆☆☆☆	☆☆☆	☆☆☆☆	☆☆☆☆
Accuracy under high speed ¹⁾	☆☆☆☆	☆☆☆	☆☆	☆☆☆		☆☆☆☆	☆☆	☆☆	☆☆☆☆	
Low noise/vibration ¹⁾	☆☆☆☆	☆☆☆		☆☆		☆☆	☆☆	☆☆	☆☆	☆☆
Low friction torque ¹⁾	☆☆☆☆	☆☆☆		☆☆	☆☆	☆☆	☆☆	☆☆	☆☆☆☆	☆☆
High rigidity ¹⁾			☆☆	☆☆		☆☆	☆☆	☆☆	☆☆☆☆	☆☆
Vibration/shock resistance ¹⁾			☆☆		×	☆☆	☆☆	☆☆	☆☆☆☆	☆☆
Allowable misalignment for inner/outer rings ¹⁾	☆☆				☆☆☆☆	☆☆				
Stationary in axial direction ²⁾	○	○	○ For DB and DF arrangement	○	○	○	○	○	○	○
Movable in axial direction ³⁾	○		○ For DB arrangement	○	○	○			○	○
Separable of inner and outer rings ⁴⁾					○	○	○	○	○	○
Tapered bore inner ring ⁵⁾						○			○	
Remarks		Duplex arrangement required				NU, N type	NJ, NF type	NUP, NP, NH type	NNU, NN type	NA type
Reference page	B-17	B-57	B-59	B-57	B-79	B-93	B-93	B-93	B-94	E-2

Characteristics	Bearing type						Reference page	Bearing type
	Tapered roller bearings	Double-row, 4-row tapered roller bearings	Spherical roller bearings	Thrust ball bearings	Thrust cylindrical roller bearings	Thrust spherical roller bearings		
Radial load	☆☆☆	☆☆☆☆	☆☆☆☆	×	×	☆☆		Load capacity
Axial load	☆☆☆☆ One direction	☆☆☆☆ Both directions	☆☆☆☆ Both directions	☆☆☆☆ One direction	☆☆☆☆ One direction	☆☆☆☆ One direction		
Combined load	☆☆☆☆	☆☆☆☆	☆☆☆☆	×	×	×		
High speed rotation ¹⁾	☆☆☆☆	☆☆	☆☆	☆☆	☆☆	☆☆	A-106	
Accuracy under high speed ¹⁾	☆☆☆☆	☆☆		☆☆			A-54	
Low noise/vibration ¹⁾				☆☆			—	
Low friction torque ¹⁾							A-110	
High rigidity ¹⁾	☆☆	☆☆☆☆	☆☆☆☆		☆☆☆☆	☆☆☆☆	—	
Vibration/shock resistance ¹⁾	☆☆	☆☆☆☆	☆☆☆☆		☆☆☆☆	☆☆☆☆	A-34	
Allowable misalignment for inner/outer rings ¹⁾	☆☆		☆☆☆☆		×	☆☆☆☆	A-149	
Stationary in axial direction ²⁾	○	○	○	○	○	○	A-17	
Movable in axial direction ³⁾	○	○	○	○			A-17	
Separable of inner and outer rings ⁴⁾	○	○		○	○	○	—	
Tapered bore inner ring ⁵⁾			○				A-147	
Remarks					Including thrust, needle roller bearings		—	
Reference page	B-127	B-128 C-36	B-211	B-253	E-2	B-254		

- ☆☆☆☆ : Particularly excellent
☆☆☆☆ : Excellent
☆☆☆☆ : Highly possible
☆☆ : Possible
× : Poor
- indicates dual direction.
○ indicates single direction axial movement only.
- indicates movement in the axial direction is possible for the raceway surface; ○ indicates movement in the axial direction is possible for the fitting surface of the outer ring or inner ring.
- indicates both inner ring and outer ring are separable.
- indicates inner ring with tapered bore is possible.

2.3 Selection of bearing arrangement

In general, a shaft is supported by two bearings. A bearing that positions and fixes the shaft in the axial direction is called the “**fixed side bearing**” and a bearing that allows the axial movement is called the “**floating side bearing**.” This allows expansion and contraction of the shaft due to temperature variation and absorbs errors in the bearing mounting clearance. Fixing two bearings without providing a floating side bearing applies an excessive load on bearings because of the expansion and contraction or the error, damaging the bearings at an early stage.

The **fixed side bearing** is able to support radial and axial loads. A bearing that can fix axial movement in both directions should therefore be selected. A **floating side bearing** that allows movement in the axial direction while

supporting a radial load is desirable. Movement in the axial direction **occurs on the raceway surface** for bearings with separable inner and outer rings such as **cylindrical roller bearings**, and **occurs on the fitting surface** for those which are not separable, such as **deep groove ball bearings**.

When shaft expansion and contraction due to temperature fluctuations is slight, the same type of bearing may be used for both the fixed-side and floating-side bearing.

Table 2.2 (1) shows typical bearing arrangements where the bearing type differs on the fixed side and floating side. **Table 2.2 (2)** shows some common bearing arrangements where no distinction is made between the fixed side and floating side. Vertical shaft bearing arrangements are shown in **Table 2.2 (3)**.

Table 2.2 (1) Bearing arrangement (distinction between fixed and floating-side)

Arrangement		Remarks	Application (Reference)
Fixed side	Floating side		
		<ol style="list-style-type: none"> 1. General arrangement for small machinery. 2. For radial loads, but will also accept axial loads in some degree. 	Small pumps, auto-mobile transmissions, etc.
		<ol style="list-style-type: none"> 1. Suitable when mounting error and shaft deflection are minimal or used for high rotational speed application. 2. Even with expansion and contraction of shaft, the floating side moves smoothly. 	Medium-sized electric motors, ventilators, etc.
		<ol style="list-style-type: none"> 1. Relatively heavy radial loading and dual direction of axial loading possible. 2. In place of duplex angular contact ball bearings, double-row angular contact ball bearings are also used. 	Worm gears, reducers, compressors
		<ol style="list-style-type: none"> 1. Heavy loading capable. 2. Shafting rigidity increased by preloading the two back-to-back fixed bearings. 3. Requires high precision shafts and housings, and minimal fitting errors. 	Industrial machinery, large reducers
		<ol style="list-style-type: none"> 1. Allows for shaft deflection and fitting errors. 2. By using an adapter on long shafts without screws or shoulders, bearing mounting and dismounting can be facilitated. 3. Self-aligning ball bearings are used for positioning in the axial direction, and not suitable for applications requiring support of axial load. 	Conveyors
		<ol style="list-style-type: none"> 1. Widely used in general industrial machinery with heavy and shock load demands. 2. Allows for shaft deflection and fitting errors in some degree. 3. Accepts radial loads as well as dual direction of axial loads in some degree. 	Industrial machinery, large reducers
		<ol style="list-style-type: none"> 1. Accepts radial loads as well as dual direction axial loads in some degree. 2. Suitable if an inner and outer ring tight fit is required. 	Industrial machinery, large reducers
		<ol style="list-style-type: none"> 1. Capable of handling large radial and axial loads at high rotational speeds. 2. Maintains clearance between the bearing's outer diameter and housing inner diameter to prevent deep groove ball bearings from receiving radial loads. 	Diesel locomotives, carriage axles

Table 2.2 (2) Bearing arrangement (no distinction between fixed and floating-side)

Arrangement		Remarks	Application (Reference)
		<ol style="list-style-type: none"> 1. Back-to-back arrangement is preferable to face to face arrangement when moment load applied. 2. Able to support axial and radial loads; suitable for high-speed rotation. 3. Rigidity of shaft can be enhanced by providing preload. 	Machine tool spindles, etc.
		<ol style="list-style-type: none"> 1. Capable of supporting heavy loads and impact loads. 2. Suitable if an inner and outer ring tight fit is required. 3. Care must be taken so axial clearance does not become too small during operation. 	Construction equipment, mining equipment sheaves, agitators, etc.
		<ol style="list-style-type: none"> 1. Withstands heavy and shock loads. Wide range application. 2. Shaft rigidity can be enhanced by providing preload, but make sure preload is not excessive. 3. Back-to-back arrangement for moment loads, and face-to-face arrangement to alleviate fitting errors. 4. With face-to-face arrangement, inner ring tight fit is facilitated. 	Reduction gears, front and rear axle of automobiles, etc.
 Back-to-back arrangement			
 Face-to-face arrangement			

Table 2.2 (3) Bearing arrangement (Vertical shaft)

Arrangement	Remarks	Application (Reference)
	<ol style="list-style-type: none"> 1. When a fixing bearing is a duplex angular contact ball bearing, the floating bearing should be a cylindrical roller bearing. 	Vertically mounted electric motors, etc.
	<ol style="list-style-type: none"> 1. Most suitable arrangement for very heavy axial loads. 2. Shaft deflection and mounting error can be absorbed by matching the center of the spherical surface with the center of spherical roller thrust bearings. 	Crane center shafts, etc.

3. Load rating and life

3.1 Bearing life

Even in bearings operating under normal conditions, the surfaces of the raceway and rolling elements are constantly being subjected to repeated compressive stresses which causes flaking of these surfaces to occur. This flaking is due to material fatigue and will eventually cause bearings to fail.

The effective life of a bearing is usually defined in terms of the total number of revolutions a bearing can undergo before flaking of either the raceway surface or the rolling element surfaces occurs.

Other causes of bearing failure are often attributed to problems such as seizing, abrasions, cracking, chipping, scuffing, rust, etc. However, these so called "causes" of bearing failure are usually themselves caused by improper installation, insufficient or improper lubrication, faulty sealing or improper bearing selection.

Since the above mentioned "causes" of bearing failure can be avoided by taking proper precautions, and are not simply caused by material fatigue, they are considered separately from the flaking aspect.

3.2 Basic rating life and basic dynamic load rating

A group of seemingly identical bearings when subjected to identical loads and operating conditions will exhibit a wide diversity in their durability. This "life" disparity can be accounted for by the difference in the fatigue of the bearing material itself.

This disparity is considered statistically when calculating bearing life, and the basic rating life is defined as follows.

The basic rating life is based on a 90% statistical model which is expressed as the total number of revolutions 90% of the bearings in an identical group of bearings

subjected to identical operating conditions will attain or surpass before flaking due to material fatigue. For bearings operating at fixed constant speeds, the basic rating life (90% reliability) is expressed in the total number of hours of operation. Basic dynamic load rating expresses a rolling bearing's capacity to support a dynamic load.

The basic dynamic load rating is the load which a bearing can theoretically endure for a basic rating life of one million revolutions. This is expressed as pure radial load for radial bearings and pure axial load for thrust bearings. These are referred to as "basic dynamic radial load rating (C_r)" and "basic dynamic axial load rating (C_a)."

The basic dynamic load ratings given in the bearing tables of this catalog are for bearings constructed of NTN high quality bearing materials and of good manufacturing quality.

The relationship between the basic rating life, the basic dynamic load rating and the dynamic equivalent load is shown in formulas (3.1) and (3.2).

$$\text{For ball bearings : } L_{10} = \left(\frac{C}{P}\right)^3 \dots \dots \dots (3.1)$$

$$\text{For roller bearings: } L_{10} = \left(\frac{C}{P}\right)^{10/3} \dots \dots (3.2)$$

Where:

L_{10} : Basic rating life 10^6 revolutions

C : Basic dynamic load rating N

Radial bearing C_r

Thrust bearing C_a

P : Dynamic equivalent load $N^{1)}$

Radial bearing P_r

Thrust bearing P_a

1) For more details, please refer to the section "4. Bearing load calculation."

The relationship between rotational speed n and speed factor f_n as well as the relationship between life factor f_h and basic rating life L_{10h} are shown in Table 3.1 and Fig. 3.1.

Table 3.1 Bearing basic rating life, life factor, and speed factor

Division	Ball bearing	Roller bearing
Basic rating life L_{10h} h	$\frac{10^6}{60n} \left(\frac{C}{P}\right)^3 = 500 f_h^3$	$\frac{10^6}{60n} \left(\frac{C}{P}\right)^{10/3} = 500 f_h^{10/3}$
Life factor f_h	$f_n \frac{C}{P}$	$f_n \frac{C}{P}$
Speed factor f_n	$\left(\frac{33.3}{n}\right)^{1/3}$	$\left(\frac{33.3}{n}\right)^{3/10}$

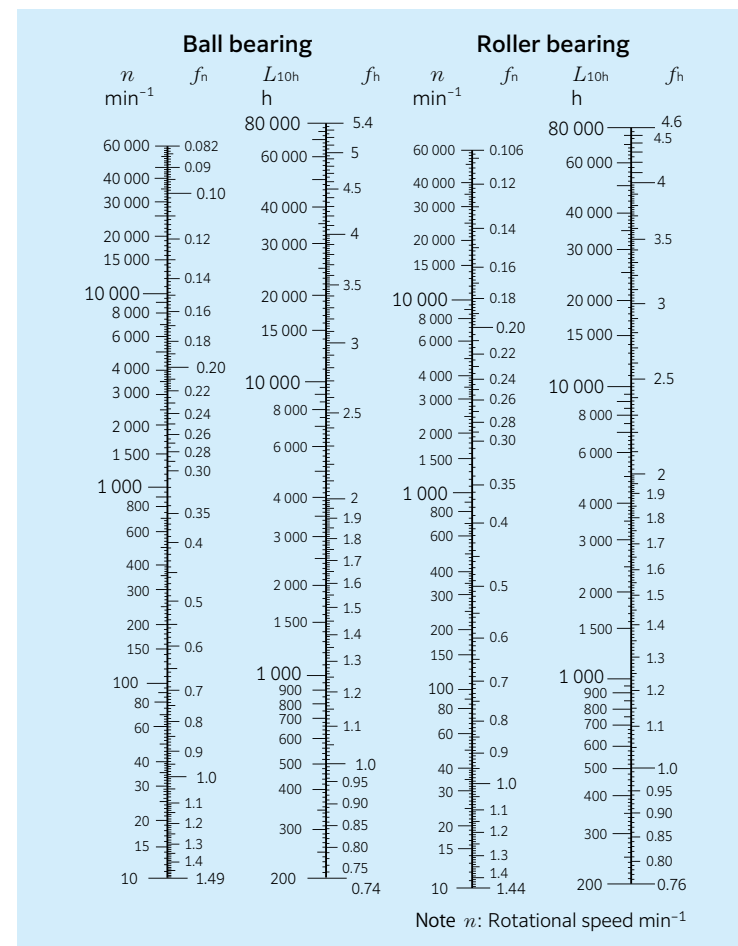

Fig. 3.1 Bearing life rating scale

When several bearings are incorporated in machines or equipment as complete units, all the bearings in the unit are considered as a whole when computing bearing system life (see formula 3.3).

$$L = \frac{1}{\left(\frac{1}{L_1^e} + \frac{1}{L_2^e} + \dots + \frac{1}{L_n^e}\right)^{1/e}} \dots\dots\dots (3.3)$$

Where:

L : Total basic rating life of entire unit, h

$L_1, L_2 \dots L_n$: Basic rating life of individual bearings 1, 2, ..., n, h

e : $e = 10/9$ For ball bearings

$e = 9/8$ For roller bearings

When the load conditions vary at regular intervals, the life can be given by formula (3.4).

$$L_m = \left(\frac{\phi_1}{L_1} + \frac{\phi_2}{L_2} + \dots + \frac{\phi_j}{L_j}\right)^{-1} \dots\dots\dots (3.4)$$

Where:

L_m : Total life of bearing, h

ϕ_j : Frequency of individual load conditions ($\sum \phi_j = 1$)

L_j : Life under individual conditions, h

If dynamic equivalent load P and rotational speed n are operating conditions of the bearing, basic rated dynamic load C that satisfies required life of the bearing is determined using **Table 3.1** and formula (3.5). Bearings that satisfy the required C can be selected from the bearing dimensions table provided in the catalog.

$$C = P \frac{f_h}{f_n} \dots\dots\dots (3.5)$$

3.3 Adjusted rating life

The basic bearing rating life can be calculated through the formulas mentioned earlier in Section 3.2. However, in some applications bearing reliability higher than 90% may be

required. In addition, bearing life may be enhanced by the use of specialty bearing materials or manufacturing processes. Bearing life is also sometimes affected by operating conditions such as lubrication, temperature and rotational speed.

Basic rating life adjusted to compensate for reliability, special bearing materials and enhancements, and specific operation conditions is called "**adjusted rating life**," and is determined using formula (3.6).

$$L_{na} = a_1 \cdot a_2 \cdot a_3 \cdot L_{10} \dots\dots\dots (3.6)$$

Where:

L_{na} : Adjusted rating life in millions of revolutions (10^6)

a_1 : Life adjustment factor for reliability

a_2 : Life adjustment factor for special bearing properties

a_3 : Life adjustment factor for operating conditions

3.3.1 Life adjustment factor for reliability a_1

The value of **life adjustment factor for reliability a_1** is provided in **Table 3.2** for reliability of 90% or greater.

3.3.2 Life adjustment factor for special bearing properties a_2

Bearing characteristics concerning life vary according to bearing material, quality of material and if using a special manufacturing process. In this case, life is adjusted using **life adjustment factor for special bearing properties a_2** .

The basic dynamic load ratings listed in the catalog are based on **NTN's** standard material and the adjustment factor used is $a_2 = 1$.

However, an adjustment factor of a_2 other than 1 may be used for bearings with specially enhanced materials and manufacturing methods.

[NOTE: $a_2 < 1$ may occur for temperature stabilization]

$a_2 > 1$ may be used for bearings with specially improved materials and manufacturing methods.

Bearings made of high carbon chrome bearing steel, conventionally heat treated, may experience dimensional changes during operation if used at high temperatures for extended periods of time. Temperature stabilization treatment (**TS treatment**) can be used to provide increased dimensional stability of bearing materials at high operational temperatures. However, the dimensional stabilization treatment results in a lower overall hardness of heat treated bearing materials; therefore, the life is adjusted by multiplying by life adjustment factor for special bearing properties a_2 given in **Table 3.3**.

For further clarification please consult with **NTN Engineering**.

Table 3.2 Life adjustment factor for reliability a_1

Reliability %	L_n	Life adjustment factor for reliability a_1
90	L_{10}	1.00
95	L_5	0.64
96	L_4	0.55
97	L_3	0.47
98	L_2	0.37
99	L_1	0.25
99.2	$L_{0.8}$	0.22
99.4	$L_{0.6}$	0.19
99.6	$L_{0.4}$	0.16
99.8	$L_{0.2}$	0.12
99.9	$L_{0.1}$	0.093
99.92	$L_{0.08}$	0.087
99.94	$L_{0.06}$	0.080
99.95	$L_{0.05}$	0.077

Table 3.3 Treatment for dimensional stabilization

Code	Max. operating temperature °C	Life adjustment factor for special bearing properties a_2
TS2	160	1.00
TS3	200	0.73
TS4	250	0.48

Please consult **NTN Engineering** for life adjustment factor for special bearing properties (a_2) when using dimensional stabilization treatment combined with any specialty bearing material.

3.3.3 Life adjustment factor for operating conditions a_3

Life adjustment factor for operating conditions a_3

a_3 is used to compensate for when lubrication condition worsens due to a rise in temperature or rotational speed, lubricant deteriorates or it becomes contaminated with foreign matter.

Generally speaking, when lubricating conditions are satisfactory, the a_3 factor has a value of 1.0; and when lubricating conditions are exceptionally favorable, and all other operating conditions are normal, a_3 can have a value greater than 1.0. The factor a_3 may be less than 1.0 due to the following cases:

- Dynamic viscosity of lubrication is too low for bearing operating temperature (13 mm²/s or less for ball bearings, 20 mm²/s or less for roller bearings as a standard)
- Rotational speed is particularly low (when the product of pitch diameter D_{pw} mm and rotational speed n min⁻¹ is $D_{pw} \cdot n < 10\,000$)
- Lubricant contaminated with foreign matter or moisture

If using a special operating condition, consult with **NTN Engineering**.

The operating life may be also shortened by misalignment and operating clearance but these operating conditions are not accounted for by the a_3 factor. (See sections "3.7 Misalignment angle (installation error) and life" and "3.8 Clearance and life.")

Even if $a_2 > 1$ is used for specialty bearings made of enhanced materials or produced by special manufacturing methods, $a_2 \times a_3 < 1$ is used if lubricating conditions are not favorable.

When an excessively heavy load is applied, harmful plastic distortion may result at the contact surfaces between the rolling elements and raceways. The formulae for determining basic rating life (3.1, 3.2, and 3.6) do not apply if P_r exceeds either C_{0r} (basic static load rating) or $0.5 C_r$ for radial bearings, or if P_a exceeds $0.5 C_a$ for thrust bearings.

3.4 Modified rating life

3.4.1 Background

Adjusted rating life L_{na} of bearings is as shown in formula (3.6). System conditions corresponding to a_2 and a_3 are considered independently in that approach. However, it is desirable to consider the integrated system as a whole, resulting in adoption of ISO281:2007. This approach considers **life modification factor a_{ISO}** , which provides a more practical method to consider the influence of lubrication, contamination and fatigue load on bearing life. Based on these decisions in ISO 281, JIS B 1518 was similarly revised in 2013.

Modified rating life L_{nm} using life modification factor a_{ISO} can be obtained by formula (3.7).

$$L_{nm} = a_1 \cdot a_{ISO} \cdot L_{10} \dots\dots\dots (3.7)$$

3.4.2 Life modification factor a_{ISO}

The life modification factor, a_{ISO} , is a function of lubrication, contamination, material characteristics, and load as shown in formula 3.8.

$$a_{ISO} = f \left(\frac{e_c C_u}{P}, \kappa \right) \dots\dots\dots (3.8)$$

Where:

C_u : Fatigue load limit

The fatigue load limit is a load applied on bearings that results in the fatigue limit stress at the maximum loaded contact within the raceway. This depends on the bearing type, internal specifications, quality, and material strength. In ISO 281:2007, 1.5GPa is recommended as contact stress corresponding to C_u for the bearings made of commonly used high quality material and good manufacturing quality. The fatigue load limit values with respect to the **NTN** bearing numbers are specified in each specification table.

e_c : Contamination factor

The presence of hard particle contaminants in the lubricant (oil) have the potential to form indentations on the raceway surface, resulting in surface initiated damage and in reduction in bearing life. Contamination factor e_c considers this and depends on the level of contamination, bearing size, and lubricant viscosity (oil film thickness). As shown in **Table 3.4**, approximate values are determined by the bearing size (may be substituted by rolling element pitch diameter D_{pw} , average bearing diameter $(d + D)/2$), filtration and seal structures (including presence of pre-washing).

κ : Viscosity ratio

Bearings are used on the assumption that the rolling contact surface is separated by the lubricant. However, when the viscosity of the lubricant is low, separation becomes insufficient and metal to metal contact occurs, causing surface initiated damage. Viscosity ratio κ considers this effect and is represented by formula (3.9) by the ratio of dynamic viscosity ν in use with respect to reference dynamic viscosity ν_1 of the lubricant.

$$\kappa = \nu / \nu_1 \dots\dots\dots (3.9)$$

Reference dynamic viscosity ν_1 depends on rotation speed n and size (D_{pw}), and can be obtained by **Fig. 3.2** or formula (3.10) and formula (3.11).

Table 3.4 Value of contamination factor e_c

Level of contamination	e_c	
	$D_{pw} < 100\text{mm}$	$D_{pw} \geq 100\text{mm}$
Extreme cleanliness Particle size of the order of lubricant film thickness; laboratory conditions	1	1
High cleanliness Oil filtered through extremely fine filter; conditions typical of bearing greased for life and sealed	0.8~0.6	0.9~0.8
Normal cleanliness Oil filtered through fine filter; conditions typical of bearings greased for life and shielded	0.6~0.5	0.8~0.6
Slight contamination Slight contamination in lubricant	0.5~0.3	0.6~0.4
Typical contamination Conditions typical of bearings without integral seals; course filtering; wear particles and ingress from surroundings	0.3~0.1	0.4~0.2
Severe contamination Bearing environment heavily contaminated and bearing arrangement with inadequate sealing	0.1~0	0.1~0
Very severe contamination	0	0

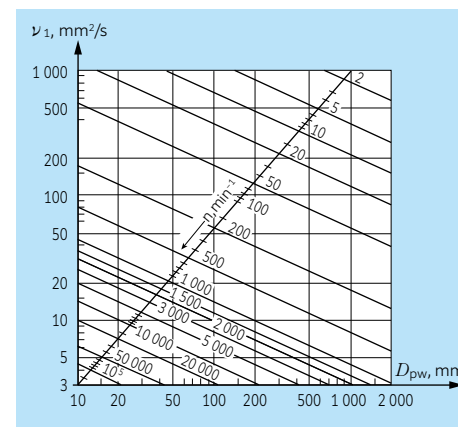

Fig. 3.2 Diagram for reference dynamic viscosity ν_1

In the case of $n < 1000 \text{min}^{-1}$,

$$\nu_1 = 45\,000 n^{-0.83} D_{pw}^{-0.5} \dots\dots\dots (3.10)$$

In the case of $n \geq 1000 \text{min}^{-1}$,

$$\nu_1 = 4\,500 n^{-0.5} D_{pw}^{-0.5} \dots\dots\dots (3.11)$$

Fig. 3.3 shows the relationship among C_u/P , e_c , κ and, a_{ISO} of radial ball bearings. Using the figure has the following restrictions:

- 1) For practical use, the life modification factor shall be limited $a_{ISO} \leq 50$.
- 2) In the case of $\kappa > 4$, $\kappa = 4$ shall be assumed. The same approach does not apply in the case of $\kappa < 0.1$.

Diagrams for radial roller bearings, thrust ball bearings, and thrust roller bearing have also been presented (**Figs. 3.4 to 3.6**). The diagrams can be applied regardless of lubrication types; however, for grease lubrication, special additives, and special rotating behaviors, consult with **NTN Engineering**.

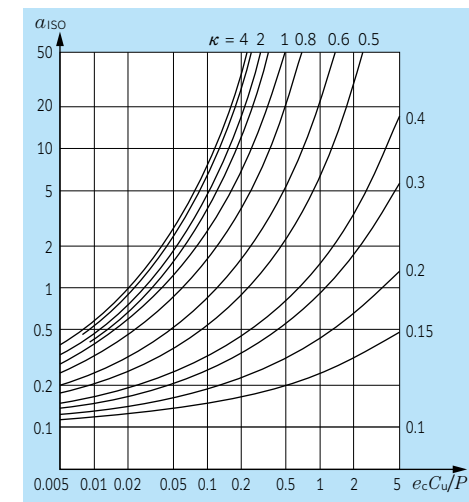

Fig. 3.3 Life modification factor a_{ISO} (radial ball bearing)

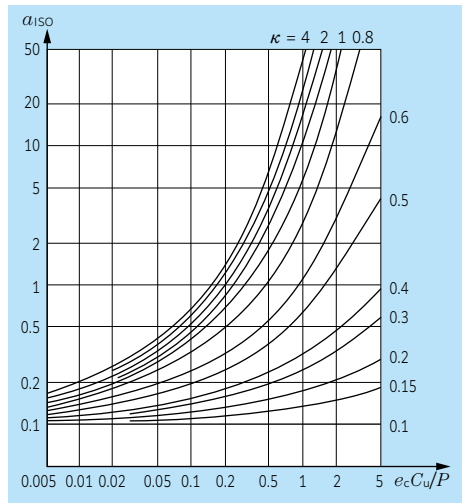

Fig. 3.4 Life modification factor a_{ISO} (radial roller bearing)

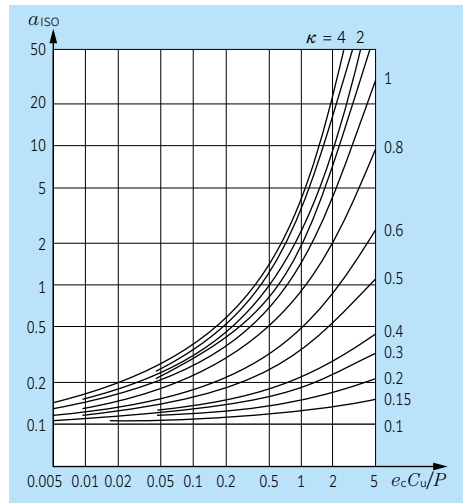

Fig. 3.6 Life modification factor a_{ISO} (thrust roller bearing)

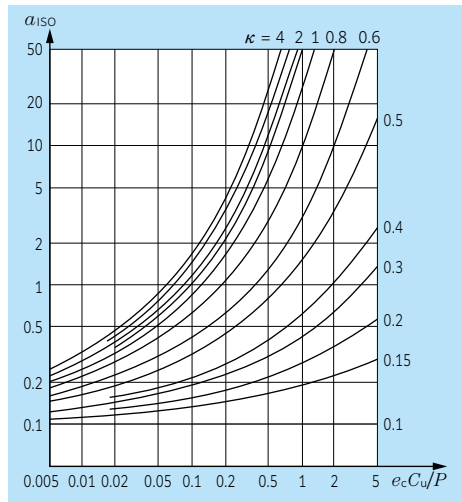

Fig. 3.5 Life modification factor a_{ISO} (thrust ball bearing)

3.4.3 Applicable bearings of modified rating life

Fatigue load limit C_u used for the calculation of life modification factor a_{ISO} depends on the bearing materials. NTN bearings that have undergone standard through hardening (immersion quenching) and is made of bearing steel, the fatigue load limit value with respect to each bearing number is specified in each dimension table, and a_{ISO} can be applied.

3.5 Machine applications and requisite life

When selecting a bearing, it is essential that the requisite life of the bearing be established in relation to the operating conditions. The requisite life of the bearing is usually determined by the type of machine in which the bearing will be used, and duration of service and operational

reliability requirements. A general guide to these requisite life criteria is shown in **Table 3.5**.

When determining bearing size, the fatigue life of the bearing is an important factor; however, besides bearing life, the strength and rigidity of the shaft and housing must also be taken into consideration.

Table 3.5 Machine application and requisite life (reference)

Service classification	Machine application and requisite life L_{10h} ×10 ³ hours				
	Up to 4	4 to 12	12 to 30	30 to 60	60 or more
Machines used for short periods or used only occasionally	Household appliances Electric hand tools	Farm machinery Office equipment			
Short period or intermittent use, but with high reliability requirements	Medical appliances Measuring instruments	Home air-conditioning motor Construction equipment Elevators Cranes	Crane (sheaves)		
Machines not in constant use, but used for long periods	Automobiles Two-wheeled vehicles	Small motors Buses/trucks General gear drives Woodworking machines	Machine spindles Industrial motors Crushers Vibrating screens	Main gear drives Rubber/plastic Calender rolls Printing machines	
Machines in constant use over 8 hours a day		Roll neck of steel mill Escalators Conveyors Centrifuges	Railway vehicle axles Air conditioners Large motors Compressor pumps	Locomotive axles Traction motors Mine hoists Pressed flywheels	Papermaking machines Propulsion equipment for marine vessels
24 hour continuous operation, non-interruptible					Water supply equipment Mine drain pumps/ventilators Power generating equipment

3.6 Weibull distribution and life adjustment factor for reliability

As described in “3.2 Basic rating life and basic dynamic load rating,” a group of seemingly identical bearings when subjected to an identical load and operating conditions may exhibit a wide variation in their durability. In general, this variation is known to follow the “Weibull distribution,” and the basic theory is constructed on the premise that the bearing operating life follows the Weibull distribution also regarding the life calculation formulae (3.1) and (3.2) and the calculation formula of the basic dynamic load rating C .

As an index representing the variation of

the Weibull distribution, there is a coefficient called a Weibull slope. A value 10/9 for ball bearings and 9/8 for roller bearings are given in the basic life calculation theory of ISO and JIS. According to this, for example, for a deep groove ball bearing, a difference of 5 times or more is generated between the L_{10} life of 90% reliability and the L_{50} life of 50% reliability.

In some applications where a bearing is used, a life study with reliability exceeding 90% may be required, and in such a case, a life adjustment factor for reliability a_1 is used. In the latest ISO (ISO 281:2007) and JIS (JIS B 1518:2013), a_1 values were updated based on measured test data (see Fig. 7). Table 3.2 shows the latest a_1 values after review.

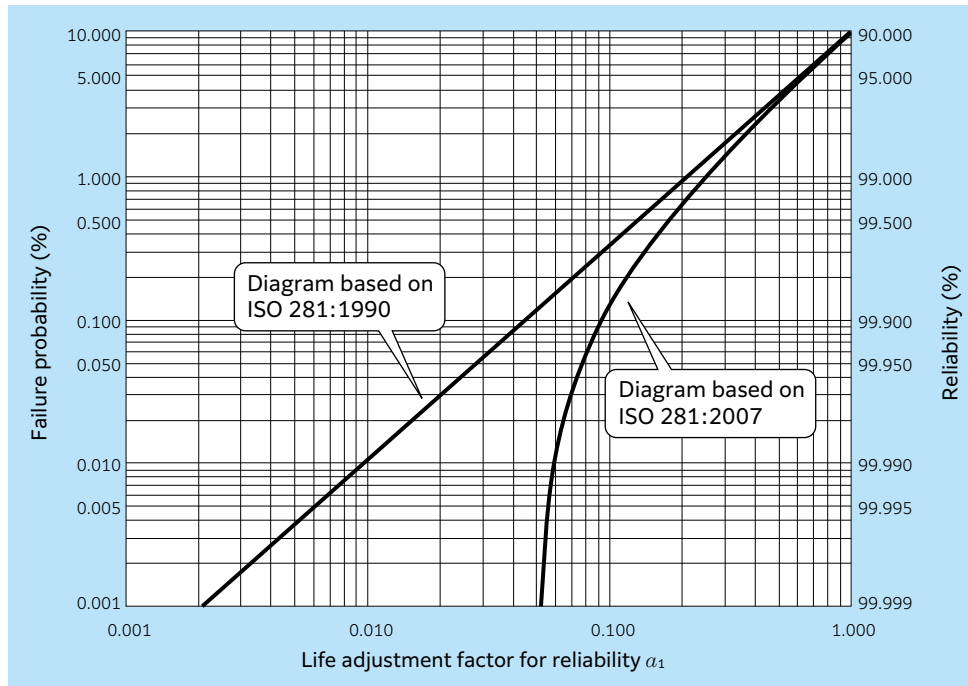

Fig. 7 Life adjustment factor for reliability a_1

3.7 Misalignment angle (installation error) and life

A lack of accuracy and/or rigidity of the shaft or housing can cause misalignment between the bearing inner and outer rings similar to an externally applied moment load.

The bearing operating life calculation in the case of receiving a moment load cannot be obtained by the commonly used $L = (C_r / P_r)^P$, which is generally used, and it is necessary to obtain it considering the internal design, clearance, etc. of each bearing.

Since the life decrease rate differs depending on the internal clearance, the load condition, and the internal design, it is necessary to calculate the ratio under individual conditions, and the rate cannot be given as a factor in general.

Fig. 3.8 and Fig. 3.9 show the results of detailed calculation of the relationship between the misalignment angle (installation error) and the life of a deep groove ball bearing and a cylindrical roller bearing.

See Table 14.6 in section “14. Shaft and housing design” for the rough standard of allowable misalignment and allowable misalignment of each bearing type.

For further clarification please consult with NTN Engineering.

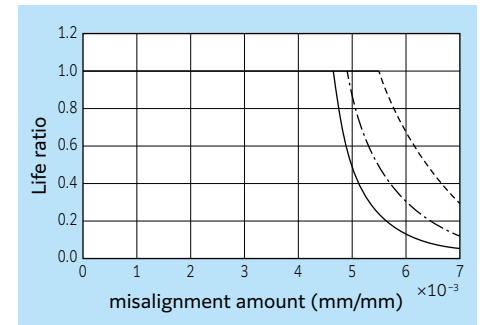

Fig. 3.8 Misalignment angle and life ratio of deep groove ball bearing

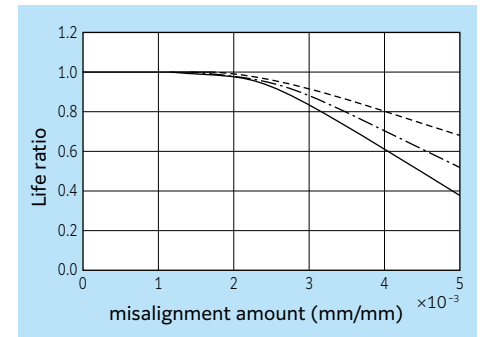

Fig. 3.9 Misalignment angle and life ratio of cylindrical roller bearing

—	Light load
- - -	Normal load
· · ·	Heavy load

3.8 Clearance and life

It is very difficult to accurately determine what the clearance of a rolling bearing should be in a normal operating state.

When a bearing is subjected to a simple load and full rotation slight clearance is preferable. However, too large of a clearance can cause life deterioration and vibration. In contrast, a negative clearance (preload) can extend the operating life and prevent shaft runout. However, too large of a preload increases friction, temperature rise, lubrication degradation and can cause seizures in extreme cases.

As a general guideline a target of zero operating clearance should be acceptable.

1) Clearance and rolling element load W

- (1) In the case of bearing clearance larger than 0 [Fig. 3.11], load distribution $\varepsilon < 0.5$ holds. The maximum rolling element load becomes larger than when the bearing clearance is zero [Fig. 3.10].

[Load factor ε and conceptual diagram]

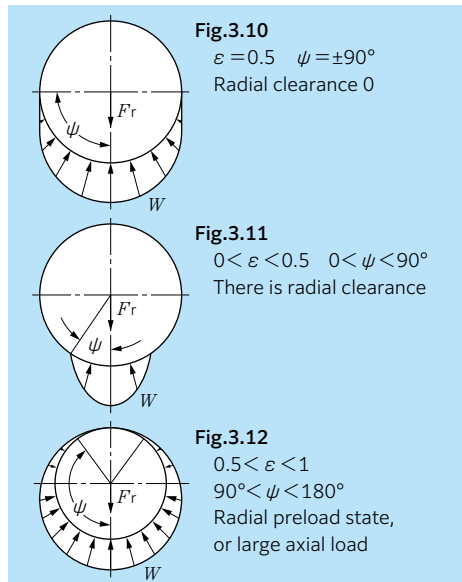

- (2) Fig. 3.13 shows an ideal graph in which operating in a slightly preloaded condition results in maximum bearing life.

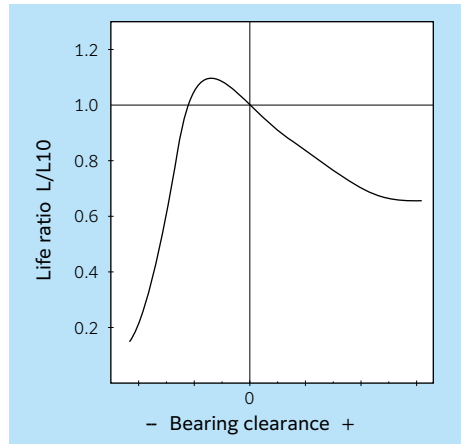

Fig. 3.13 Bearing clearance and life ratio

3.9 Basic static load rating

It has been found through experience that a permanent deformation of 0.0001 times the diameter of the rolling element, occurring at the most heavily stressed contact point between the raceway and the rolling elements, can be tolerated without any subsequent impairment of bearing operation.

Testing indicates the above level of permanent deformation corresponds to a calculated contact stress as shown below. The basic static load rating is defined as the static applied load which results in such a contact stress at the center of the contact patch between the raceway and the rolling element receiving the maximum load.

- Roller bearings: 4 000 MPa
- Ball bearings (excluding self-aligning ball bearings): 4 200 MPa
- Self-aligning ball bearings: 4 600 MPa

Referred to as “basic static radial load rating” for radial bearings and “basic static axial load rating” for thrust bearings, the basic static load rating is expressed as C_{0r} or C_{0a} respectively and is provided in the bearing dimensions table.

3.10 Allowable static equivalent load

Generally the static equivalent load which can be permitted (See page A-41) is limited by the basic static load rating as stated in Section 3.9. However, depending on application requirements regarding friction and smooth operation, these limits may be greater or lesser than the basic static load rating.

This is generally determined by taking the safety factor S_0 given in formula (3.12) and guidelines of Table 3.6 into account.

$$S_0 = C_0 / P_0 \dots\dots\dots (3.12)$$

Where:

- S_0 : Safety factor
- C_0 : Basic static load rating, N
 - Radial bearing: C_{0r}
 - Thrust bearing: C_{0a}
- P_0 : Static equivalent load, N
 - Radial bearing: P_{0r}
 - Thrust bearing: P_{0a}

Table 3.6 Minimum safety factor values S_0

Operating conditions	Ball bearing	Roller bearing
Applications that require quiet rotation	2	3
Applications subjected to impact loads	1.5	3
Normal rotation applications	1	1.5

- Note:
- For spherical thrust roller bearings, min. S_0 value = 4.
 - For shell needle roller bearings, min. S_0 value = 3. However, for premium shells (see the catalog: CAT. No. 3029/JE), min. S_0 value = 2.
 - When vibration and/or shock loads are present, a load factor based on the shock load needs to be included in the P_0 max value.
 - If a large axial load is applied to deep groove ball bearings or angular ball bearings, the contact ellipse may exceed the raceway surface. For more information, please contact NTN Engineering.
 - When an AS type raceway washer is used in a thrust bearing, min. S_0 value = 3.

3.11 Allowable axial load

Radial bearings can also receive axial loads, but load is limited depending on the bearing type.

(1) Ball bearing

When an axial load acts on ball bearings, such as deep groove ball bearings and angular contact ball bearings, the contact angle changes with the load. The contact ellipse formed between the ball and the raceway surface may protrude from the groove when the load exceeds the allowable range.

This contact surface has an elliptical shape in which 1/2 the major diameter becomes a as shown in Fig. 3.14. The maximum allowable axial load is the maximum applied load in which the contact ellipse does not exceed the shoulder of the raceway groove. It is important to note that the axial load must result in $P_{max} < 4200$ MPa even if the contact ellipse does not exceed the shoulder of the groove. The allowable axial load differs depending on the bearing internal clearance, groove curvature, and groove shoulder dimension.

When a combination radial and axial load is applied, verify truncation does not occur at the maximum loaded rolling element.

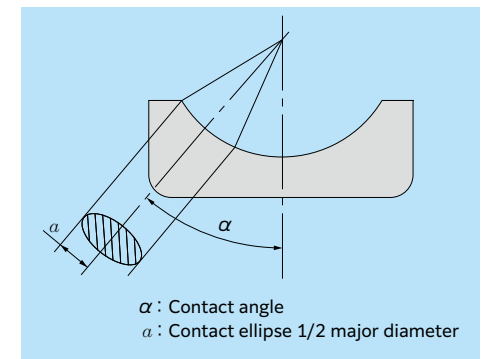

Fig. 3.14 Contact ellipse

(2) Tapered roller bearing (Fig. 3.15)

A tapered roller bearing supports axial load at the raceway surface and at the interface between the roller end face and large end rib. Therefore, the bearing can receive a larger axial force by increasing the contact angle α . However, there are different limits depending on the rotational speed and lubrication conditions because sliding contact occurs between the roller large end face and the large end rib inside face. Generally, the PV value, which is obtained by multiplying the sliding speed to the sliding surface pressure, is checked and calculated by a computer.

For further clarification please consult with NTN Engineering.

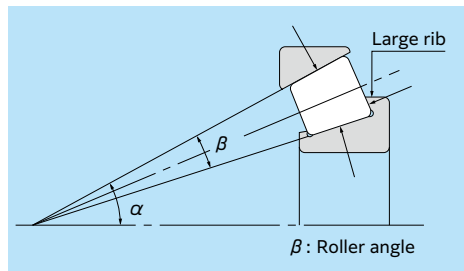

Fig. 3.15 Tapered roller bearings

(3) Cylindrical roller bearings

Cylindrical roller bearings with ribs on the inner and outer rings are capable of simultaneously supporting a certain degree of radial and axial loads. Unlike basic dynamic load ratings which are based on rolling fatigue, allowable axial load is determined by heat generated at the sliding surface between the ends of the rollers and rib which may cause wear and/or seizure. Based on testing and experience, allowable axial load can be estimated using formula (3.13).

$$P_t = k \cdot d^2 \cdot P_z \dots\dots\dots (3.13)$$

Where:

- P_t : Allowable axial load when rotating N
- k : Factor determined by internal design of bearing (see Table 3.7)
- d : Bearing bore mm
- P_z : Allowable surface pressure of rib MPa (see Fig. 3.16)

If the axial load is greater than the radial load, the rollers will not rotate properly. The allowable axial load therefore must not exceed the value for $F_{a \max}$ given in Table 3.7.

The following are also important to operate the bearing smoothly under an axial load:

- 1) Do not make the internal radial clearance any larger than necessary because it may affect life and abrasion between the raceway surface and the roller.
- 2) Use lubricant with an extreme pressure additive to suppress heat generation, seizure, and abrasion between the roller end surface and the rib.
- 3) Make the shoulder of the housing and shaft high enough for the rib of the bearing to prevent it from being damaged.
- 4) If the bearing is to support an extreme axial load, mounting precision should be improved and the bearing should be rotated slowly before actual use.

If large cylindrical roller bearings (bore of 300 mm or more) are to support an axial load or moment load simultaneously, please contact NTN Engineering.

NTN Engineering also offers cylindrical roller bearings for high axial loads (HT type). For details, please contact NTN Engineering.

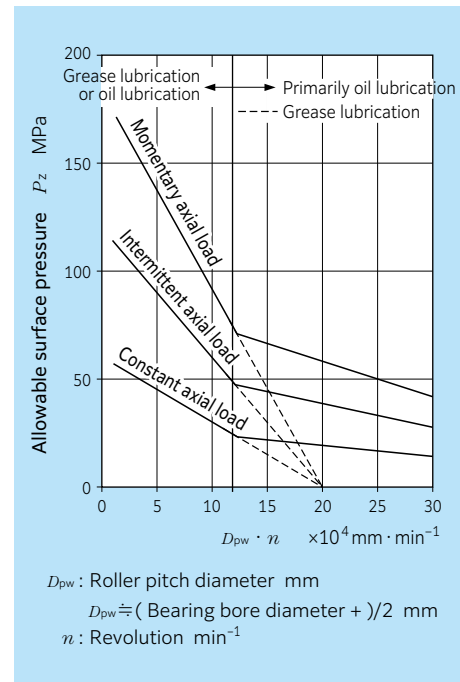

Fig. 3.16 Allowable surface pressure of rib

Table 3.7 Factor k values and allowable axial load ($F_{a \max}$)

Bearing series	k	$F_{a \max}$
NJ, NUP10	0.040	$0.4F_r$
NJ, NUP, NF, NH2, NJ, NUP, NH22		
NJ, NUP, NF, NH3, NJ, NUP, NH23		
NJ, NUP, NH2EA (E) NJ, NUP, NH22EA (E)	0.050	$0.4F_r$
NJ, NUP, NH3EA (E) NJ, NUP, NH23EA (E)	0.080	$0.4F_r$
NJ, NUP, NH4,	0.100	$0.4F_r$
SL01-48	0.022	$0.2F_r$
SL01-49	0.034	$0.2F_r$
SL04-50	0.044	$0.2F_r$

Note: Type EA and type E have the same value.

3.12 Review of basic dynamic load ratings

As a result of continuous improvement related to material cleanliness, and production techniques, years of in-house durability testing has confirmed NTN bearings produced today have a longer operating life compared with past products. Based on this bearing life test data, the basic dynamic load ratings of ball and roller bearings were reviewed and updated to more accurately reflect true bearing performance.

The basic dynamic load ratings for many NTN products have been formally increased and can be found in the dimensional tables for each bearing type within this catalog.

* Some bearings use the same basic dynamic load rating as conventional products.

3.13 Bearing life calculation tool

The basic rating life of bearings can be calculated using the bearing technical calculation tool on the NTN website (<https://www.ntnglobal.com/tool/calc/>).

4. Bearing load calculation

To compute bearing loads, the forces which act on the shaft being supported by the bearing must be determined. Loads which act on the shaft and its related parts include weight of the rotating components, load produced when the machine performs work, and load produced by transmission of dynamic force. These can be mathematically calculated, but calculation is difficult in many cases.

A method of calculating loads that act upon shafts that convey dynamic force, which is the primary application of bearings, is provided herein.

4.1 Load acting on shafts

4.1.1 Load factor

There are many instances where the actual operational shaft load is much greater than the theoretically calculated load, due to shock. This actual shaft load can be estimated by using formula (4.1).

$$K = f_w \cdot K_C \dots\dots\dots (4.1)$$

Where:

K : Actual shaft load N

f_w : Load factor (Table 4.1)

K_C : Theoretically calculated value N

Table 4.1 Load factor f_w

Amount of shock	f_w	Machine application examples
Very little or no shock	1.0 to 1.2	Electric machines, machine tools, measuring instruments.
Light shock	1.2 to 1.5	Railway vehicles, automobiles, rolling mills, metal working machines, paper making machines, printing machines, aircraft, textile machines, electrical units, office machines.
Heavy shock	1.5 to 3.0	Crushers, agricultural equipment, construction equipment, cranes.

4.1.2 Gear load

The loads operating on gears can be divided into three main types according to the direction in which the load is applied; i.e. tangential (K_t), radial (K_s), and axial (K_a). The magnitude and

direction of these loads differ according to the types of gears involved. The following refers to the calculation methods of loads acting on four types of gears.

(1) Loads acting on parallel shaft gears

The forces acting on spur gears and helical gears are depicted in Fig. 4.1 to Fig. 4.3.

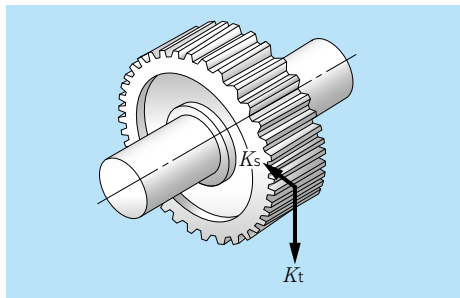

Fig. 4.1 Spur gear loads

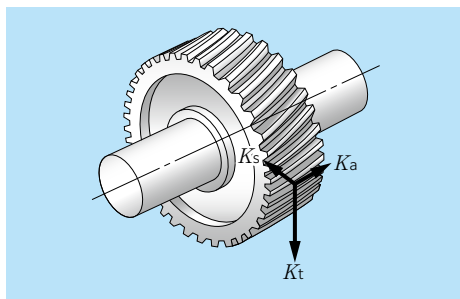

Fig. 4.2 Helical gear loads

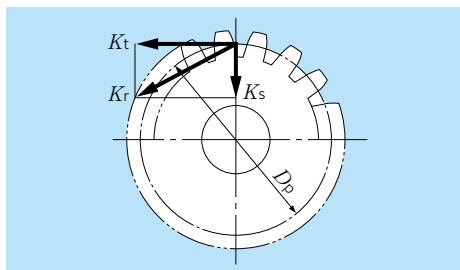

Fig. 4.3 Radial resultant forces

Loads acting on gears are obtained from formulas (4.2) to (4.6).

Equation 4.2 describes the gear load in the tangential direction when the shaft input torque is known

$$K_t = \frac{2T}{D_p} \dots\dots\dots (4.2)$$

Equation 4.3 describes the gear load in the tangential direction when the transmitted power is known

$$K_t = \frac{19.1 \times 10^6 \cdot H}{D_p \cdot n} \dots\dots\dots (4.3)$$

$$K_s = K_t \cdot \tan \alpha \text{ (Spur gear)} \dots\dots\dots (4.4a)$$

$$= K_t \cdot \frac{\tan \alpha}{\cos \beta} \text{ (Helical gear)} \dots\dots\dots (4.4b)$$

$$K_r = \sqrt{K_t^2 + K_s^2} \dots\dots\dots (4.5)$$

$$K_a = K_t \cdot \tan \beta \text{ (Helical gear)} \dots\dots\dots (4.6)$$

Where:

K_t : Tangential gear load (tangential force), N

K_s : Radial gear load (separating force), N

K_r : Right angle shaft load (resultant force of tangential force and separating force), N

K_a : Parallel load on shaft, N

T : Input torque, N · mm

H : Transmitted force, kW

n : Rotational speed min⁻¹

D_p : Gear pitch circle diameter, mm

α : Gear pressure angle, deg

β : Helix angle, deg

Because the actual gear load also contains vibrations and shock loads as well, the theoretical load obtained by the above formula can also be adjusted by the gear factor f_z as shown in Table 4.2.

Table 4.2 Gear factor f_z

Gear type	f_z
Precision ground gears (Pitch and tooth profile errors of less than 0.02mm)	1.05 to 1.1
Ordinary machined gears (Pitch and tooth profile errors of less than 0.1mm)	1.1 to 1.3

(2) Loads acting on cross shafts

Gear loads acting on straight tooth bevel gears and spiral bevel gears on cross shafts are shown in Figs. 4.4 and 4.5. The calculation methods for these gear loads are shown in Table 4.3.

Herein, to calculate gear loads for straight bevel gears, the helix angle $\beta = 0$.

The symbols and units used in Table 4.3 are as follows:

K_t : Tangential gear load (tangential force), N

K_s : Radial gear load (separating force), N

K_a : Parallel shaft load (axial load), N

H : Transmitted power, kW

n : Rotational speed min⁻¹

D_{pm} : Mean pitch circle diameter, mm

α : Gear pressure angle, deg

β : Helix angle, deg

δ : Pitch cone angle, deg

Because the two shafts intersect, pinions and gears have the relationship of formula (4.7) and formula (4.8).

$$K_{sp} = K_{ag} \dots\dots\dots (4.7)$$

$$K_{ap} = K_{sg} \dots\dots\dots (4.8)$$

Where:

K_{sp}, K_{sg} : Pinion and Gear separating force, N

K_{ap}, K_{ag} : Pinion and Gear axial load, N

For spiral bevel gears, the direction of the load varies depending on the direction of the helix angle, the direction of rotation, and which side is the driving side or the driven side. The directions for the separating force (K_s) and axial load (K_a) shown in Fig. 4.5 are positive directions. The direction of rotation and the helix angle direction are defined as viewed from the large end of the gear. The gear rotation direction in Fig. 4.5 is assumed to be clockwise (right).

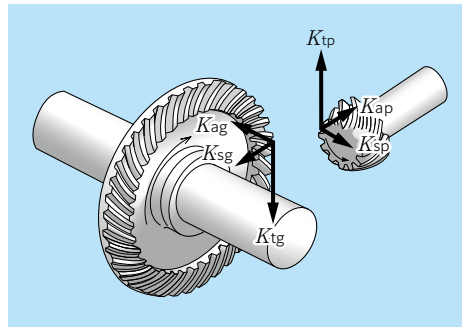

Fig. 4.4 Loads on bevel gears

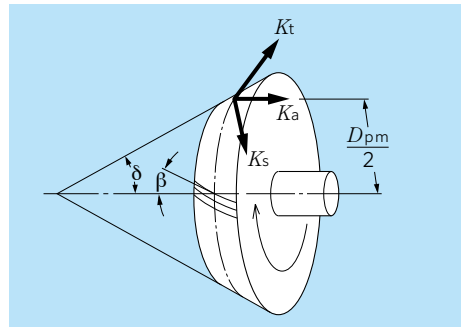

Fig. 4.5 Bevel gear diagram

Table 4.3 Loads acting on bevel gears

Types of load	Rotation direction	Clockwise	Counter clockwise	Clockwise	Counter clockwise
	Helix direction	Right	Left	Left	Right
Tangential load (tangential force) K_t		$K_t = \frac{19.1 \times 10^6 \cdot H}{D_{pm} \cdot n}$			
Radial load (separation force) K_s	Driving side	$K_s = K_t \left[\tan \alpha \frac{\cos \delta}{\cos \beta} + \tan \beta \sin \delta \right]$	$K_s = K_t \left[\tan \alpha \frac{\cos \delta}{\cos \beta} - \tan \beta \sin \delta \right]$	$K_s = K_t \left[\tan \alpha \frac{\cos \delta}{\cos \beta} - \tan \beta \sin \delta \right]$	$K_s = K_t \left[\tan \alpha \frac{\cos \delta}{\cos \beta} + \tan \beta \sin \delta \right]$
	Driven side	$K_s = K_t \left[\tan \alpha \frac{\cos \delta}{\cos \beta} - \tan \beta \sin \delta \right]$	$K_s = K_t \left[\tan \alpha \frac{\cos \delta}{\cos \beta} + \tan \beta \sin \delta \right]$	$K_s = K_t \left[\tan \alpha \frac{\cos \delta}{\cos \beta} + \tan \beta \sin \delta \right]$	$K_s = K_t \left[\tan \alpha \frac{\cos \delta}{\cos \beta} - \tan \beta \sin \delta \right]$
Parallel load on gear shaft (axial load) K_a	Driving side	$K_a = K_t \left[\tan \alpha \frac{\sin \delta}{\cos \beta} - \tan \beta \cos \delta \right]$	$K_a = K_t \left[\tan \alpha \frac{\sin \delta}{\cos \beta} + \tan \beta \cos \delta \right]$	$K_a = K_t \left[\tan \alpha \frac{\sin \delta}{\cos \beta} + \tan \beta \cos \delta \right]$	$K_a = K_t \left[\tan \alpha \frac{\sin \delta}{\cos \beta} - \tan \beta \cos \delta \right]$
	Driven side	$K_a = K_t \left[\tan \alpha \frac{\sin \delta}{\cos \beta} + \tan \beta \cos \delta \right]$	$K_a = K_t \left[\tan \alpha \frac{\sin \delta}{\cos \beta} - \tan \beta \cos \delta \right]$	$K_a = K_t \left[\tan \alpha \frac{\sin \delta}{\cos \beta} - \tan \beta \cos \delta \right]$	$K_a = K_t \left[\tan \alpha \frac{\sin \delta}{\cos \beta} + \tan \beta \cos \delta \right]$

(3) Load acting on hypoid gears

A hypoid gear is a spiral bevel gear that transmits power by offset shafts. Fig. 4.6 shows the load acting on a hypoid gear, and Table 4.4 shows the calculation method.

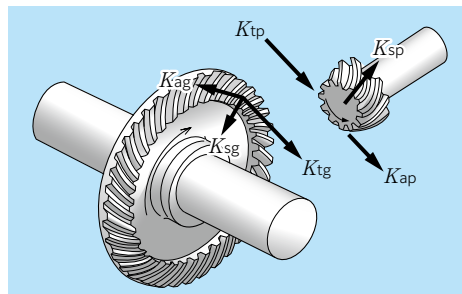

Fig. 4.6

Where:

- K_t : Tangential gear load (tangential force), N
- K_s : Radial gear load (separating force), N
- K_a : Parallel shaft load (axial load), N
- H : Transmitted force, kW
- n : Rotational speed min^{-1}
- D_p : Gear mean pitch circle diameter, mm
- α : Gear pressure angle, deg
- β : Helix angle, deg
- δ_1 : Tooth tip cone angle, deg
- δ_2 : Tooth bottom cone angle, deg
- * The driving shaft has a subscript p , and the driven shaft has a subscript g .

Table 4.4 Formula of load acting on hypoid gears

Types of load	Rotation direction	Clockwise	Counter clockwise	Clockwise	Counter clockwise
	Helix direction	Right	Left	Left	Right
Tangential load (tangential force) K_t	Driving shaft	Formula (4.9)		Formula (4.10)	
	Driven shaft				
Radial load (separation force) K_s	Driving shaft	Formula (4.11)		Formula (4.12)	
	Driven shaft	Formula (4.13)		Formula (4.14)	
Parallel load on gear shaft (axial load) K_a	Driving shaft	Formula (4.15)		Formula (4.16)	
	Driven shaft	Formula (4.17)		Formula (4.18)	

(4) Load acting on worm gears

A worm gear is a gear made by combining a worm (screw gear) and a worm wheel (helical gear). The gear direction differs depending on the rotation direction and the screw direction (right screw, left screw) of the worm shaft.

Fig. 4.8 shows the direction of loads acting on the gear, and Table 4.5 shows the calculation method of the loads.

$$K_{tp} = \frac{19.1 \times 10^6 H}{D_{pmp} n_p} \dots \dots \dots (4.9)$$

$$K_{tg} = \frac{19.1 \times 10^6 H}{D_{pmg} n_g} = \frac{\cos \beta_g}{\cos \beta_p} K_{tp} \dots (4.10)$$

$$K_{sp} = \frac{K_{tp}}{\cos \beta_p} (\tan \alpha_p \cos \delta_{p1} + \sin \beta_p \sin \delta_{p1}) \dots (4.11)$$

$$K_{sp} = \frac{K_{tp}}{\cos \beta_p} (\tan \alpha_p \cos \delta_{p1} - \sin \beta_p \sin \delta_{p1}) \dots (4.12)$$

$$K_{sg} = \frac{K_{tg}}{\cos \beta_g} (\tan \alpha_g \cos \delta_{g2} - \sin \beta_g \sin \delta_{g2}) \dots (4.13)$$

$$K_{sg} = \frac{K_{tg}}{\cos \beta_g} (\tan \alpha_g \cos \delta_{g2} + \sin \beta_g \sin \delta_{g2}) \dots (4.14)$$

$$K_{ap} = \frac{K_{tp}}{\cos \beta_p} (\tan \alpha_p \sin \delta_{p1} - \sin \beta_p \cos \delta_{p1}) \dots (4.15)$$

$$K_{ap} = \frac{K_{tp}}{\cos \beta_p} (\tan \alpha_p \sin \delta_{p1} + \sin \beta_p \cos \delta_{p1}) \dots (4.16)$$

$$K_{ag} = \frac{K_{tg}}{\cos \beta_g} (\tan \alpha_g \sin \delta_{g2} + \sin \beta_g \cos \delta_{g2}) \dots (4.17)$$

$$K_{ag} = \frac{K_{tg}}{\cos \beta_g} (\tan \alpha_g \sin \delta_{g2} - \sin \beta_g \cos \delta_{g2}) \dots (4.18)$$

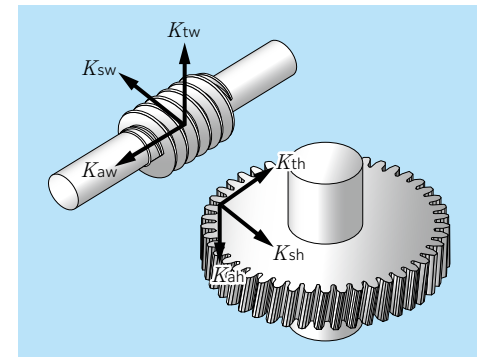

Fig. 4.7 Worm gears

- K_t : Tangential gear load (tangential force), N
- K_s : Radial gear load (separating force), N
- K_a : Parallel shaft load (axial load), N
- H : Transmitted force, kW
- n : Rotational speed min^{-1}
- D_p : Gear mean pitch circle diameter, mm
- α : Gear pressure angle, deg
- γ : Worm lead angle, deg
- * The worm shaft has a subscript w , and the worm gear has a subscript h .

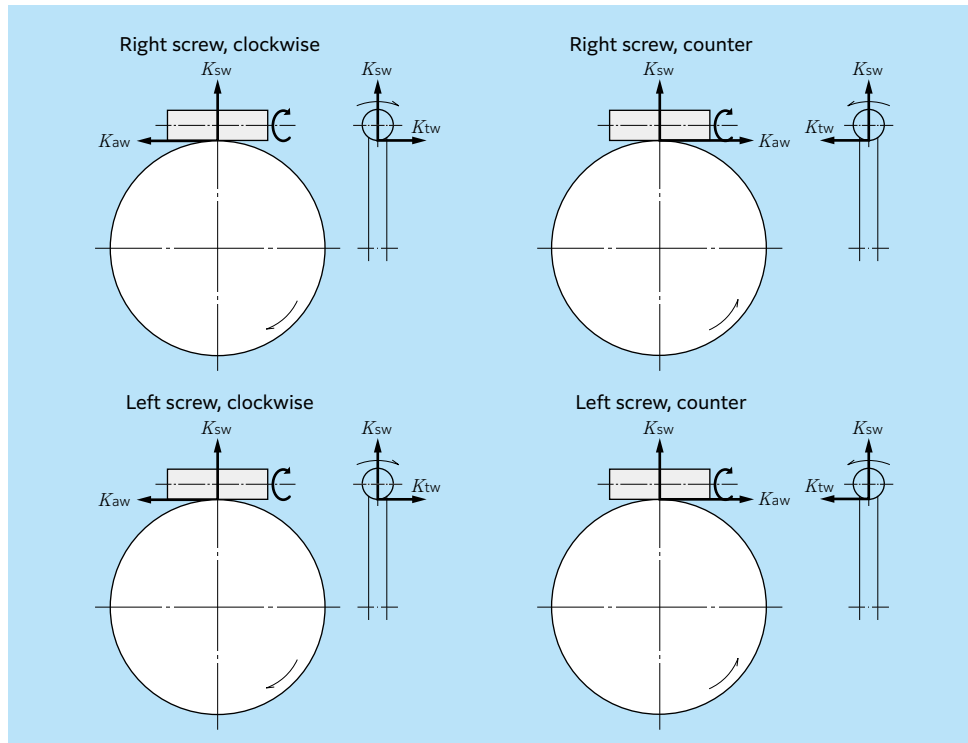

Fig. 4.8 Load acting on worm gears

Table 4.5 Calculation method of load acting on worm gears

Gear type	Worm shaft	Worm gear
Tangential load (tangential force) K_t	$K_{tw} = \frac{19.1 \times 10^6 H}{n D_{pw}}$	$K_{th} = \frac{K_{tw}}{\tan \gamma} = K_{aw}$
Radial load (separating force) K_s	$K_{sw} = \frac{K_{tw} \tan \alpha}{\tan \gamma}$	$K_{sh} = \frac{K_{tw} \tan \alpha}{\tan \gamma} = K_{sw}$
Parallel load on gear shaft (axial load) K_a	$K_{aw} = \frac{K_{tw}}{\tan \gamma}$	$K_{ah} = K_{tw}$

4.1.3 Chain / belt shaft load

The tangential loads on sprockets or pulleys when power (load) is transmitted by means of chains or belts can be calculated by formula (4.19) as shown in Fig. 4.9.

$$K_t = \frac{19.1 \times 10^6 \cdot H}{D_p \cdot n} \dots\dots\dots (4.19)$$

Where:

- K_t : Sprocket/pulley tangential load, N
- H : Transmitted power, kW
- D_p : Sprocket/pulley pitch diameter, mm

For belt drives, an initial tension is applied to give sufficient constant operating tension on the belt and pulley.

Taking this tension into account, the radial loads acting on the pulley are expressed by formula (4.20). For chain drives, the same formula can also be used if vibrations and shock loads are taken into consideration.

$$K_r = f_b \cdot K_t \dots\dots\dots (4.20)$$

Where:

- K_r : Sprocket or pulley radial load, N
- f_b : Chain or belt factor (Table 4.6)

Table 4.6 chain or belt factor f_b

Chain or belt type	f_b
Chain (single)	1.2 to 1.5
V-belt	1.5 to 2.0
Timing belt	1.1 to 1.3
Flat belt (w / tension pulley)	2.5 to 3.0
Flat belt	3.0 to 4.0

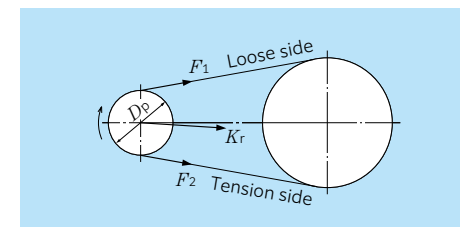

Fig. 4.9 Chain / belt loads

4.2 Bearing load distribution

For shafting, the static tension is considered to be supported by the bearings, and any loads acting on the shafts are distributed to the bearings. For example, in the gear shaft assembly depicted in Fig. 4.10, the applied bearing loads can be found by using formulas (4.21) and (4.22).

This example is a simple case, but in reality, many of the calculations are quite complicated.

$$F_{rA} = \frac{a+b}{b} F_I + \frac{d}{c+d} F_{II} \dots\dots\dots (4.21)$$

$$F_{rB} = -\frac{a}{b} F_I + \frac{c}{c+d} F_{II} \dots\dots\dots (4.22)$$

Where:

- F_{rA} : Radial load on bearing A, N
- F_{rB} : Radial load on bearing B, N
- F_I, F_{II} : Radial load on shaft, N

If directions of radial load differ, the vector sum of each respective load must be determined.

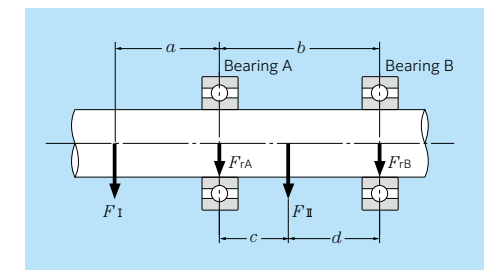

Fig. 4.10

4.3 Mean load

The load on bearings used in machines under normal circumstances will, in many cases, fluctuate according to a fixed time period or planned operation schedule. The load on bearings operating under such conditions can be converted to a mean load (F_m). This is a load which gives bearings the same life they would have under constant operating conditions.

(1) Fluctuating stepped load (Fig. 4.11)

The mean bearing load, F_m , for stepped loads is calculated from formula (4.23). $F_1, F_2 \dots F_n$ are the loads acting on the bearing; $n_1, n_2 \dots n_n$ and $t_1, t_2 \dots t_n$ are the bearing speeds and operating times respectively.

$$F_m = \left[\frac{\sum (F_i^p n_i t_i)}{\sum (n_i t_i)} \right]^{1/p} \dots \dots \dots (4.23)$$

Where:

- $p = 3$ For ball bearings
- $p = 10/3$ For roller bearings

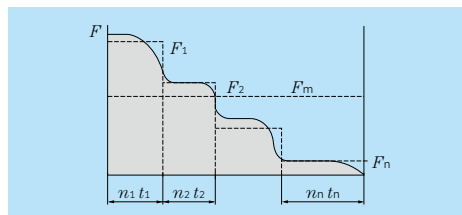

Fig. 4.11 Stepped load

(2) Continuously fluctuating load (Fig. 4.12)

Where it is possible to express the function $F(t)$ in terms of load cycle t_o and time t , the mean load is found by using formula (4.24).

$$F_m = \left[\frac{1}{t_o} \int_0^{t_o} F(t)^p dt \right]^{1/p} \dots \dots \dots (4.24)$$

Where:

- $p = 3$ For ball bearings
- $p = 10/3$ For roller bearings

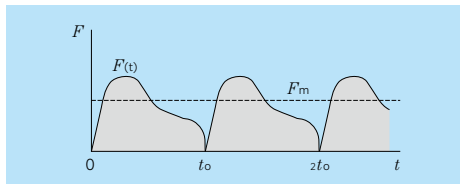

Fig. 4.12 Load that fluctuated as function of time

(3) Linear fluctuating load (Fig. 4.13)

The mean load, F_m , can be approximated by formula (4.25).

$$F_m = \frac{F_{min} + 2F_{max}}{3} \dots \dots \dots (4.25)$$

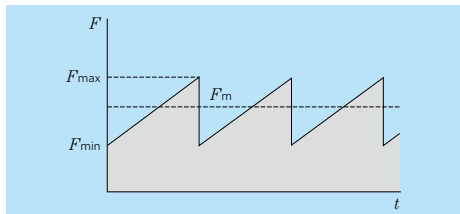

Fig. 4.13 Linear fluctuating load

(4) Sinusoidal fluctuating load (Fig. 4.14)

The mean load, F_m , can be approximated by formulas (4.26) and (4.27).

Case (a) $F_m = 0.75 F_{max} \dots \dots \dots (4.26)$

Case (b) $F_m = 0.65 F_{max} \dots \dots \dots (4.27)$

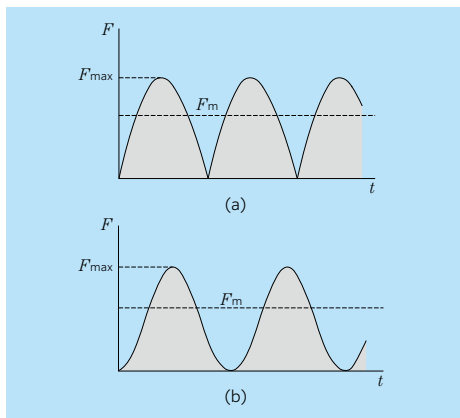

Fig. 4.14 Sinusoidal variable load

4.4 Equivalent load

4.4.1 Dynamic equivalent load

When both dynamic radial loads and dynamic axial loads act on a bearing at the same time, the hypothetical load acting on the center of the bearing which gives the bearings the same life as if they had only a radial load or only an axial load is called the dynamic equivalent load.

For radial bearings, this load is expressed as pure radial load and is called the dynamic equivalent radial load. For thrust bearings, it is expressed as pure axial load, and is called the dynamic equivalent axial load.

(1) Dynamic equivalent radial load

The dynamic equivalent radial load is expressed by formula (4.28).

$$P_r = XF_r + YF_a \dots \dots \dots (4.28)$$

Where:

- P_r : Dynamic equivalent radial load, N
- F_r : Actual radial load, N
- F_a : Actual axial load, N
- X : Radial load factor
- Y : Axial load factor

The values for X and Y are listed in the bearing tables.

(2) Dynamic equivalent axial load

As a rule, standard thrust bearings with α contact angle of 90° cannot carry radial loads. However, self-aligning thrust roller bearings can accept some radial load. The dynamic equivalent axial load for these bearings is given in formula (4.29).

$$P_a = F_a + 1.2F_r \dots \dots \dots (4.29)$$

Where:

- P_a : Dynamic equivalent axial load, N
- F_a : Actual axial load, N
- F_r : Actual radial load, N

Provided that $F_r / F_a \leq 0.55$ only.

4.4.2 Static equivalent load

The static equivalent load is a hypothetical

load which would cause the same total permanent deformation at the most heavily stressed contact point between the rolling elements and the raceway as under actual load conditions; that is when both static radial loads and static axial loads are simultaneously applied to the bearing.

For radial bearings this hypothetical load refers to pure radial loads, and for thrust bearings it refers to pure centric axial loads. These loads are designated static equivalent radial loads and static equivalent axial loads respectively.

(1) Static equivalent radial load

For radial bearings the static equivalent radial load can be found by using formula (4.30) or (4.31). The greater of the two resultant values is always taken for P_{0r} .

$$P_{0r} = X_0 F_r + Y_0 F_a \dots \dots \dots (4.30)$$

$$P_{0r} = F_r \dots \dots \dots (4.31)$$

Where:

- P_{0r} : Static equivalent radial load, N
- F_r : Actual radial load, N
- F_a : Actual axial load, N
- X_0 : Static radial load factor
- Y_0 : Static axial load factor

The values for X_0 and Y_0 are given in the respective bearing tables.

(2) Static equivalent axial load

For spherical thrust roller bearings the static equivalent axial load is expressed by formula (4.32).

$$P_{0a} = F_a + 2.7F_r \dots \dots \dots (4.32)$$

Where:

- P_{0a} : Static equivalent axial load, N
- F_a : Actual axial load, N
- F_r : Actual radial load, N

Provided that $F_r / F_a \leq 0.55$ only.

4.4.3 Load calculation for angular contact ball bearings and tapered roller bearings

For angular contact ball bearings and tapered roller bearings the pressure cone apex (load center) is

located as shown in Fig. 4.15, and their values are listed in the bearing tables.

When radial loads act on these types of bearings a component force is induced in the axial direction. For this reason, these bearings are used in pairs. For load calculation this component force must be taken into consideration and is expressed by formula (4.33).

$$F_a = \frac{0.5F_r}{Y} \dots\dots\dots (4.33)$$

Where:

- F_a : Axial component force, N
- F_r : Actual radial load, N
- Y : Axial load factor

The axial loads for these bearing pairs are given in Table 4.7.

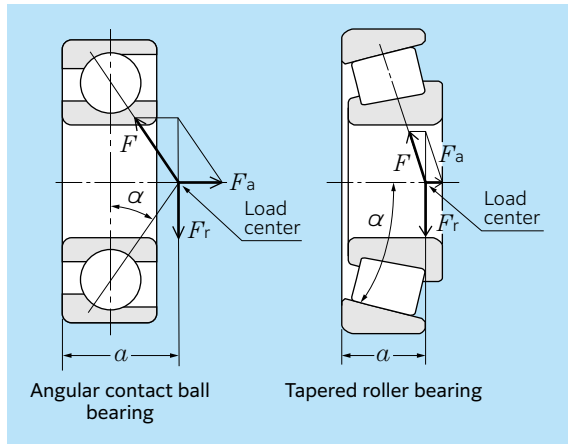

Fig. 4.15 Pressure cone apex and axial component force

Table 4.7 Bearing arrangement and equivalent load

Load center	Load conditions	Axial load
Rear	$\frac{0.5F_{r I}}{Y_I} \leq \frac{0.5F_{r II}}{Y_{II}} + F_a$	$F_{a I} = \frac{0.5F_{r II}}{Y_{II}} + F_a$
Front	$\frac{0.5F_{r I}}{Y_I} > \frac{0.5F_{r II}}{Y_{II}} + F_a$	$F_{a II} = \frac{0.5F_{r I}}{Y_I} - F_a$
Rear	$\frac{0.5F_{r II}}{Y_{II}} \leq \frac{0.5F_{r I}}{Y_I} + F_a$	$F_{a II} = \frac{0.5F_{r I}}{Y_I} + F_a$
Front	$\frac{0.5F_{r II}}{Y_{II}} > \frac{0.5F_{r I}}{Y_I} + F_a$	$F_{a I} = \frac{0.5F_{r II}}{Y_{II}} - F_a$

Note: 1. Applies when preload is zero.
 2. Radial forces in the opposite direction to the arrow in the above illustration are also regarded as positive.
 3. Dynamic equivalent radial load is calculated by using the table on the right of the size table of the bearing after axial load is obtained for X and Y factor.

4.5 Bearing rating life and load calculation examples

In the examples given in this section, for the purpose of calculation, all hypothetical load factors as well as all calculated load factors may be presumed to be included in the resultant load values.

Bearing loads and the basic rating life of bearings can be calculated using the bearing technical calculation tool on the NTN website (<https://www.ntnglobal.com>).

(Example 1)

What is the rating life in hours of operation L_{10h} for deep groove ball bearing **6208** operating at rotational speed $n = 650 \text{ min}^{-1}$, with a radial load F_r of 3.2 kN?

From formula (4.28) the dynamic equivalent radial load P_r :

$$P_r = F_r = 3.2 \text{ kN}$$

Basic dynamic load rating C_r for bearing **6208** given on page B-26 is 32.5 kN, ball bearing speed factor f_n relative to rotational speed $n = 650 \text{ min}^{-1}$ from Fig. 3.1 is $f_n = 0.37$. Thus life factor f_h from formula (3.5) is:

$$f_h = f_n \frac{C_r}{P_r} = 0.37 \times \frac{32.5}{3.2} = 3.76$$

Therefore, with $f_h = 3.76$ from Fig. 3.1 the rated life, L_{10h} , is approximately 27 000 hours.

(Example 2)

What is the life rating L_{10h} for the same bearing and conditions as in Example 1, but with an additional axial load F_a of 1.8 kN?

To find the dynamic equivalent radial load value for P_r , the radial load factor X, axial load factor Y, and Constant e are used.

Basic static load rating C_{0r} for bearing **6208**

given on page B-26 is 17.8 kN and f_0 is 14.0. Therefore:

$$\frac{f_0 \cdot F_a}{C_{0r}} = \frac{14 \times 1.8}{17.8} = 1.42$$

Calculated by the proportional interpolation method given on B-27, $e = 0.30$.

For the operating radial load and axial load:

$$\frac{F_a}{F_r} = \frac{1.8}{3.2} = 0.56 > e = 0.30$$

From B-27, $X = 0.56$ and $Y = 1.44$, and from formula (4.28) the dynamic equivalent radial load, P_r is:

$$P_r = XF_r + YF_a = 0.56 \times 3.2 + 1.43 \times 1.8 = 4.38 \text{ kN}$$

From Fig. 3.1 and Table 3.1 the life factor, f_h , is:

$$f_h = f_n \frac{C_r}{P_r} = 0.37 \times \frac{32.5}{4.38} = 2.75$$

Therefore, with life factor $f_h = 2.75$, from Fig. 3.1 the rated life, L_{10h} , is approximately 10,500 hours.

(Example 3)

Determine the optimum model number for a cylindrical roller bearing operating at the rotational speed $n = 450 \text{ min}^{-1}$, with a radial load F_r of 200 kN, and which must have a life (L_{10h}) of over 20 000 hours.

From Fig. 3.1 the life factor $f_h = 3.02$ (L_{10h} at 20 000), and the speed factor $f_n = 0.46$ ($n = 450 \text{ min}^{-1}$). To find the required basic dynamic load rating, C_r , formula (3.5) is used.

$$C_r = \frac{f_h}{f_n} P_r = \frac{3.02}{0.46} \times 200 = 1 313 \text{ kN}$$

From page B-108, the smallest bearing that fulfills all the requirements is **NU2332E** ($C_r = 1 460 \text{ kN}$).

(Example 4)

The spur gear shown in Fig. 4.16 (pitch diameter $D_p = 150$ mm, pressure angle $\alpha = 20^\circ$) is supported by a pair of tapered roller bearings, **32907XU** ($C_r = 30.5$ kN) and **32908XU** ($C_r = 36.0$ kN). Find rating life for each bearing when gear transfer power $H = 150$ kW and rotational speed $n = 2\,000$ min⁻¹.

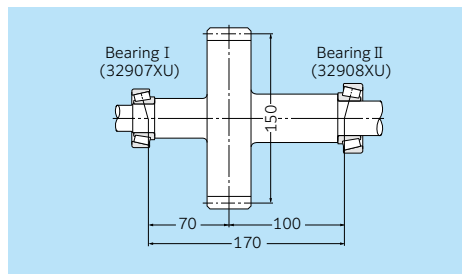

Fig. 4.16 Spur gear diagram

The gear load from formulas (4.3), (4.4a) and (4.5) is:

$$K_t = \frac{19.1 \times 10^6 \cdot H}{D_p \cdot n} = \frac{19\,100\,000 \times 150}{150 \times 2\,000} = 9.55 \text{ kN}$$

$$K_s = K_t \cdot \tan \alpha = 9.55 \times \tan 20^\circ = 3.48 \text{ kN}$$

$$K_r = \sqrt{K_t^2 + K_s^2} = \sqrt{9.55^2 + 3.48^2} = 10.16 \text{ kN}$$

The radial loads for bearings I and II are:

$$F_{rI} = \frac{100}{170} K_r = \frac{100}{170} \times 10.16 = 5.98 \text{ kN}$$

$$F_{rII} = \frac{70}{170} K_r = \frac{70}{170} \times 10.16 = 4.18 \text{ kN}$$

$$\frac{0.5F_{rI}}{Y_I} = 1.45 > \frac{0.5F_{rII}}{Y_{II}} = 1.01 \text{ Therefore,}$$

The axial loads for bearing I and II are:

$$F_{aI} = 0 \text{ kN}$$

$$F_{aII} = \frac{0.5F_{rI}}{Y_I} = \frac{0.5 \times 5.98}{2.06} = 1.45 \text{ kN}$$

From page B-137, the dynamic equivalent radial load for bearing I is:

$$\frac{F_{aI}}{F_{rI}} = \frac{0}{5.98} = 0 < e = 0.29$$

$$P_{rI} = F_{rI} = 5.98 \text{ kN}$$

Equally, the dynamic equivalent radial load for bearing II is:

$$\frac{F_{aII}}{F_{rII}} = \frac{1.45}{4.18} = 0.35 > e = 0.29$$

$$P_{rII} = XF_{rII} + Y_{II} F_{aII}$$

$$= 0.4 \times 4.18 + 2.07 \times 1.45 = 4.67 \text{ kN}$$

From formula (3.5) and Fig. 3.1 the life factor, f_h , for each bearing is

$$f_{hI} = f_n \frac{C_{rI}}{P_{rI}} = 0.293 \times 30.5 / 5.98 = 1.49$$

$$f_{hII} = f_n \frac{C_{rII}}{P_{rII}} = 0.293 \times 36.0 / 4.67 = 2.26$$

Therefore, from Table 3.1

$$L_{hI} = 500 f_{hI} = 1\,490 \text{ hours}$$

$$L_{hII} = 500 f_{hII} = 7\,550 \text{ hours}$$

The combined system bearing life, L_h , from formula (3.3) is:

$$L_h = \frac{1}{\left\{ \frac{1}{L_{hI}^e} + \frac{1}{L_{hII}^e} \right\}^{1/e}}$$

$$= \frac{1}{\left\{ \frac{1}{1\,900^{9/8}} + \frac{1}{7\,550^{9/8}} \right\}^{8/9}}$$

$$= 1\,600 \text{ hours}$$

(Example 5)

Find the mean load for spherical roller bearing **23932EMD1** ($C_r = 455$ kN) when operated under the fluctuating conditions shown in Table 4.8.

Table 4.8

Condition No. i	Operating time ϕ_i %	Radial load F_{ri} kN	Axial load F_{ai} kN	Rotational speed n_i min ⁻¹
1	5	10	2	1 200
2	10	12	4	1 000
3	60	20	6	800
4	15	25	7	600
5	10	30	10	400

The dynamic equivalent radial load, P_r , for each operating condition is found by using formula (4.28) and shown in Table 4.9. Because all the values for F_{ri} and F_{ai} from the bearing tables are greater than $F_a / F_r > e = 0.17$, $X = 0.67$, $Y_2 = 5.81$

$$P_{ri} = XF_{ri} + Y_2 F_{ai} = 0.67F_{ri} + 5.81F_{ai}$$

From formula (4.23) the mean load, F_m , is:

$$F_m = \left\{ \frac{\sum (P_{ri}^{10/3} \cdot n_i \cdot \phi_i)}{\sum (n_i \cdot \phi_i)} \right\}^{3/10} = 50.0 \text{ kN}$$

Table 4.9

Condition No. i	Dynamic equivalent radial load. P_{ri} (kN)
1	18.3
2	31.3
3	48.3
4	57.4
5	78.2

(Example 6)

Find the threshold values for rating life time and allowable axial load when cylindrical roller bearing **NUP312** is used under the following conditions:

Provided that intermittent axial load and oil lubricant.

$$\text{Radial load } F_r = 10 \text{ kN}$$

$$\text{Rotational speed } n = 2\,000 \text{ min}^{-1}$$

Radial load F_r is 10 kN, and

$$P_r = F_r = 10 \text{ kN}$$

The speed factor of cylindrical roller bearing, f_n , at $n = 2\,000$ min⁻¹, from Table 3.1

$$f_n = \left\{ \frac{33.3}{2\,000} \right\}^{3/10} = 0.293$$

The life factor, f_h , from Table 3.1

$$f_h = 0.293 \times \frac{137}{10} = 4.01$$

Therefore the basic rated life, L_{10h} , from

Table 3.1

$$L_{10h} = 500 \times 4.01^{10/3} \approx 51\,000 \text{ hours}$$

Next, the allowable axial load of the cylindrical roller bearing is shown on page A-32.

In formula (3.13) on page A-32, based on **NUP312** from Table 3.7 on page A-33, $k = 0.065$.

In addition, $D_{pw} = (60 + 130) / 2 = 95$ mm, $n = 2\,000$ min⁻¹.

Thus, the formula below holds when the case of the intermittent axial load is taken into consideration.

$$D_{pw} \cdot n \times 10^4 = 19 \times 10^4$$

In Fig. 3.16 on page A-33, $D_{pw} \cdot n = 19 \times 10^4$. In the case of the intermittent axial load, allowable surface pressure at the lip $P_t = 40$ MPa.

Therefore the allowable axial load, P_t , becomes the following.

$$P_t = 0.065 \times 60^2 \times 40 = 9\,360 \text{ N}$$

Based on Table 3.7 on page A-33, it is within the limits of $F_{a \max} < 0.4 \times 10\,000 = 4\,000$ N. Therefore $P_t < 4\,000$ N.

5. Boundary dimensions and bearing number codes

5.1 Boundary dimensions

A rolling bearing's major dimensions, known as "boundary dimensions," are shown in **Figs. 5.1 - 5.3**. To facilitate international bearing interchangeability and economical bearing production, bearing boundary dimensions have been standardized by the International Organization for Standardization (ISO). In Japan, rolling bearing boundary dimensions are regulated by Japanese Industrial Standards (JIS B 1512 series).

Boundary dimensions which have been standardized include: bearing bore diameter, outside diameter, width/height, and chamfer dimensions - all important dimensions when considering the compatibility of shafts, bearings, and housings. However, as a general rule, bearing internal construction dimensions are not covered by these standards.

For metric series rolling bearings there are 90 standardized bore diameters (d) ranging in size from 0.6 mm - 2,500 mm.

Outer diameter dimensions (D) for radial bearings with standardized bore diameter dimensions are covered in the "diameter series;" their corresponding width dimensions (B) are covered in the "width series." For thrust bearings there is no width series; instead, these dimensions are covered in the "height series." The combination of all these series is known as the "dimension series." All series numbers are shown in **Table 5.1**.

Although many rolling bearing dimensions are standardized and have been listed here for purposes of future standardization, there are many standard bearing dimensions which are not presently manufactured.

Boundary dimensions for radial bearings and thrust bearings are shown in the attached tables (I-2 to I-19).

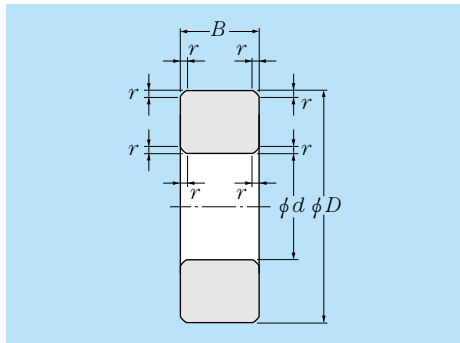

Fig. 5.1 Radial bearings (excluding tapered roller bearings)

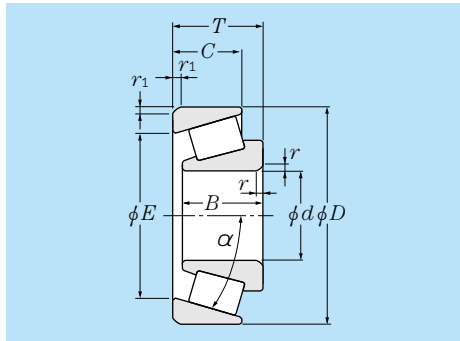

Fig. 5.2 Tapered roller bearings

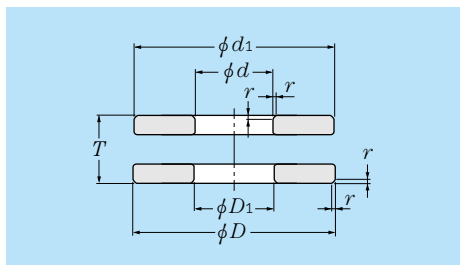

Fig. 5.3 Single direction thrust bearings

Table 5.1 Dimension series numbers

	Dimension series				Reference diagram
		Diameter series (outer diameter dimensions)	Width series (width dimensions)	Height series (height dimensions)	
Radial bearings (excluding tapered roller bearings)	Code	7.8.9.0.1.2.3.4	8.0.1.2.3.4.5.6	—	Fig. 5.4
	Dimension	Small ← → Large	Small ← → Large		
Tapered roller bearings	Code	9. 0. 1. 2. 3	0. 1. 2. 3	—	Fig. 5.5
	Dimension	Small ← → Large	Small ← → Large		
Thrust bearings	Code	0. 1. 2. 3. 4	—	7.9.1.2	Fig. 5.6
	Dimension	Small ← → Large		Small ← → Large	

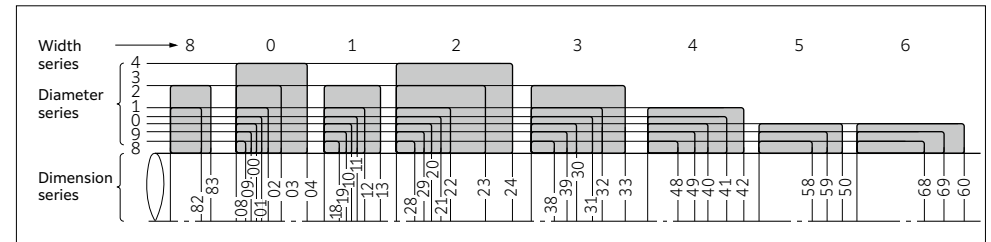

Fig. 5.4 Dimension series for radial bearings (excluding tapered roller bearings; diameter series 7 has been omitted)

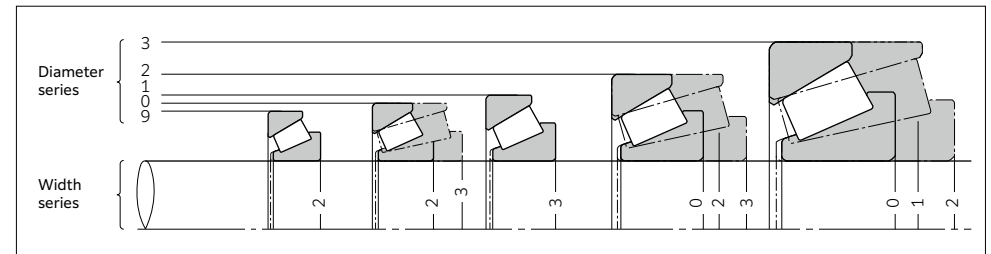

Fig. 5.5 Dimension series for tapered roller bearings (based on JIS B 1534)

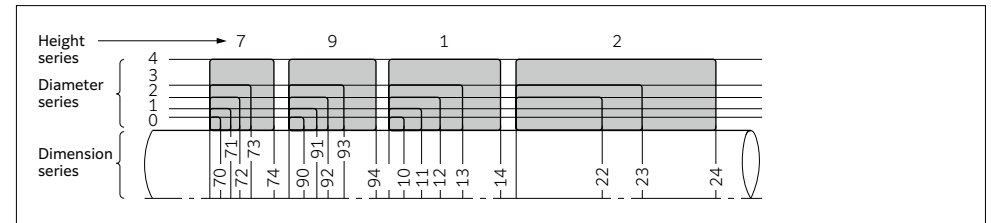

Fig. 5.6 Dimension series for thrust bearings (excluding diameter series 5)

5.2 Bearing numbers

Rolling bearing part numbers indicate **bearing type, dimensions, tolerances, internal construction**, and other related specifications. Bearing numbers are comprised of a “**basic number**” followed by “**supplementary codes**.” The makeup and order of bearing numbers is shown in **Table 5.2**.

The **basic number** indicates general information about a bearing, such as its fundamental type, boundary dimensions, series number, bore diameter code and contact angle. The **supplementary codes** derive from prefixes and suffixes which indicate a bearing’s tolerances, internal clearances, and related specifications.

(Bearing number examples)

6205ZZC3/2AS

- Grease: Alvania Grease S2
- Radial internal clearance C3
- Double side steel shield
- Nominal bore diameter 25 mm
- Diameter series 2
- Deep groove ball bearing**

23034EAD1

- Lubrication hole/lubrication groove
- ULTAGE basket-shaped pressed steel cage
- Nominal bore diameter 170 mm
- Diameter series 0
- Width series 3
- Self-aligning roller bearing**

7012BDB/GMP6

- Tolerances JIS Class 6
- Medium preload
- Back-to-back arrangement
- Contact angle 40°
- Nominal bore diameter 60 mm
- Diameter series 0
- Angular contact ball bearing**

240/750BK30

- Bore diameter : tapered inner ring bore, standard taper ratio 1:30
- Machined cage
- Nominal bore diameter 750 mm
- Diameter series 0
- Width series 4
- Self-aligning roller bearing**

NU320G1C3

- Radial internal clearance C3
- High strength machined brass rivetless cage with square holes
- Nominal bore diameter 100 mm
- Diameter series 3
- Cylindrical roller bearing NU type**

51120L1P5

- Tolerances JIS Class 5
- High strength, machined brass cage
- Nominal bore diameter 100 mm
- Diameter series 1
- Height series 1
- Thrust ball bearing**

4T-30208

- Nominal bore diameter 40mm
- Diameter series 2
- Width series 0
- Tapered roller bearing**
- Spec. 4T

“ULTAGE” (a name created from the combination of “ultimate,” signifying refinement, and “stage,” signifying **NTN’s** intention that this series of products be employed in diverse applications) is the general name for **NTN’s** new generation of bearings that are noted for their industry-leading performance.

Table 5.2 Bearing number composition and arrangement

Supplementary prefix code	Basic number						
	Bearing series			Bore diameter code		Contact angle code	
	Special application/ material/ heat treatment code	Bearing series code	Dimension series code				
Width/height series ¹⁾			Diameter series	Code	Bore diameter mm	Code ¹⁾	Contact angle
4T- 4T tapered roller bearings	Deep groove ball bearings (type code 6)			/0.6	0.6		Angular contact ball bearing
E- Bearings using case hardened steel	67 68 69	(1) (1) (1)	7 8 9	/1.5 /2.5	1.5 2.5	(A) (B) (C)	Standard contact angle 30° Standard contact angle 40° Standard contact angle 15°
F- Stainless steel bearings	60 62 63	(0) (0) (0)	0 2 3	1 :	1 :		Tapered roller bearing
TS2- Dimension stabilized bearing for high temperature use (to 160°C)	Angular contact ball bearings (type code 7)			00	10	(B)	Contact angle over 10° to/including 17°
TS3- Dimension stabilized bearing for high temperature use (to 200°C)	78 79 70 72 73	(1) (1) (1) (0) (0)	8 9 0 2 3	01 02 03	12 15 17	(C) (D)	Contact angle over 17° to/including 24° Contact angle over 24° to/including 32°
TS4- Dimension stabilized bearing for high temperature use (to 250°C)	Self aligning ball bearings (type code 1, 2)			/22	22		
	12 13	(0) (0)	2 3	/28 /32	28 32		
	Cylindrical roller bearings (type code NU, N, NF, NNU, NN, etc.)			04	20		
	NU10 NU22 NU3 NU23 NU4 NNU49 NNU30	1 (0) (0) (0) (0) 4 3	0 2 2 3 4 9 0	/500 /530 /560	500 530 560		
	Tapered roller bearings (type code 3)			05	25		
	329X 320X 302 322 303 303D 313X 323	2 2 0 2 0 0 1 2	9 0 2 2 3 3 3 3	/2 360 /2 500	2 360 2 500		
	Spherical roller bearings (type code 2)			06	30		
	239 230 240 231 241 222 232 213 223	3 3 4 3 4 2 3 1 2	9 0 0 1 1 2 2 3 3				
	Single direction thrust ball bearings (type code 5)			07	35		
	511 512 513 514	1 1 1 1	1 2 3 4				
	Cylindrical roller thrust bearings (type code 8)			08	40		
	811 812 893	1 1 9	1 2 3				
	Spherical thrust roller bearings (type code 2)			09	45		
	292 293 294	9 9 9	2 3 4				

¹⁾ Codes in () are not shown in nominal numbers.
Note: Please consult **NTN** Engineering concerning bearing series codes, and supplementary prefix/suffix codes not listed in the above table.

Supplementary suffix codes							
Internal modifications code	Cage code	Seal / Shield code	Raceway external configuration code	Duplex arrangement code	Internal clearance ¹⁾ Preload code	Tolerance code ¹⁾	Lubrication
U Internationally interchangeable tapered roller bearings	L1 High strength, machined brass cage	LB One-side synthetic rubber seal (non-contact type)	K Tapered inner ring bore, standard taper ratio 1:12	DB Back-to-back arrangement	C2 Internal clearance less than normal	(P0) JIS Class 0	/2AS Alvania Grease S2
R Non-internationally interchangeable tapered roller bearings	F1 Machined carbon steel cage	LLB Double-side synthetic rubber seal (non-contact type)	K30 Tapered inner ring bore, standard taper ratio 1:30	DF Face-to-face arrangement	(CN) Normal clearance	P6 JIS Class 6	/3AS Alvania Grease S3
ST Low torque tapered roller bearings	G1 High strength machined brass rivetless cage with square holes	LU One-side synthetic rubber seal (contact type)	N With snap ring groove	DT Tandem arrangement	C3 Internal clearance greater than normal	P5 JIS Class 5	/8A Alvania Grease EP2
HT Angular ball bearings and cylindrical roller bearings for high axial loads	G2 Pin type cage	LLU Double-side synthetic rubber seal (contact type)	NR Snap ring	D2 Two matched, paired bearings	C4 Internal clearance greater than C3	P4 JIS Class 4	/5K Multemp SRL
E High load capacity cylindrical roller bearing	T2 Molded resin cage	LH One-side synthetic rubber seal (low-torque type)	D With oil hole	+α Spacer (α = spacer's standard width dimensions)	C5 Internal clearance greater than C4	P2 JIS Class 2	/LX11 Barrierta JFE552
EA ULTAGE series cylindrical roller bearings	A Pressed steel cage (ULTAGE series self aligning roller bearings)	LLH Double-side synthetic rubber seal (low-torque type)	D1 Lubrication hole/lubrication groove	CM Radial internal clearance for electric motor use	-4 ABMA Class 4	-2 ABMA Class 2	/LP03 Solid grease
E ULTAGE series self aligning roller bearings	M High strength, machined brass cage (ULTAGE series self aligning roller bearings)	Z One-side steel Shield		/GN Normal preload	-3 ABMA Class 3	-0 ABMA Class 0	
UTG ULTAGE series Large tapered roller bearing	ZZ Double-side steel Shield			/GM Medium preload		/GH Heavy preload	

¹⁾ Codes in () are not shown in nominal numbers.
Note: Please consult **NTN** Engineering concerning bearing series codes, and supplementary prefix/suffix codes not listed in the above table.

5.2.1 Numbers of inch series tapered roller bearings

The composition of numbers of inch series tapered roller bearings is specified by the American Bearing Manufacturers Association (ABMA). The inner ring component (CONE) and the outer ring (CUP) each have a corresponding number. **Table 5.3** shows the composition of these numbers. Each corresponding code is also described in more detail below.

Table 5.3 Bearing number composition

Prefix code	Contact angle code	Series number	Serial number	Suffix code
XX	○	○○○	○○	XX

Note: X in the table is represented by letters, and ○ is represented by numbers.

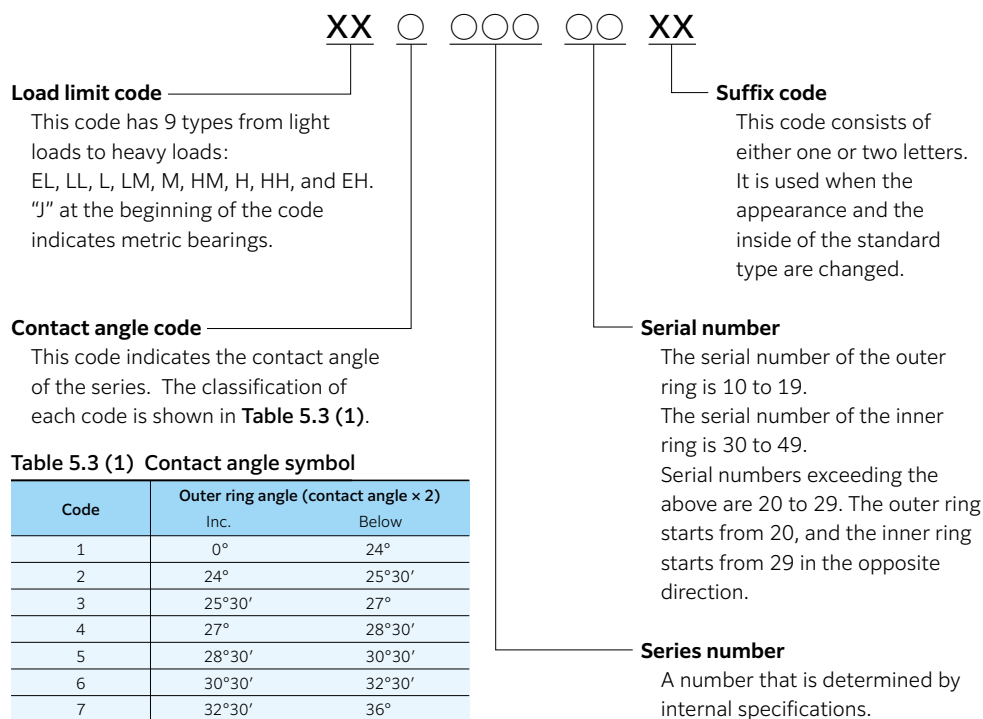

Table 5.3 (1) Contact angle symbol

Code	Outer ring angle (contact angle × 2)	
	Inc.	Below
1	0°	24°
2	24°	25°30'
3	25°30'	27°
4	27°	28°30'
5	28°30'	30°30'
6	30°30'	32°30'
7	32°30'	36°
8	36°	45°
9	45°(Excluding thrust bearings)	

5.2.2 Numbers of metric tapered roller bearings based on ISO355

Dimension series previously not covered by 3XX are regulated under JIS B 1512. These dimension series are specified in ISO355 and consist of series codes of the angle, diameter, and width. In addition, the inner ring subunit and the outer ring are internationally interchangeable. The composition of bearing

numbers are shown in **Table 5.4**. The series codes of the dimension series are shown in **Table 5.4 (1) to (3)**.

Table 5.4 Bearing number composition

Tapered roller bearing code	Dimension series			Bore diameter code
	Angle series	Diameter series	Width series	
T	○	X	X	○○○

Note: X in the table is represented by letters, and ○ is represented by numbers.

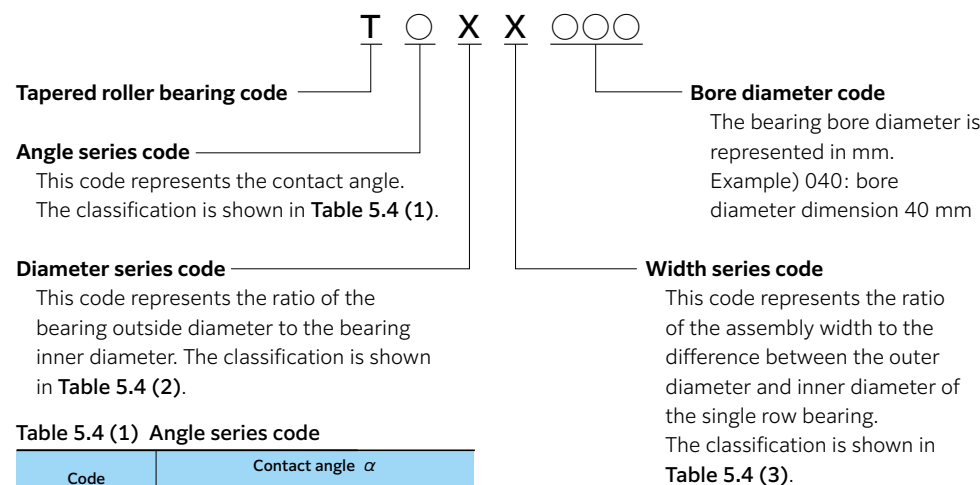

Table 5.4 (1) Angle series code

Code	Contact angle α	
	Over	Incl.
2	10°	13°52'
3	13°52'	15°59'
4	15°59'	18°55'
5	18°55'	23°
6	23°	27°
7	27°	30°

Table 5.4 (2) Diameter series code

Code	$\frac{D}{d^{0.77}}$	
	Over	Incl.
B	3.4	3.8
C	3.8	4.4
D	4.4	4.7
E	4.7	5
F	5	5.6
G	5.6	7

Note: Quantifiers
d: Nominal inner diameter
D: Nominal outside diameter

Table 5.4 (3) Width series code

Code	$\frac{T}{(D-d)^{0.95}}$	
	Over	Incl.
B	0.50	0.68
C	0.68	0.80
D	0.80	0.88
E	0.88	1

Note: Quantifiers
d: Nominal inner diameter
D: Nominal outside diameter
T: Assembly width of single row bearing

6. Bearing tolerances

6.1 Dimensional and rotational accuracy

Bearing “tolerances” or dimensional accuracy and running accuracy, are regulated by ISO and JIS standards, JIS B 1514 (rolling bearing tolerances) series. For **dimensional accuracy**, these standards prescribe the tolerances necessary when installing bearings on shafts or in housings. **Running accuracy** is defined as the allowable limits for bearing runout during operation.

Dimensional accuracy

Dimensional accuracy constitutes the acceptable values for bore diameter, outer diameter, assembled bearing width, and bore diameter uniformity as seen in chamfer dimensions, allowable inner ring tapered bore deviation and shape error. Also included are variation of mean bore diameter within a plane, outer diameter within a plane, mean outer diameter within a plane, as well as raceway thickness (for thrust bearings).

Running accuracy

Running accuracy constitutes the acceptable values for inner and outer ring radial runout and axial runout, inner ring side surface squareness, and outer ring outer diameter squareness.

Allowable rolling bearing tolerances have been established according to precision classes. Bearing precision is stipulated as JIS class 6, class 5, class 4, or class 2, with precision rising from ordinary precision indicated by class 0.

Table 6.1 indicates which standards and precision classes are applicable to the major bearing types. **Table 6.2** shows a relative comparison between JIS B 1514 precision class standards and other standards.

For details of allowable limitations and values, refer to **Tables 6.4 - 6.10**, which are described in the application table column of **Table 6.1**. Allowable values for chamfer dimensions are shown in **Table 6.11**. Allowable limitations and values for radial bearing inner ring tapered bores are shown in **Table 6.12**.

Table 6.1 Bearing types and applicable tolerance

Bearing type		Applicable standard	Accuracy class					Tolerance table
Deep groove ball bearings	JIS B 1514-1 (ISO492)	Class 0	Class 6	Class 5	Class 4	Class 2	Table 6.4	
Angular contact ball bearings		Class 0	Class 6	Class 5	Class 4	Class 2		
Self-aligning ball bearings		Class 0	—	—	—	—		
Cylindrical roller bearings		Class 0	Class 6	Class 5	Class 4	Class 2		
Needle roller bearings		Class 0	Class 6	Class 5	Class 4	—		
Self-aligning roller bearings		Class 0	—	—	—	—		
Tapered roller bearings	Metric series (single-row)	JIS B 1514	Class 0, 6X	Class 6 ¹⁾	Class 5	Class 4	—	Table 6.5
	Metric series (double-row/four-row)	BAS1002	Class 0	—	—	—	—	Table 6.6
	Inch series	ANSI/ABMA Std.19	Class 4	Class 2	Class 3	Class 0	Class 00	Table 6.7
	J series	ANSI/ABMA Std.19.1	Class K	Class N	Class C	Class B	Class A	Table 6.8
Thrust ball bearings	JIS B 1514-2 (ISO199)	Class 0	Class 6	Class 5	Class 4	—	Table 6.9	
Spherical roller thrust bearings		Class 0	—	—	—	—	Table 6.10	

1) The class is the NTN standard class.

Table 6.2 Comparison of tolerance classifications of national standards

Standard	Applicable standard	Accuracy class					Bearing type
Japanese industrial standard (JIS)	JIS B 1514-1	Class 0, 6	Class 6	Class 5	Class 4	Class 2	Radial bearings
	JIS B 1514-2	Class 0	Class 6	Class 5	Class 4	—	Thrust bearings
International Organization for Standardization (ISO)	ISO 492	Normal class Class 6X	Class 6	Class 5	Class 4	Class 2	Radial bearings
	ISO 199	Normal Class	Class 6	Class 5	Class 4	—	Thrust bearings
	ISO 578	Class 4	—	Class 3	Class 0	Class 00	Tapered roller bearings (Inch series)
	ISO 1224	—	—	Class 5A	Class 4A	—	Precision instrument bearings
Deutsches Institut für Normung (DIN)	DIN 620	P0	P6	P5	P4	P2	All types
American National Standards Institute (ANSI) American Bearing Manufacturer's Association (ABMA)	ANSI/ABMA Std.20 ¹⁾	ABEC-1 RBEC-1	ABEC-3 RBEC-3	ABEC-5 RBEC-5	ABEC-7	ABEC-9	Radial bearings (excluding tapered roller bearings)
	ANSI/ABMA Std.19.1	Class K	Class N	Class C	Class B	Class A	Tapered roller bearings (Metric series)
	ANSI/ABMA Std.19	Class 4	Class 2	Class 3	Class 0	Class 00	Tapered roller bearings (Inch series)

1) "ABEC" is applied to ball bearings and "RBEC" to roller bearings.

Note: 1. JIS B 1514 series, ISO492, 199, and DIN620 have the same specification level.

2. The tolerance and allowance of JIS B 1514 series are slightly different from those of ABMA standards.

Application of accuracy class

Ordinary precision JIS Class 0 is applied to general roller bearings. However, depending on the conditions and applications, bearings with JIS Class 5 or higher may be necessary.

Table 6.3 shows application examples of accuracy class according to the required performance of bearings to be used.

Table 6.3 Application example of accuracy class

Required performance	Application example	Applied accuracy class
Accuracy under high speed	Machine tool main spindles Printing machine body bearings Magnetic tape guides	JIS Class 5, JIS Class 4 or higher JIS Class 5 JIS Class 5
	Jet engine main spindles Turbochargers Machine tool main spindles Touchdown bearings of magnetic bearing spindles for turbo-molecular pumps	JIS Class 4 or higher Equivalent to JIS Class 4 JIS Class 5, JIS Class 4 or higher JIS Class 5
Low torque low noise	Machine tool main spindles Hubs of road bikes Cleaner motors Hand spinners Fan motors	JIS Class 5, JIS Class 4 or higher JIS Class 5 JIS Class 0 JIS Class 0 JIS Class 0

6.2 JIS terms

The following is a description of JIS accuracy terms used in Table 6.4.

(However, the outer diameter surface is omitted because the meaning is similar.)

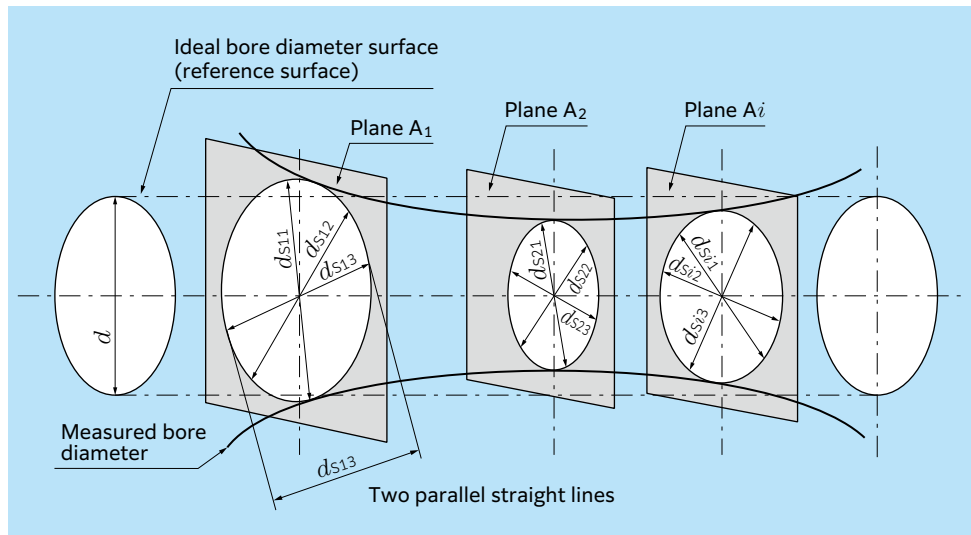

Fig. 6.1 Shape model figure

Terms	Quantifiers	Description
Nominal bore diameter	d	Reference dimension representing the bore diameter size, and reference value with respect to the dimensional difference of the actual bore diameter surface.
Single bore diameter	d_s	Distance between two parallel straight lines that are in contact with the intersection line of the actual bearing bore diameter surface and the radial plane.
Deviation of a single bore diameter	Δd_s	Difference between d_s and d (difference of nominal diameter serving as the measured bore and standard).
Mean bore diameter in a single plane	d_{mp}	Arithmetic mean of the maximum and minimum measured bore diameters within one radial plane. In the model figure, in arbitrary radial plane A_i , when the maximum bore diameter is d_{si1} and the minimum bore diameter is d_{si3} , the value is obtained by $(d_{si1} + d_{si3})/2$. There is one value for each plane.
Mean bore diameter	d_m	Arithmetic mean of the maximum and minimum measured bore diameters obtained from all the cylindrical surfaces. In the model figure, when the maximum measured bore diameter is d_{s11} and the minimum measured bore diameter is d_{s23} , which are obtained from the all the planes A_1, A_2, \dots, A_i , the mean bore diameter is obtained by $(d_{s11} + d_{s23})/2$. There is one value for one cylindrical surface.
Deviation of mean bore diameter	Δd_m	Difference between the mean bore diameter and the nominal bore diameter.
Deviation of mean bore diameter in a single plane	Δd_{mp}	Difference between the arithmetic mean and the nominal bore diameter of the maximum and minimum measured bore diameters within one radial plane. The value is specified in JIS.
Variation of bore diameter in a single plane	V_{dsp}	Difference between the maximum and minimum measured bore diameters within one radial plane. In the model figure, in radial plane A_1 , when the maximum measured bore diameter is d_{s11} and the minimum measured bore diameter is d_{s13} , the difference is V_{dsp} and one value can be obtained for one plane. This characteristic is an index that indicates the roundness. The value is specified in JIS.
Variation of mean bore diameter	V_{dmp}	Difference between the maximum and minimum values of the mean bore diameter within a plane that are obtained from all the planes. A unique value is obtained for each product, and it is near to cylindricity (that is different from geometric cylindricity). The value is specified in JIS.
Nominal inner ring width	B	Distance between both theoretical side surfaces of a raceway. This value is a reference dimension that represents the raceway surface (distance between both side surfaces).
Single inner ring width	B_s	Distance between two intersections. The straight is perpendicular to the plane that is in contact with the inner ring reference side and both actual side surfaces. This value represents the actual width dimension of an inner ring.
Deviation of a single inner ring width	ΔB_s	Difference between the measured inner ring width and the nominal inner ring width. This value is also the difference between the measured inner ring width dimension and the reference dimension that represents the inner ring width. The value is specified in JIS.
Variation of inner ring width	V_{Bs}	Difference between the maximum and minimum measured inner ring widths, which are specified in JIS.
Radial runout of inner ring of assembled bearing	K_{ia}	Difference between the maximum and minimum values of the radial distance between the inner ring bore diameter at each angle position and one fixed point of the outer ring outer diameter surface with respect to radial runout.
Axial runout of inner ring of assembled bearing	S_{ia}	Difference between the maximum and minimum values of the axial distance between the inner ring reference side surface at each angle position and one fixed point of the outer ring outer diameter surface with respect to half the radial distance of the raceway contact diameter from the inner ring central axis and the inner ring of a deep groove ball bearing.

Table 6.4 Tolerance of radial bearings (except tapered roller bearings)

Table 6.4 (1) Inner rings

Table with 11 columns: Nominal bore diameter (d), Deviation of mean bore diameter in a single plane (Δdmp), and Variation of bore diameter in a single plane (Vdsp). Rows show diameter series 9, 10, 11, 12, 13, 14, 15, 16, 17, 18, 19, 20, 21, 22, 23, 24, 25, 26, 27, 28, 29, 30, 31, 32, 33, 34, 35, 36, 37, 38, 39, 40, 41, 42, 43, 44, 45, 46, 47, 48, 49, 50, 51, 52, 53, 54, 55, 56, 57, 58, 59, 60, 61, 62, 63, 64, 65, 66, 67, 68, 69, 70, 71, 72, 73, 74, 75, 76, 77, 78, 79, 80, 81, 82, 83, 84, 85, 86, 87, 88, 89, 90, 91, 92, 93, 94, 95, 96, 97, 98, 99, 100.

1) The dimensional difference Δd1s of the measured bore diameter applied to Classes 4 and 2 is the same as the tolerance of dimensional difference Δdmp of the mean bore diameter within a plane. However, the dimensional difference is applied to diameter series 0, 1, 2, 3 and 4 for Class 4, and also to all the diameter series for Class 2.

Table with 11 columns: Variation of mean bore diameter (Vdmp), Radial runout of inner ring of assembled bearing (Kia), Perpendicularity of inner ring face with respect to the bore (Sd), Axial runout of inner ring of assembled bearing (S1a2), Deviation of a single inner ring width (ΔBs), and Variation of inner ring width (VBS). Rows show diameter series 9, 10, 11, 12, 13, 14, 15, 16, 17, 18, 19, 20, 21, 22, 23, 24, 25, 26, 27, 28, 29, 30, 31, 32, 33, 34, 35, 36, 37, 38, 39, 40, 41, 42, 43, 44, 45, 46, 47, 48, 49, 50, 51, 52, 53, 54, 55, 56, 57, 58, 59, 60, 61, 62, 63, 64, 65, 66, 67, 68, 69, 70, 71, 72, 73, 74, 75, 76, 77, 78, 79, 80, 81, 82, 83, 84, 85, 86, 87, 88, 89, 90, 91, 92, 93, 94, 95, 96, 97, 98, 99, 100.

2) Applies to ball bearings such as deep groove ball bearings and angular ball bearings. 3) Applies to individual raceway rings manufactured for combined bearing use. 4) The nominal bore diameter of bearings of 0.6 mm is included in this dimensional division.

Table 6.4 (2) Outer rings

Table with 11 columns: Nominal outside diameter (D), Deviation of mean outside diameter in a single plane (ΔDmp), and Variation of outside diameter in a single plane (VDsp). Rows show diameter series 9, 10, 11, 12, 13, 14, 15, 16, 17, 18, 19, 20, 21, 22, 23, 24, 25, 26, 27, 28, 29, 30, 31, 32, 33, 34, 35, 36, 37, 38, 39, 40, 41, 42, 43, 44, 45, 46, 47, 48, 49, 50, 51, 52, 53, 54, 55, 56, 57, 58, 59, 60, 61, 62, 63, 64, 65, 66, 67, 68, 69, 70, 71, 72, 73, 74, 75, 76, 77, 78, 79, 80, 81, 82, 83, 84, 85, 86, 87, 88, 89, 90, 91, 92, 93, 94, 95, 96, 97, 98, 99, 100.

5) The dimensional difference ΔD1s of the measured outer diameter applied to Classes 4 and 2 is the same as the tolerance of dimensional difference ΔDmp of the mean outer diameter within a plane. However, the dimensional difference is applied to diameter series 0, 1, 2, 3 and 4 for Class 4, and also to all the diameter series for Class 2.

Table with 11 columns: Variation of outside diameter in a single plane (VDsp6), Variation of mean outside diameter (Vdmp), Radial runout of outer ring of assembled bearing (Kea), Perpendicularity of outer ring outside surface with respect to the face (Sb), Axial runout of outer ring of assembled bearing (Sea7), Deviation of a single outer ring width (ΔCs), and Variation of outer ring width (VCs). Rows show diameter series 9, 10, 11, 12, 13, 14, 15, 16, 17, 18, 19, 20, 21, 22, 23, 24, 25, 26, 27, 28, 29, 30, 31, 32, 33, 34, 35, 36, 37, 38, 39, 40, 41, 42, 43, 44, 45, 46, 47, 48, 49, 50, 51, 52, 53, 54, 55, 56, 57, 58, 59, 60, 61, 62, 63, 64, 65, 66, 67, 68, 69, 70, 71, 72, 73, 74, 75, 76, 77, 78, 79, 80, 81, 82, 83, 84, 85, 86, 87, 88, 89, 90, 91, 92, 93, 94, 95, 96, 97, 98, 99, 100.

6) Applies to cases where snap rings are not installed on the bearings. 7) Applies to ball bearings such as deep groove ball bearings and angular ball bearings. 8) The nominal bore diameter of bearings of 2.5 mm is included in this dimensional division.

Table 6.5 Tolerance of tapered roller bearings (metric series)

Table 6.5 (1) Inner rings

Nominal bore diameter d		Deviation of mean bore diameter in a single plane Δd_{mp}				Variation of bore diameter in a single plane V_{dsp}				Variation of mean bore diameter V_{dmp}				Radial runout of inner ring of assembled bearing K_{ia}				Perpendicularity of inner ring face with respect to the bore S_d						
mm		Class 0		Class 6 ¹⁾		Class 5		Class 4 ²⁾		Class 0		Class 6 ¹⁾		Class 5		Class 4		Class 0		Class 5		Class 4		
Over	Incl.	Upper	Lower	Upper	Lower	Upper	Lower	Upper	Lower	Upper	Lower	Upper	Lower	Upper	Lower	Upper	Lower	Upper	Upper	Lower	Upper	Lower	Upper	Lower
		Max.				Max.				Max.				Max.				Max.						
10	18	0	-12	0	-7	0	-5	12	7	5	4	9	5	5	4	15	7	5	3	7	3			
18	30	0	-12	0	-8	0	-6	12	8	6	5	9	6	5	4	18	8	5	3	8	4			
30	50	0	-12	0	-10	0	-8	12	10	8	6	9	8	5	5	20	10	6	4	8	4			
50	80	0	-15	0	-12	0	-9	15	12	9	7	11	9	6	5	25	10	7	4	8	5			
80	120	0	-20	0	-15	0	-10	20	15	11	8	15	11	8	5	30	13	8	5	9	5			
120	180	0	-25	0	-18	0	-13	25	18	14	10	19	14	9	7	35	18	11	6	10	6			
180	250	0	-30	0	-22	0	-15	30	22	17	11	23	16	11	8	50	20	13	8	11	7			
250	315	0	-35	—	—	—	—	35	—	—	—	26	—	—	—	60	—	—	—	—	—			
315	400	0	-40	—	—	—	—	40	—	—	—	30	—	—	—	70	—	—	—	—	—			

1) Class 6 is the NTN standard class.

2) The dimensional difference Δd_s of the measured bore diameter applied to Class 4 is the same as the tolerance of dimensional difference Δd_{mp} of the mean bore diameter within a plane.

Table 6.5 (2) Outer rings

Nominal outside diameter D		Deviation of mean outside diameter in a single plane ΔD_{mp}				Variation of outside diameter in a single plane V_{Dsp}				Variation of mean outside diameter V_{Dmp}				Radial runout of outer ring of assembled bearing K_{ea}				Perpendicularity of outer ring outside surface with respect to the face S_D ³⁾						
mm		Class 0		Class 6 ¹⁾		Class 5		Class 4 ²⁾		Class 0		Class 6 ¹⁾		Class 5		Class 4		Class 0		Class 5		Class 4		
Over	Incl.	Upper	Lower	Upper	Lower	Upper	Lower	Upper	Lower	Upper	Lower	Upper	Lower	Upper	Lower	Upper	Lower	Upper	Upper	Lower	Upper	Lower	Upper	Lower
		Max.				Max.				Max.				Max.				Max.						
18	30	0	-12	0	-8	0	-6	12	8	6	5	9	6	5	4	18	9	6	4	8	4			
30	50	0	-14	0	-9	0	-7	14	9	7	5	11	7	5	5	20	10	7	5	8	4			
50	80	0	-16	0	-11	0	-9	16	11	8	7	12	8	6	5	25	13	8	5	8	4			
80	120	0	-18	0	-13	0	-10	18	13	10	8	14	10	7	5	35	18	10	6	9	5			
120	150	0	-20	0	-15	0	-11	20	15	11	8	15	11	8	6	40	20	11	7	10	5			
150	180	0	-25	0	-18	0	-13	25	18	14	10	19	14	9	7	45	23	13	8	10	5			
180	250	0	-30	0	-20	0	-15	30	20	15	11	23	15	10	8	50	25	15	10	11	7			
250	315	0	-35	0	-25	0	-18	35	25	19	14	26	19	13	9	60	30	18	11	13	8			
315	400	0	-40	0	-28	0	-20	40	28	22	15	30	21	14	10	70	35	20	13	13	10			
400	500	0	-45	—	—	—	—	45	—	—	—	34	—	—	—	80	—	—	—	—	—			
500	630	0	-50	—	—	—	—	60	—	—	—	38	—	—	—	100	—	—	—	—	—			

3) Does not apply to bearings with flange.

4) The dimensional difference ΔD_s of the measured outer diameter applied to Class 4 is the same as the tolerance of dimensional difference ΔD_{mp} of the mean outer diameter within a plane.

Unit: μm

Axial runout of inner ring of assembled bearing S_{ia}	Deviation of a single inner ring width ΔB_s				Deviation of the actual assembled bearing width ΔT_s							
	Class 0		Class 5		Class 0		Class 5					
	Class 6	Class 6 ¹⁾	Class 6 ¹⁾	Class 4	Class 6	Class 6 ¹⁾	Class 6 ¹⁾	Class 4				
Class 4	Upper	Lower	Upper	Lower	Upper	Lower	Upper	Lower	Upper	Lower	Upper	Lower
Max.												
3	0	-120	0	-50	0	-200	+200	0	+100	0	+200	-200
4	0	-120	0	-50	0	-200	+200	0	+100	0	+200	-200
4	0	-120	0	-50	0	-240	+200	0	+100	0	+200	-200
4	0	-150	0	-50	0	-300	+200	0	+100	0	+200	-200
5	0	-200	0	-50	0	-400	+200	-200	+100	0	+200	-200
7	0	-250	0	-50	0	-500	+350	-250	+150	0	+350	-250
8	0	-300	0	-50	0	-600	+350	-250	+150	0	+350	-250
—	0	-350	0	-50	—	—	+350	-250	+200	0	—	—
—	0	-400	0	-50	—	—	+400	-400	+200	0	—	—

Table 6.5 (3) Effective width of inner subunits and outer rings

Unit: μm

Axial runout of outer ring of assembled bearing S_{ea}	Deviation of a single outer ring width ΔC_s			
	Class 0, Class 6 ¹⁾		Class 5, Class 4	
	Class 4	Class 4	Class 6 ¹⁾	Class 6 ¹⁾
Class 4	Upper	Lower	Upper	Lower
Max.				
5			0	-100
5			0	-100
5			0	-100
6			0	-100
7			0	-100
8			0	-100
10			0	-100
10			0	-100
13			0	-100
—			0	-100
—			0	-100

5) Applies to bearings with a nominal bore diameter d over 10 mm and 400 mm or less.

Nominal bore diameter d		Deviation of the actual effective width of inner subunit assembled with a master outer ring ΔT_{1s}				Deviation of the actual effective width of outer ring assembled with a master inner subunit ΔT_{2s}			
mm		Class 0		Class 6 ¹⁾		Class 0		Class 6 ¹⁾	
Over	Incl.	Upper	Lower	Upper	Lower	Upper	Lower	Upper	Lower
10	18	+100	0	+50	0	+100	0	+50	0
18	30	+100	0	+50	0	+100	0	+50	0
30	50	+100	0	+50	0	+100	0	+50	0
50	80	+100	0	+50	0	+100	0	+50	0
80	120	+100	-100	+50	0	+100	-100	+50	0
120	180	+150	-150	+50	0	+200	-100	+100	0
180	250	+150	-150	+50	0	+200	-100	+100	0
250	315	+150	-150	+100	0	+200	-100	+100	0
315	400	+200	-200	+100	0	+200	-200	+100	0

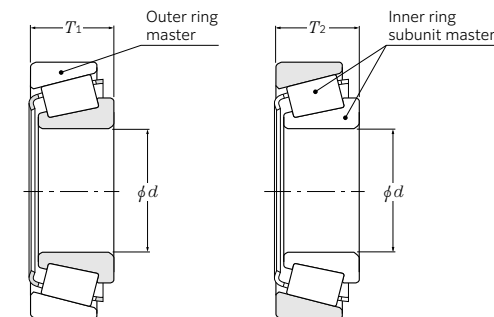

Table 6.6 Tolerance of tapered roller bearings (inch series)

Table 6.6 (1) Inner rings

Unit: μm

Nominal bore diameter		Deviation of a single bore diameter									
d		Δd_s									
mm (inch)		Class 4		Class 2		Class 3		Class 0		Class 00	
Over	Incl.	Upper	Lower	Upper	Lower	Upper	Lower	Upper	Lower	Upper	Lower
—	—	+13	0	+13	0	+13	0	+13	0	+8	0
76.2 (3)	266.7 (10.5)	+25	0	+25	0	+13	0	+13	0	+8	0
266.7 (10.5)	304.8 (12)	+25	0	+25	0	+13	0	+13	0	—	—
304.8 (12)	609.6 (24)	+51	0	+51	0	+25	0	—	—	—	—
609.6 (24)	914.4 (36)	+76	0	—	—	+38	0	—	—	—	—
914.4 (36)	1 219.2 (48)	+102	0	—	—	+51	0	—	—	—	—
1 219.2 (48)	—	+127	0	—	—	+76	0	—	—	—	—

Table 6.6 (2) Outer rings

Unit: μm

Nominal outside diameter		Deviation of a single outside diameter									
D		ΔD_s									
mm (inch)		Class 4		Class 2		Class 3		Class 0		Class 00	
Over	Incl.	Upper	Lower	Upper	Lower	Upper	Lower	Upper	Lower	Upper	Lower
—	—	+25	0	+25	0	+13	0	+13	0	+8	0
266.7 (10.5)	304.8 (12)	+25	0	+25	0	+13	0	+13	0	—	—
304.8 (12)	609.6 (24)	+51	0	+51	0	+25	0	—	—	—	—
609.6 (24)	914.4 (36)	+76	0	+76	0	+38	0	—	—	—	—
914.4 (36)	1 219.2 (48)	+102	0	—	—	+51	0	—	—	—	—
1 219.2 (48)	—	+127	0	—	—	+76	0	—	—	—	—

Table 6.6 (3) Assembly width of single-row bearings, combination width of 4-row bearings, effective width of inner ring subunits, effective width of outer rings

Nominal bore diameter		Nominal outside diameter		Deviation of the actual assembled single row bearing width						Deviation of four-row bearing overall width			
d		D		ΔT_s						$\Delta B_{2s}, \Delta C_{2s}$ Class 4,2,3,0			
mm (inch)		mm (inch)		Class 4		Class 2		Class 3		Class 0,00		Upper	Lower
Over	Incl.	Over	Incl.	Upper	Lower	Upper	Lower	Upper	Lower	Upper	Lower	Upper	Lower
—	101.6 (4)	—	—	+203	0	+203	0	+203	-203	+203	-203	+1 524	-1 524
101.6 (4)	304.8 (12)	—	508.0 (20)	+356	-254	+203	0	+203	-203	+203	-203	+1 524	-1 524
304.8 (12)	609.6 (24)	—	508.0 (20)	+381	-381	+381	-381	+203	-203	—	—	+1 524	-1 524
304.8 (12)	609.6 (24)	508.0 (20)	—	+381	-381	+381	-381	+381	-381	—	—	+1 524	-1 524
609.6 (24)	—	—	—	+381	-381	—	—	+381	-381	—	—	+1 524	-1 524

Table 6.6 (4) Radial runout of inner and outer rings

Unit: μm

Nominal outside diameter		Radial runout of inner ring of assembled bearing				
D		K_{ia}				
mm (inch)		Radial runout of outer ring of assembled bearing				
		K_{ea}				
		Class 4	Class 2	Class 3	Class 0	Class 00
		Max.	Max.	Max.	Max.	Max.
—	304.8 (14)	51	38	8	4	2
304.8 (14)	609.6 (24)	51	38	18	—	—
609.6 (24)	914.4 (36)	76	51	51	—	—
914.4 (36)	—	76	—	76	—	—

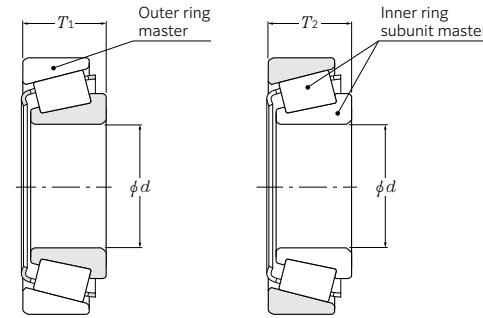

Deviation of the actual effective width of inner subunit assembled with a master outer ring						Deviation of the actual effective width of outer ring assembled with a master inner subunit					
ΔT_{1s}						ΔT_{2s}					
Class 4		Class 2		Class 3		Class 4		Class 2		Class 3	
Upper	Lower	Upper	Lower	Upper	Lower	Upper	Lower	Upper	Lower	Upper	Lower
+102	0	+102	0	+102	-102	+102	0	+102	0	+102	-102
+152	-152	+102	0	+102	-102	+203	-102	+102	0	+102	-102
—	—	+178	-178 ¹⁾	+102	-102 ¹⁾	—	—	+203	-203 ¹⁾	+102	-102 ¹⁾
—	—	—	—	—	—	—	—	—	—	—	—
—	—	—	—	—	—	—	—	—	—	—	—

1) Applies to nominal bore diameters d of 406.400 mm (16 inch) or less.

Table 6.7 Tolerance of double-row and 4-row tapered roller bearings (metric series)

Table 6.7 (1) Inner rings

Unit: μm

Nominal bore diameter d mm		Deviation of mean bore diameter in a single plane Δd_{mp}		Variation of bore diameter in a single plane V_{dsp}	Variation of mean bore diameter V_{dmp}	Radial runout of inner ring of assembled bearing K_{ia}	Deviation of a single inner ring of width ΔB_s		Deviation of bearing overall width			
									Double row bearing ΔB_{1s}		Four-row bearing ΔB_{2s}	
Over	Incl.	Upper	Lower	Max.	Max.	Max.	Upper	Lower	Upper	Lower	Upper	Lower
30	50	0	-12	12	9	20	0	-120	+240	-240	—	—
50	80	0	-15	15	11	25	0	-150	+300	-300	—	—
80	120	0	-20	20	15	30	0	-200	+400	-400	+500	-500
120	180	0	-25	25	19	35	0	-250	+500	-500	+600	-600
180	250	0	-30	30	23	50	0	-300	+600	-600	+750	-750
250	315	0	-35	35	26	60	0	-350	+700	-700	+900	-900
315	400	0	-40	40	30	70	0	-400	+800	-800	+1 000	-1 000
400	500	0	-45	45	34	80	0	-450	+900	-900	+1 200	-1 200
500	630	0	-60	60	40	90	0	-500	+1 000	-1 000	+1 200	-1 200
630	800	0	-75	75	45	100	0	-750	+1 500	-1 500	+1 500	-1 500
800	1 000	0	-100	100	55	115	0	-1 000	+1 500	-1 500	+1 500	-1 500

1) Values in dot-line frame are the NTN standard.

Table 6.7 (2) Outer rings

Unit: μm

Nominal outside diameter D mm		Deviation of mean outside diameter in a single plane ΔD_{mp}		Variation of outside diameter in a single plane V_{Dsp}	Variation of mean outside diameter V_{Dmp}	Radial runout of outer ring of assembled bearing K_{ea}	Deviation of a single outer ring width ΔC_s		Deviation of bearing overall width			
									Double row bearing ΔC_{1s}		Four-row bearing ΔC_{2s}	
Over	Incl.	Upper	Lower	Max.	Max.	Max.	Upper	Lower	Upper	Lower	Upper	Lower
50	80	0	-16	16	12	25	Depends on tolerance of ΔB_s in relation to d of the same bearing	Depends on tolerance of ΔB_{1s} in relation to d of the same bearing	Depends on tolerance of ΔB_{2s} in relation to d of the same bearing			
80	120	0	-18	18	14	35						
120	150	0	-20	20	15	40						
150	180	0	-25	25	19	45						
180	250	0	-30	30	23	50						
250	315	0	-35	35	26	60						
315	400	0	-40	40	30	70						
400	500	0	-45	45	34	80						
500	630	0	-50	60	38	100						
630	800	0	-75	80	55	120						
800	1 000	0	-100	100	75	140						
1 000	1 250	0	-125	130	90	160						
1 250	1 600	0	-160	170	100	180						

Table 6.8 Tolerance of tapered roller bearings of J series (metric series)

Table 6.8 (1) Inner rings

Nominal bore diameter d mm	Deviation of mean bore diameter in a single plane Δd_{mp}								Variation of bore diameter in a single plane V_{dsp}				Variation of mean bore diameter V_{dmp}				Axial runout of inner ring of assembled bearing S_{ia} Class B Max.	
	Class K		Class N		Class C		Class B		Class K	Class N	Class C	Class B	Class K	Class N	Class C	Class B		
	Upper	Lower	Upper	Lower	Upper	Lower	Upper	Lower										Max.
10	18	0	-12	0	-12	0	-7	0	-5	12	12	4	3	9	9	5	4	3
18	30	0	-12	0	-12	0	-8	0	-6	12	12	4	3	9	9	5	4	4
30	50	0	-12	0	-12	0	-10	0	-8	12	12	4	3	9	9	5	5	4
50	80	0	-15	0	-15	0	-12	0	-9	15	15	5	3	11	11	5	5	4
80	120	0	-20	0	-20	0	-15	0	-10	20	20	5	3	15	15	5	5	5
120	180	0	-25	0	-25	0	-18	0	-13	25	25	5	3	19	19	5	7	7
180	250	0	-30	0	-30	0	-22	0	-15	30	30	6	4	23	23	5	8	8

Note: Please consult NTN Engineering for Class A bearings.

Table 6.8 (2) Outer rings

Nominal outside diameter D mm	Deviation of mean outside diameter in a single plane ΔD_{mp}								Variation of outside diameter in a single plane V_{Dsp}				Variation of mean outside diameter V_{Dmp}				Axial runout of outer ring of assembled bearing S_{ea} Class B Max.	
	Class K		Class N		Class C		Class B		Class K	Class N	Class C	Class B	Class K	Class N	Class C	Class B		
	Upper	Lower	Upper	Lower	Upper	Lower	Upper	Lower										Max.
18	30	0	-12	0	-12	0	-8	0	-6	12	12	4	3	9	9	5	4	3
30	50	0	-14	0	-14	0	-9	0	-7	14	14	4	3	11	11	5	5	3
50	80	0	-16	0	-16	0	-11	0	-9	16	16	4	3	12	12	6	5	4
80	120	0	-18	0	-18	0	-13	0	-10	18	18	5	3	14	14	7	5	4
120	150	0	-20	0	-20	0	-15	0	-11	20	20	5	3	15	15	8	6	4
150	180	0	-25	0	-25	0	-18	0	-13	25	25	5	3	19	19	9	7	5
180	250	0	-30	0	-30	0	-20	0	-15	30	30	6	4	23	23	10	8	6
250	315	0	-35	0	-35	0	-25	0	-18	35	35	8	5	26	26	13	9	6
315	400	0	-40	0	-40	0	-28	0	-20	40	40	10	5	30	30	14	10	6

Note: Please consult NTN Engineering for Class A bearings.

Table 6.8 (3) Effective width of inner subunits and outer rings

Nominal bore diameter d mm	Deviation of the actual effective width of inner subunit assembled with a master outer ring ΔT_{1s}								Deviation of the actual effective width of outer ring assembled with a master inner subunit ΔT_{2s}								
	Class K		Class N		Class C		Class B		Class K	Class N	Class C	Class B	Class K	Class N	Class C	Class B	
	Upper	Lower	Upper	Lower	Upper	Lower	Upper	Lower									Upper
10	80	+100	0	+50	0	+100	-100	*	*	+100	0	+50	0	+100	-100	*	*
80	120	+100	-100	+50	0	+100	-100	*	*	+100	-100	+50	0	+100	-100	*	*
120	180	+150	-150	+50	0	+100	-100	*	*	+200	-100	+100	0	+100	-150	*	*
180	250	+150	-150	+50	0	+100	-150	*	*	+200	-100	+100	0	+100	-150	*	*

Note: 1. " * " mark bearings are manufactured only for combined bearings.
2. Please consult NTN Engineering for Class A bearings.

Unit: μm

Deviation of the actual assembled bearing width ΔT_s							
Class K		Class N		Class C		Class B	
Upper	Lower	Upper	Lower	Upper	Lower	Upper	Lower
+200	0	+100	0	+200	-200	+200	-200
+200	0	+100	0	+200	-200	+200	-200
+200	0	+100	0	+200	-200	+200	-200
+200	0	+100	0	+200	-200	+200	-200
+200	-200	+100	0	+200	-200	+200	-200
+350	-250	+150	0	+350	-250	+200	-250
+350	-250	+150	0	+350	-300	+200	-300

Table 6.8 (4) Radial runout of inner and outer rings

Nominal outside diameter D mm	Radial runout of inner ring of assembled bearing K_{ia}				Radial runout of outer ring of assembled bearing K_{ea}				
	Class K		Class N		Class C		Class B		
	Upper	Lower	Upper	Lower	Upper	Lower	Upper	Lower	
18	30	18	18	5	3	18	18	5	3
30	50	20	20	6	3	20	20	6	3
50	80	25	25	6	4	25	25	6	4
80	120	35	35	6	4	35	35	6	4
120	150	40	40	7	4	40	40	7	4
150	180	45	45	8	4	45	45	8	4
180	250	50	50	10	5	50	50	10	5
250	315	60	60	11	5	60	60	11	5
315	400	70	70	13	5	70	70	13	5

Note: Please consult NTN Engineering for Class A bearings.

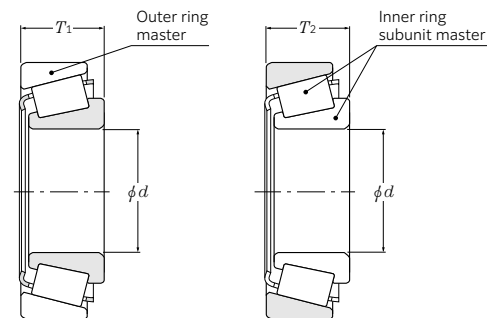

Table 6.9 Tolerance of thrust ball bearings

Table 6.9 (1) Shaft washer

Unit: μm

Nominal bore diameter		Deviation of mean bore diameter in a single plane				Variation of bore diameter in a single plane		Variation in thickness between shaft washer raceway and back face			
d mm		Δd_{mp}				V_{dsp}		S_i			
Over	Incl.	Class 0, 6, 5		Class 4		Class 0, 6, 5	Class 4	Class 0	Class 6	Class 5	Class 4
		Upper	Lower	Upper	Lower						
—	18	0	-8	0	-7	6	5	10	5	3	2
18	30	0	-10	0	-8	8	6	10	5	3	2
30	50	0	-12	0	-10	9	8	10	6	3	2
50	80	0	-15	0	-12	11	9	10	7	4	3
80	120	0	-20	0	-15	15	11	15	8	4	3
120	180	0	-25	0	-18	19	14	15	9	5	4
180	250	0	-30	0	-22	23	17	20	10	5	4
250	315	0	-35	0	-25	26	19	25	13	7	5
315	400	0	-40	0	-30	30	23	30	15	7	5
400	500	0	-45	0	-35	34	26	30	18	9	6
500	630	0	-50	0	-40	38	30	35	21	11	7

Table 6.9 (2) Housing washer

Unit: μm

Nominal outside diameter		Deviation of mean outside diameter in a single plane				Variation of outside diameter in a single plane		Variation in thickness between housing washer raceway and back face			
D mm		ΔD_{mp}				V_{Dsp}		S_e			
Over	Incl.	Class 0, 6, 5		Class 4		Class 0, 6, 5	Class 4	Class 0, 6, 5, 4	Class 0, 6, 5, 4	Class 0, 6, 5, 4	Class 0, 6, 5, 4
		Upper	Lower	Upper	Lower						
10	18	0	-11	0	-7	8	5	Depends on tolerance of S_i against d of the same bearings			
18	30	0	-13	0	-8	10	6				
30	50	0	-16	0	-9	12	7				
50	80	0	-19	0	-11	14	8				
80	120	0	-22	0	-13	17	10				
120	180	0	-25	0	-15	19	11				
180	250	0	-30	0	-20	23	15				
250	315	0	-35	0	-25	26	19				
315	400	0	-40	0	-28	30	21				
400	500	0	-45	0	-33	34	25				
500	630	0	-50	0	-38	38	29				
630	800	0	-75	0	-45	55	34				

Table 6.9 (3) Bearing height

Unit: μm

Nominal bore diameter		Deviation of the actual bearing height, single-direction bearing ¹⁾	
d mm		ΔT_s	
Over	Incl.	Upper	Lower
—	30	0	-75
30	50	0	-100
50	80	0	-125
80	120	0	-150
120	180	0	-175
180	250	0	-200
250	315	0	-225
315	400	0	-300
400	500	0	-350
500	630	0	-400

1) Applies to flat back face bearing of Class 0. The values are the NTN standard.

Table 6.10 Tolerance of spherical thrust roller bearings

Table 6.10 (1) Shaft washer

Unit: μm

Nominal bore diameter		Deviation of mean bore diameter in a single plane		Variation of bore diameter in a single plane	Perpendicularity of shaft washer back face with respect to the bore ¹⁾	Deviation of the actual bearing height ¹⁾	
d mm		Δd_{mp}		V_{dsp}	S_d	ΔT_s	
Over	Incl.	Upper	Lower	Max.	Max.	Upper	Lower
80	120	0	-20	15	25	+200	-200
120	180	0	-25	19	30	+250	-250
180	250	0	-30	23	30	+300	-300
250	315	0	-35	26	35	+350	-350
315	400	0	-40	30	40	+400	-400
400	500	0	-45	34	45	+450	-450

1) The standard conforms to JIS B 1539.

Table 6.10 (2) Housing washer

Unit: μm

Nominal outside diameter		Deviation of mean outside diameter in a single plane	
D mm		ΔD_{mp}	
Over	Incl.	Upper	Lower
120	180	0	-25
180	250	0	-30
250	315	0	-35
315	400	0	-40
400	500	0	-45
500	630	0	-50
630	800	0	-75
800	1 000	0	-100

6.3 Chamfer measurements and tolerance or allowable values of tapered bore

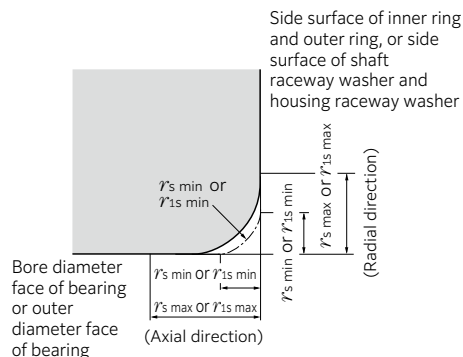

Table 6.11 Allowable critical-value of bearing chamfer

Table 6.11 (1) Radial bearings (except tapered roller bearing)

$r's \text{ min}^{(1)}$ or $r'1s \text{ min}$	Nominal bore diameter d		$r's \text{ max}$ Of $r'1s \text{ max}$	
	Over	Incl.	Radial direction	Axial direction
0.05	-	-	0.1	0.2
0.08	-	-	0.16	0.3
0.1	-	-	0.2	0.4
0.15	-	-	0.3	0.6
0.2	-	-	0.5	0.8
0.3	-	40	0.6	1
	40	-	0.8	1
0.6	-	40	1	2
	40	-	1.3	2
1	-	50	1.5	3
	50	-	1.9	3
1.1	-	120	2	3.5
	120	-	2.5	4
1.5	-	120	2.3	4
	120	-	3	5
2	-	80	3	4.5
	80	220	3.5	5
	220	-	3.8	6
2.1	-	280	4	6.5
	280	-	4.5	7
2.5	-	100	3.8	6
	100	280	4.5	6
	280	-	5	7
3	-	280	5	8
	280	-	5.5	8
4	-	-	6.5	9
5	-	-	8	10
6	-	-	10	13
7.5	-	-	12.5	17
9.5	-	-	15	19
12	-	-	18	24
15	-	-	21	30
19	-	-	25	38

1) These are the allowable minimum dimensions of the chamfer dimension "r" or "r1" and are described in the dimensional table.

Table 6.11 (2) Tapered roller bearings of metric series

$r's \text{ min}^{(2)}$ or $r'1s \text{ min}$	Nominal bore diameter d (3) or nominal outside diameter D		$r's \text{ max}$ Of $r'1s \text{ max}$	
	Over	Incl.	Radial direction	Axial direction
0.3	-	40	0.7	1.4
	40	-	0.9	1.6
0.6	-	40	1.1	1.7
	40	-	1.3	2
1	-	50	1.6	2.5
	50	-	1.9	3
1.5	-	120	2.3	3
	120	250	2.8	3.5
	250	-	3.5	4
2	-	120	2.8	4
	120	250	3.5	4.5
	250	-	4	5
2.5	-	120	3.5	5
	120	250	4	5.5
	250	-	4.5	6
3	-	120	4	5.5
	120	250	4.5	6.5
	250	400	5	7
	400	-	5.5	7.5
4	-	120	5	7
	120	250	5.5	7.5
	250	400	6	8
	400	-	6.5	8.5
5	-	180	6.5	8
	180	-	7.5	9
6	-	180	7.5	10
	180	-	9	11

2) These are the allowable minimum dimensions of the chamfer dimension "r" or "r1" and are described in the dimensional table.

3) Inner rings shall be in accordance with the division of "d" and outer rings with that of "D".

Note: The standard applies to the bearings whose dimensional series (refer to the dimensional table) are specified in the standard ISO 355 or JIS B 1512. For further information concerning bearings outside of these standards or tapered roller bearings using a US customary unit, please contact NTN Engineering.

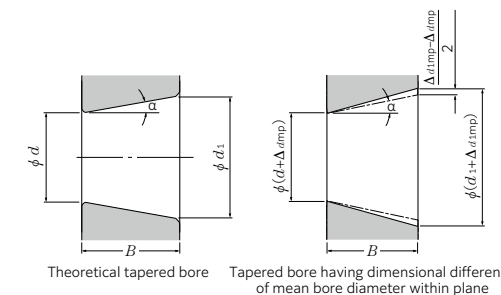

Table 6.12 (1) Tolerance of tapered bores of radial bearings and tapered bores with allowable standard taper ratio 1:12 (Class 0)

d mm	Incl.	Δd_{mp}		$\Delta d_{1mp} - \Delta d_{mp}$		$V_{dsp}^{(1)(2)}$ Max.
		Upper	Lower	Upper	Lower	
10	18	+22	0	+15	0	9
18	30	+27	0	+18	0	11
		+33	0	+21	0	13
30	50	+39	0	+25	0	16
50	80	+46	0	+30	0	19
80	120	+54	0	+35	0	22
120	180	+63	0	+40	0	40
180	250	+72	0	+46	0	46
250	315	+81	0	+52	0	52
315	400	+89	0	+57	0	57
400	500	+97	0	+63	0	63
500	630	+110	0	+70	0	70
630	800	+125	0	+80	0	-
800	1000	+140	0	+90	0	-
1000	1250	+165	0	+105	0	-
1250	1600	+195	0	+125	0	-

Table 6.12 (2) Tolerance of tapered bores of radial bearings and tapered bores with allowable standard taper ratio 1:30 (Class 0)

d mm	Incl.	Δd_{mp}		$\Delta d_{1mp} - \Delta d_{mp}$		$V_{dsp}^{(1)(2)}$ Max.
		Upper	Lower	Upper	Lower	
50	80	+15	0	+30	0	19
80	120	+20	0	+35	0	22
120	180	+25	0	+40	0	40
180	250	+30	0	+46	0	46
250	315	+35	0	+52	0	52
315	400	+40	0	+57	0	57
400	500	+45	0	+63	0	63
500	630	+50	0	+70	0	70

1) Applies to all radial flat planes of tapered bores.

2) Does not apply to diameter series 7 and 8.

Note: Quantifiers

For a standard taper ratio of $\frac{1}{12}$, $d_1 = d + \frac{1}{12} B$

For a standard taper ratio of $\frac{1}{30}$, $d_1 = d + \frac{1}{30} B$

Δd_{mp} : Dimensional difference of the mean bore diameter within the flat surface at the theoretical small end of the tapered bore

Δd_{1mp} : Dimensional difference of the mean bore diameter within the flat surface at the theoretical large end of the tapered bore

V_{dsp} : Unevenness of the bore diameter with the flat surface

B : Nominal width of inner ring

α : $\frac{1}{2}$ of the tapered bore's standard taper angle

For a standard taper ratio of $\frac{1}{12}$ For standard taper ratio of $\frac{1}{30}$

$\alpha = 2^{\circ}23'9.4''$ $\alpha = 0^{\circ}57'17.4''$

$= 2.38594^{\circ}$ $= 0.95484^{\circ}$

$= 0.041643 \text{ rad}$ $= 0.016665 \text{ rad}$

Table 6.11 (3) Thrust bearings

$r's \text{ min}$ Of $r'1s \text{ min}^{(4)}$	$r's \text{ max}$ Of $r'1s \text{ max}$ Radial and axial directions
0.05	0.1
0.08	0.16
0.1	0.2
0.15	0.3
0.2	0.5
0.3	0.8
0.6	1.5
1	2.2
1.1	2.7
1.5	3.5
2	4
2.1	4.5
3	5.5
4	6.5
5	8
6	10
7.5	12.5
9.5	15
12	18
15	21
19	25

4) These are the allowable minimum dimensions of the chamfer dimension "r" or "r1" and are described in the

6.4 Bearing tolerance measurement methods

For reference, measurement methods for rolling bearing tolerances are specified in JIS B 1515-2.

Table 6.13 shows some of the major methods of measuring rotation tolerances.

Table 6.13 Rotation tolerance measurement methods

Accuracy characteristics	Measurement methods
Radial runout of inner ring of assembled bearing (K_{ia})	<p>Radial runout of the inner ring is the difference between the maximum and minimum reading of the measuring device when the inner ring is turned one revolution.</p>
Radial runout of outer ring of assembled bearing (K_{ea})	<p>Radial runout of the outer ring is the difference between the maximum and minimum reading of the measuring device when the outer ring is turned one revolution.</p>
Axial runout of inner ring of assembled bearing (S_{ia})	<p>Axial runout of the inner ring is the difference between the maximum and minimum reading of the measuring device when the inner ring is turned one revolution.</p>
Axial runout of outer ring of assembled bearing (S_{ea})	<p>Axial runout of the outer ring is the difference between the maximum and minimum reading of the measuring device when the outer ring is turned one revolution.</p>
Perpendicularity of inner ring face with respect to the bore (S_D)	<p>The squareness of the inner ring side surface is the difference between the maximum and minimum readings of the measuring device when the inner ring is turned one revolution together with the tapered mandrel.</p>
Perpendicularity of outer ring outside surface with respect to the face (S_D)	<p>The squareness of the outer ring outer diameter surface is the difference between the maximum and minimum readings of the measuring device when the outside ring is turned one revolution along the reinforcing plate.</p>

6.5 Geometrical product specifications (GPS)

GPS is an abbreviation of geometrical product specifications. GPS is the new drawing notation for accurately describing the geometrical specifications of product shapes, dimensions, and surface characteristics. The standard that specifies rules for making drawings with GPS is called "GPS standard."

<Purpose of GPS>

While conventional drawing notation typically describes product dimensions and characteristics accurately, there are several "unclear" aspects of the conventional notation that can lead to varying interpretations (see Fig. 6.2). The main purpose of the GPS is to eliminate the ambiguity of drawing notation, thereby preventing troubles.

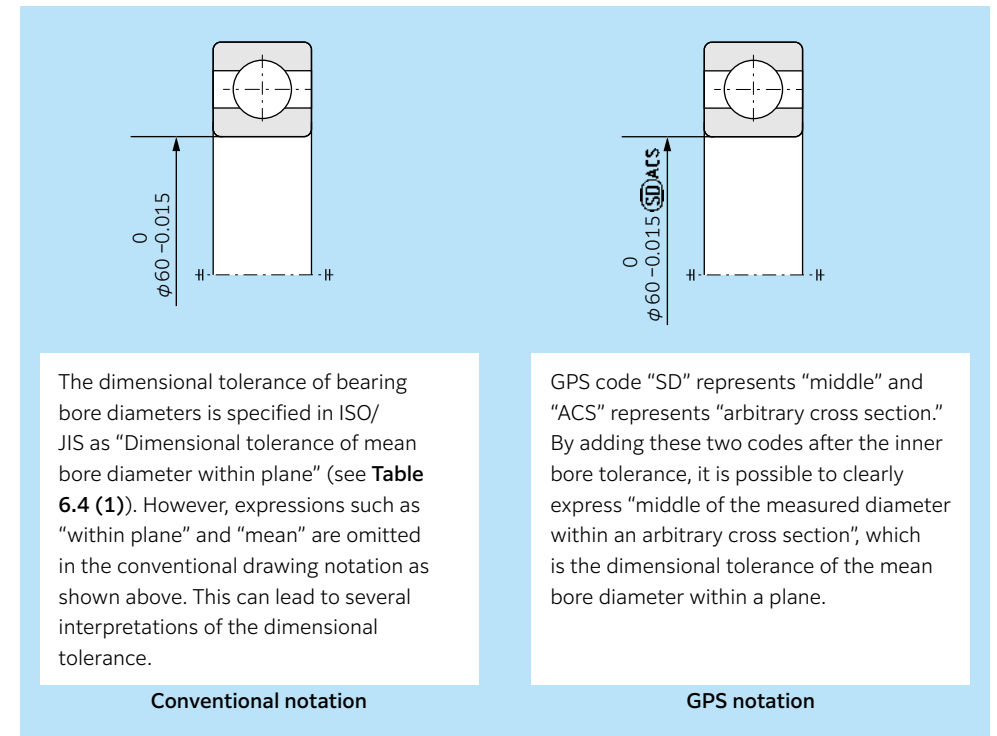

Fig. 6.2 Notation example of bearing bore diameter tolerance

<Applying GPS to rolling bearings>

In regards to standards related to roller bearings, ISO 492 specifying the tolerance of radial bearings and ISO 199 specifying the tolerance of thrust bearings were revised with GPS in 2014. In response to this, JIS B 1514-1 and JIS B 1514-2 were also revised in 2017.

<Example of bearing drawing applying GPS>

Fig. 6.3 shows an example of a bearing drawing that uses GPS.

Drawings that use GPS include notations and codes that are different from the ones used in conventional drawings.

For details, please contact **NTN Engineering**.

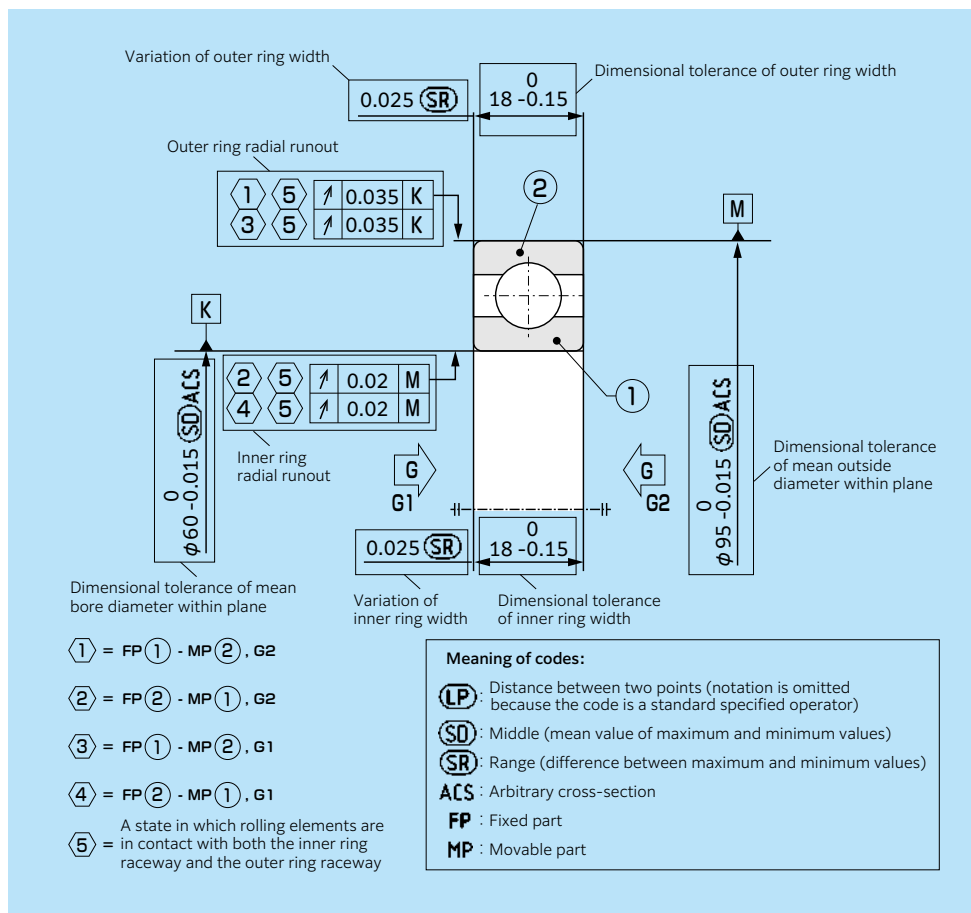

Fig. 6.3 Example of bearing drawing applying GPS

7. Bearing fits

7.1 Resultant fits

For rolling bearings, it is necessary to fix inner and outer rings on the shaft or in the housing so that relative movement does not occur between fitting surfaces during operation or under load. This relative movement between the mating surfaces of the bearing and the shaft or housing can occur in a radial direction, an axial direction, or in the direction of rotation. Types of resultant fit include **tight, transition** and **loose fits**, which describe whether or not there is interference between the bearing and the shaft or housing.

The most effective way to fix the mating surfaces between a bearing and shaft or housing is to apply a "tight fit." The advantage of a tight fit for thin walled bearings is that it provides uniform load support over the entire ring circumference without any loss of load carrying capacity. However, with a tight fit, ease of installation and disassembly is lost; and when using a non-separable bearing as the floating-side bearing, axial displacement is not possible. For this reason, a tight fit cannot be recommended in all cases.

7.2 The necessity of a proper fit

In some cases, an improper fit may lead to damage and shorten bearing life. Therefore it is necessary to carefully select the proper fit. Some possible bearing failures caused by an improper fit are listed below.

- Raceway cracking, early flaking and displacement of raceway
- Raceway and shaft or housing abrasion caused by creeping and fretting corrosion
- Seizing caused by negative internal clearances
- Increased noise and deteriorated rotational accuracy due to raceway groove deformation

Please refer to "16. Bearing Damage and Corrective Measures" for information concerning diagnosis of these conditions.

7.3 Fit selection







Selection of a proper fit is dependent upon thorough analysis of bearing operating conditions, including consideration of:

- Shaft and housing material, wall thickness, surface finish accuracy, etc.
- Machinery operating conditions (nature and magnitude of load, rotational speed, temperature, etc.)

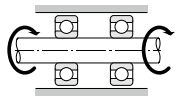
7.3.1 "Tight fit" or "Loose fit"

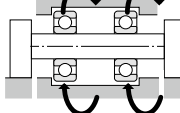
- (1) For bearing rings under rotating loads, a **tight fit** is necessary. (Refer to **Table 7.1**) "Raceways under rotating loads" refers to raceways receiving loads rotating relative to their radial direction.
For bearing rings under static loads, on the other hand, a **loose fit** is sufficient.
(Example) Rotating inner ring load = the direction of the radial load on the inner ring is rotating relatively
- (2) For non-separable bearings, such as deep groove ball bearings, it is generally recommended that either the inner ring or outer ring be given a **loose fit**.

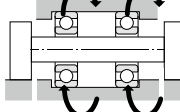
Table 7.1 Radial load and bearing fit

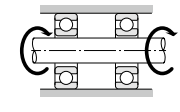
Design	Bearing rotation	Ring load	Fit
Static load 	Inner ring: Rotating Outer ring: Stationary 	Rotating inner ring load	Inner ring: Tight fit
Unbalanced load 	Inner ring: Stationary Outer ring: Rotating 	Static outer ring load	Outer ring: Loose fit
Static load 	Inner ring: Stationary Outer ring: Rotating 	Static inner ring load	Inner ring: Loose fit
Unbalanced load 	Inner ring: Rotating Outer ring: Stationary 	Rotating outer ring load	Outer ring: Tight fit

7.3.2 Recommended fits

Bearing fit is governed by the tolerances selected for bearing shaft diameters and housing bore diameters.

Widely used fits for Class 0 tolerance bearings and various shaft and housing bore diameter tolerances are shown in **Fig. 7.1**.

Generally-used, standard fits for most types of bearings and operating conditions are shown in **Tables 7.2 to 7.7**.

- Table 7.2:** Fits for radial bearings
- Table 7.3:** Fits for thrust bearings
- Table 7.4:** Fits for electric motor bearings
- Table 7.6:** Inch series tapered roller bearings Fits of (ANSI/ABMA CLASS 4)
- Table 7.7:** Inch series tapered roller bearings Fits of (ANSI/ABMA CLASS 3, CLASS 0)

Table 7.5 shows fits and their numerical values.

For special fits or applications, please consult **NTN Engineering**.

7.3.3 Interference minimum and maximum values

The following points should be considered when it is necessary to calculate the interference for an application:

- Regarding minimum values,
 - 1) interference is reduced by radial loads
 - 2) interference is reduced by differences between bearing temperature and ambient temperature
 - 3) interference is reduced by variation in mating surface
 - 4) interference is reduced by deformation
- The upper limit value should not exceed 1/ 1 000 of the shaft diameter.

Required interference calculations are shown below.

(1) Mating surface variation and interference

Interference decreases because the mating surface is smoothed by the resultant fit (surface roughness is reduced). The amount

the interference decreases depends on the roughness of the mating surfaces. It is generally necessary to anticipate the following decrease in interference.

- For ground shafts: 1.0 to 2.5 μm
- For machined shafts: 5.0 to 7.0 μm

The interference including this decrease amount is called effective interference.

(2) Radial loads and required interference

Interference of the inner ring and shaft decreases when a radial load is applied to the bearing. The interference required for installation to solid shafts is expressed by formulae (7.1) and (7.2) for each load condition.

General applications ($F_r \leq 0.3C_{0r}$)
 $\Delta d_F = 0.08(d \cdot F_r / B)^{1/2}$ N(7.1)
 Under heavy load conditions ($F_r > 0.3 C_{0r}$)
 $\Delta d_F = 0.02(F_r / B)$ N(7.2)

- Where:
- Δd_F : Required effective interference according to radial load μm
 - d : Bearing bore mm
 - B : Inner ring width mm
 - F_r : Actual radial load, N
 - C_{0r} : Basic static load rating N

For solid shafts, please contact **NTN Engineering**.

(3) Temperature difference and required interference

Interference between inner rings and steel shafts is reduced as a result of temperature increases (difference between bearing temperature and ambient temperature, ΔT) caused by bearing rotation. Calculation of the minimum required amount of interference in such cases is shown in formula (7.3).

$\Delta d_T = 0.0015 \cdot d \cdot \Delta T$ (7.3)
 Δd_T : Required effective interference for temperature difference μm
 ΔT : Difference between inner ring temperature and ambient temperature $^{\circ}\text{C}$
 d : Bearing bore mm

(4) Maximum interference

When bearing rings are installed with an interference fit, tensile or compressive stress may occur along their raceways. If interference is too great, this may cause damage to the rings and reduce bearing life. The maximum stress due to the resultant fit must not exceed approximately 127 MPa for safety. If the value is to be exceeded, consult NTN Engineering.

See section "17.4 Resultant fit surface pressure" for the calculation method of maximum stress due to the resultant fit.

(5) Interference change amount when materials other than steel are used for shafts and housings

When materials other than steel are used for shafts and housings, the fits between the inner ring and the shaft and the outer ring and the housing change because of difference in the expansion coefficient of each material as the temperature rises during the rotation of the bearing. Therefore, it is necessary to set the resultant fit with expansion coefficients in consideration. The calculation formula of the change in interference is shown below.

$$\Delta d_{TE} = (\alpha_1 - \alpha_2) \times d \times \Delta T$$

Δd_{TE} : Change in interference caused by difference in the expansion coefficients mm

α_1 : Bearing expansion coefficient 1/°C

α_2 : Shaft and housing expansion coefficient 1/°C

d : Reference dimension of resultant fit mm

ΔT : Temperature increase by bearing rotation °C

(Expansion coefficient: See **Table 13.19** in "13. Bearing Materials.")

7.3.4 Other details

- (1) Large interference fits are recommended for,
 - Operating conditions with large vibrations or shock loads
 - Applications using hollow shafts or housings with thin walls
 - Applications using housings made of light alloys or plastic
- (2) Small interference fits are preferable for,
 - Applications requiring high running accuracy
 - Applications using small sized bearings or thin walled bearings
- (3) Consideration must also be given to the fact that fit selection will effect internal bearing clearance selection. (refer to page A-88.)
- (4) A particular type of fit is recommended for SL type cylindrical roller bearings. (refer to page C-67.)
- (5) Bearing dimensions are measured and managed at a temperature of 20°C.

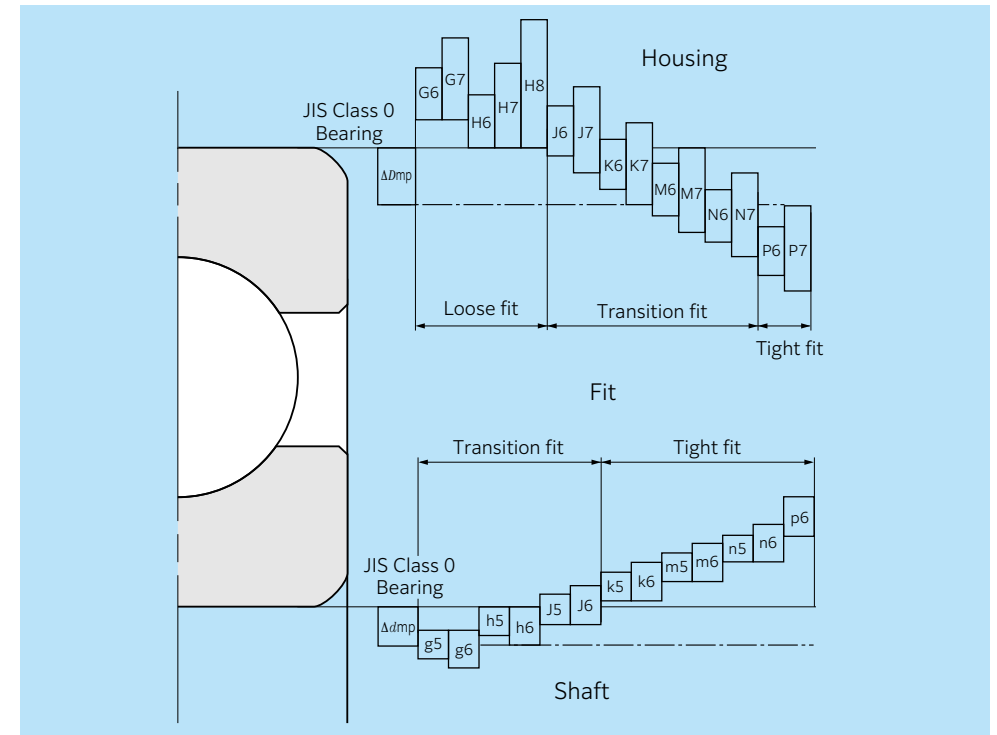

Fig 7.1 State of resultant fit

Table 7.2 General standards for radial bearing fits (JIS Class 0, 6X, 6)

Table 7.2 (1) Tolerance class of shafts commonly used for radial bearings (classes 0, 6X and 6)

Condition No.	Ball bearing		Cylindrical roller bearing Tapered roller bearing		Self-aligning roller bearing		Shaft tolerance class	Remarks	
	Shaft diameter (mm)								
	Over	Incl.	Over	Incl.	Over	Incl.			
Cylindrical bore bearing (Classes 0, 6X and 6)									
Inner ring rotational load or load of undetermined direction	Light load ¹⁾ or Fluctuating load	—	18	—	—	—	—	h5 js6 k6 m6	When greater accuracy is required js5, k5, and m5 may be substituted for js6, k6, and m6. Alteration of inner clearances to accommodate fit is not a consideration with single-row angular contact bearings and tapered roller bearings. Therefore, k5 and m5 may be substituted for k6 and m6. Use bearings with larger internal clearances than CN clearance bearings.
		18	100	—	40	—	40		
	Normal load ¹⁾	—	18	—	—	—	—	js5 k5 m5 m6 n6 p6 r6	
		18	100	—	40	—	40		
Heavy load ¹⁾ or Impact load	—	—	50	140	50	100	n6 p6 r6		
	—	—	140	200	100	140			
Static inner ring load	Inner ring must move easily over shaft	Overall shaft diameter						g6	When greater accuracy is required use g5. For large bearings, f6 will suffice to facilitate movement.
	Inner ring does not have to move easily over shaft	Overall shaft diameter						h6	When greater accuracy is required use h5.
Center axial load	Overall shaft diameter						js6	Generally, shaft and inner rings are not fixed using resultant fits.	
Tapered bore bearing (class 0) (with adapter or withdrawal sleeve)									
Full load	Overall shaft diameter						h9/IT5 ²⁾	h10/IT7 ²⁾ will suffice for power transmitting shafts.	

Table 7.2 (2) Fit with shaft (fits for tapered bore bearings (Class 0) with adapter assembly/ withdrawal sleeve)

Full load	All bearing types	Tolerance class	h9 / IT5 ²⁾	General applications
			H10 / IT7 ²⁾	Transmission shafts, etc.

1) Standards for light loads, normal loads, and heavy loads
 { Light loads: dynamic equivalent radial load $\leq 0.05 Cr$
 Normal loads: $0.05 Cr \leq$ dynamic equivalent radial load $\leq 0.10 Cr$
 Heavy loads: $0.10 Cr <$ dynamic equivalent radial load

2) IT5 and IT7 show shaft roundness tolerances, cylindricity tolerances, and related values.

Note: All values and fits listed in the above tables are for solid steel shafts.

Table 7.2 (3) Tolerance class of housing bores commonly used for radial bearings (classes 0, 6X and 6)

Housing	Conditions		Housing bore tolerance class	Remarks
	Load type, etc.	Outer ring axial direction movement ³⁾		
Single housing or Divided housing	Static outer ring load	All types of loads	Yes	H7 G7 can be used for large bearings or bearings with large temperature differential between the outer ring and housing.
		Light ¹⁾ or ordinary load ¹⁾	Yes	H8 —
		Shaft and inner ring become hot	Easily	G7 F7 be used for large bearings or bearings with large temperature differential between the outer ring and housing.
Single housing	Indeterminate load	Requires precise rotation under light or ordinary loads	As a rule, it cannot move.	K6 Primarily applies to roller bearings.
			Yes	Js6 Primarily applies to ball bearings.
	Rotating outer ring load	Light or ordinary load	Yes	Js7 If high accuracy is required, Js6 and K6 are used in place of Js7 and K7.
			As a rule, it cannot move.	K7 —
	Rotating outer ring load	Ordinary or heavy load ¹⁾	No	M7 —
			No	N7 Primarily applies to ball bearings.
Rotating outer ring load	Heavy load or large impact load with thin wall housing ²⁾	No	P7 Primarily applies to roller bearings.	

1) Standards for light loads, normal loads, and heavy loads

{ Light loads: dynamic equivalent radial load $\leq 0.05 Cr$
 Normal loads: $0.05 Cr \leq$ dynamic equivalent radial load $\leq 0.10 Cr$
 Heavy loads: $0.10 Cr <$ dynamic equivalent radial load

2) The axial direction needs to be secured because the outer ring may move in the shaft direction, causing problems, depending on the use. (Example: planetary gear, etc.)

3) Indicates whether or not outer ring axial movement is possible with non-separable type bearings.

Note: 1. All values and fits listed in the above tables are for cast iron or steel housings.

2. If only a center axial load is applied to the bearing, select a tolerance class that provides clearance for the outer ring in the radial direction.

Table 7.3 Standard fits for thrust bearings (JIS Class 0 and 6)

Table 7.3 (1) Shaft fits

Bearing type	Load conditions		Fit	Shaft diameter mm Over Incl.	Tolerance class
All thrust bearings	Centered axial load only		Transition fit	Overall shaft diameter	js6 or h6
Self-aligning roller thrust bearing	Combined load	Static inner ring load	Transition fit	Overall shaft diameter	js6
		Rotating inner ring load or Indeterminate load	Transition fit Tight fit	Up to 200 400 to 200 400 or more	k6 or js6 m6 or k6 n6 or m6

Table 7.3 (2) Housing fits

Bearing type	Load conditions		Fit	Tolerance class	Remarks
All thrust bearings	Centered axial load only		Loose fit	H8 H7	Select a tolerance class that will provide clearance between outer ring and housing. Greater accuracy required with thrust ball bearings
Self-aligning roller thrust bearing	Combined load	Static outer ring load			Transition fit
		Indeterminate load or Rotating outer ring load	M7	For relatively large radial loads	

Note: All values and fits listed in the above tables are for cast iron or steel housings.

Table 7.4 Fits for electric motor bearings

Bearing type	Shaft fits		Housing fits	
	Shaft diameter mm Over Incl.	Tolerance class	Housing bore diameter	Tolerance class
Deep groove ball bearing	~ 18 18 ~ 100 100 ~ 160	j5 k5 m5	All sizes	H6 or J6
Cylindrical roller bearing	~ 40 40 ~ 160 160 ~ 200	k5 m5 n6	All sizes	H6 or J6

Table 7.6 General fit standards for tapered roller bearings using US customary unit (ANSI class 4)

Table 7.6 (1) Fit with shaft

Unit: μm

Operating conditions	Nominal bearing bore diameter d mm Over Incl.	Bore diameter tolerance Δ_{ds}		Shaft diameter tolerance		Fit ¹⁾	Remarks
		Upper	Lower	Upper	Lower		
Rotating inner ring load Normal load	~ 76.2	+13	0	+ 38	+ 25	38T ~ 13T	Applicable when a slight impact load is applied as well.
	76.2 ~ 304.8	+25	0	+ 64	+ 38	64T ~ 13T	
	304.8 ~ 609.6	+51	0	+127	+ 76	127T ~ 25T	
Rotating inner ring load Heavy load Impact load	~ 76.2	+13	0	+ 64	+ 38	64T ~ 25T	0.5 μm mean interference per 1 mm of inner ring bore diameter. Minimum interference is 25 μm . Tolerance for the shaft is adjusted to match tolerance of bearing bore diameter.
	76.2 ~ 304.8	+25	0				
	304.8 ~ 609.6	+51	0				
Rotating inner ring load Impact load	609.6 ~ 914.4	+76	0	+457	+381	457T ~ 305T	
	~ 76.2	+13	0	+ 13	0	13T ~ 13L	Not applicable when impact load is applied.
	76.2 ~ 304.8	+25	0	+ 25	0	25T ~ 25L	
304.8 ~ 609.6	+51	0	+ 51	0	51T ~ 51L		
Rotating outer ring load Inner ring does not have to move easily over shaft with an ordinary load.	609.6 ~ 914.4	+76	0	+ 76	0	76T ~ 76L	
	~ 76.2	+13	0	0	-13	0 ~ 13L	
	76.2 ~ 304.8	+25	0	0	-25	0 ~ 51L	
304.8 ~ 609.6	+51	0	0	-51	0 ~ 102L		
Rotating outer ring load Inner ring must move easily over shaft with an ordinary load.	609.6 ~ 914.4	+76	0	0	-76	0 ~ 152L	

Table 7.6 (2) Fit with housing

Unit: μm

Operating conditions	Nominal bearing outside diameter D mm Over Incl.	Outer diameter dimensional tolerance Δ_{Ds}		Housing bore diameter tolerance		Fit ¹⁾	Types of fits
		Upper	Lower	Upper	Lower		
Rotating inner ring load When used on floating or fixed side	~ 76.2	+25	0	+ 76	+ 51	25L ~ 76L	Loose fit
	76.2 ~ 127.0	+25	0	+ 76	+ 51	25L ~ 76L	
	127.0 ~ 304.8	+25	0	+ 76	+ 51	25L ~ 76L	
	304.8 ~ 609.6	+51	0	+152	+102	51L ~ 152L	
	609.6 ~ 914.4	+76	0	+229	+152	76L ~ 229L	
Rotating inner ring load When outer ring is adjusted in the axial direction	~ 76.2	+25	0	+ 25	0	25T ~ 25L	Transition fit
	76.2 ~ 127.0	+25	0	+ 25	0	25T ~ 25L	
	127.0 ~ 304.8	+25	0	+ 51	0	25T ~ 51L	
	304.8 ~ 609.6	+51	0	+ 76	+ 25	25T ~ 76L	
Rotating inner ring load When outer ring is not adjusted in the axial direction	609.6 ~ 914.4	+76	0	+127	+ 51	25T ~ 127L	Tight fit
	~ 76.2	+25	0	- 13	- 38	64T ~ 13T	
	76.2 ~ 127.0	+25	0	- 25	- 51	76T ~ 25T	
	127.0 ~ 304.8	+25	0	- 25	- 51	76T ~ 25T	
Rotating outer ring load When outer ring is not adjusted in the axial direction	304.8 ~ 609.6	+51	0	- 25	- 76	127T ~ 25T	Tight fit
	609.6 ~ 914.4	+76	0	- 25	-102	178T ~ 25T	
	~ 76.2	+25	0	- 13	- 38	64T ~ 13T	
	76.2 ~ 127.0	+25	0	- 25	- 51	76T ~ 25T	
Rotating outer ring load When outer ring is not adjusted in the axial direction	127.0 ~ 304.8	+25	0	- 25	- 51	76T ~ 25T	Tight fit
	304.8 ~ 609.6	+51	0	- 25	- 76	127T ~ 25T	
	609.6 ~ 914.4	+76	0	- 25	-102	178T ~ 25T	

1) Fit symbol "L" indicates clearance and "T" indicates interference.

Table 7.7 General fit standards for tapered roller bearings using US customary unit (ANSI classes 3 and 0)

Table 7.7 (1) Fit with shaft

Unit: μm

Operating conditions	Nominal bearing bore diameter d mm Over Incl.	Bore diameter tolerance Δ_{ds}		Shaft diameter tolerance		Fit ¹⁾
		Upper	Lower	Upper	Lower	
Rotating inner ring load Precision machine tool spindles	~ 304.8	+13	0	+ 30	+ 18	30T ~ 5T
	304.8 ~ 609.6	+25	0	+ 64	+ 38	64T ~ 13T
	609.6 ~ 914.4	+38	0	+102	+ 64	102T ~ 25T
Rotating inner ring load Heavy load Shock load High-speed rotation	~ 304.8	+13	0	Minimum interference is 0.25 μm per 1 mm of inner ring bore diameter		
	304.8 ~ 609.6	+25	0			
	609.6 ~ 914.4	+38	0			
Rotating outer ring load Precision machine tool spindles	~ 304.8	+13	0	+ 30	+ 18	30T ~ 5T
	304.8 ~ 609.6	+25	0	+ 64	+ 38	64T ~ 13T
	609.6 ~ 914.4	+38	0	+102	+ 64	102T ~ 25T

Note: For class 0, bearing bore diameter d applies to 304.8 mm or less.

Table 7.7 (2) Fit with housing

Unit: μm

Operating conditions	Nominal bearing bore diameter D mm Over Incl.	Outer diameter dimensional tolerance Δ_{Ds}		Housing bore diameter tolerance		Fit ¹⁾	Types of fits
		Upper	Lower	Upper	Lower		
Rotating inner ring load When used for floating-side	~ 152.4	+13	0	+38	+25	13L ~ 38L	Loose fit
	152.4 ~ 304.8	+13	0	+38	+25	13L ~ 38L	
	304.8 ~ 609.6	+25	0	+64	+38	13L ~ 64L	
	609.6 ~ 914.4	+38	0	+89	+51	13L ~ 89L	
	~ 152.4	+13	0	+25	+13	0 ~ 25L	
Rotating inner ring load When used for fixed side	152.4 ~ 304.8	+13	0	+25	+13	0 ~ 25L	Transition fit
	304.8 ~ 609.6	+25	0	+51	+25	0 ~ 51L	
	609.6 ~ 914.4	+38	0	+76	+38	0 ~ 76L	
	~ 152.4	+13	0	+13	0	13T ~ 13L	
Rotating inner ring load When outer ring is adjusted in axial direction	152.4 ~ 304.8	+13	0	+25	0	13T ~ 25L	Transition fit
	304.8 ~ 609.6	+13	0	+25	0	25T ~ 25L	
	609.6 ~ 914.4	+38	0	+38	0	38T ~ 38L	
Rotating inner ring load When outer ring is not adjusted in axial direction	~ 152.4	+13	0	0	-13	25T ~ 0	Tight fit
	152.4 ~ 304.8	+13	0	0	-25	38T ~ 0	
	304.8 ~ 609.6	+25	0	0	-25	51T ~ 0	
	609.6 ~ 914.4	+38	0	0	-38	76T ~ 0	
Rotating outer ring load Normal load When outer ring is not adjusted in the axial direction	~ 152.4	+13	0	-13	-25	38T ~ 13T	Tight fit
	152.4 ~ 304.8	+13	0	-13	-38	51T ~ 13T	
	304.8 ~ 609.6	+25	0	-13	-38	64T ~ 13T	
	609.6 ~ 914.4	+38	0	-13	-51	89T ~ 13T	

1) Fit symbol "L" indicates clearance and "T" indicates interference.

Note: For class 0, bearing outer diameter D applies to 304.8 mm or less.

8. Bearing internal clearance and preload

8.1 Bearing internal clearance

Bearing internal clearance is the amount of internal free movement before mounting. As shown in Fig. 8.1, when either the inner ring or the outer ring is fixed and the other ring is free to move, displacement can take place in either an axial or radial direction. This amount of displacement (radially or axially) is termed the internal clearance and, depending on the direction, is called the radial internal clearance or the axial internal clearance.

When the internal clearance of a bearing is measured, a slight measurement load is applied to the raceway so the internal clearance may be measured accurately. However, at this time, a slight amount of elastic deformation of the bearing occurs under the measurement load, and the clearance measurement value (measured clearance) is slightly larger than the true clearance. This difference between the true bearing clearance and the increased amount due to the elastic deformation must be compensated for. These compensation values are given in Table 8.1. For roller bearings the amount of elastic deformation is small enough to be ignored. The internal clearance values for each bearing class are shown in Tables 8.8 through 8.16.

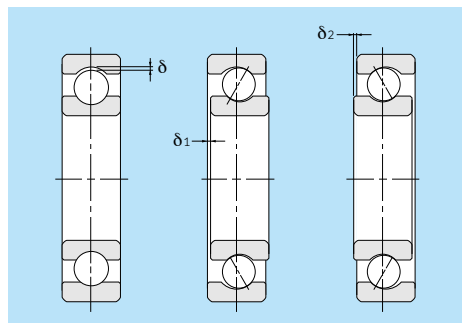

Radial internal clearance = δ
axial internal clearance $\approx \delta_1 + \delta_2$

Fig. 8.1 Internal clearance

8.2 Selection of internal clearance

The internal clearance of a bearing under operating conditions (effective clearance) is usually smaller than the initial clearance before being installed and operated. This is due to several factors including bearing fit, the difference in temperature between the inner and outer rings, etc. As a bearing's operating clearance has an effect on bearing life, heat generation, vibration, noise, etc.; care must be taken in selecting the most suitable operating clearance.

8.2.1 Criteria for selecting bearing internal clearance

A bearing's life is theoretically at its maximum when operating clearance is slightly negative in steady operation. However, in reality it is difficult to constantly maintain this optimal condition. If the negative clearance becomes larger by fluctuating operating conditions, heat will be produced and the life will decrease severely. Under normal circumstances, a study should be performed to select an operating clearance slightly larger than zero. For ordinary operating conditions, use fitting for ordinary loads. If rotational speed and operating temperature are ordinary, selecting normal clearance enables you to obtain the proper operating clearance.

Table 8.2 gives examples applying internal clearances other than CN (normal) clearance.

For the relationship between clearance and life, see the section of "3.8 Clearance and life."

Table 8.1 Adjustment of radial internal clearance based on measured load (deep groove ball bearing) Unit: μm

Nominal bearing bore diameter mm	Measuring Load N	Adjustment of internal clearance	Adjustment of internal clearance				
			C2	CN	C3	C4	C5
10 (included)	18	24.5	3~4	4	4	4	4
18	50	49	4~5	5	6	6	6
50	200	147	6~8	8	9	9	9

Table 8.2 Examples of applications where bearing clearances other than CN (normal) clearance are used

Operating conditions	Applications	Selected clearance
With a heavy or shock load, high fit.	Railway vehicle axles	C3
	Vibration screens	C3, C4
With an indeterminate load, both inner and outer rings are tight fit.	Railway vehicle traction motors	C4
	Tractors and final reduction gear	C4
Shaft or inner ring is heated.	Paper making machines and driers	C3, C4
	Table rollers for rolling mill	C3
Required low noise and vibration when rotating.	Small electric motors	C2, CM
Adjustment of clearance to minimize shaft runout.	Main spindles of lathes (Double-row cylindrical roller bearings)	C9NA, C0NA
Loose fit for both inner and outer rings.	Roll neck of steel mill	C2

8.2.2 Calculation of operating clearance

Operating clearance of a bearing can be calculated from initial bearing internal clearance and considering the decrease in clearance due to fitting and the difference in temperature of the inner and outer rings.

$$\Delta_e = \Delta_0 - (\delta_f + \delta_t) = \Delta_f - \delta_t \dots \dots \dots (8.1)$$

Where:

- Δ_e : Effective internal clearance, mm
- Δ_0 : Bearing internal clearance (initial), mm
- Δ_f : Residual clearance (clearance after preloading), mm
- δ_f : Reduced amount of clearance due to fitting, mm
- δ_t : Reduced amount of clearance due to temperature differential of inner and outer rings, mm

(1) Reduced clearance due to fitting

When bearings are installed with interference fits on shafts and in housings, the inner ring will expand and the outer ring will contract; thus reducing the bearings' internal clearance.

The amount of expansion or contraction varies depending on the shape of the bearing, the shape of the shaft or housing, dimensions of the respective parts, and the type of materials used. The differential can range from approximately 70% to 90% of the effective interference.

$$\delta_f = (0.70 \sim 0.90) \Delta_{d_{eff}} \dots \dots \dots (8.2)$$

δ_f : Reduced amount of clearance due to interference, mm
 $\Delta_{d_{eff}}$: Effective interference, mm

(2) Residual clearance

When the reduced clearance due to interference is calculated using the expansion rate and the contraction rate of each bearing, the residual clearance is calculated by the formula below.

1) Calculation considering distribution
Assume that the initial clearance, bearing inner ring bore diameter, bearing outer diameter outer diameter, bearing outer diameter, and housing bore diameter follow the normal distribution. The residual clearance is generally calculated as the range of percent defective.

When each dimension and clearance follow the normal distribution and the percent defective is 0.26% (standard range = $\pm 3\sigma$), residual clearance Δ_f can be represented by the formula below.

$$\Delta_f = \Delta_{fm} \pm 3\sigma_{\Delta f} \dots \dots \dots (8.3)$$

Where:

- Δ_{fm} : Average value of standard clearance, mm
- $\sigma_{\Delta f}$: Standard deviation of residual clearance

For the average values and standard deviation of residual clearance, see Table 8.3 and Table 8.4.

2) Calculation by direct sum
When the use condition is severe and calculation is to be done under the worst condition, the maximum and minimum values of each dimension are used for direct sum.

$$\left. \begin{aligned} \Delta f_{\max} &= \Delta o_{\max} - \lambda_i \Delta d_{\min} - \lambda_o \Delta D_{\min} \\ \Delta f_{\min} &= \Delta o_{\min} - \lambda_i \Delta d_{\max} - \lambda_o \Delta D_{\max} \end{aligned} \right\} (8.4)$$

Δf_{\max} Δf_{\min} : Maximum and minimum values of residual clearance, mm
 Δo_{\max} Δo_{\min} : Maximum and minimum values of initial clearance, mm
 Δd_{\max} Δd_{\min} : Maximum and minimum values of inner ring interference, mm
 ΔD_{\max} ΔD_{\min} : Maximum and minimum values of outer ring interference, mm
 λ_i λ_o : Inner ring expansion rate, outer ring contraction rate
 (See Table 8.5)

Table 8.3 Average value and standard deviation of residual clearance

Inner ring fit condition	Outer ring fit condition	Δ_{fm} (Average value of residual clearance)	$\sigma_{\Delta f}$ (Standard deviation of residual clearance)
Tight fit	Loose fit	$\Delta_{0m} - \lambda_1 \cdot \Delta_{dm}$	$\sqrt{\sigma_{\Delta 0}^2 + \lambda_1^2 \cdot \sigma_{\Delta d}^2}$
	Tight fit	$\Delta_{0m} - \lambda_1 \cdot \Delta_{dm} - \lambda_o \cdot \Delta_{Dm}$	$\sqrt{\sigma_{\Delta 0}^2 + \lambda_1^2 \cdot \sigma_{\Delta d}^2 + \lambda_o^2 \cdot \sigma_{\Delta D}^2}$
Loose fit	Loose fit	Δ_{0m}	$\sigma_{\Delta 0}$
	Tight fit	$\Delta_{0m} - \lambda_o \cdot \Delta_{Dm}$	$\sqrt{\sigma_{\Delta 0}^2 + \lambda_o^2 \cdot \sigma_{\Delta D}^2}$

Table 8.4 Symbols and formulas used for calculation

		Average value	Standard deviation	Standard range
Shaft diameter	D_s	D_{sm}	$\sigma_{D_s} = \frac{R_{D_s}}{6}$	R_{D_s}
Inner ring bore diameter	d	d_m	$\sigma_d = \frac{R_d}{6}$	R_d
Inner ring interference	Δ_d	$\Delta_{dm} = D_{sm} - d_m$	$\sigma_{\Delta d} = \sqrt{\sigma_{D_s}^2 + \sigma_d^2}$	
Housing bore diameter	d_h	d_{hm}	$\sigma_{d_h} = \frac{R_{d_h}}{6}$	R_{d_h}
Outer ring outer diameter	D	D_m	$\sigma_D = \frac{R_D}{6}$	R_D
Outer ring interference	Δ_D	$\Delta_{Dm} = D_m - d_{hm}$	$\sigma_{\Delta D} = \sqrt{\sigma_D^2 + \sigma_{d_h}^2}$	
Initial clearance	Δ_0	Δ_{0m}	$\sigma_{\Delta 0} = \frac{R_{\Delta 0}}{6}$	$R_{\Delta 0}$
Residual clearance	Δf	Δ_{fm}	$\sigma_{\Delta f}$	
Inner ring expansion rate	λ_1	See Table 8.5		
Outer ring contraction rate	λ_o			

Note: When the linear expansion coefficient difference or the temperature difference of the outer ring and the housing or the inner ring and the shaft are to be considered, it is necessary to first calculate using the bearing inner ring bore diameter, bearing outer ring outer diameter, shaft outer diameter, and housing bore diameter before and after the expansion/contraction and then calculate the expansion rate of the raceway and the effective interference.

Table 8.5 Expansion rate and contraction rate of raceway diameter

Fit condition	Calculation item	Calculation formula	Symbol (Unit: N, mm)
Fit of inner ring and shaft (when the inner ring and the shaft are solid steel)	Inner ring expansion rate	$\lambda_1 = \frac{d}{D_i}$	d : Inner ring bore diameter or shaft diameter d_s : Hollow shaft inner diameter D_i : Inner ring average raceway diameter (refer to Table 8.7)
		$\lambda_1 = \frac{d}{D_i} \cdot \frac{\left\{1 - \left(\frac{d_s}{d}\right)^2\right\}}{1 - \left\{\left(\frac{d}{D_i}\right)^2 \cdot \left(\frac{d_s}{d}\right)^2\right\}}$	
Fit of outer ring and housing (when the outer ring and the housing are solid steel)	Outer ring contraction rate	$\lambda_o = \frac{D_e}{D} \cdot \frac{\left\{1 - \left(\frac{D}{D_h}\right)^2\right\}}{1 - \left\{\left(\frac{D_e}{D}\right)^2 \cdot \left(\frac{D}{D_h}\right)^2\right\}}$	D : Outer ring outer diameter, housing bore diameter D_h : Housing outer diameter D_e : Outer ring average raceway diameter (refer to Table 8.7)
		$\lambda_o = \frac{D_e}{D}$	

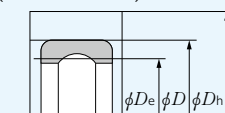
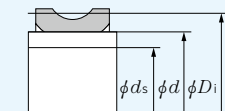
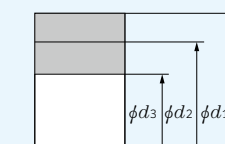

Table 8.6 Fit of two cylinders (general expression)

Calculation item	Calculation formula	Symbol (Unit: N, mm)
Expansion rate of outer cylinder outer diameter	$\lambda_1 = \frac{E_2 \left(\frac{d_1^2 + d_2^2}{(d_1^2 - d_2^2)} + 1 \right)}{E_2 \left\{ \frac{(d_1^2 + d_2^2)}{(d_1^2 - d_2^2)} + \nu_1 \right\} + E_1 \left\{ \frac{(d_2^2 + d_3^2)}{(d_2^2 - d_3^2)} - \nu_2 \right\}} \cdot \frac{d_2}{d_1}$	E_1, E_2 : Longitudinal elastic modulus of outer and inner cylinders ν_1, ν_2 : Poisson's ratio of outer and inner cylinders
Contraction rate of inner cylinder bore diameter	$\lambda_2 = \frac{E_1 \left(\frac{d_2^2 + d_3^2}{(d_2^2 - d_3^2)} + 1 \right)}{E_2 \left\{ \frac{(d_1^2 + d_2^2)}{(d_1^2 - d_2^2)} + \nu_1 \right\} + E_1 \left\{ \frac{(d_2^2 + d_3^2)}{(d_2^2 - d_3^2)} - \nu_2 \right\}} \cdot \frac{d_3}{d_2}$	



Note: Table 13.6 (A-143) in the section of "13. Bearing materials" shows the physical property values of the main materials.

Table 8.7 Average raceway diameter (approximate expression)

Bearing type		Average raceway diameter	
		Inner ring	Outer ring
Ball bearing	All types	1.05 $\frac{4d+D}{5}$	0.95 $\frac{d+4D}{5}$
	12	1.03 $\frac{3d+D}{4}$	0.97 $\frac{d+2D}{3}$
Self-aligning ball bearing	13, 22	1.03 $\frac{3d+D}{4}$	0.97 $\frac{d+3D}{4}$
	23	1.03 $\frac{4d+D}{5}$	0.97 $\frac{d+4D}{5}$
Cylindrical roller bearing ¹⁾	All types	1.05 $\frac{3d+D}{5}$	0.98 $\frac{d+3D}{4}$
Self-aligning roller bearing	Type B, type C, type 213	$\frac{2d+D}{3}$	0.97 $\frac{d+4D}{5}$
	ULTAGE series	$\frac{3d+D}{4}$	0.98 $\frac{d+5D}{6}$
Tapered roller bearing	All types	$\frac{3d+D}{4}$	$\frac{d+3D}{4}$

1) Average raceway diameter values shown for double-flange type.

(3) Reduced internal clearance due to inner/outer ring temperature difference.

During operation, normally the outer ring will range from 5 to 10°C cooler than the inner ring or rotating parts. However, if the cooling effect of the housing is large, the shaft is connected to a heat source, or a heated substance is conducted through the hollow shaft; the temperature difference between the two rings can be even greater. **The amount of internal clearance is thus further reduced** by the differential expansion of the two rings.

$$\delta_t = \alpha \cdot \Delta T \cdot D_o \dots\dots\dots(8.5)$$

δ_t : Reduced amount of clearance due to temperature differential of inner and outer rings, mm

α : Bearing material expansion coefficient
12.5 × 10⁻⁶/°C

ΔT : Inner/outer ring temperature differential, °C

D_o : Outer ring raceway diameter, mm

Outer ring raceway diameter, D_o , values can be approximated by using formula (8.6) or (8.7).

For ball bearings and spherical roller bearings,
 $D_o = 0.20(d + 4.0D) \dots\dots\dots(8.6)$

For roller bearings (except spherical roller bearings),

$$D_o = 0.25(d + 3.0D) \dots\dots\dots(8.7)$$

d : Bearing bore diameter, mm

D : Bearing outside diameter, mm

For the ULTAGE series bearings, consult **NTN Engineering**.

Note that the formula in item 8.2.2 only applies to steel bearings, shafts and housings.

“Operating clearance calculation (based on 3σ)” can be done by using the bearing technique calculation tool on the **NTN** website (<https://www.ntnglobal.com>).

Table 8.8 Radial internal clearance of deep groove ball bearings

Unit: μm

Nominal bearing bore diameter d mm	C2		CN		C3		C4		C5	
	Over	Incl.	Min.	Max.	Min.	Max.	Min.	Max.	Min.	Max.
—	2.5	—	0	6	4	11	10	20	—	—
2.5	6	—	0	7	2	13	8	23	—	—
6	10	—	0	7	2	13	8	23	14	29
10	18	—	0	9	3	18	11	25	18	33
18	24	—	0	10	5	20	13	28	20	36
24	30	—	1	11	5	20	13	28	23	41
30	40	—	1	11	6	20	15	33	28	46
40	50	—	1	11	6	23	18	36	30	51
50	65	—	1	15	8	28	23	43	38	61
65	80	—	1	15	10	30	25	51	46	71
80	100	—	1	18	12	36	30	58	53	84
100	120	—	2	20	15	41	36	66	61	97
120	140	—	2	23	18	48	41	81	71	114
140	160	—	2	23	18	53	46	91	81	130
160	180	—	2	25	20	61	53	102	91	147
180	200	—	2	30	25	71	63	117	107	163
200	225	—	2	35	25	85	75	140	125	195
225	250	—	2	40	30	95	85	160	145	225
250	280	—	2	45	35	105	90	170	155	245
280	315	—	2	55	40	115	100	190	175	270
315	355	—	3	60	45	125	110	210	195	300
355	400	—	3	70	55	145	130	240	225	340
400	450	—	3	80	60	170	150	270	250	380
450	500	—	3	90	70	190	170	300	280	420
500	560	—	10	100	80	210	190	330	310	470
560	630	—	10	110	90	230	210	360	340	520

Table 8.15 Radial internal clearance of spherical roller bearings

Nominal bearing bore diameter <i>d</i> mm		Cylindrical bore bearing									
		C2		CN		C3		C4		C5	
		Over	Incl.	Min.	Max.	Min.	Max.	Min.	Max.	Min.	Max.
14	18	10	20	20	35	35	45	45	60	60	75
18	24	10	20	20	35	35	45	45	60	60	75
24	30	15	25	25	40	40	55	55	75	75	95
30	40	15	30	30	45	45	60	60	80	80	100
40	50	20	35	35	55	55	75	75	100	100	125
50	65	20	40	40	65	65	90	90	120	120	150
65	80	30	50	50	80	80	110	110	145	145	180
80	100	35	60	60	100	100	135	135	180	180	225
100	120	40	75	75	120	120	160	160	210	210	260
120	140	50	95	95	145	145	190	190	240	240	300
140	160	60	110	110	170	170	220	220	280	280	350
160	180	65	120	120	180	180	240	240	310	310	390
180	200	70	130	130	200	200	260	260	340	340	430
200	225	80	140	140	220	220	290	290	380	380	470
225	250	90	150	150	240	240	320	320	420	420	520
250	280	100	170	170	260	260	350	350	460	460	570
280	315	110	190	190	280	280	370	370	500	500	630
315	355	120	200	200	310	310	410	410	550	550	690
355	400	130	220	220	340	340	450	450	600	600	750
400	450	140	240	240	370	370	500	500	660	660	820
450	500	140	260	260	410	410	550	550	720	720	900
500	560	150	280	280	440	440	600	600	780	780	1 000
560	630	170	310	310	480	480	650	650	850	850	1 100
630	710	190	350	350	530	530	700	700	920	920	1 190
710	800	210	390	390	580	580	770	770	1 010	1 010	1 300
800	900	230	430	430	650	650	860	860	1 120	1 120	1 440
900	1 000	260	480	480	710	710	930	930	1 220	1 220	1 570
1 000	1 120	290	530	530	780	780	1 020	1 020	1 330	1 330	1 720
1 120	1 250	320	580	580	860	860	1 120	1 120	1 460	1 460	1 870
1 250	1 400	350	640	640	950	950	1 240	1 240	1 620	1 620	2 080

Unit: μm

Tapered bore bearing										Nominal bearing bore diameter <i>d</i> mm	
C2		CN		C3		C4		C5			
Min.	Max.	Min.	Max.	Min.	Max.	Min.	Max.	Min.	Max.		
—	—	—	—	—	—	—	—	—	—	14	18
15	25	25	35	35	45	45	60	60	75	18	24
20	30	30	40	40	55	55	75	75	95	24	30
25	35	35	50	50	65	65	85	85	105	30	40
30	45	45	60	60	80	80	100	100	130	40	50
40	55	55	75	75	95	95	120	120	160	50	65
50	70	70	95	95	120	120	150	150	200	65	80
55	80	80	110	110	140	140	180	180	230	80	100
65	100	100	135	135	170	170	220	220	280	100	120
80	120	120	160	160	200	200	260	260	330	120	140
90	130	130	180	180	230	230	300	300	380	140	160
100	140	140	200	200	260	260	340	340	430	160	180
110	160	160	220	220	290	290	370	370	470	180	200
120	180	180	250	250	320	320	410	410	520	200	225
140	200	200	270	270	350	350	450	450	570	225	250
150	220	220	300	300	390	390	490	490	620	250	280
170	240	240	330	330	430	430	540	540	680	280	315
190	270	270	360	360	470	470	590	590	740	315	355
210	300	300	400	400	520	520	650	650	820	355	400
230	330	330	440	440	570	570	720	720	910	400	450
260	370	370	490	490	630	630	790	790	1 000	450	500
290	410	410	540	540	680	680	870	870	1 100	500	560
320	460	460	600	600	760	760	980	980	1 230	560	630
350	510	510	670	670	850	850	1 090	1 090	1 360	630	710
390	570	570	750	750	960	960	1 220	1 220	1 500	710	800
440	640	640	840	840	1 070	1 070	1 370	1 370	1 690	800	900
490	710	710	930	930	1 190	1 190	1 520	1 520	1 860	900	1 000
530	770	770	1 030	1 030	1 300	1 300	1 670	1 670	2 050	1 000	1 120
570	830	830	1 120	1 120	1 420	1 420	1 830	1 830	2 250	1 120	1 250
620	910	910	1 230	1 230	1 560	1 560	2 000	2 000	2 470	1 250	1 400

Table 8.16 Axial internal clearance of four points contact ball bearings

Unit: μm

Nominal bearing bore diameter <i>d</i> mm		C2		CN		C3		C4	
		Min.	Max.	Min.	Max.	Min.	Max.	Min.	Max.
17	40	26	66	56	106	96	146	136	186
40	60	36	86	76	126	116	166	156	206
60	80	46	96	86	136	126	176	166	226
80	100	56	106	96	156	136	196	186	246
100	140	66	126	116	176	156	216	206	266
140	180	76	156	136	196	176	236	226	296
180	220	96	176	156	216	196	256	246	316

8.3 Preload

Normally, bearings are used with a slight internal clearance under operating conditions. However, in some applications, bearings are given an initial load; this means that the bearings' internal clearance is negative before operation. This is called "preload" and is commonly applied to angular ball bearings and tapered roller bearings.

8.3.1 Purpose of preload

The following results are obtained by constant elastic compressive force applied to the contact points of rolling elements and raceway by providing preload.

- (1) Bearing's rigidity increases, internal clearance tends not to be produced even

when heavy load is applied.

- (2) The particular frequency of the bearing increases and is **suitable for high-speed rotation**.
- (3) Shaft runoff is suppressed; **rotation and position precision are enhanced**.
- (4) **Vibration and noise are controlled**.
- (5) Sliding of rolling elements by turning, spinning, or pivoting, is controlled and **smearing is reduced**.
- (6) **Fretting** produced by external vibration is **prevented**.

Applying excessive preload could result in reduction of life, abnormal heating, or increase in turning torque. You should therefore consider the objectives before determining the amount of preload.

Table 8.17 Preloading methods and characteristics

Method	Basic pattern	Applicable bearings	Object	Methods and characteristics	Applications
Fixed position preload		Angular contact ball bearing	Maintaining accuracy of rotating shaft, preventing vibration, increasing rigidity	Preloading is accomplished by a predetermined offset of the rings or by using spacers. For the standard preload see Table 8.18 .	Grinding machines Lathes Milling machines Measuring instruments
		Tapered roller bearing Thrust ball bearing Angular contact ball bearing	Increasing bearing rigidity	Preload is accomplished by adjusting a threaded screw. The amount of preload is set by measuring the starting torque or axial displacement.	Lathes Milling machines Differential gears of automobiles Printing machines Wheels
Constant pressure preload		Angular contact ball bearing Deep groove ball bearing Tapered roller bearing (high speed)	Maintaining accuracy and preventing vibration and noise with a constant amount of preload without being affected by loads or temperature	Preloading is accomplished by using coil or Belleville springs. For deep groove ball bearings: 4 to 10 d N d: shaft diameter (mm) For angular contact ball bearings: see Table 8.18 .	Internal grinding machines Electric motors High speed shafts in small machines Tension reels
		Self-aligning roller thrust bearing Cylindrical roller thrust bearing Thrust ball bearing	Preload is primarily used to prevent smearing of opposite axial load side when bearing an axial load.	Preload is accomplished by using coil or Belleville springs. Recommended preloads for thrust ball bearings: (larger value of the formulas below is adopted) $T_1 = 0.42 (n C_{0a})^{1.9} \times 10^{-13} \text{ N}$ $T_2 = 0.00083 C_{0a} \text{ N}$ Self-aligning roller thrust bearing, Cylindrical roller thrust bearing $T = 0.025 C^{0.8} \text{ N}$	Rolling mills Extruding machines

Remarks T : preload, N
 n : Rotational speed min^{-1}
 C_{0a} : Basic static axial load rating, N

8.3.2 Preloading methods and amounts

The most common method of applying preload on a bearing is to change the relative position of the inner and outer rings of the bearing in the axial direction while applying an axial load between bearings on opposing sides. There are two types of preload: fixed position preload and constant pressure preload.

The basic pattern, purpose and characteristics of bearing preloads are shown in **Table 8.17**.

Fixed position preload

- 1) Fixed position preload is effective for positioning the two bearings and also for increasing the rigidity.
- 2) The amount of preload will change due to axial displacement caused by temperature differences between the shaft and housing and the inner and outer rings. Preload will also change as a result of displacement due to loads.

Constant pressure preload

- 1) Due to the use of a spring for the constant pressure preload, the preloading amount can be kept constant, even when the distance between the two bearings fluctuates under the influence of operating heat and load.
- 2) Axial loads cannot be applied in the direction in which springs are contracted.

Also, the standard preloading amount for the paired angular contact ball bearings is shown in **Table 8.18**. Light and normal preload is applied to prevent general vibration, and medium and heavy preload is applied especially when rigidity is required.

8.3.3 Preload and rigidity

The increased rigidity effect preloading has on bearings is shown in **Fig. 8.2** to **Fig. 8.4**. When the offset inner rings of the two paired angular contact ball bearings are pressed together, each inner ring is displaced axially by the amount δ_0 and is thus given a preload, F_0 , in the direction. Under this condition, when external axial load F_a is applied, bearing I will have an increased displacement by the amount δ_a and bearing II will have a decreased displacement. At this time the loads applied to bearing I and II are $F_{I'}$ and $F_{II'}$, respectively. Under the condition of no preload, bearing I will be displaced by the amount δ_b when axial load F_a is applied. Since the amount of displacement, δ_a , is less than δ_b , it indicates a higher rigidity for δ_a .

If a large axial load is to be applied, care must be taken because the preload may be released, causing problems such as heat generation, vibration, and rigidity decrease.

Three-row combinations and two-row combinations are different and have unique right and left displacement diagrams. **Figure 8.3** uses a two-row diagram for bearing I, and **Figure 8.4** uses a two-row diagram for bearing II. When preload F_0 is applied, bearing I is displaced by δ_{01} and bearing II is displaced by δ_{02} . Under this condition, when axial load F_a is additionally applied, bearing I will have an increased displacement by the amount δ_a and bearing II will have a decreased displacement.

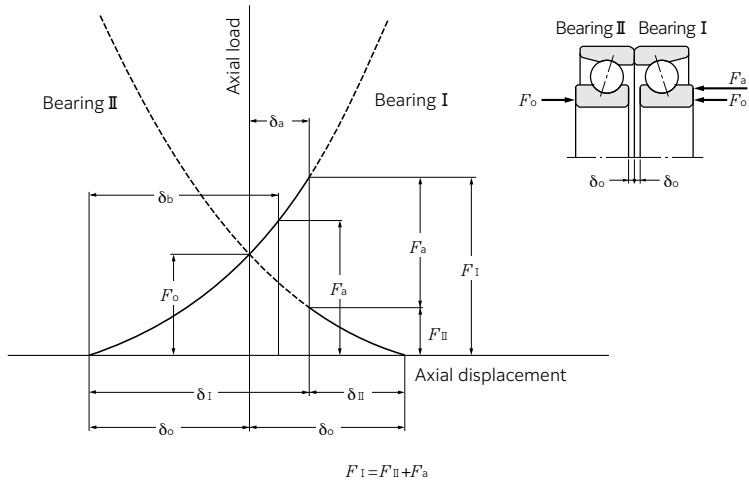
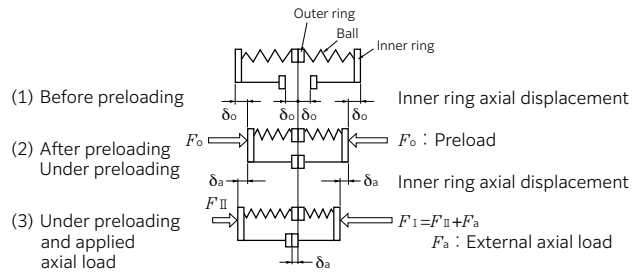

Fig. 8.2 Fixed position preload model diagram and preload diagram

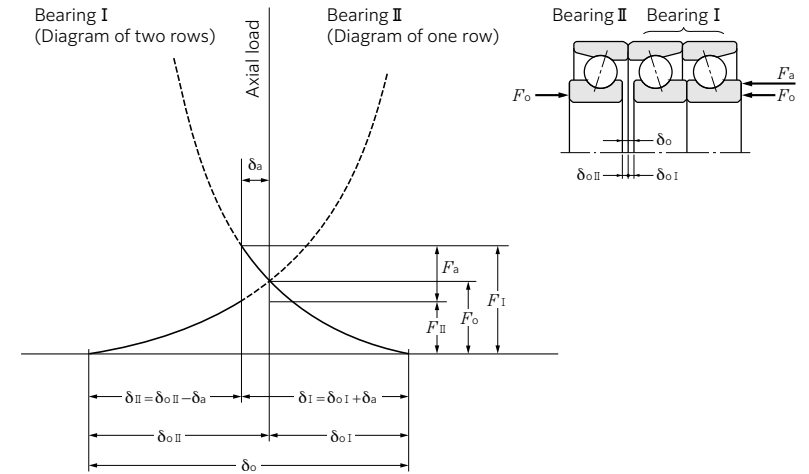

Fig. 8.3 Preload diagram of DBT combination (DT side load)

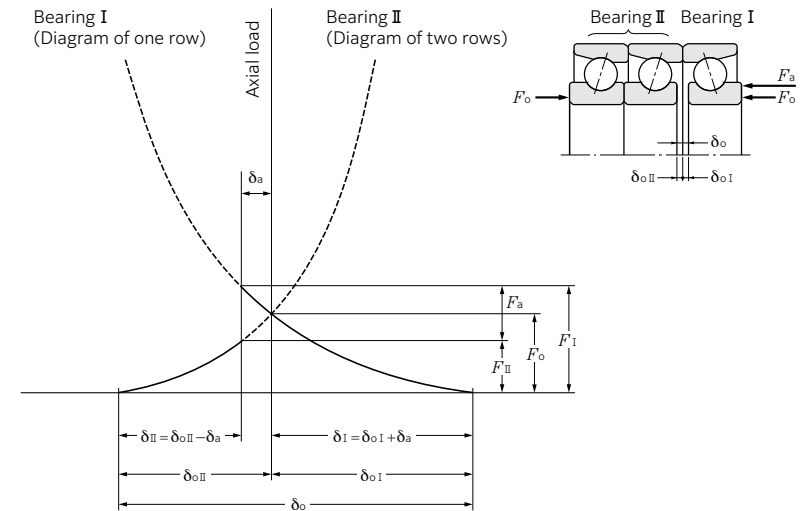

Fig. 8.4 Preload diagram of DBT combination (DB side load)

Table 8.18 The normal preload of duplex angular contact ball bearings

Nominal bearing bore diameter <i>d</i> mm		bearing							
		79				70			
Over	Incl.	Light preload GL	Normal preload GN	Medium preload GM	Heavy preload GH	Light preload GL	Normal preload GN	Medium preload GM	Heavy preload GH
—	12	—	39	78	147	29	78	147	196
12	18	—	49	147	196	29	78	147	294
18	32	29	98	196	294	49	147	294	490
32	40	49	147	294	590	78	294	590	885
40	50	49	196	390	685	78	294	590	980
50	65	78	245	490	785	147	490	880	1 470
65	80	98	390	785	1 180	147	590	1 470	1 960
80	90	147	490	980	1 470	196	885	1 960	2 940
90	95	147	490	980	1 470	196	885	1 960	2 940
95	100	196	685	1 270	1 960	196	885	1 960	2 940
100	105	196	685	1 270	1 960	294	980	2 450	3 900
105	110	196	685	1 270	1 960	294	980	2 450	3 900
110	120	245	885	1 780	2 940	294	980	2 450	3 900
120	140	294	980	1 960	3 450	490	1 470	3 450	5 900
140	150	390	1 270	2 450	4 400	490	1 470	3 450	5 900
150	160	390	1 270	2 450	4 400	685	2 450	4 900	8 850
160	170	390	1 270	2 450	4 400	685	2 450	4 900	8 850
170	180	490	1 770	3 450	5 900	685	2 450	4 900	8 850
180	190	490	1 770	3 450	5 900	885	3 450	6 850	9 800
190	200	685	2 450	4 900	7 850	885	3 450	6 850	9 800

8.4 Necessary minimum load

In general, when a bearing is operated under no load or a very light load, slippage may occur between the rolling element and the raceway (see “8.3.1 Purpose of preload”). In the case of high-speed rotation, a gyro slip or a cage slip may cause early damage such as smearing. In this case it is necessary to apply a minimum load to prevent slippage during bearing operation.

A rough standard for the necessary minimum radial loads for radial bearings is shown below.

- Ball bearings (except self-aligning ball bearings): : 0.023 C_{0r}
 - Self-aligning ball bearings: 0.018 C_{0r}
 - Roller bearings : 0.040 C_{0r}
- Where, C_{0r} : Basic static rating load (N)

* Consult with **NTN** for the necessary minimum axial loads for thrust bearings.

Unit: N

Series		72, 72B				73, 73B			
		Light preload GL	Normal preload GN	Medium preload GM	Heavy preload GH	Light preload GL	Normal preload GN	Medium preload GM	Heavy preload GH
29	98	196	294	49	147	294	390		
29	98	294	390	49	147	390	490		
78	196	490	785	98	294	590	980		
98	390	885	1 470	147	490	980	1 960		
147	590	980	1 960	196	785	1 470	2 450		
196	785	1 470	2 940	294	980	2 450	3 900		
294	980	2 450	3 900	390	1 470	3 450	4 900		
490	1 470	2 940	4 900	590	1 960	3 900	5 900		
490	1 960	3 900	5 900	590	2 450	4 900	6 850		
490	1 960	3 900	5 900	590	2 450	4 900	6 850		
590	2 450	4 900	7 850	685	2 940	5 900	8 850		
590	2 450	4 900	7 850	685	2 940	5 900	8 850		
785	2 940	5 900	9 800	885	3 900	7 850	11 800		
785	2 940	5 900	9 800	885	3 900	7 850	11 800		
885	3 900	7 850	11 800	980	4 400	8 800	13 700		
885	3 900	7 850	11 800	980	4 400	8 800	13 700		
885	3 900	7 850	11 800	980	4 400	8 800	13 700		
980	4 400	8 850	13 700	1 470	5 900	11 800	15 700		
980	4 400	8 850	13 700	1 470	5 900	11 800	15 700		

9. Allowable speed

9.1 Constant speed rotation

As the rotational speed of the bearing increases, the temperature of the bearing also rises due to heat generation inside the bearing due to friction. This may result in damage to the bearing, such as seizure, and the bearing will be unable to continue stable operation. Therefore, the maximum speed at which it is possible for the bearing to continuously operate without the generation of excessive heat beyond specified limits is called the **allowable speed** (min^{-1}). The allowable speed of a bearing depends on the type of bearing, bearing dimensions, type of cage, load, lubrication conditions, and cooling conditions.

The bearing dimensional table gives approximate allowable rotational speeds for grease and oil lubrication.

- The bearing must have the proper internal clearance prescribed in the **NTN Engineering standard design specifications** and must be properly installed.
- A quality lubricant must be used. The lubricant must be replenished and changed when necessary.
- The bearing must be operated at normal operating temperature under ordinary load conditions ($P \leq 0.08 C_r$, $F_a / F_r \leq 0.3$).

If the load is below the minimum necessary load (see section "8. Bearing Internal Clearance and Preload 8.4"), rolling elements may not turn smoothly. If so, please contact **NTN Engineering** for more information. **Allowable rotation for deep groove ball bearings with contact seal (LLU type) or low-torque seal (LLH type) is determined according to the circumferential speed of the seal.** For bearings to be used under heavier than normal load conditions, the allowable speed values listed in the bearing tables must be multiplied by an adjustment factor. The adjustment factors f_L and f_C are given in **Figs. 9.1** and **9.2**.

Also, when radial bearings are mounted on vertical shafts, retention of lubricant and cage guidance are less favorable when compared to horizontal shaft mounting. Therefore, the allowable speed should be reduced to **approximately 80% of the listed speed**. For speeds other than those mentioned above, and for which data is incomplete, please consult **NTN Engineering**.

If rotational speed is to exceed allowable rotational speed given in the dimensions table, it will require special considerations, such as using a bearing for which cage specifications, internal clearance and precision have been thoroughly checked. It may require adopting forced circulation, jet oil or mist oil lubrication as the lubrication method.

Under such high speed operating conditions, when special care is taken, the standard allowable speeds given in the bearing tables can be adjusted upward. The maximum speed adjustment values, f_B , by which the bearing table speeds can be multiplied, are shown in **Table 9.1**. However, for any application requiring speeds in excess of the standard allowable speed, please consult **NTN Engineering**.

Polyube bearings (see section 11.4) have their original allowable rotational speed provision. For details, see the special catalogs "Polyube bearing (CAT. No. 3022/E)" and "Polyube needle bearing (CAT. No. 3605/J)."

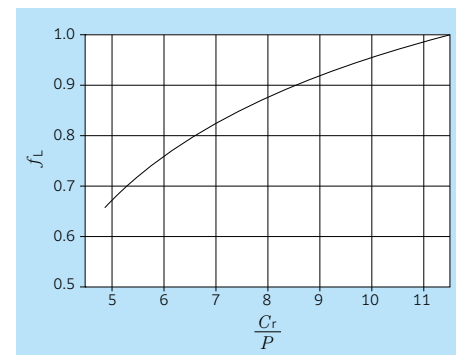

Fig. 9.1 Value of adjustment factor f_L depends on bearing load

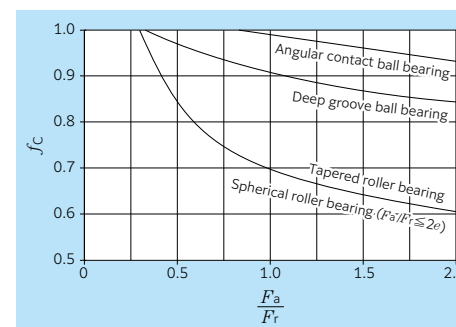

Fig. 9.2 Value of adjustment factor f_C depends on combined load

Table 9.1 Adjustment factor, f_B , for allowable number of revolutions

Bearing type	Adjustment factor f_B
Deep groove ball bearing	3.0
Angular contact ball bearing	2.0
Cylindrical roller bearing	2.5
Tapered roller bearing	2.0

9.2 Low-speed rotation and rapid acceleration/deceleration

When the bearing rotational speed is particularly low (the product of the rotational speed n (min^{-1}) and the rolling element pitch diameter D_{pw} (mm) is $D_{pw} n < 10\,000$), an elastohydrodynamic lubrication oil film may not be formed at the contact surface between the rolling element and the raceway surface.

Under such conditions, lubricant containing an extreme-pressure additive (EP additive) should be used.

When rapid acceleration/deceleration is included in the operating conditions, the cage may break.

Please contact **NTN Engineering** because the allowable rotational speed needs to be examined individually.

9.3 Oscillating applications

In small oscillating movement, the rotation direction changes before the bearing makes one rotation.

The moment when the rotation method forwards and reverses, the rotational speed becomes zero. At this time, a lubrication oil film in the fluid mechanics may not be formed or maintained.

Under such conditions, lubricant containing an extreme-pressure additive (EP additive) should be used.

Suitable preload may be applied to reduce the sliding of rolling elements.

When the oscillation angle is extremely small, an oil film is unlikely to be formed on the contact surface between the raceway surface and the rolling element, and fretting (slight abrasion) may occur.

Please contact **NTN Engineering** because the allowable rotational speed needs to be examined individually.

9.4 Heat rating rotational speed

The heat rating rotational speed is an index standardized in JIS B 1550:2010 (ISO 15312:2003) that uses bearing operating temperature as reference.

This standard refers to the rotational speed of the inner ring of the bearing when the heat generation amount due to the bearing internal friction becomes equivalent to the heat radiation amount of the shaft and housing for mounting the bearing in the case where the bearing is operated at the reference condition below.

Reference conditions are shown below.

- (1) Reference temperature
 - Reference temperature of static outer ring (housing raceway washer): 70°C
 - Reference ambient temperature around bearing: 20°C
- (2) Reference load
 - Radial bearing (0° ≤ α ≤ 45°):
 - Pure radial load of 0.05 × C_{0r}
 - Thrust roller bearing (45° ≤ α ≤ 90°):
 - Pure axial load of 0.02 × C_{0a}
- (3) Lubricant
 - The lubricant must be mineral oil that is free of an extreme-pressure additive and have viscosity ν below the following values at 70°C.
 - Radial bearing:
 - ν = 12 mm²/s (equivalent to ISO VG32)
 - Thrust roller bearing:
 - ν = 24 mm²/s (equivalent to ISO VG68)
- (4) Lubrication method
 - In oil bath lubrication, the oil level is the center of the rolling element that is at the lowermost position.

Refer to JIS B 1550:2010 (ISO 15312:2003) for further details.

10. Friction and temperature rise

10.1 Friction

One of the main functions required of a bearing is that it must have low friction. Under normal operating conditions rolling bearings have a much **smaller friction coefficient** than sliding bearings, especially when comparing **starting friction**.

The friction coefficient for rolling bearings is expressed by formula (10.1).

$$\mu = \frac{2M}{Pd} \dots\dots\dots (10.1)$$

Where:

- μ : Friction coefficient
- M : Friction moment, N · mm
- P : Load, N
- d : Bearing bore, mm

The dynamic friction coefficient for rolling bearings varies with the type of bearing, load, lubrication, speed, and other factors. For normal operating conditions, the approximate friction coefficients for various bearing types are listed in **Table 10.1**.

Table 10.1 Friction coefficient for bearings (reference)

Bearing type	Friction coefficient μ×10 ⁻³
Deep groove ball bearings	1.0~1.5
Angular contact ball bearings	1.2~1.8
Self-aligning ball bearings	0.8~1.2
Cylindrical roller bearings	1.0~1.5
Needle roller bearings	2.0~3.0
Tapered roller bearings	1.7~2.5
Self-aligning roller bearings	2.0~2.5
Thrust ball bearings	1.0~1.5
Thrust roller bearings	2.0~3.0

10.2 Temperature rise

Almost all friction loss in a bearing is transformed into heat within the bearing itself and causes the temperature of the bearing to rise. The amount of thermal generation caused by the friction moment can be calculated using formula (10.2).

$$Q = 0.105 \times 10^{-6} M \times n \dots\dots\dots (10.2)$$

Where:

- Q : Thermal value, kW
- M : Friction moment, N · mm
- n : Rotational speed, min⁻¹

Bearing operating temperature is determined by the equilibrium or balance between the amount of heat generated by the bearing and the amount of heat conducted away from the bearing. In most cases the temperature rises sharply during initial operation, then increases slowly until it reaches a stable condition and then remains constant. The time it takes to reach this steady state depends on the amount of heat produced, heat capacity/diffusion of the shaft and housing, amount of lubricant and method of lubrication. If the temperature continues to rise and does not become constant, it must be assumed that there is some improper function.

When any **abnormal temperature rise** is observed, examine the equipment. Remove the bearing for inspection if necessary. Some possible causes of abnormal temperature rises would be as follows.

- **Bearing misalignment** (due to moment load or incorrect installation)
- **Insufficient internal clearance**
- **Excessive preload**
- **Amount of lubricant too small or large**
- **Unsuitable lubricant**
- **Heat generated from sealing mechanism**
- **Excessive load**
- **Rapid acceleration and deceleration**
- **Heat conducted from external sources**

10.3 Starting torque calculation

The starting torque refers to the torque generated at the time of initial bearing rotation, and the torque generation factor differs between ball bearings and roller bearings. For ball bearings, this calculation is shown below with an angular contact ball bearing. For roller bearings, a tapered roller bearing is used as an example.

Even if the actual starting torque value is the same number, the torque calculation value is a reference value because there is measurement variation for each bearing.

1) Preload and starting torque of angular contact ball bearings

Bearings having a contact angle such as angular contact ball bearings and tapered roller bearings cannot be used by themselves. Two bearings must face each other or be used in combination. In this case, the bearings are often used by applying a preload, and the larger the preload is, the larger the friction torque of the bearing becomes. The starting torque of the angular contact ball bearing when a preload is applied generates the majority of the spin slip and the rolling friction torque.

The relationship between the preload and the starting torque of angular contact ball bearings is not a simple proportional relationship, and the calculation is complicated; therefore, please contact NTN Engineering.

2) Preload and starting torque of tapered roller bearings

The starting torque of tapered roller bearings are influenced by the following factors.

- (1) Sliding friction between roller large end surface and inner ring large rib surface
- (2) Rolling friction of rolling surface
- (3) Sliding friction of roller and cage

- (4) Stirring resistance of lubricant
- However, (2) to (4) are extremely small compared with (1); therefore, the starting torque of tapered roller bearings is calculated by (1).

Starting torque M of tapered roller bearings is represented by formula (10.3).

$$M = \mu \cdot e \cdot \cos(\beta/2) \cdot F_a \quad \text{N} \cdot \text{mm} \quad \dots(10.3)$$

- M : Starting torque, N · mm
- μ : Friction coefficient
- e : Contact position between roller and inner ring rib, mm (see Figure 10.1)
- β : Roller angle, ° (see Figure 10.1)
- F_a : Preload, N

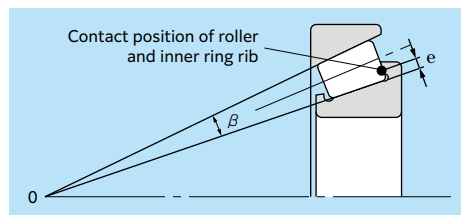

Figure 10.1 β and e

Figure 10.2 shows calculation examples. For details, please contact NTN Engineering.

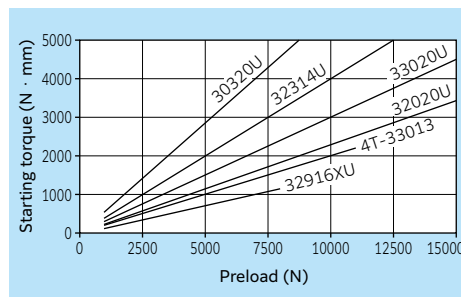

Figure 10.2 Preload and starting torque of tapered roller bearings

11. Lubrication

11.1 Purpose of lubrication

The purpose of rolling bearing lubrication is to prevent direct metallic contact between the various rolling and sliding elements. This is accomplished through the formation of a thin oil (or grease) film on the contact surfaces. Lubricant is necessary for operating rolling bearings. For rolling bearings, lubrication has the following advantages:

- (1) **Reduction of friction and wear**
It prevents direct metallic contact between the rolling and sliding elements of bearing components and reduces friction and wear.
- (2) **Prolonged bearing life**
The rolling fatigue life is prolonged by forming an oil film on the rolling contact surface part.
- (3) **Friction heat dissipation** and cooling
circulating lubrication can dissipate heat generated from friction or conducted from the outside.
- (4) **Others**
It prevents foreign materials from entering inside the bearing and suppresses corrosion (rust) by covering the bearing surface with oil.

In order to exhibit these effects, a lubrication method that matches service conditions is required. In addition to this, a quality lubricant must be selected, the proper amount of lubricant must be used and the bearing must be designed to prevent foreign matter from getting in or lubricant from leaking out. If lubrication is insufficient, friction is not reduced, causing excessive rise in bearing temperature or abnormal wear. Therefore, an appropriate lubrication and lubrication method should be selected.

Fig. 11.1 shows the relationship between oil volume, friction loss, and temperature rise. Table 11.1 details the characteristics of this relationship.

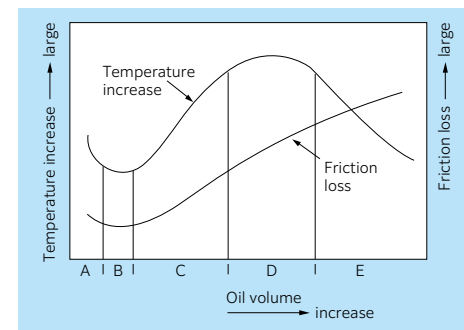

Fig. 11.1

Table 11.1 Oil volume, friction loss, and temperature increase (See Fig. 11.1)

Range	Characteristics	Lubrication method
A	When oil volume is extremely low, direct metallic contact occurs in places between the rolling elements and raceway surfaces. Bearing abrasion and seizing may occur.	—
B	A thin oil film develops over all surfaces, friction is minimal and bearing temperature is low.	Grease lubrication Oil mist Air-oil lubrication
C	As oil volume increases, heat buildup is balanced by cooling.	Circulating lubrication
D	Regardless of oil volume, temperature increases at a fixed rate.	Circulating lubrication
E	As oil volume increases, cooling dominates and bearing temperature decreases.	Forced circulation lubrication Oil jet lubrication

11.2 Lubrication methods and characteristics

Lubrication methods for bearings can be roughly divided into **grease** and **oil lubrication**. Each of these has its own features, so the lubrication method that best offers the required function must be selected.

Characteristics of each method are shown in **Table 11.2**.

Table 11.2 Comparison of grease lubrication and oil lubrication characteristics

Concern	Method	Grease lubrication	Oil lubrication
Handling		◎	△
Reliability		○	◎
Cooling effect		×	○ (Circulation necessary)
Seal structure		○	△
Power loss		○	○
Environment contamination		○	△
High speed rotation		×	○

◎ : Very good ○ : Good △ : Fair × : Poor

11.3 Grease lubrication

Grease lubricants are relatively easy to handle and require only the simplest sealing devices. For these reasons, grease is the most widely used lubricant for rolling bearings. It is used in a bearing that is pre-sealed with grease (sealed/shielded bearing), or if using an unsealed bearing, fill the bearing and housing with the proper amount of grease, and replenish or change the grease regularly.

With sealed bearings, the proper grease amount does not cause leakage; however, under use conditions including a lot of vibrations, which cause grease to flow easily, or under high-speed outer ring rotation, in which large centrifugal force is applied on the grease, the grease may purge (in rare cases). Please consult NTN Engineering.

11.3.1 Types and characteristics of grease

Lubricating grease is composed of either a mineral base oil or a synthetic base oil. **To this base a thickener and other additives are added.** The properties of all greases are mainly determined by the kind of base oil used and by the combination of thickening agent and various additives. **Table 11.5** shows general grease varieties and characteristics, and **Table 11.6** shows grease brand names and their characteristics. (See pages A-116 and A-117.) As performance characteristics of even the same type of grease will vary widely from brand to brand, **it is necessary to check the manufacturers' data when selecting grease.**

(1) Base oil
Mineral oil or synthetics such as **ester oil, synthetic hydrocarbon oil**, or **ether oil** are used as the base of greases.

Generally, greases with low viscosity base oils are best suited for low temperatures and high speeds; grease using high-viscosity base oil has superior high-temperature and high-load characteristics.

(2) Thickening agents
 Thickening agents are compounded with base oils to maintain the semi-solid state of the grease. Thickening agents consist of two types of bases: metallic soaps and non-soaps. Metallic soap thickeners include: **lithium, sodium, calcium**, etc. Non-soap base thickeners are divided into two groups: inorganic (**silica gel, bentonite**, etc.) and organic (**polyurea, fluorocarbon**, etc.). The various special characteristics of a grease, such as **limiting temperature range, mechanical stability**, water resistance, etc. depend largely on the type of **thickening agent** used. For example, a sodium based grease is generally poor in water resistance properties, while greases with bentone, poly-urea and other non-metallic soaps as

the thickening agent are generally superior in high temperature properties.
 (3) Additives
 Various additives are added to grease depending on the purpose. Typical additives include **anti-oxidants, high-pressure additives** (EP additives), **rust preventives**, and **anti-corrosives**. For bearings subject to heavy loads and/or shock loads, grease containing high-pressure additives should be used. Anti-oxidants are added to grease used in most types of rolling bearings.

(4) Consistency
 Consistency is an index that indicates hardness and fluidity of grease. **The higher the NLGI number, the HARDER the grease is.** For the lubrication of rolling bearings, greases with the NLGI consistency numbers of 1, 2, and 3 are used. General relationships between consistency and application of grease are shown in **Table 11.3**.

Table 11.3 Consistency of grease

NLGI consistency No.	JIS(ASTM) 60 times blend consistency	Application
0	355 to 385	For centralized greasing use
1	310 to 340	For centralized greasing use
2	265 to 295	For general use and sealed bearing use
3	220 to 250	For general use, high temperature use, and sealed bearing use
4	175 to 205	For special use

(5) Mixing different types of greases
 When greases of different kinds are mixed together, the consistency of the greases will change (usually softer), the operating temperature range will be lowered, and other changes in characteristics will occur. **As a rule, grease should not be mixed with grease of any other brand.** However, if different greases must be mixed, at least greases with the same base oil and thickening agent should be selected.

11.3.2 Amount of grease

The amount of grease used in any given situation will depend on many factors relating to the size and shape of the housing, space limitations, bearing's rotating speed and type of grease used. As a rule of thumb, **bearings should be filled to 30 to 40% of their space and housing should be filled 30 to 60%**. Where speeds are high and temperature rises need to be kept to a minimum, a reduced amount of grease should be used. Excessive amounts of grease cause temperature rises which in turn cause the grease to soften and may allow leakage. Oxidation and deterioration of excessive grease fills may cause the lubricating efficiency to be lowered. Moreover, the standard bearing space can be found by formula (11.1)

$$V = K \cdot W \dots\dots\dots (11.1)$$

where,

V : Quantity of bearing space open type (approx.), cm³

K : Bearing space factor (see value of K in **Table 11.4**)

W : Mass of bearing, kg

A predetermine amount of grease is filled in the bearing with a grease gun or a syringe. After sealing it is not possible to spread the grease by hand - only by rotating the bearing by hand.

Table 11.4 Bearing space factor K

Bearing type ¹⁾		Cage type	K	
Deep groove ball bearing ²⁾		Pressed cage	61	
Angular contact ball bearing		Pressed cage	54	
		Machined cage	33	
		Molded resin cage	33	
Cylindrical roller bearing	NU type ³⁾	Pressed cage	50	
		Machined cage	36	
	N type ⁵⁾	Pressed cage	55	
		Machined cage	37	
	ULTAGE series(EA type) E type	NU type ⁴⁾	Machined cage	33
			Molded resin cage	33
		N type ⁴⁾	Machined cage	34
			Molded resin cage	35
Tapered roller bearing		Pressed cage	46	
Spherical roller bearing	Type C		Pressed cage	35
	Type B Type 213		Machined cage	28
	ULTAGE series	Type EA	Pressed cage	33
		Type EM	Machined cage	31

1) Does not apply to model numbers that are not specified in the catalog.
 2) Does not apply top 160 series bearings. 3) Does not apply to NU4 series.
 4) Applies to G1 machined cages only. 5) Does not apply to N4 series.

Table 11.5 Grease varieties and characteristics ¹⁾

	Soap-based				
	Lithium (Li) grease			Calcium (Ca) grease	
Thickening agent ²⁾	Li soap			Li complexed soap	Ca soap (cup grease)
Base oil ³⁾	Mineral oil	Ester oil	Silicone oil	Mineral oil	Mineral oil
Dropping point °C	170 to 190	170 to 190	200 to 210	>250	80 to 100
Operating temperature range °C	-30 to 120	-50 to 130	-50 to 160	-30 to 130	-20 to 70
Mechanical stability	Good	Good	Good	Good	OK
Pressure resistance	Good	Good	Poor	Good	OK
Water resistance	Good	Good	Good	Good	Good
Characteristics/ application	Balanced performance with less disadvantages	Excellent low temperature and wear characteristics	Excellent characteristics at low and high temperatures	Balanced performance with less disadvantages	Used for low speed and light loads
	All purpose grease	Suitable for small sized and miniature bearings	Poor load resistance	Usable for relatively high temperature	Unusable for high temperature

- 1) Use the grease performance as rough standards because it differs depending on the manufacturer's additive formation.
 2) Na soap-based grease may be emulsified by water and high humidity conditions.
 Urea-based grease may deteriorate polyfluorocarbons and rubber.

Table 11.6 Grease brands and their nature

Brand	Code	Thickener	Base oil	Base oil viscosity mm ² /s	
				40°C	100°C
Alvania Grease S2	2AS	Li soap	Mineral oil	131	12.2
Alvania Grease S3	3AS	Li soap	Mineral oil	131	12.2
Alvania EP Grease 2	8A	Li soap	Mineral oil	220	15.9
Multemp PS No. 2	1K	Li soap	Ester + PAO	15.9	—
Multemp SRL	5K	Li soap	Ester	24.1	—
SH33L	3L	Li soap	Silicone	70	27
SH44M	4M	Li soap	Silicone	80	19
ISOFLEX NBU15	15K	Ba complexed soap	Diester + mineral oil	23	5
SHC POLYREX 462	L791	Urea	PAO	460	40
SE-1	L749	Urea	PAO + ester	22	5
ME-1	L700	Urea	Ester + PAO	61.3	9.3
EP-1	L542	Urea	PAO	46.8	—
NA103A	L756	Urea	PAO + ether	53.5	—
MP-1	L448	Urea	Synthetic oil	40.6	7.1
Grease J	L353	Urea	Ester	75	10
Cosmo Wide Grease WR3	2M	Na terephthalate	Diester + mineral oil	31.6	6
Mobilgrease 28	9B	Bentonite	PAO	30	5.7
Aeroshell Grease 7	5S	Microgel	Diester	10.3	3.1

- Note: 1. Representative values are shown for the base oil viscosity, consistency, and dropping point.
 2. The upper and lower limits of the operating temperature range differ depending on the usage environment and requirement specifications. Please consult with NTN Engineering.

Soap-based		Non-soap-based			
Calcium (Ca) grease	Sodium (Na) grease	Organic			Inorganic
Ca complexed soap	Na soap	Urea	Urea	PTFE	Silica gel
Mineral oil	Mineral oil	Mineral oil	Synthetic oil	Fluorinated	Ester oil
200 to 280	170 to 200	>260	>260	None	>260
-20 to 130	-20 to 130	-30 to 140	-40 to 180	-40 to 250	-70 to 150
Good	Good	Good to Excellent	Good to Excellent	OK to Good	Good
Good to Excellent	Good	Good to Excellent	Good to Excellent	Good	Good
Good	Poor	Good to Excellent	Good to Excellent	Good	Good
Excellent pressure resistance	Some emulsification when water is introduced Usable for relatively high temperature	Excellent water resistance and oxidation stability	Excellent water resistance and oxidation stability Used for high temperature and high speed applications	Excellent chemical resistance Used for high temperature applications	Excellent characteristics at low temperature

- 3) Ester oil-based grease may swell acrylic materials, and silicone-based grease may swell silicone materials.
 Some silicone-based greases and fluorine-based greases have poor noise performance and rustproofing performance.

60 times blend consistency		Dropping point °C	Operating temperature range °C	Characteristics
Representative value	NLGI No			
283	2	181	-25 to 120	All-purpose (standard grease for deep grease ball bearings)
242	3	182	-20 to 135	All-purpose (standard grease for ball bearings of bearing units)
284	2	184	-20 to 110	All-purpose for high loads
270	2	190	-50 to 130	For low temperature and low torque
250	2 to 3	192	-40 to 150	For low temperature to high temperature, all-purpose (standard grease for miniature/small diameter ball bearings)
320	1 to 2	220	-70 to 140	For low temperature
260	2 to 3	204	-40 to 160	For high temperature
280	2	220 or above	-40 to 130	For high speed
280	2	270	-20 to 170	For food machinery
265	2	220 or above	-50 to 120	For high speed
231	3	250 or above	-30 to 160	For high temperature and high speed
220	2	260 or above	-40 to 160	For high temperature and high speed
270	2	260 or above	-40 to 180	Brittle separation
243	3	250 or above	-40 to 150	For high temperature and high speed
305	1 to 2	280 or above	-20 to 180	For high temperature
238	3	230 or above	-40 to 150	For low temperature to high temperature, all-purpose
293	1 to 2	307	-54 to 177	MIL-PRF-81322 For low temperature to high temperature
296	1 to 2	260 or above	-73 to 149	MIL-PRF-23827C

11.3.3 Grease replenishment

As the lubricating performance of grease declines with the time, grease must be filled in proper intervals.

The replenishment interval depends on the type of bearing, dimensions, bearing's rotating speed, bearing temperature, and type of grease. An easy reference chart for calculating grease replenishment interval is shown in Fig. 11.2. This chart indicates the replenishment interval

for standard rolling bearing grease when used under normal operating conditions. As operating temperatures increase, the grease interval should be shortened accordingly. Generally, for every 10°C increase in bearing temperature above 80°C, the grease interval period is shortened to "2/3".

For grease replenishment interval of the ULTAGE series, please contact NTN Engineering.

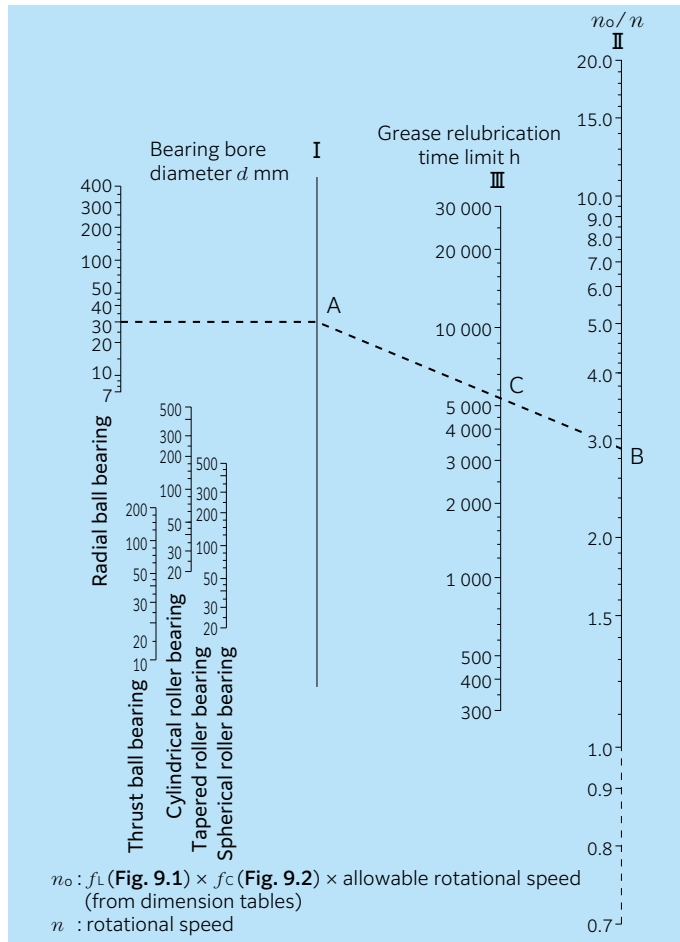

Fig. 11.2 Diagram for grease interval

(Example) Find the grease relubrication time limit for deep groove ball bearing 6206, with a radial load of 2.0 kN operating at 3 600 min⁻¹

From Fig. 9.1 $C_r / P_r = 21.6 / 2.0 \text{ kN} = 10.8$, $f_L = 0.96$. Allowable rotational speed from the dimensions tables for bearing 6206 is 11 000 min⁻¹. Allowable rotational speed n_0 for 2.0 kN radial load is:

$$n_0 = 0.96 \times 11\,000 = 10\,560 \text{ min}^{-1}$$

$$\text{Therefore, } \frac{n_0}{n} = \frac{10\,560}{3\,600} = 2.93$$

The point where vertical line I intersects a horizontal line drawn from the point equivalent of $d = 30$ for the radial ball bearing shown in Fig. 11.2 shall be point A. Find intersection point C where vertical line III intersects the straight line formed by joining point B ($n_0/n = 2.93$) with A by a straight line II. It shows that grease life in this case is approximately 5,500 hours.

11.3.4 Grease life estimation of sealed ball bearings

There is a method of estimating the grease life of single row sealed and greased ball bearings.

The estimated grease life changes depending on the grease type, temperature, shaft rotational speed, and load; therefore, please contact NTN Engineering for details.

11.4 Solid grease

"Solid grease" is a lubricant composed mainly of lubricating grease and ultra-high polymer polyethylene. Solid grease begins as grease that has the same viscosity as a more traditional grease. After being heated and cooled, a process known as a "calcination", the grease hardens while maintaining a large quantity of lubricant within the polymer structure. The result of this solidification is that the grease does not easily leak from the bearing, even when the bearing is subjected to strong vibrations or centrifugal force.

Bearings with solid grease are available in two types: the spot-pack type in which solid grease is injected into the cage, and the full-pack type in which all free space around the rolling elements is completely filled with solid grease.

Spot-pack solid grease is available for deep groove ball bearings, small diameter ball bearings, and bearing units. Full-pack solid grease is available for self-aligning ball bearings, spherical roller bearings, and needle roller bearings.

Primary advantages:

- (1) Minimal grease leakage
- (2) Low bearing torque with spot-pack type solid grease

For more details, please refer to the special catalog "Bearings with solid grease (CAT. No. 3022/E)."

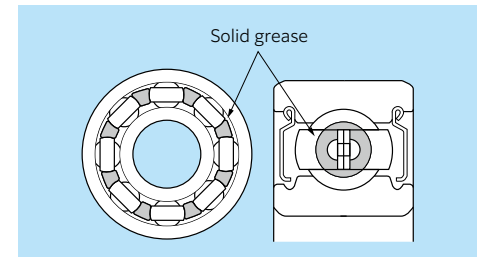

Fig. 11.3 Deep groove ball bearing with spot-pack solid grease (Z shield) (Available for deep groove ball bearings)

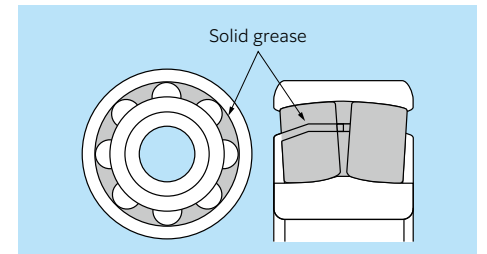

Fig. 11.4 Spherical roller bearing with full-pack solid grease (Available for spherical roller bearings)

11.5. Oil lubrication

Oil lubrication is suitable for applications requiring that bearing-generated heat or heat applied to the bearing from other sources be

carried away from the bearing and dissipated to the outside.

Table 11.7 shows the main methods of oil lubrication.

Table 11.7 Oil lubrication methods

Lubrication method	Example	Lubrication method	Example
<p>(Oil bath lubrication)</p> <ul style="list-style-type: none"> Oil bath lubrication is the most generally used method of lubrication, and is widely used for low to moderate rotational speed applications. For horizontal shaft applications, oil level should be maintained at approximately the center of the lowest rolling element, according to the oil gauge, when the bearing is at rest. For vertical shafts at low speeds, oil level should be maintained at 50 - 80% submergence of the rolling elements. 		<p>(Disc lubrication)</p> <ul style="list-style-type: none"> In this method, a partially submerged disc rotates and pulls oil up into a reservoir from which it then drains down through the bearing, lubricating it. 	
<p>(Oil spray lubrication)</p> <ul style="list-style-type: none"> In this method, an impeller or similar device mounted on the shaft draws up oil and sprays it onto the bearing. This method can be used at considerably high speeds. 		<p>(Oil mist lubrication)</p> <ul style="list-style-type: none"> Using pressurized air, lubricating oil is atomized before passing through the bearing. Due to the low lubricant resistance, this method is well suited to high speed applications. 	
<p>(Drip lubrication)</p> <ul style="list-style-type: none"> In this method, oil is collected above the bearing and allowed to drip down into the housing where it becomes a lubricating mist as it strikes the rolling elements. Another version allows only slight amounts of oil to pass through the bearing. Used at relatively high speeds for light to moderate load applications. In most cases, oil volume is a few drops per minute. 		<p>(Air-oil lubrication)</p> <ul style="list-style-type: none"> In this method, the required minimum amount of lubricating oil is measured and fed to each bearing at ideal intervals using compressed air. Fresh lubricating oil is constantly fed. Because the required oil quantity is very small, the working environment can be kept clean. 	
<p>(Circulating lubrication)</p> <ul style="list-style-type: none"> Used for bearing cooling or for automatic oil supply systems in which the oil supply is centrally located. One of the advantages of this method is that oil cooling devices and filters to maintain oil purity can be installed within the system. In order for oil to thoroughly lubricate the bearing, oil inlets and outlets must be provided on opposite sides of the bearing. 		<p>(Oil jet lubrication)</p> <ul style="list-style-type: none"> This method lubricates by injecting oil under high pressure directly into the side of the bearing. This is a reliable system for high speed, high temperature or otherwise severe conditions. Used for lubricating the bearings in jet engines, gas turbines, and other high speed equipment. Under-race lubrication is one example of this type of lubrication. 	

11.5.1 Selection of lubricating oil

Under normal operating conditions, machine oil, turbine oil, and other mineral oils are widely used for the lubrication of rolling bearings.

However, for temperatures below -30°C or above 150°C, synthetic oils such as ester oil, silicone oil, and fluorinated oil are used.

For lubricating oils, viscosity is one of the most important properties and determines an oil's lubricating efficiency. If viscosity is too low, formation of the oil film will be insufficient, and damage to the rolling surface will occur.

If viscosity is too high, viscous resistance will also be great, resulting in temperature increase and friction loss. In general, for higher speed applications, a lower viscosity oil should be used; for heavier load applications, a higher viscosity oil should be used.

Lubrication of rolling bearings requires viscosity shown in Table 11.8, which is dependent on the use conditions. Fig 11.5 shows the relation between lubricating oil viscosity and temperature. This is used to select a lubrication oil with viscosity characteristics appropriate for the operating temperature.

For reference, Table 11.9 lists the selection standards for lubricating oil viscosity based on bearing operating conditions.

Table 11.8 Required lubricating oil viscosity for bearings

Bearing type	Dynamic viscosity mm ² /s
Ball bearings, Cylindrical roller bearings, Needle roller bearings	13 or above
Spherical roller bearings, Tapered roller bearings, Needle roller thrust bearings	20 or above
Self-aligning roller thrust bearing	30 or above

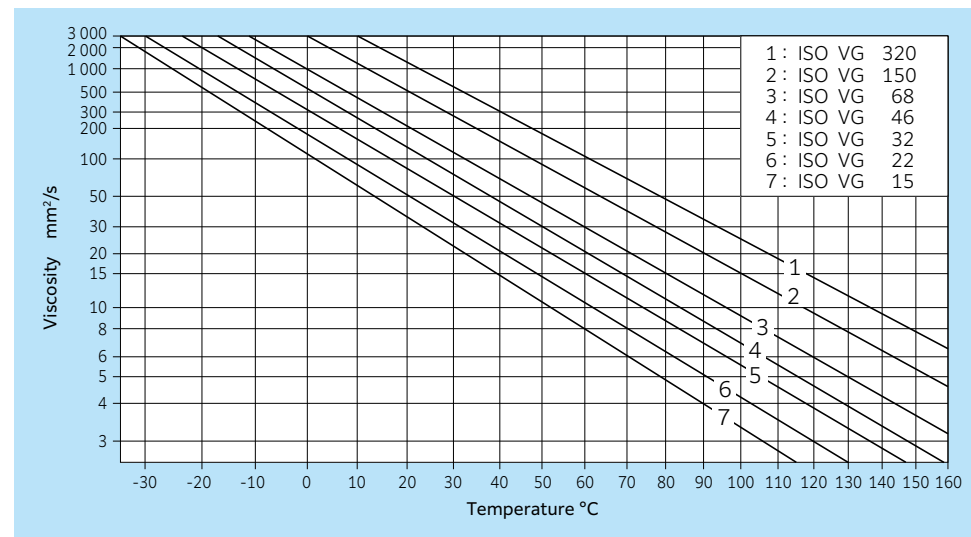

Fig 11.5 Relation between lubricating oil viscosity and temperature

Table 11.9 Standards for lubricating oil viscosity

Bearing operating temperature °C	dn value ¹⁾	Lubricating oil ISO viscosity grade (VG)		Suitable bearing
		Normal load	Heavy load or shock load	
-30 to 0	Up to allowable rotational speed	22, 32	46	All types
0 to 60	Up to 15 000	46, 68	100	All types
	15 000 to 80 000	32, 46	68	All types
	80 000 to 150 000	22, 32	32	All types but thrust ball bearings
	150 000 to 500 000	10	22, 32	Single row radial ball bearings, cylindrical roller bearings
60 to 100	Up to 15 000	150	220	All types
	15 000 to 80 000	100	150	All types
	80 000 to 150 000	68	100, 150	All types but thrust ball bearings
	150 000 to 500 000	32	68	Single row radial ball bearings, cylindrical roller bearings
100 to 150	Up to allowable rotational speed	320		All types
0 to 60	Up to allowable rotational speed	46, 68		Self-aligning roller bearing
60 to 100	Up to allowable rotational speed	150		

1) dn value: [dn = bearing bore diameter d (mm) × rotational speed n (mm⁻¹)]
 Note: 1. Applied when lubrication method is either oil bath or circulating lubrication.
 2. Please consult NTN Engineering in cases where operating conditions fall outside the range covered by this table.

11.5.2 Oiling amount

When a bearing is to be supplied with oil forcibly, the amount of heat generated from the bearing is equal to the sum of the amount of heat dissipated from the housing and the amount of heat carried away by the oil.

The oiling amount that serves as a rough indication when a standard housing is used can be obtained by formula (11.2).

$$Q = K \cdot q \dots\dots\dots(11.2)$$

where,

Q: oiling amount per bearing (cm³/min)

K: coefficient determined by allowable temperature rise of oil (Table 11.10)

q: oiling amount obtained by diagram (cm³/min) (Fig. 11.6)

The heat dissipation amount differs depending on the housing type. Therefore, in the actual operation, it is desirable to obtain the oiling amount suitable for the actual machine by adjusting the amount obtained by formula (11.2) to 1.5 to 2 times.

In addition, when calculating the oiling amount assuming that no heat is dissipated from the housing and the generated heat

amount is completely carried away by the oil, use the shaft diameter in the diagram as d = 0.

Table 11.10 Value of K

Expelled oil temp minus supplied oil temp °C	K
10	1.5
15	1
20	0.75
25	0.6

(Example) For tapered roller bearing 30220U mounted on a flywheel shaft with a radial load of 9.5 kN, operating at 1 800 min⁻¹, what is the amount of lubricating oil Q required to keep the bearing temperature rise below 15°C?

d = 100mm,
 dn = 100 × 1 800 = 18 × 10⁴
 From Fig. 11.6 q = 180cm³/min
 Assume the bearing temperature is approximately equal to the expelled oil temperature,
 from Table 11.10, since K = 1
 Q = K × q = 1 × 180 = 180cm³/min

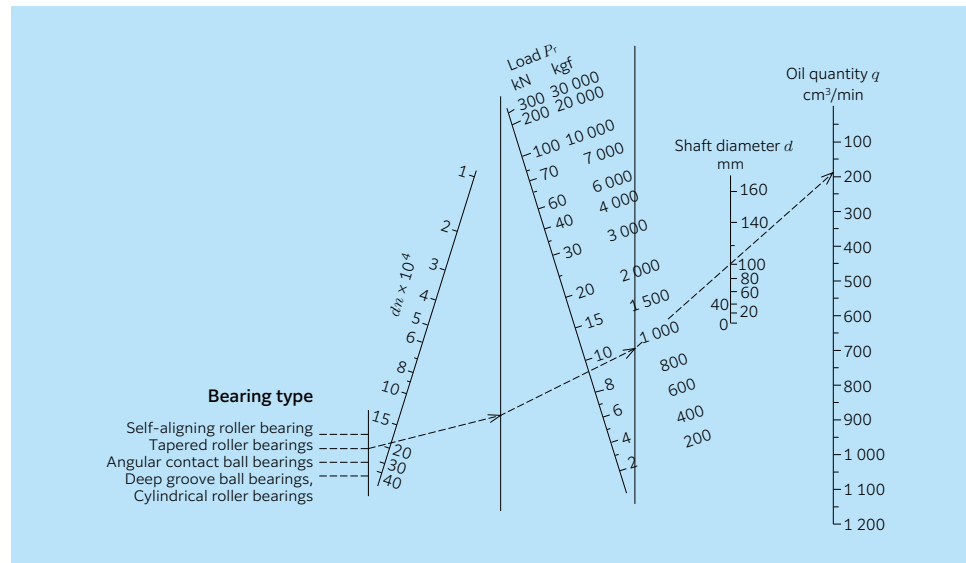

Fig. 11.6 Oil quantity guidelines

11.5.3 Relubrication intervals

The intervals at which lubricating oil should be changed varies depending upon operating conditions, oil quantity, and type of oil used. In general, for oil bath lubrication where the operating temperature is 50°C or less, oil should be replaced once a year. When the operating temperature is between 80°C - 100°C, oil should be replaced at least once every three months. For important equipment, it is advisable that lubricating efficiency and oil purity deterioration be checked regularly to determine when oil replacement is necessary.

12. External bearing sealing devices

External seals have two main functions: to prevent lubricating oil from leaking out of the bearing, and to prevent dust, water, and other contaminants from entering inside the bearing. When selecting a seal, the following factors should be considered, in addition to the application's operating conditions: Type of lubricant (oil or grease), seal lip speed, shaft misalignment, space limitations, seal friction and heat generation, and cost.

Sealing devices for rolling bearings fall into two main classifications: non-contact seals and contact seals.

● **Non-contact seals:** Non-contact seals utilize a small clearance between the shaft and the housing, or between the shaft and sealing apparatus. Therefore friction is negligible, making them suitable for high speed applications.

In order to improve sealing capability, the gaps between the shaft and sealing apparatus are often filled with lubricant.

● **Contact seals:** A contact seal is a seal in which a molded synthetic rubber lip on a steel plate is pressed against the shaft. Contact seals are generally far superior to non-contact seals in sealing effectiveness, although their friction torque and temperature rise coefficients are higher. Furthermore, because the lip portion of a contact seal slides while in contact with the shaft, the allowable lip speed may vary based on the seal design.

The surface at which the seal lip contacts the shaft must be lubricated. Ordinary bearing lubricant can also be used for this purpose.

Table 12.1 lists the special characteristics of seals and other points to be considered when choosing an appropriate seal.

Table 12.1 Seal characteristics and selection considerations

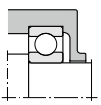
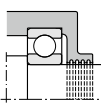
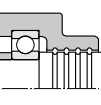
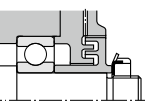
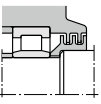
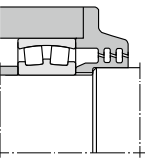
Type	Seal construction	Designation	Seal characteristics and selection considerations									
Non-contact seals		Clearance seal	This is a simple seal design with a small radial clearance between the shaft and housing.	<p>Cautionary points regarding selection</p> <ul style="list-style-type: none"> In order to improve sealing effectiveness, clearances between the shaft and housing should be minimized. However, care should be taken to confirm shaft/bearing rigidity and other factors to avoid direct contact between the shaft and housing during operation. <table border="1"> <thead> <tr> <th colspan="2">Oil groove clearance (approx.)</th> </tr> <tr> <th>Shaft diameter mm</th> <th>Clearance mm</th> </tr> </thead> <tbody> <tr> <td>Up to 50</td> <td>0.2~0.4</td> </tr> <tr> <td>50 or larger</td> <td>0.5~1.0</td> </tr> </tbody> </table> <ul style="list-style-type: none"> Oil groove width, depth (reference) Width: 2 to 5 mm Depth: 4 to 5 mm Three or more oil grooves should be provided. Sealing effectiveness can be further improved by filling the oil groove portion with grease of which ASTM worked penetration is 150 to 200. Grease is generally used as the lubricant for labyrinth seals, and, except in low speed applications, is commonly used together with other sealing devices. 	Oil groove clearance (approx.)		Shaft diameter mm	Clearance mm	Up to 50	0.2~0.4	50 or larger	0.5~1.0
	Oil groove clearance (approx.)											
	Shaft diameter mm	Clearance mm										
	Up to 50	0.2~0.4										
	50 or larger	0.5~1.0										
		Oil groove seal (oil grooves on housing side)	Several concentric oil grooves are provided on the housing inner diameter to improve the sealing effectiveness. When the grooves are filled with lubricant, the ingress of external contaminants is prevented.									
	Oil groove seal (oil grooves on shaft side and housing side)	Oil grooves are provided on both the shaft outer diameter and housing inner diameter for a seal with even greater sealing effectiveness.										
	Axial labyrinth seal	This seal has a labyrinth passageway on the axial side of the housing.										
	Radial labyrinth seal	A labyrinth passageway is located on the radial side of the housing. For use with split housings. This offers better sealing effectiveness than axial labyrinth seals.										
	Aligning type labyrinth seal	The seal's labyrinth passageway is slanted and has sufficient clearance to prevent contact between the housing projections and the shaft, even as the shaft realigns.										

Type	Seal construction	Designation	Seal characteristics and selection considerations																																									
Non-contact seals		Oil comb sleeve	<p>In this design, lubricating oil that makes its way out of the housing along the shaft is thrown off by projections on the oil comb sleeve and recirculated.</p> <p>Cautionary points regarding selection</p> <ul style="list-style-type: none"> Seal type that utilizes centrifugal force of the slinger mounted on rotating shaft. If mounted on the inside of the housing, the slinger should function to seal in lubricant by the centrifugal force produced by rotation. If mounted on the outside of the housing, the slinger should function to seal out foreign matter by the fan effect produced by rotation. These seal types are commonly employed together with other sealing devices. 																																									
		Slinger provided in the housing																																										
		Slinger provided outside the housing																																										
Contact seals		Z grease seal	<p>In cross section resembling the letter "Z"; this seal's empty spaces are filled with grease. The seal is commonly used with a plummer block (housing).</p> <p>V-ring seal</p> <p>This design enhances sealing efficiency with a lip that seals from the axial direction. With the aid of centrifugal force, this seal also offers effective protection against dust, water, and other contaminants entering the bearing. Can be used for both oil and grease lubrication. At seal peripheral speeds in excess of 12 m/s, seal ring fit is lost due to centrifugal force, and a clamping band is necessary to hold it in place.</p> <p>Oil seal</p> <p>Oil seals are widely used, and their shapes and dimensions are standardized under JIS B 2402. In this design, a ring-shaped spring is installed in the lip section. As a result, contact pressure is exerted between the lip edge and shaft surface, and sealing effectiveness is good.</p> <p>Cautionary points regarding selection</p> <table border="1"> <thead> <tr> <th rowspan="2">Peripheral speed m/s</th> <th colspan="2">Surface roughness</th> </tr> <tr> <th><i>R_a</i></th> <th><i>R_z</i></th> </tr> </thead> <tbody> <tr> <td>~ 5</td> <td>0.8</td> <td>3.2</td> </tr> <tr> <td>5~10</td> <td>0.4</td> <td>1.6</td> </tr> <tr> <td>10~</td> <td>0.2</td> <td>0.8</td> </tr> </tbody> </table> <p>Shaft material (reference)</p> <table border="1"> <thead> <tr> <th>Material</th> <th>Machine structural carbon steel Low carbon alloy steel Stainless steel</th> </tr> </thead> <tbody> <tr> <td>Surface hardness</td> <td>HRC 40 or higher necessary HRC 55 or higher advisable</td> </tr> <tr> <td>Processing method</td> <td>Final grinding without repeat (moving), or buffed after hard chrome plating</td> </tr> </tbody> </table> <p>Allowable speed/temperature according to seal type/material (reference)</p> <table border="1"> <thead> <tr> <th>Seal type/material</th> <th>Allowable peripheral speed m/s ($v(m/s) = \frac{\pi \times d(mm) \times n(\text{min}^{-1})}{60\,000}$)</th> <th>Allowable temp °C</th> </tr> </thead> <tbody> <tr> <td rowspan="3">Oil seal</td> <td>Nitrile rubber</td> <td>16 or below</td> <td>-25 ~120</td> </tr> <tr> <td>Acrylic rubber</td> <td>26 or below</td> <td>-15 ~150</td> </tr> <tr> <td>Fluorinated rubber</td> <td>32 or below</td> <td>-30 ~200</td> </tr> <tr> <td>Z grease seal</td> <td>Nitrile rubber</td> <td>6 or below</td> <td>-25 ~120</td> </tr> <tr> <td>V-ring</td> <td>Nitrile rubber</td> <td>40 or below</td> <td>-25 ~120</td> </tr> </tbody> </table> <p>When the bearing and oil seal are in close proximity, the internal clearance of the bearing may be reduced by heat produced by the oil seal. In addition to considering the heat generated by contact seals at various peripheral speeds, internal bearing clearances must also be selected with caution.</p> <p>Depending on its orientation, the seal may function to prevent lubricant from leaking out or foreign matter from getting in.</p> <p>For dust proof For preventing lubricant leakage</p>	Peripheral speed m/s	Surface roughness		<i>R_a</i>	<i>R_z</i>	~ 5	0.8	3.2	5~10	0.4	1.6	10~	0.2	0.8	Material	Machine structural carbon steel Low carbon alloy steel Stainless steel	Surface hardness	HRC 40 or higher necessary HRC 55 or higher advisable	Processing method	Final grinding without repeat (moving), or buffed after hard chrome plating	Seal type/material	Allowable peripheral speed m/s ($v(m/s) = \frac{\pi \times d(mm) \times n(\text{min}^{-1})}{60\,000}$)	Allowable temp °C	Oil seal	Nitrile rubber	16 or below	-25 ~120	Acrylic rubber	26 or below	-15 ~150	Fluorinated rubber	32 or below	-30 ~200	Z grease seal	Nitrile rubber	6 or below	-25 ~120	V-ring	Nitrile rubber	40 or below	-25 ~120
	Peripheral speed m/s	Surface roughness																																										
		<i>R_a</i>		<i>R_z</i>																																								
	~ 5	0.8		3.2																																								
	5~10	0.4		1.6																																								
10~	0.2	0.8																																										
Material	Machine structural carbon steel Low carbon alloy steel Stainless steel																																											
Surface hardness	HRC 40 or higher necessary HRC 55 or higher advisable																																											
Processing method	Final grinding without repeat (moving), or buffed after hard chrome plating																																											
Seal type/material	Allowable peripheral speed m/s ($v(m/s) = \frac{\pi \times d(mm) \times n(\text{min}^{-1})}{60\,000}$)	Allowable temp °C																																										
Oil seal	Nitrile rubber	16 or below	-25 ~120																																									
	Acrylic rubber	26 or below	-15 ~150																																									
	Fluorinated rubber	32 or below	-30 ~200																																									
Z grease seal	Nitrile rubber	6 or below	-25 ~120																																									
V-ring	Nitrile rubber	40 or below	-25 ~120																																									
	V-ring seal																																											
	Oil seal																																											
	For dust proof																																											
	For preventing lubricant leakage																																											

Type	Seal construction	Designation	Seal characteristics and selection considerations
Combination seals		Z-seal + Labyrinth seal	<p>This is an example of an axial labyrinth seal which has been combined with a Z seal to increase its sealing effectiveness. The axial labyrinth seal is affixed to the shaft with a setting bolt or other method. In the diagram on the left, both the direction of the Z-seal and the labyrinth seal are oriented to keep dust and other contaminants out of the bearing. Because a Z-seal has been incorporated, the allowable peripheral speed should not exceed 6 m/s.</p> <p>Labyrinth seal + Oil groove seal + Slinger</p> <p>This is an example of a combination of three different non-contact seals. It has the advantage of preventing both lubricant leakage from inside the bearing and infiltration of dust and other contaminants from the outside. It is widely used on mining equipment and as a sealing system with plummer blocks in extremely dusty application conditions.</p> <p>Oil groove seal + Slinger + Z-seal</p> <p>This is an example where an oil groove seal and slinger have been combined with a Z-seal to increase its sealing efficiency. In the diagram on the left, all three seals have been oriented to keep dust and other contaminants out of the bearing. It is widely used on mining equipment and as a sealing system with plummer blocks in extremely dusty application conditions.</p>
		Labyrinth seal + Oil groove seal + Slinger	
		Oil groove seal + Slinger + Z-seal	

13. Bearing materials

13.1 Raceway and rolling element

While the contact surfaces of a bearing's raceways and rolling elements are subjected to repeated heavy stress, they must also maintain high precision and rotational accuracy.

To accomplish this, the raceways and rolling elements must be made of a material that has high hardness, is resistant to rolling fatigue, is wear resistant, and has good dimensional stability. The most common cause of fatigue in bearings is the inclusion of non-metallic inclusions in the steel. Nonmetallic inclusions contain hard oxides that can cause fatigue cracks. Clean steel with minimal non-metallic inclusions must therefore be used.

All NTN bearings use steel that is low in oxygen content and nonmetallic impurities, refined by a vacuum degassing process and outside hearth smelting. For bearings requiring especially high reliability and long life, steels of even higher in purity, such as vacuum melted steel (VIM / VAR) and electro-slag melted steel (ESR), are used.

13.1.1 Raceway and rolling element materials

1) High/mid carbon alloy steel

In general, steel types capable of being "through hardened" below the material surface are employed for raceways and rolling elements. Foremost among these is **high carbon chromium bearing steel**, which is widely used. For large type bearings and bearings with large cross sectional dimensions, induction hardened bearing steel is used, which incorporates manganese(Mn) or molybdenum(Mo). Midcarbon chromium steel incorporating silicon(Si) and manganese may also be used, which gives it hardening properties comparable to high carbon chromium steel.

Table 13.1 (A-140) gives the chemical composition of representative high carbon chrome bearing steels that meet JIS G 4805. SUJ2 is frequently used. SUJ3, with enhanced hardening characteristics containing a large quantity of Mn, is used for large bearings. SUJ5 is SUJ3 to which Mo has been added to further enhance hardening characteristics, and is used for oversized bearings or bearings with thick walls.

Table 13.1 (A-140) lists the chemical composition of the primary materials that are equivalent or similar to these JIS high carbon chrome bearing steels. The chemical composition of JIS SUJ2 is nearly equivalent to that of AISI, SAE standard 52100, German DIN standard 100Cr6, and Chinese GB standard GCr15.

2) Carburizing (case hardened) steel

Carburizing hardens the steel from the surface to the proper depth, leaving a relatively soft core. This provides **hardness and toughness**, making the material **suitable for impact loads**. NTN uses carburizing (case hardened) steel for most of its tapered roller bearings. In terms of case hardened steel for NTN's other bearings, chromium steel and chrome molybdenum steel are used for small to medium sized bearings, and nickel chrome molybdenum steel is used for large sized bearings. **Table 13.2** (A-141) shows the chemical composition of representative carburizing steels of JIS.

The table lists the chemical composition of similar materials. The chemical composition of JIS SCM420 is nearly equivalent to that of AISI, SAE standard 4118, German DIN standard 20CrMo4 or 25CrMo4. Chinese GB standard has a slightly different amount of Cr and Mo compared with G20CrMo.

3) High temperature capable bearing steel

When bearings made of ordinary high carbon chromium steel which have undergone standard heat treatment are used for long durations at high temperatures, unacceptably large dimensional changes can occur as described in section 13.1.2. For this reason, a **dimension stabilizing treatment** (TS treatment) has been devised for very high temperature applications. This treatment however reduces the hardness of the material, thereby reducing rolling fatigue life. (See section "3.3.2 Bearing characteristics factor a_2 " on page A-22.) Note that dimensional changes can occur in normal use too.

Standard high temperature bearings for use at temperatures from **150°C - 200°C**, add silicon to the steel to improve heat resistance. This results in a bearing with excellent rolling fatigue life with minimal dimensional change or softening at high temperatures.

A variety of heat resistant steels are also incorporated in bearings to minimize softening and dimensional changes when used at high temperatures. Two of these are high-speed molybdenum steel and high-speed tungsten steel. For bearings requiring heat resistance in high speed applications, there is also heat resistant case hardened molybdenum steel (see **Table 13.3** on A-142).

4) Corrosion resistant bearing steel

For applications requiring high corrosion resistance, **stainless steel** is used. To achieve this corrosion resistance, a large proportion of the alloying element chrome is added to martensitic stainless steel (**Table 13.4** on A-142).

5) Induction hardened steel

Besides the use of surface hardening steel, induction hardening is also utilized for bearing raceway surfaces, and for this purpose **mid-carbon steel** is mainly used for its lower carbon content instead of through hardening steel.

Table 13.5 (A-142) shows the chemical composition of the primary materials that are similar to the representative medium carbon steels (machine structural carbon steels) of JIS used for small products. For deep hardened layers required for **larger bearings and bearings with large surface dimensions, mid-carbon steel is fortified with chromium and molybdenum**.

6) Other bearing materials

For ultra high speed applications and applications requiring very high level corrosion resistance, ceramic bearing materials such as Si₃N₄ are also available.

13.1.2 Properties and characteristics of bearing Materials

1) Physical and mechanical properties of bearing materials (besides resin)

Table 13.6 and Table 13.7 (A-143) show physical and mechanical properties of the representative materials used for raceways, rolling elements, and cages.

2) Dimensional change of bearings

Dimensions of bearings used for a long time may change depending on the use condition. This phenomenon is called dimensional change.

<Mechanism of dimensional change>

A standard bearing steel structure contains a small amount of austenite in the matrix of hard martensite. This austenite is partially retained austenite without being transformed into martensite in the cooling process of the bearing steel quenching process, and is called residual austenite.

Since the residual austenite is an unstable structure, it is transformed into a stable structure (martensite) when the bearing is being used. This structure transformation is the cause of the dimensional change of bearings.

Fig. 13.1 shows measured values of dimensional change of a standard bearing held at 120°C over an extended period of time.

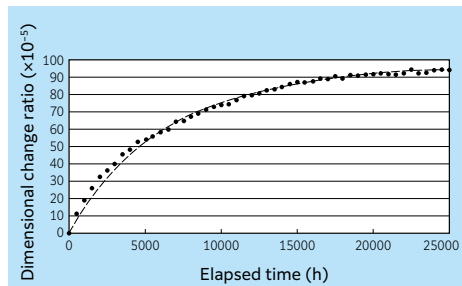

Fig. 13.1 Example of dimensional change rate of standard bearings that are held at 120°C for a long time (measured values)

The dimensional change rate becomes larger as the elapsed time or the temperature of exposure increases.

Depending on the use condition, dimensional change may occur with bearings made of general bearing steel that did not reach 100°C, which is the normal limit.

Bearings that underwent dimension stabilization treatment (TS treatment) have a significantly lower dimensional change. For details, please contact NTN Engineering.

<Dimensional change problems and countermeasures>

Among dimensional change, particular attention should be paid to inner ring expansion. When the inner ring expands by dimensional change, the interference between the inner ring and the shaft decreases, and the bearing may be heavily damaged by creeping or axial movement. Therefore, when a bearing is to be used for a long time, the bearing specifications and fixing method must be determined with the interference decrease due to dimensional change taken into consideration. For example, the interference can be increased (see section "7. Bearing fits") or fixing in the axial direction can be reinforced (see section "14. Shaft and housing design").

<Situations to monitor dimensional change>

The dimensional change of bearings is expressed by the bearing dimension × dimensional change rate. Therefore, under a given temperature and elapsed time, larger bearings show greater dimensional change. Pay particular attention to the amount of dimensional change when large bearings are to be used with fits with small interference.

In addition, dimensional change does not occur during the rotation inspection immediately following bearing installation. It is observed after a long-period operation. Therefore, for machines and parts used for a long time, periodic inspection

is effective for preventing problems. For detailed consideration, please consult NTN beforehand.

13.2 Cage

Bearing cage materials must have the strength to withstand rotational vibrations and shock loads. These materials must also have a low friction coefficient, be lightweight, and be able to withstand bearing operating temperatures.

13.2.1 Metal materials

For small and medium sized bearings, pressed steel cages of cold or hot rolled material with a low carbon content of approx. 0.1% are used. However, depending on the application, austenitic stainless steel is also used. Machined cages are generally used for large bearings. Carbon steel for machine structures or high-strength cast brass is frequently used for the cages, but other materials such as aluminum alloy are also used. Table 13.8 and Table 13.9 (A-143) show the chemical composition of the representative cage materials.

Besides high-strength brass, medium carbon nickel, chrome and molybdenum steel that has been hardened and tempered at high temperatures are also used for bearings used in aircraft. The materials are often plated with silver to enhance lubrication characteristics.

13.2.2 Resin materials

Recently resin cages are used in place of metals because the material is lightweight and easy to mold into complicated shapes. On the other hand, resins have disadvantages such as lower strength and heat resistance. Therefore, it is important to select resin materials that take advantage of their characteristics. Table 13.10 (A-144) shows the characteristics of the representative cage resin materials. These materials are rarely used without being filled, and are usually reinforced with glass fiber (GF) or carbon fiber (CF).

[Characteristics of resin materials]

(Advantages)

- Lightweight
- High corrosion resistance
- High self-lubricating performance with less abrasion powder
- Low noise
- Can easily be molded into complicated shapes and various designs
- High productivity

(Disadvantages)

- Lower strength compared with metal
- Lower heat resistance compared with metal
- The strength and elastic modulus largely vary widely with temperature.
- The physical properties (strength) may change when resins are exposed to high temperatures for a long period.
- The strength may deteriorate when resins are exposed to certain types of chemical or oils.
- The thermal expansion coefficient is high, and the dimensional change is larger compared with metal.

<<Polyamide (PA): 66, 46>>

Polyamide is suitable for general cage materials because it is low cost and has high strength, heat resistance, wear resistance, and formability. This material has disadvantages such as high water absorbency, physical property deterioration and dimensional change due to water absorption. On the other hand, water absorption increases flexibility and toughness, enhancing the ease of assembly and shock resistance of cages. However, the physical property (strength) may deteriorate rapidly at high temperatures when polyamide is exposed to lubricating oil containing an S (sulfur) type or P (phosphorus) type extreme pressure additive.

Polyamide 66 reinforced with glass fibers is the most used material because it has excellent performance as a cage material.

<<Polyphenylene sulfide (PPS)>>

Polyphenylene sulfide has high heat resistance (continuous operating temperature: 220 to 240°C), chemical resistance, melt fluidity, and formability.

<<Polyetheretherketone (PEEK)>>

Polyetheretherketone has the highest heat resistance among thermoplastic resins (continuous operating temperature: 240 to 260°C). It has excellent self-lubricating

performance, shock resistance, and chemical resistance, but it is very expensive. It is mainly used for cages of high-speed bearings for machine tools.

<<Fabric reinforced phenolic resin>>

Phenolic resin is a thermosetting resin. It overcomes the disadvantages of hard and brittle phenolic resin having low shock resistance using fabric reinforcement. It is lightweight and has high lubricity and good mechanical properties. Injection molding cannot be performed because of the thermosetting property, so cages are made by machining. It is mainly used for cages of high-speed angular contact ball bearings for machine tools.

13.3 Rubber seal materials

Synthetic rubbers with high heat resistance and oil resistance are used as materials for seals. Different rubber is used depending on the degree of heat resistance.

Table 13.11 (A-144) shows the representative characteristics of the rubber materials.

<<Nitrile rubber (NBR)>>

Nitrile rubber has high oil resistance, heat resistance, and wear resistance, and is widely used as a general material for seals. The operating temperature range is -20 to 120°C.

<<Acrylic rubber (ACM)>>

Acrylic rubber has high heat resistance and can be used above the application temperature of NBR. It has excellent oil resistance but swells in ester oil. An ester oil resistant grade is also available. The operating temperature range is -15 to 150°C.

<<Fluorinated rubber (FKM)>>

Fluorinated rubber is a rubber material having excellent heat resistance, oil resistance, and chemical resistance. It is deteriorated by amine, so attention needs to be paid when combining fluorinated rubber with urea grease that precipitates amine at high temperatures. The

operating temperature range is -30 to 230°C.

13.4 Periphery of bearing (shaft, housing)

Table 13.12 (A-145) and Table 13.13 (A-145) show physical and mechanical properties of representative materials used for shafts and housings. Heat treatment is applied to bearing materials that are used under large loads. Steel with enhanced bending strength and wear resistance (fretting strength) is used. For such applications, bearing materials (Table 13.6 and Table 13.7 on A-143) may also be used as shaft materials.

For housing materials that are used under large loads, heat treatment is applied, and materials with enhanced wear resistance (fretting strength) are used. For lightweight applications, aluminum alloy is widely used.

13.5 NTN bearings with prolonged life

NTN is promoting approaches and research and development from various perspectives with respect to long operating life of bearings. Two examples of approaches for bearing materials and heat treatment, (1) TAB/ETA/EA bearings and (2) FA tapered roller bearings will be introduced in the following sections.

13.5.1 TAB/ETA/EA bearing series

1) Characteristics

(1) Effective for lubrication conditions with foreign matter having high hardness

The main cause of the damage of transmission bearings of automobiles is foreign matter in the lubricating oil. TAB/ETA/EA bearings can be used to prolong the operating life of machines under such contaminated lubricating oil conditions.

(2) High peeling strength

Peeling damage is often caused by deterioration of lubrication conditions during use. The limit life can be prolonged by enhancing the bearing's peeling resistance.

2) Mechanism of prolonged bearing life

Bearing damage is often seen on the raceway surface. By applying heat treatment and selecting appropriate materials, the surface structure has enhanced toughness and improved resilience without impairing the surface hardness. In addition, for tapered roller bearings, crowning is also optimized. These suppress suppresses the occurrence of small cracks that might become the starting point of peeling and damage, prolonging the operating life.

(1) Crack resistance and stress releasing effect

The residual austenite, which is softer than the martensitic parent phase, has an effect of relieving stress concentrations acting on the periphery of the dent formed by foreign matter on the rolling contact surface under lubrication conditions with foreign matter mixed into the oil, thereby suppressing the occurrence of cracks.

As shown in Fig. 13.2, all the residual stress on the top surface of the dent part is shifted to the tensile side. The standard heat-treated product of through hardened steel has residual tensile stress. When a specially heat-treated product and a standard heat-treated product are compared, the special heat treated material has less shifting of stresses to the tensile side, which can be harmful, and a stress release action is observed.

(2) Reason for long operating life

ETA and EA bearings have a structure with an

appropriate amount of residual austenite and carbide dispersed on the surface region, and the structure is thermally stabilized by the special heat-treatment mentioned above.

The qualities of the material (residual stress, hardness, micro-structure) of a raceway surface generally change due to heat generation and shearing stress action during rolling contact, leading to fatigue cracks. Therefore, improving resistance to temper softening is effective to prevent surface-initiated damage. The residual austenite obtained by ordinary carburizing can suppress generation and progress of cracks and is work-hardened during use (the strength increases). Therefore, by using an appropriate amount of it, the material becomes tough. However, it is unstable against heat. On the other hand, when nitrogen is introduced and diffused under an appropriate condition, a matrix of residual austenite and martensite parent phase that is stable against heat is formed, and the material becomes resilient against quality changes.

3) Supported bearing sizes

Table 13.15

● Deep groove ball series	● Tapered roller series
TAB000 to TAB020	All types that have bearing diameter to be equal to or lower than $\phi 600$
TAB200 to TAB217	
TAB300 to TAB311	

For other types besides the above, please contact NTN Engineering.

Table 13.14 Comparison of dent shapes of each material

Material		Surface hardness [HRC]	Residual austenite amount [%]	Dent diameter [mm]	Dent depth [μm]	Protrusion amount [μm]
Through hardened steel	Standard bearing	62.0	10	2.40	80	5
	TAB bearing	62.0	28	2.45	83	4
Carburizing steel	Standard bearing	61.0	25	2.80	102.5	1
	ETA bearing	62.5	29	2.63	97.5	1

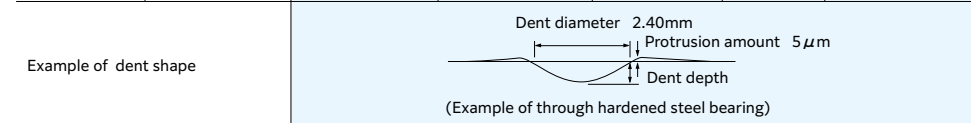

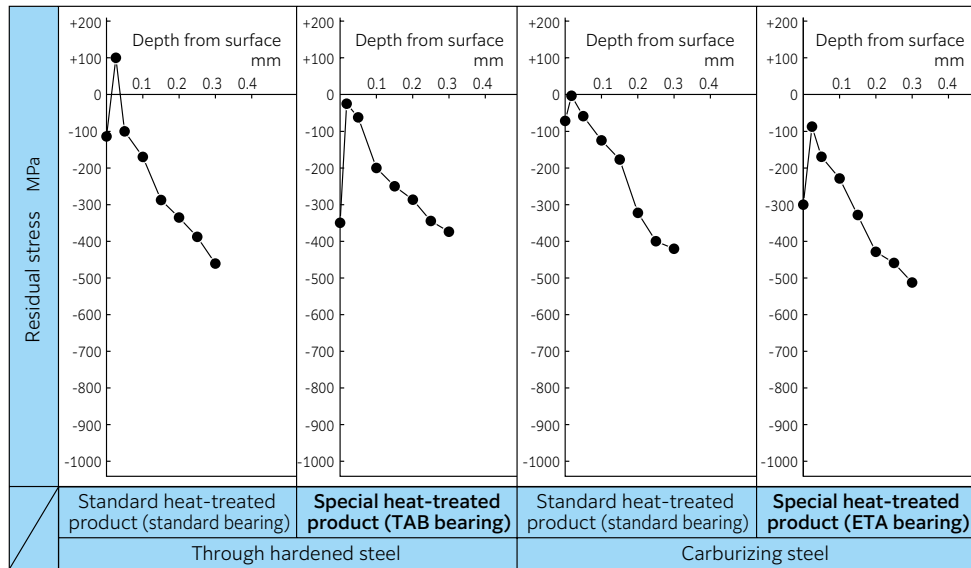

Fig. 13.2 Residual stress within a dent

4) Operating life test

The life test results of a standard bearing, a TAB bearing, and an ETA bearing are shown, but the data is for reference because it varies depending on the type of foreign matter under the contaminated lubricant condition.

(1) Tested bearings and test conditions

Table 13.16 shows tested bearings, and Table 13.17 and Table 13.18 shows the test conditions.

(2) Operating life data

Condition of lubricating oil containing foreign matter (reference)

Fig. 13.3 and Fig. 13.4 show the results of tests conducted under lubrication conditions mixed with NTN standard foreign matter.

Table 13.16 Tested bearings

Bearing name	Boundary dimensions (mm)
Standard 6206	$\phi 30 \times \phi 62 \times 16$
TAB bearing TAB206	↑
Standard 30206	$\phi 30 \times \phi 62 \times 17.25$
ETA bearing ETA-30206	↑

Table 13.17 Test condition (6206, TAB206)

Radial load (kN)	6.9
Rotational speed (mm ⁻¹)	2 000
Lubricating oil	Turbine 56 + NTN standard foreign matter
Lubrication method	Oil bath

Table 13.18 Test condition (30206, ETA-30206)

Radial load (kN)	17.64
Rotational speed (mm ⁻¹)	2 000
Lubricating oil	Turbine 56 + NTN standard foreign matter
Lubrication method	Oil bath

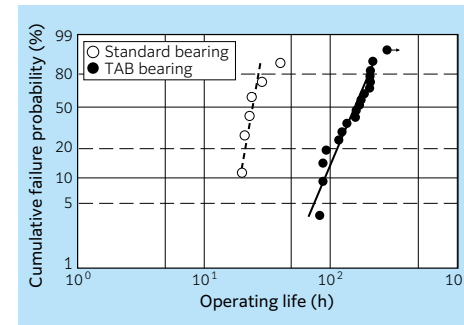

Fig. 13.3 Operating life comparison between TAB deep groove bearing and standard bearing (mixed with foreign matter)

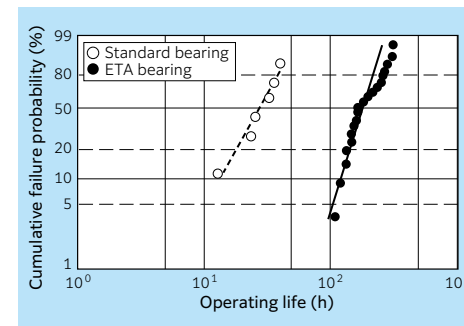

Fig. 13.4 Operating life comparison between ETA tapered roller bearing and standard bearing (mixed with foreign matter)

13.5.2 FA tapered roller bearings

NTN developed special heat treatment (FA treatment) for refining crystal grains of bearing steel to half or less the size of the conventional ones by focusing on refining strengthening of crystal grains. (See Fig. 13.5) NTN adopted this technique for “FA tapered roller bearings,” thereby improving the indentation resistance and realizing long operating life under the lubrication conditions including foreign matter. Further, by combining optimization techniques for the internal bearing design acquired during development of the ECO-Top series, the seizure resistance is improved and the bearing size can be greatly reduced.

Remarks: FA is an abbreviation of fine austenite strengthening treatment.

FA treatment (Fine Austenite Strengthening)

- Longer operating life is realized by crystal grain refinement of bearing steel.
- The crystal grains of bearing steel are refined to half or less the size of the conventional ones.

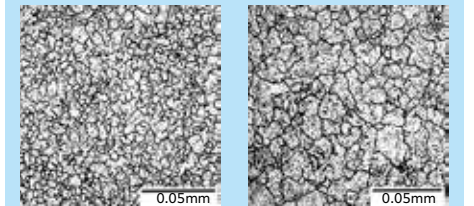

FA treated product Normal hardened product

Fig. 13.5 Former austenite crystal grain boundary

1) Longer operating life

- Rolling fatigue life is improved by crystal grain refinement.
- The residual austenite amount is optimized by carbonitriding, and resistance to surface-initiated damage caused by rolling over foreign matter is improved by the crystal grain refinement technique.

• Special crowning that is designed to obtain optimum surface pressure distribution under light to heavy load conditions is adopted.

Thus, the operating life under the lubrication condition including oil types and foreign matter close to the actual machine was greatly extended compared with the standard product.

2) Optimum oil film formation design

The rib area of a tapered roller bearing has sliding contact, and the quality of the oil film forming capability of this area greatly affects the bearing performance.

In the FA tapered roller bearing, the oil film forming capability of the rib area is improved by optimization techniques involving parameters such as the shape, accuracy, and roughness of the contact area of the flange and the roller acquired during ECO-Top bearing development. Thus, the rotational torque is reduced, and the seizure resistance and the preload loss resistance are improved.

3) Seating of assembly width

When a tapered roller bearing is to be used under preload, it is necessary to give sufficient stable rotation to the bearing and bring the bearing into a proper state in which the roller end surface and the inner ring rib surface are brought into contact with each other.

The smaller the number of stable rotations, the more reliably the preload setting can be achieved, and the assembly work becomes more efficient.

With FA tapered roller bearings, preload can reliably be set in a short time by the optimization of the internal bearing design. For example, it may become possible to stop applying gear oil to help achieve early stabilization. The roller becomes stable at a rotation speed equal to that of a conventional bearing by using only rust preventative oil.

4) Improvement in indentation resistance

To make bearings smaller, it is necessary to improve the indentation resistance to prevent safety factor decrease caused by a decrease of the static load rating.

Regarding FA tapered roller bearings, the indentation depth is less than one ten-thousandth of the rolling element diameter even under the static load with a safety factor (S_0) = 0.6.

5) Test data

(1) Operating life

(Condition of linear contact type operating life test)

Test machine : NTN linear contact life test machine
 Test piece : $\phi 12 \times L12, R480$
 The other test piece : $\phi 20$ Roller(SUJ2)
 Load (kN) : 13.74
 Contact stress (Mpa) : 4 155 (P_{max})
 Lubricating oil : Turbine oil 68

Table 13.19 Result of operating life test under clean lubricating oil condition (Result of comparison test with linear contact type test piece)

Heat treatment method	L_{10} operating life, $\times 10^4$ cycles	L_{10} life ratio
4Top	1 523	1.0
ECO-Top(ETA)	3 140	2.1
FA	4 290	2.8

* L_{10} life ratio is the comparison when 4Top is 1.0.

(Condition of bearing operating life test)

Test machine : NTN life test machine
 Tested bearings : (1)30206
 (2)30306D
 Test load : (1) $F_r = 17.64$ kN, $F_a = 1.47$ kN
 (2) $F_r = 19.6$ kN, $F_a = 13.72$ kN
 Rotational speed : 2 000min⁻¹
 Lubrication : (1)Turbine oil 56 oil bath (30 ml)
 (2)ATF oil bath (50 ml)
 Foreign matter : (1)50 μ m or below : 90wt% } 1.0g/l
 100~180 μ m : 10wt% }
 (2)50 μ m or below : 75wt% } 0.2g/l
 100~180 μ m : 25wt% }
 Calculated operating life : (1)169h (No foreign matter)
 (2)171h (No foreign matter)

Table 13.20 Result of operating life test under lubrication condition including foreign matter (Result of comparison test by bearings)

Test condition		4Top	ECO-Top(ETA)	FA
Condition (1)	L_{10} operating life (h)	52.4	314.9	415.6
	L_{10} life ratio	1.0	6.0	7.9
Condition (2)	L_{10} operating life (h)	22.5	—	309.7
	L_{10} life ratio	1.0	—	13.8

* L_{10} life ratio is the comparison when 4Top is 1.0.

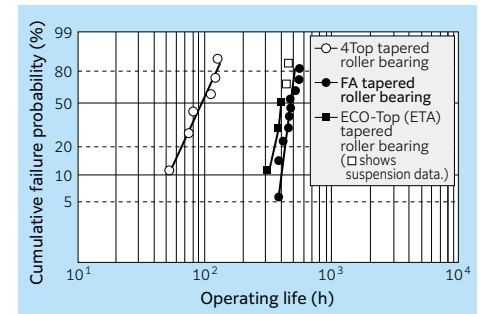

Fig. 13.6 Condition (1) 30206 operating life test result (lubrication condition including foreign matter)

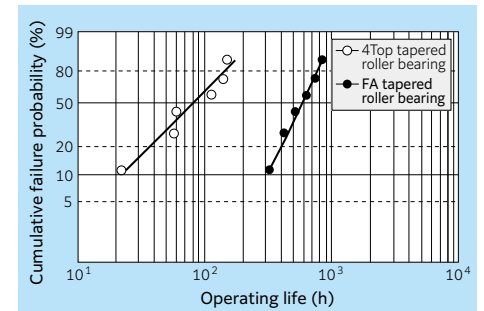

Fig. 13.7 Condition (2) 30306D operating life test result (lubrication condition including foreign matter)

(2) Rotational torque

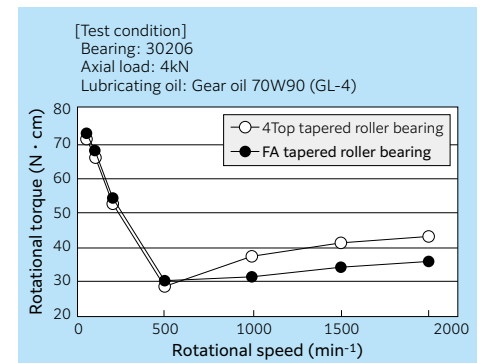

Fig. 13.8 Result of rotational torque measurement

(3) Seizure resistance

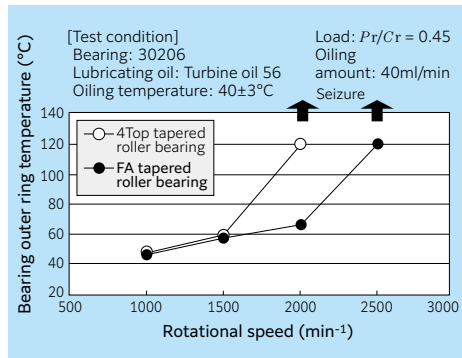

Fig. 13.9 Results of temperature rise test

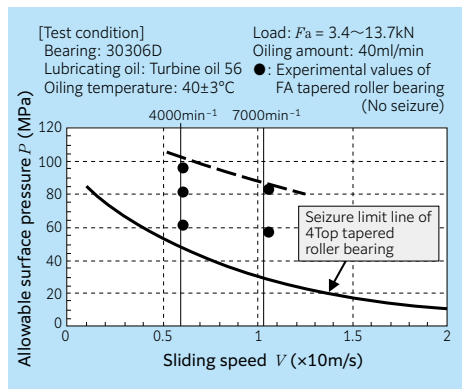

Fig. 13.10 Results of PV limit test

(4) Preload release resistance

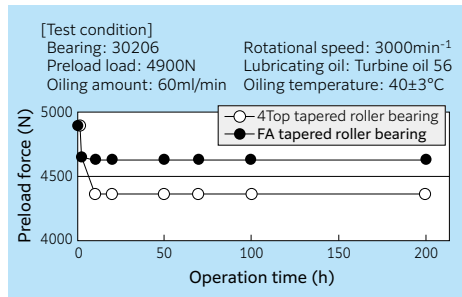

Fig. 13.11 Results of preload release test

(5) Seating of assembly width

Bearing : 30206
 Axial load : 29.4N
 Test method: A bearing is placed in the configuration shown in the figure, and an axial load (weight) is applied to rotate the inner ring. The drop amount of the inner ring for each rotation is measured to obtain the rotational speed until it is stable.

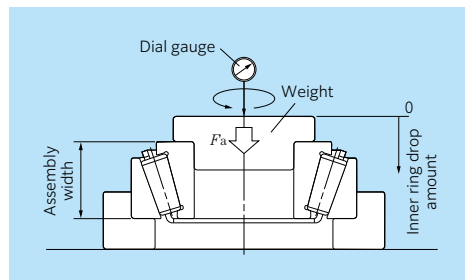

Fig. 13.12 Measurement method of revolutions to seated bearing width

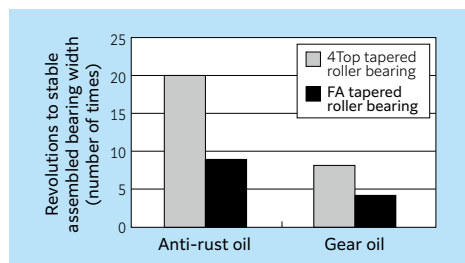

Fig. 13.13 Measurement result of revolutions to seated bearing width

(6) Indentation resistance

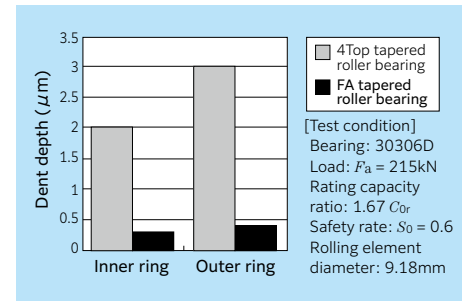

Fig. 13.14 Measurement result of dent depth

6) Downsizing with FA tapered roller bearing

Improvement in the bearing life, seizure resistance, and indentation resistance strength allows the compact ratio below by adopting an FA tapered roller bearing (Fig. 13.15).

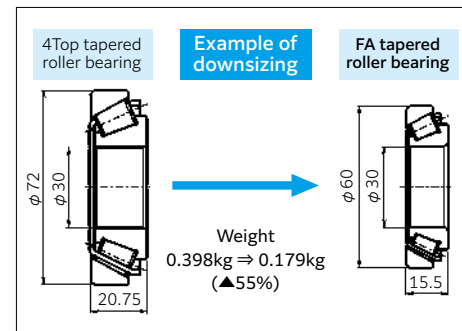

Fig. 13.15 Example of compact ratio

7) Supported bearing size

The target bearings are bearings with an outer diameter of $\phi 145$ or below. Contact NTN Engineering for details.

13.6 Bearing fatigue analysis technique

In a region subjected to plastic deformation due to rolling fatigue, various X-ray analysis parameters obtained by X-ray stress measurements (residual stress, diffraction half-value width, and residual austenite) may be observed. There is a technique that estimates the degree of progress of rolling fatigue (degree of fatigue) based on the X-ray stress measurement result using this characteristic (Fig. 13.16). Since the mid-1980s, NTN has been investigating the relationship between the X-ray analysis value (fatigue degree in Fig. 13.16) and the life ratio (a value expressed by the percentage of the operating time in which peeling occurred is 100%) for surface-initiated damage (peeling and early peeling starting from dents), which has been frequently observed in the field. Since the relationship changes depending on various rolling conditions (combination of surface roughness, load, and lubrication condition), the values are used for reference; however, the remaining operating life can be estimated by using this relationship diagram.

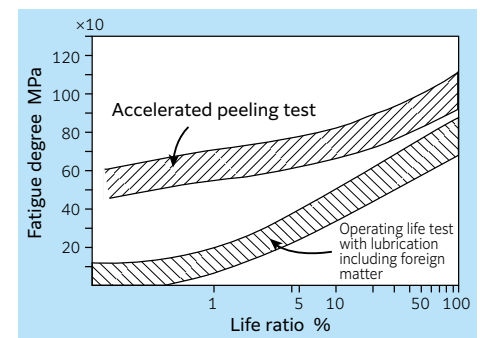

Fig. 13.16 Relationship between degree of fatigue and life ratio

Recently, fatigue degree estimation is being studied using variation in X-ray diffraction ring peak intensity with high sensitivity even in the latter stage of fatigue.

Table 13.1 Chemical composition of representative high carbon chrome bearing steels

Country name	Standard name	Code	Main chemical composition (%)								Equivalent/ approximate steel of JIS
			C	Si	Mn	P	S	Ni	Cr	Mo	
Japan	JIS G 4805 (2008)	SUJ2	0.95 ~1.10	0.15 ~0.35	≤0.50	≤0.025	≤0.025	≤0.25	1.30 ~1.60	≤0.08	
		SUJ3	0.95 ~1.10	0.40 ~0.70	0.90 ~1.15	≤0.025	≤0.025	≤0.25	0.90 ~1.20	≤0.08	
		SUJ4	0.95 ~1.10	0.15 ~0.35	≤0.50	≤0.025	≤0.025	≤0.25	1.30 ~1.60	0.10 ~0.25	
		SUJ5	0.95 ~1.10	0.40 ~0.70	0.90 ~1.15	≤0.025	≤0.025	≤0.25	0.90 ~1.20	0.10 ~0.25	
USA	ASTM A1040 (2010)	50100	0.98 ~1.10	0.15 ~0.35	0.25 ~0.45	≤0.025	≤0.025	≤0.25	0.4 ~0.6	≤0.10	
		51100	0.98 ~1.10	0.15 ~0.35	0.25 ~0.45	≤0.025	≤0.025	≤0.25	0.90 ~1.15	≤0.10	
	ASTM A295/295M (2014) AISI A295/295M (2014) SAE AMS 6440S (2015)	52100	0.93 ~1.05	0.15 ~0.35	0.25 ~0.45	≤0.025	≤0.015	≤0.25	1.35 ~1.60	≤0.10	SUJ2
		ASTM A485 (2014)	A485 Grade1	0.90 ~1.05	0.45 ~0.75	0.90 ~1.20	≤0.025	≤0.015	≤0.25	0.90 ~1.20	≤0.10
France/ Germany	NF EN ISO 683-17 (2014) DIN EN ISO 683-17 (2014)	100Cr6	0.93 ~1.05	0.15 ~0.35	0.25 ~0.45	≤0.025	≤0.015	—	1.35 ~1.60	≤0.10	SUJ2
		100CrMnSi4-4	0.93 ~1.05	0.45 ~0.75	0.90 ~1.20	≤0.025	≤0.015	—	0.9 ~1.20	≤0.10	SUJ3
		100CrMnSi6-4	0.93 ~1.05	0.45 ~0.75	1.00 ~1.20	≤0.025	≤0.015	—	1.40 ~1.65	≤0.10	
		100CrMo7	0.93 ~1.05	0.15 ~0.45	0.25 ~0.45	≤0.025	≤0.015	—	1.65 ~1.95	0.15 ~0.30	
		100CrMo7-3	0.93 ~1.05	0.15 ~0.45	0.60 ~0.80	≤0.025	≤0.015	—	1.65 ~1.95	0.20 ~0.35	
		100CrMnMoSi8-4-6	0.93 ~1.05	0.40 ~0.60	0.80 ~1.10	≤0.025	≤0.015	—	1.80 ~2.05	0.50 ~0.60	
Germany	DIN	105Cr4	1.00 ~1.10	0.15 ~0.35	0.25 ~0.40	≤0.030	≤0.025	—	0.90 ~1.15	—	
China	GB/T 18254 (2002)	GCr4	0.95 ~1.05	0.15 ~0.30	0.15 ~0.30	≤0.025	≤0.020	≤0.25	0.35 ~0.50	≤0.08	
		GCr15	0.95 ~1.05	0.15 ~0.35	0.25 ~0.45	≤0.025	≤0.025	≤0.30	1.40 ~1.65	≤0.10	SUJ2
		GCr15SiMn	0.95 ~1.05	0.45 ~0.75	0.95 ~1.25	≤0.025	≤0.025	≤0.30	1.40 ~1.65	≤0.10	
		GCr15SiMo	0.95 ~1.10	0.65 ~0.85	0.20 ~0.40	≤0.027	≤0.020	≤0.30	1.40 ~1.70	0.30 ~0.40	
		GCr18Mo	0.95 ~1.05	0.20 ~0.40	0.25 ~0.40	≤0.025	≤0.020	≤0.25	1.65 ~1.95	0.15 ~0.25	

Table 13.2 Comparison table of main material components of each country (carburizing steel)

Country name	Standard name	Code	Main chemical composition (%)								Equivalent/ approximate steel of JIS		
			C	Si	Mn	P	S	Ni	Cr	Mo			
Japan	JIS G 4053 (2016)	SCr420	0.18 ~0.23	0.15 ~0.35	0.60 ~0.90	≤0.030	≤0.030	≤0.25	0.90 ~1.20	—			
		SCr435	0.33 ~0.38	0.15 ~0.35	0.60 ~0.90	≤0.030	≤0.030	≤0.25	0.90 ~1.20	—			
		SCM420	0.18 ~0.23	0.15 ~0.35	0.60 ~0.90	≤0.030	≤0.030	≤0.25	0.90 ~1.20	0.15 ~0.25			
		SCM435	0.33 ~0.38	0.15 ~0.35	0.60 ~0.90	≤0.030	≤0.030	≤0.25	0.90 ~1.20	0.15 ~0.30			
		SNCM420	0.17 ~0.23	0.15 ~0.35	0.40 ~0.70	≤0.030	≤0.030	≤0.25	1.60 ~2.00	0.40 ~0.60	0.15 ~0.30		
		SNCM815	0.12 ~0.18	0.15 ~0.35	0.30 ~0.60	≤0.030	≤0.030	4.00 ~4.50	0.70 ~1.00	0.15 ~0.30			
		USA	AISI A29/29M (2015) SAE J404 (2009)	5120	0.17 ~0.22	0.15 ~0.35	0.70 ~0.90	≤0.035	≤0.040	≤0.25	0.70 ~0.90	≤0.06	SCr420
				4118	0.18 ~0.23	0.15 ~0.35	0.70 ~0.90	≤0.035	≤0.040	≤0.25	0.40 ~0.60	0.08 ~0.15	SCM420
4135	0.33 ~0.38			0.15 ~0.35	0.70 ~0.90	≤0.035	≤0.040	≤0.25	0.80 ~1.10	0.15 ~0.25	SCM435		
4320	0.17 ~0.22			0.15 ~0.35	0.45 ~0.65	≤0.035	≤0.040	1.65 ~2.00	0.40 ~0.60	0.20 ~0.30	SNCM420		
8620	0.17 ~0.22			0.15 ~0.35	0.70 ~0.90	≤0.035	≤0.040	0.40 ~0.60	0.40 ~0.60	0.15 ~0.25	SNCM220		
AISI A29/29M(2015)	5135		0.33 ~0.38	0.15 ~0.35	0.60 ~0.80	≤0.035	≤0.040	≤0.25	0.80 ~1.05	≤0.06	SCr435		
AISI SAE AMS 6263M (2016)	9315		0.11 ~0.17	0.15 ~0.35	0.40 ~0.70	≤0.025	≤0.025	3.00 ~3.50	1.00 ~1.40	0.08 ~0.15	SNCM815		
France/ Germany	NF EN ISO 683-17 (2014) DIN EN ISO 683-17 (2014)		20Cr4	0.17 ~0.23	≤0.40	0.60 ~0.90	≤0.025	≤0.015	—	0.90 ~1.20	—	SCr420	
		20CrMo4	0.17 ~0.23	≤0.40	0.60 ~0.90	≤0.025	≤0.015	—	0.90 ~1.20	0.15 ~0.25	SCM420		
		20NiCrMo7	0.17 ~0.23	≤0.40	0.40 ~0.70	≤0.025	≤0.015	1.60 ~2.00	0.35 ~0.65	0.20 ~0.30			
		18NiCrMo14-6	0.15 ~0.20	≤0.40	0.40 ~0.70	≤0.025	≤0.015	3.25 ~3.75	1.30 ~1.60	0.15 ~0.25			
	NF EN 10084(2008) DIN EN 10084(2008)	17NiCrMo6-4	0.14 ~0.20	≤0.40	0.60 ~0.90	≤0.025	≤0.035	1.20 ~1.50	0.8 ~1.10	0.15 ~0.25			
	NF EN 10083-1 (1996) DIN EN 10083-1 (1996)	37Cr4	0.34 ~0.41	≤0.40	0.60 ~0.90	≤0.035	≤0.035	—	0.90 ~1.20	—	SCr435		
		25CrMo4	0.22 ~0.29	≤0.40	0.60 ~0.90	≤0.035	≤0.035	—	0.90 ~1.20	0.15 ~0.30	SCM420		
		34CrMo4	0.30 ~0.37	≤0.40	0.60 ~0.90	≤0.035	≤0.035	—	0.90 ~1.20	0.15 ~0.30	SCM435		
China		GB/T 3203 (1982)	G20CrMo	0.17 ~0.23	0.20 ~0.35	0.65 ~0.95	≤0.030	≤0.030	—	0.35 ~0.65	0.08 ~0.15		
	G20CrNiMo		0.17 ~0.23	0.15 ~0.40	0.60 ~0.90	≤0.030	≤0.030	0.40 ~0.70	0.35 ~0.65	0.15 ~0.30			
	G20CrNi2Mo		0.17 ~0.23	0.15 ~0.40	0.40 ~0.70	≤0.030	≤0.030	1.60 ~2.00	0.35 ~0.65	0.20 ~0.30	SNCM420		
	G20Cr2Ni4		0.17 ~0.23	0.15 ~0.40	0.30 ~0.60	≤0.030	≤0.030	3.25 ~3.75	1.25 ~1.75	—			
G10CrNi3Mo	0.08 ~0.13		0.15 ~0.40	0.40 ~0.70	≤0.030	≤0.030	3.00 ~3.50	1.00 ~1.40	0.08 ~0.15				
G20Cr2Mn2Mo	0.17 ~0.23		0.15 ~0.40	1.30 ~1.60	≤0.030	≤0.030	≤0.30	1.70 ~2.00	0.20 ~0.30				

Table 13.3 Chemical composition of high-speed steel

Standard		Chemical composition (%)											
		C	Si	Mn	P	S	Cr	Mo	V	Ni	Cu	Co	W
AMS	6491 (M50)	0.77 to 0.85	Max. 0.25	Max. 0.35	Max. 0.015	Max. 0.015	3.75 to 4.25	4.00 to 4.50	0.90 to 1.10	Max. 0.15	Max. 0.10	Max. 0.25	Max. 0.25
	5626	0.65 to 0.80	0.20 to 0.40	0.20 to 0.40	Max. 0.030	Max. 0.030	3.75 to 4.50	Max. 1.00	0.90 to 1.30	—	—	—	17.25 to 18.25
	2315 (M50NiL)	0.11 to 0.15	0.10 to 0.25	0.15 to 0.35	Max. 0.015	Max. 0.010	4.00 to 4.25	4.00 to 4.50	1.13 to 1.33	3.20 to 3.60	Max. 0.10	Max. 0.25	Max. 0.25

Table 13.4 Chemical composition of stainless steel

Standard	Code	Chemical composition (%)						
		C	Si	Mn	P	S	Cr	Mo
JIS G 4303	SUS440C	0.95 to 1.20	Max. 1.00	Max. 1.00	Max. 0.040	Max. 0.030	16.00 to 18.00	Max. 0.75
AISI	440C	0.95 to 1.20	Max. 1.00	Max. 1.00	Max. 0.040	Max. 0.030	16.00 to 18.00	Max. 0.75

Table 13.5 Comparison table of main material components of each country (machine structural carbon steel)

Country name	Standard name	Code	Main chemical composition (%)								Equivalent/approximate steel of JIS
			C	Si	Mn	P	S	Ni	Cr	Mo	
Japan	JIS G 4051 (2016)	S45C	0.42~0.48	0.15~0.35	0.60~0.90	≤0.030	≤0.035	≤0.20	≤0.20	—	S45C
		S53C	0.50~0.56	0.15~0.35	0.60~0.90	≤0.030	≤0.035	≤0.20	≤0.20	—	
		S55C	0.52~0.58	0.15~0.35	0.60~0.90	≤0.030	≤0.035	≤0.20	≤0.20	—	
USA	AISI A29/29M (2015) SAE J403 (2014)	1045	0.43~0.50	—	0.60~0.90	≤0.040	≤0.050	—	—	—	S45C
		1046	0.43~0.50	—	0.70~1.00	≤0.040	≤0.050	—	—	—	S45C
		1050	0.48~0.53	—	0.60~0.90	≤0.040	≤0.050	—	—	—	S50C
		1053	0.48~0.55	—	0.70~1.00	≤0.040	≤0.050	—	—	—	S53C
		1055	0.50~0.60	—	0.60~0.90	≤0.040	≤0.050	—	—	—	S55C
France/Germany	NF EN 10083-1,2 (2006) DIN EN 10083-1,2 (2006)	C45	0.42~0.50	≤0.40	0.50~0.80	≤0.045	≤0.045	≤0.40	≤0.40	≤0.10	S45C
		C45E	0.42~0.50	≤0.40	0.50~0.80	≤0.035	≤0.035	≤0.40	≤0.40	≤0.10	S45C
		C45R	0.42~0.50	≤0.40	0.50~0.80	≤0.035	0.02~0.04	≤0.40	≤0.40	≤0.10	S45C
		C55	0.52~0.60	≤0.40	0.60~0.90	≤0.045	≤0.045	≤0.40	≤0.40	≤0.10	S55C
		C55E	0.52~0.60	≤0.40	0.60~0.90	≤0.03	≤0.035	≤0.40	≤0.40	≤0.10	S55C
China	GB/T 24595 (2009) GB/T 699 (2015)	45	0.42~0.50	0.17~0.37	0.50~0.80	≤0.025	≤0.025	≤0.30	≤0.25	≤0.10	S45C
		50Mn	0.48~0.56	0.17~0.37	0.70~1.00	≤0.035	≤0.035	≤0.30	≤0.25	—	S53C
		55	0.52~0.60	0.17~0.37	0.50~0.80	≤0.035	≤0.035	≤0.30	≤0.25	—	S55C

Table 13.6 Physical property values of bearing materials

Steel type	Density ρ (g/cm ³)	Longitudinal elasticity factor E (GPa)	Linear expansion coefficient (×10 ⁻⁶ /°C)	Thermal conductivity (W/m·°C)	Specific heat (J/kg·°C)	Remarks
SUJ2	7.83	208	12.5	46	468	Quenching and tempering
SCr420	7.84	208	12.6	47	(470)	Quenching and tempering
SCM420	7.85	208	12.5	45	(470)	Quenching and tempering
SNCM420	7.85	208	12.0	44	(470)	Quenching and tempering
M50	7.85	210	11.4	25.0	460	Quenching and tempering
SUS440C	7.75	205	10.6	24.2	460	Quenching and tempering
SPCC	7.86	206	11.5	59	470	Annealing (not hard)
SUS304	7.93	193	17.3	16.3	500	Annealing
Chrome steel	7.84	206	11.2	42~50	465	0.09~0.25C, 0.55~1.5Cr
Special extra-mild steel	7.86	209	11.6	58.2	473	C<0.08
Extra-mild steel	7.86	206	11.4	58.7	475	0.08~0.12C
Mild steel	7.86	207	11.2	55.2	477	0.12~0.2C
Semi-hard steel	7.85	207	10.8	46.5	485	0.3~0.45C
Hard steel	7.84	205	10.7	44.1	489	0.4~0.5C
High carbon steel	7.82	201	10.2	40.1	510	0.8~1.6C
Mid carbon steel	7.8	202	10.7	38	460	0.5C
Silicon nitride	3.24	308	3.0	20	680	Si ₃ N ₄
Six-four brass	8.4~8.8	103~105	18.4~20.8	81~121	377~381	(Equivalent to CAC301)

Note: () indicates reference values.

Table 13.7 Mechanical property values of bearing materials

Steel type	Hardness (HV)	Yield point (MPa)	Tensile strength (MPa)	Elongation (%)	Reduction of area (%)	Charpy impact value (J/cm ²)	Remarks
SUJ2	700~750	(≥1176)	(≥1617)	≤0.5	—	(5~8)	Quenching and tempering
SCr420	250~340	—	≥830	≥14	≥35	≥49	Quenching and tempering
SCM420	275~370	(≥700)	≥930	≥14	≥40	≥59	Quenching and tempering
SNCM420	310~395	—	≥980	≥15	≥40	≥69	Quenching and tempering
SNCM815	330~395	—	≥1050	≥12	≥40	≥69	Quenching and tempering
SPCC	≤100	—	≥270	≥32~43	—	—	Annealing
SUS304	≤195	Proof stress ≥206	≥520	≥40	≥60	—	Annealing
S10C	115~160	≥206	≥314	≥33	—	—	900°C furnace cooling
S25C	130~190	≥265	≥411	≥27	—	—	850°C furnace cooling
S45C	175~240	≥343	≥569	≥20	—	—	Quenching and high-temperature tempering
S53C	190~270	≥392	≥647	≥15	—	—	Quenching and high-temperature tempering
Silicon nitride	1500	—	Bending ≥300	—	—	—	Si ₃ N ₄
Six-four brass	100~150	—	≥430	≥20	—	—	(Equivalent to CAC301)

Note: Mechanical properties are largely influenced by the sample size. () indicates reference values, and - indicates unknown values.

Table 13.8 Chemical composition of steel plate for pressed cages and carbon steel for machined cages

	Standard	Code	Chemical composition (%)						
			C	Si	Mn	P	S	Ni	Cr
Pressed steel cage	JIS G 3141	SPCC	—	—	—	—	—	—	—
	JIS G 3131	SPHC	—	—	—	Max. 0.050	Max. 0.050	—	—
	BAS 361	SPB2	0.13~0.20	Max. 0.04	0.25~0.60	Max. 0.030	Max. 0.030	—	—
	JIS G 4305	SUS304	Max. 0.08	Max. 1.00	Max. 2.00	Max. 0.045	Max. 0.030	8.00~10.50	18.00~20.00
Machined cage	JIS G 4051	S25C	0.22~0.28	0.15~0.35	0.30~0.60	Max. 0.030	Max. 0.035	—	—

Table 13.9 Chemical composition of high-strength cast brass for machined cages

Standard	Code	Chemical composition (%)							Impurities	
		Cu	Zn	Mn	Fe	Al	Sn	Ni	Pb	Si
JIS H 5120	CAC301	55.0 to 60.0	33.0 to 42.0	0.1 to 1.5	0.5 to 1.5	0.5 to 1.5	Max. 1.0	Max. 1.0	Max. 0.4	Max. 0.1

Table 13.10 Representative characteristics of resins used for cages

	Polyamide		Polyphenylene sulfide	Polyetheretherketone	Fabric-reinforced phenolic resin	
	66	46	PPS	PEEK		
Type	Crystalline thermoplastics	←	←	←	Thermosetting resin	
Melting point °C	265	295	285	343	—	
Glassy-transition temperature °C	66	78	88	143	—	
Maximum continuous operating temperature °C	120	150	230	260	—	
Price 1 (low) to 5 (high)	1	2	3	5	4	
Characteristics	Formability	◎	○	○	×	
	Toughness	◎	◎	△	○ to △	
	Strength	○	○	○	◎	△
	Oil resistance	○ to △	○ to △	◎	◎	○
	Moisture/water absorption	Large	Large	Slight	Slight	Small
Comprehensive evaluation	The property is generally stable.	The formability is slightly poor compared with polyamide 66, but the heat resistance is high.	The water absorbency is low, and the oil resistance and heat resistance are high.	Polyetheretherketone has properties necessary for cages but is expensive.	The lubricity is high, but complicated shapes cannot be machined.	
Applications	All-purpose	Temperature higher than polyamide 66	Applications that require oil resistance and heat resistance higher than polyamide	High-speed bearings for high-temperature and high-speed machine tools	High-speed angular contact ball bearings for machine tools	

Note: ◎ Excellen ○ Good △ OK × Poor

Table 13.11 Representative characteristics of rubber materials used for seals

Rubber type	Nitrile rubber	Acrylic rubber	Fluorinated rubber	
Abbreviation	NBR	ACM	FKM	
Characteristics	Elongation	○	△	
	Compression set	◎	×	○
	Wear resistance	◎	○	◎
	Aging resistance	○	◎	◎
	Weather and ozone resistance	△	◎	◎
	Water resistance	◎	△	◎
	Operating temperature range °C	-20 to 140	-15 to 150	-30 to 230
Comprehensive evaluation	The oil resistance, heat resistance, and wear resistance are high. It is widely used as rubber seals.	It is used at application temperature higher than that of NBR. It is easily swollen in ester oil. An ester-oil resistant grade is also available.	It is expensive. It has excellent heat resistance and chemical resistance but easily affected by urea grease.	

Table 13.12 Physical properties of shaft and housing materials

Parts	Material	Density ρ (g/cm ³)	Hardness (HV)	Longitudinal elasticity factor E(GPa)	Linear expansion coefficient (×10 ⁻⁶ /°C)	Thermal conductivity (W/m·°C)	Specific heat (J/kg·°C)	Remarks
Shaft	S25C	7.86	130	212	11.1	53	470	Annealing
	S45C	7.85	230	205	(11.9)	(41)	460	Thermal refining
	SS400	7.86	—	205	11.3	50	460	
	SCM415	7.85	300	200	11.0	42	460	Thermal refining
	SCM425	7.85	320	208	12.8	45	470	Thermal refining
	SCM440	7.85	340	205	12.0	41	460	Thermal refining
	SNCM439	7.85	340	208	12.0	44	470	Thermal refining
Housing	FC200	7.2	≥240	100	10~11	43	530	Gray cast iron
	FC250	7.3	≥250	100	10~11	41	530	
	FCD450	7.2	150~220	154	12.0	34	620	Spherical graphite cast iron
	FCD500	7.2	160~240	154	11.0	30	—	
	FCD700	7.2	190~320	154	10.0	26	—	
	ADC12	2.7	(HRB54)	71	21.0	96	(900)	Al-Si-Cu alloy
	SUS304	8.0	≤200	197	17.3	16	500	Austenitic stainless steel
	SUS410	7.8	≥170	204	10.8	(25)	460	Martensitic stainless steel
	SUS410L	7.8	(200)	204	10.8	(25)	—	Ferritic stainless steel

Note: Inequality signs indicate standard values. () indicates reference values.

Table 13.13 Mechanical properties of shaft and housing materials

Parts	Material	Hardness (HV)	Yield point (MPa)	Tensile strength (MPa)	Elongation (%)	Remarks
Shaft	S25C	180	≥270	≥440	≥27	Normalizing
	S45C	240	≥345	≥570	≥20	Normalizing
	SS400	—	(215)	≥400	≥17	Structural rolled steel
	SCM425	320	670	800	15	Thermal refining
	SCM440	340	835	980	17	Thermal refining
	SNCM439	340	900	980	18	Thermal refining
Housing	FC200	≤235	—	≥200	—	Separate casting sample Gray cast iron
	FC250	≤250	—	≥250	—	
	FCD350-22	≤160	≥220	≥350	≥22	Spherical graphite cast iron Separate casting sample
	FCD450-10	150~220	≥250	≥450	≥10	
	FCD500-7	160~240	≥320	≥500	≥7	
	FCD700-2	190~320	≥420	≥700	≥2	
	ADC12	(HRB54)	150	310	3.5	Al-Si-Cu alloy
	SUS304	≤200	(205)	(520)	≥40	Austenitic stainless steel
	SUS410	≥170	(345)	(540)	≥25	Martensitic stainless steel
	SUS410L	≤200	(195)	(400)	≥20	Ferritic stainless steel

Note: Inequality signs indicate standard values. () indicates reference values.

14. Shaft and housing design

Depending upon the design of a shaft or housing, the shaft may be influenced by an unbalanced load or other factors which can cause large fluctuations in bearing efficiency. For example, depending on the dimensional accuracy and shape accuracy of the shaft and housing, there could be insufficient interference fit with the bearing, leading to material creep during operation. When the machining accuracy of the shaft or the housing is insufficient or when there is an error in the installation, the inner ring or the outer ring of the bearing can become misaligned. Operation under this condition may cause excessive loading at the edges of the inner and outer rings as well as rolling elements, deteriorating the fatigue life. Furthermore, chipping damage may occur on the flange face of roller bearings due to heavy contact with the rolling element end surface while operating under misalignment. A speed differential between the rolling elements and cage may apply abnormal force to the cage, causing damage. For this reason, it is necessary to pay attention to the following when designing shaft and housing:

- (1) Bearing arrangement; most effective fixing method for bearing arrangement.
- (2) Selection of shoulder height and fillet radius of housing and shaft.
- (3) Shape precision and fitting dimensions; runout tolerance of shoulder area.
- (4) Machining precision and mounting error of housing and shaft suitable for allowable alignment angle and permissible misalignment of bearing.

When the housing rigidity is insufficient, excessive deformation of the inner and outer rings may lead to poor distribution of loading among rolling elements, causing abnormal noise and deterioration of fatigue life. Therefore, the housing requires sufficient rigidity.

When two or more bearings are to be attached to a shaft, one typically serves as a fixed end bearing and the other serves as a floating end bearing to compensate for axial mounting error and allow for thermal expansion. In addition, when two or more bearings are to be attached to a housing, the design must allow through hole machining to improve the accuracy of the housing.

14.1 Fixing of bearings

When a bearing that receives axial loads and preloads is to be attached to a shaft or a housing, an axial fixing method that is sufficient to withstand the axial loading such as a tightening nut, bolts, or snap rings should be selected because a serious problem may be caused when the raceway moves in the axial direction.

In addition, [solid type needle roller bearings](#)

[\(with inner ring\) and cylindrical roller bearings \(NU and N types\) that are to be mainly used as floating side bearings also need to be fixed in the axial direction because the raceway may move in the axial direction when the shaft is bent by a moment load, damaging the bearing.](#)

Table 14.1 shows general bearing fixing methods, and Table 14.2 shows fixing methods for bearings with tapered bores. See section “15. Bearing handling” for more information about bearing installation and removal.

Table 14.1 General bearing fixing methods

Inner ring clamp	Outer ring clamp	Snap ring
		
<p>The most common method of fixing bearings in place is to use clamping nuts or bolts to hold the shaft or housing abutment against the ring end face. The tightening nuts and bolts must be fixed so that they will not be loosened by axial loads or vibration when the bearing is being used.</p>		<p>Use of snap rings regulated under JIS B 2804, B 2805, and B 2806, makes for a very simple construction. However, interference with chamfers, bearing installation dimensions, and other related specifications must be considered carefully.</p> <p>Snap rings are not suitable for applications requiring high accuracy or where the snap ring receives large axial loads.</p>

Table 14.2 Fixing methods—bearings with tapered bores

Adapter sleeve mounting	Withdrawal sleeve mounting	Split ring mounting
		
<p>When installing bearings on cylindrical shafts, adapter sleeves or withdrawal sleeves can be used to fix bearings in place axially. The adapter sleeve is fastened in place by frictional force between the shaft and inner diameter of the sleeve.</p>		<p>For installation of tapered bore bearings directly on tapered shafts, the bearing is held in place by a split ring inserted into a groove on the shaft, and is fixed in place with a split ring nut or screw.</p>

14.2 Bearing fitting dimensions

14.2.1 Abutment height and fillet radius

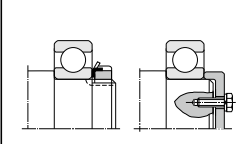
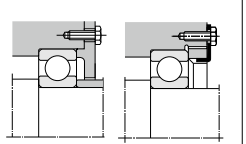
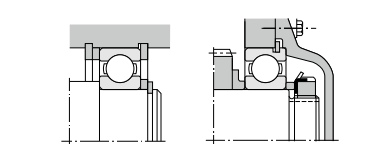
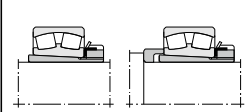
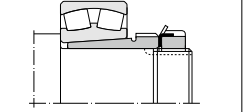
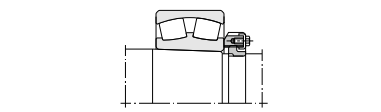
The shaft and housing **abutment height** (h) should be **larger than the bearings' maximum allowable chamfer dimensions** ($r_{s\ max}$), such that the abutment directly contacts the flat part of the bearing end face. The **fillet radius** (r_a) must be **smaller than the bearing's minimum allowable chamfer dimension** ($r_{s\ min}$) so that it does not interfere with bearing seating.

Table 14.3 lists abutment height (h) and fillet radius (r_a). For bearings to be subjected to very large axial loads, shaft abutments (h) should be higher than the values in the table.

Table 14.3 Fillet radius and abutment height

Unit: mm

$r_{s\ min}$	$r_{as\ max}$	h (Min.)	
		Normal use ¹⁾	Special use ²⁾
0.05	0.05	0.3	
0.08	0.08	0.3	
0.1	0.1	0.4	
0.15	0.15	0.6	
0.2	0.2	0.8	
0.3	0.3	1.25	1
0.6	0.6	2.25	2
1	1	2.75	2.5
1.1	1	3.5	3.25
1.5	1.5	4.25	4
2	2	5	4.5
2.1	2	6	5.5
2.5	2	6	5.5
3	2.5	7	6.5
4	3	9	8
5	4	11	10
6	5	14	12
7.5	6	18	16
9.5	8	22	20
12	10	27	24
15	12	32	29
19	15	42	38

1) If a bearing supports a large axial load, the height of the shoulder must exceed the value given here.
 2) Used when an axial load is light. These values are not suitable for tapered roller bearings, angular ball bearings and spherical roller bearings.
 Note: $r_{as\ max}$ indicates maximum allowable fillet radius.

14.2.2 For spacer and ground undercut

In cases where a fillet radius ($r_{a\ max}$) larger than the bearing chamfer dimension is required to strengthen the shaft or to relieve stress concentration (Fig. 14.1a), or abutment height is too low to afford adequate contact surface with the bearing (Fig. 14.1b), the use of a spacer may be beneficial.

Relief dimensions for ground shaft and housing fitting surfaces are given in Table 14.4.

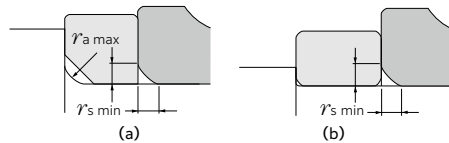
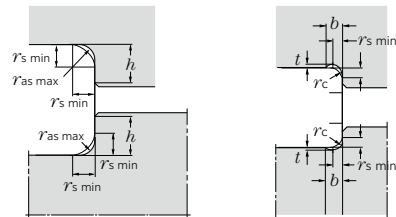

Fig. 14.1 Bearing mounting with spacer

Table 14.4 Relief dimensions for ground shaft

$r_{s\ min}$	Relief dimensions		
	b	t	r_c
1	2	0.2	1.3
1.1	2.4	0.3	1.5
1.5	3.2	0.4	2
2	4	0.5	2.5
2.1	4	0.5	2.5
2.5	4	0.5	2.5
3	4.7	0.5	3
4	5.9	0.5	4
5	7.4	0.6	5
6	8.6	0.6	6
7.5	10	0.6	7



14.2.3 Fitting dimensions for thrust bearings

For thrust bearings, it is necessary to make the raceway washer back face sufficiently wide in relation to load and rigidity. Consequently, fitting dimensions from the dimension tables should be adopted. (Figs. 14.2 and 14.3)

For this reason, **shaft and abutment heights will be larger than for radial bearings.** (Refer to dimension tables for all thrust bearing fitting dimensions.)

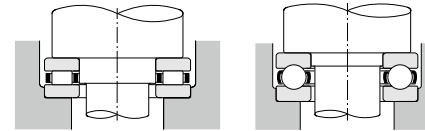

Fig. 14.2

Fig. 14.3

14.3 Shaft and housing accuracy

Table 14.5 shows the required accuracies for shaft and housing fitting surface dimensions and configurations, as well as fitting surface roughness and abutment squareness for normal operating conditions.

Table 14.5 Shaft and housing accuracy

Concern	Shaft	Housing
	Dimensional accuracy	IT6 (IT5)
Roundness (max.)	IT3	IT4
Cylindricity		
Abutment squareness	IT3	IT3
Fitting surface roughness R_a	Small size bearings	0.8
	Mid-large size bearings	1.6
		1.6

Note: For precision bearings (P4, P5 accuracy), it is necessary to improve the circularity and cylindricity accuracies in this table to approximately 50% of these values. For more specific information, please consult the **Precision rolling bearing catalog (CAT. No. 2260/E)**.

14.4 Bearing permitted inclination/ allowable alignment angle

A certain amount of misalignment of a bearing's inner and outer rings occurs as a result of shaft flexure, shaft or housing finishing irregularities, and minor installation error. In situations where the degree of misalignment is liable to be relatively large, **self-aligning ball bearings, spherical roller bearings, bearing units** and other bearings with aligning characteristics are advisable. Although permitted inclination and allowable alignment angle will vary according to bearing type, load conditions, internal clearances, etc., Table 14.6 lists some general misalignment standards for normal applications. In order to avoid shorter bearing life and cage failure, it is necessary to maintain levels of misalignment below these standard levels.

See section 3.7 (A-29) for the relationship between "Inclination angle (installation error) and life."

Table 14.6 Bearing types and allowable misalignment/allowable alignment angle

Allowable misalignment		
Deep groove ball bearings	1/1 000 to 1/300	Tapered roller bearings ¹⁾
Angular ball bearings ¹⁾		Single row standard 1/2 000
Single row	1/1 000	Single row ULTAGE 1/600
		Needle roller bearings 1/2 000
Cylindrical roller bearings		
Bearing series 10, 2, 3, 4	1/1 000	
Bearing series 22, 23	1/2 000	
ULTAGE	1/500	
Double row ²⁾	1/2 000	

1) The allowable misalignment of combined bearings is influenced by the load center position, so please consult NTN Engineering.
 2) Does not include high precision bearings for machine tool main shaft applications.

Note: For thrust bearings, please contact NTN Engineering.

Allowable alignment angle		
Self-aligning ball bearings	Normal load 1/15	Thrust spherical roller bearings 1/60 to 1/30
		Bearing units ³⁾ 1/60 to 1/30
Self-aligning roller bearings	Normal load 1/115 or more Light load 1/30	

3) For bearing units, see section "F. Bearing units" on page F-12.

15. Bearing handling

15.1 General information

Bearings are precision parts and in order to preserve their accuracy and reliability, care must be exercised in their handling. In particular, bearing cleanliness must be maintained, sharp impacts avoided, and rust prevented.

Bearings are vulnerable to impact. Do not hit them with a hammer directly or drop them on the floor. (Fig. 15.1)

In addition, bearings are sensitive to foreign particle contamination. When foreign particles enter the bearing during rotation, denting and/or scratches may occur, resulting in objectionable noise and vibration levels and rough bearing rotation (Fig. 15.2). Therefore, when handling bearings, it is necessary to keep the periphery clean.

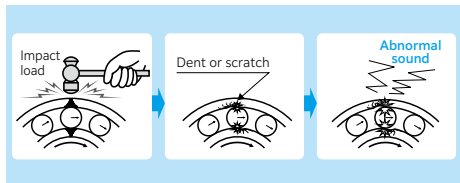

Fig. 15.1 Damage caused by impact

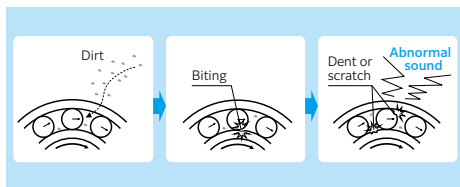

Fig. 15.2 Damage caused by foreign particle contamination

For optimal bearing performance, proper bearing handling methods must be used. The handling methods described herein are general guidelines. Depending on the type and size of bearing needed, special handling “methods” may be necessary. For more detailed information, please consult NTN Engineering.

Using proper protective equipment and tools

are also essential when installing or removing bearings, to avoid damage to the machinery and ensure the safety of the technician. Further information on proper installation and removal procedures is detailed in the following sections.

15.2 Bearing storage

Most rolling bearings are coated with a rust preventive oil before being packed and shipped. Please observe the following guidelines when storing bearings.

1. Ideally, bearings should be stored indoors at room temperature with a relative humidity of less than 60%. Avoid places in direct sunlight or in contact with outer walls because excessive temperature fluctuation or humidity rise may cause condensation.
2. Bearings should not be stored directly on the ground. Instead, they should be placed on a shelf or pallet at least 20 cm above the ground. The maximum number of shipping boxes to be stacked for storage should be limited to four whenever possible (Fig. 15.3).
3. Precision rolling bearings, large rolling bearings and thin ring or race rolling bearings must be laid down horizontally for storage (Fig. 15.4). Storing them standing vertically may cause raceway deformation. To avoid damage during transportation such as fretting or false brinelling, ensure that the individual bearing boxes are packed laying down horizontally within the shipping box. Fill remaining space with dunnage (Fig. 15.5).

Some products have a ↑ symbol on the shipping box to prevent improper storage placement. Follow the indication on the box in this case (Fig. 15.6).

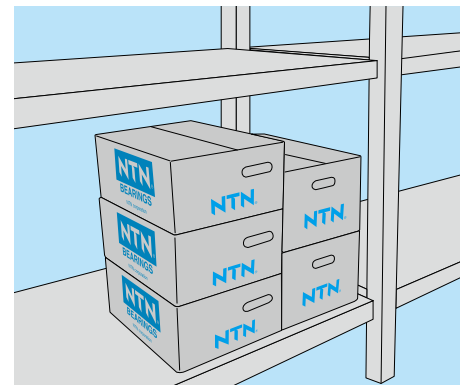

Fig. 15.3 Storing bearings on a shelf



Fig. 15.4 Storing one-bearing boxes on a shelf

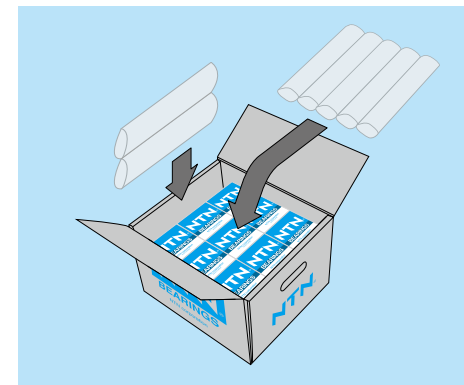

Fig. 15.5 Transportation and storage by shipping box

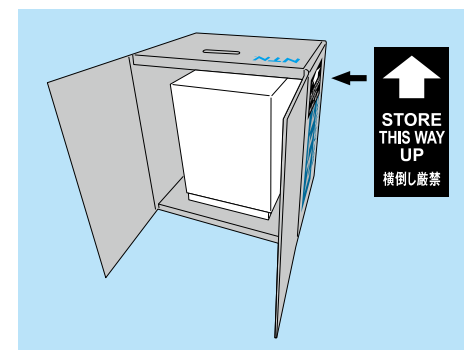

Fig. 15.6 Horizontally placing box prohibited

15.3 Bearing installation

A jig, a measuring instrument, a lubricant, and a clean and dry workshop will be needed for bearing installation. Further, if possible, it is desirable to install miniature/small ball bearings and precision rolling bearings in a clean room because intrusion of dirt and foreign matter significantly affects bearing performance.

Improper installation of bearings may cause marks from the rolling elements on the raceways, adversely affecting the bearing life. For the recommendations on machining accuracy and mounting accuracy of bearings, shafts, and housings, see section “14. Design of shafts and housings.”

15.3.1 Installation preparations

(1) Fitting surface of shafts and housings

When a bearing is installed on a shaft or in a housing with surfaces containing burrs or dents, the bearing may not seat properly, causing vibration and noise during operation (see Figs. 15.7 and 15.8).

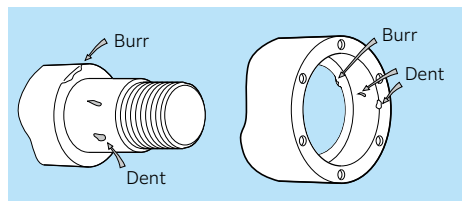

Fig. 15.7 Burrs and dents

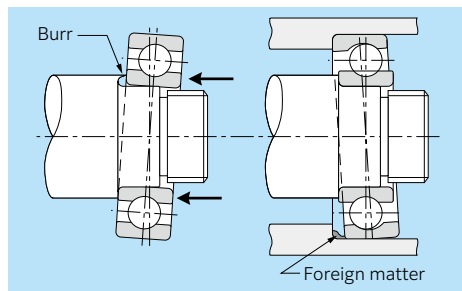

Fig. 15.8 Example of improper bearing installation

Therefore, before mounting bearings, remove any burrs, raised material near dents, rust, or dirt on the shaft, housing, or accessories. (Fig. 15.9)

The shaft and housing fitting surfaces should also be checked for roughness, dimensional and design accuracy, and to ensure that they are within allowable tolerance limits. Further, when the bearing is to be press-fitted, using an anti-fretting agent on the fitting surface improves the ease of assembly.

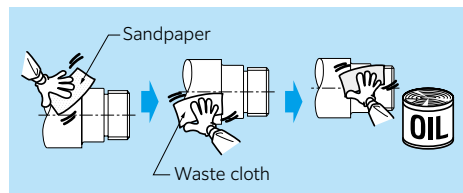

Fig. 15.9 Example of working procedure

(2) Mounting jig

The jig to be used for mounting must have a size suitable for the bearing and be free of dirt or damage.

(3) Opening of bearing

Bearings should be unpackaged directly before use to avoid introducing foreign particle contaminates or condensation which would lead to rust. Gloves should also be worn when handling bearings to avoid rust generation.

(4) Removal of rust preventative oil

In general, bearings with grease lubrication may be installed without cleaning the rust preventative oil.

However, for bearings using oil lubricant, or when lubrication efficiency would be compromised by mixing the grease and rust preventative oil, the rust preventative oil should be removed by washing with a cleaning solvent and dried before installation. The shield type bearings and the seal type bearings filled with grease must not be cleaned.

15.3.2 Installing cylindrical bore bearings

15.3.2.1 Press-fitting

Press-fitting is the most common mounting method and is widely used for small bearings. Bearings having a relatively small interference can be press-fitted by using a sleeve and applying force to the raceway at room temperature.

When press-fitting a bearing by applying impact with a hammer, use a resin or copper hammer rather than an iron one. To uniformly press the bearing onto the shaft or into the housing, use a sleeve. (Use of a mounting tool kit as shown in Fig. 15.40, A-168 is recommended.) Do not directly apply impact to bearing rings or press-fit them by using a punch because the bearings will not be press-fitted uniformly, causing bearing damage (Fig. 15.10).

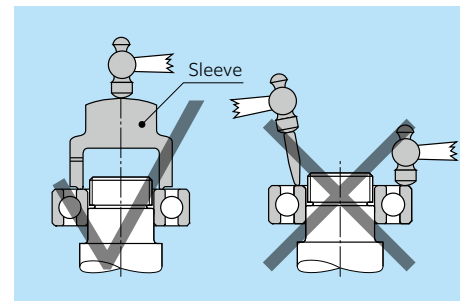

Fig. 15.10 Using hammer for press-fitting

When a large number of bearings are to be installed at one time, a dedicated jig or a hydraulic press may be used.

(1) Press-fitting bearing into shaft

Uniformly apply force by applying a sleeve to the inner ring width surface when press-fitting a bearing onto a shaft. Do not apply force to the outer ring as this will transfer the press force through the rolling elements which may cause dents or scratches on the raceway surface (Fig. 15.11).

When press-fitting self-aligning bearings, using a ring-shaped block as shown in Fig. 15.13 improves ease of installation.

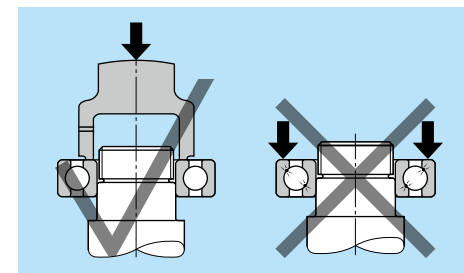

Fig. 15.11 Press-fitting bearing into shaft

(2) Press-fitting bearing into housing

Uniformly apply force by applying a sleeve to the outer ring width surface to press-fit a bearing into a housing. Do not apply force to the inner ring as this will transfer the press force through the rolling elements which may cause dents or scratches on the raceway surface (Fig. 15.12).

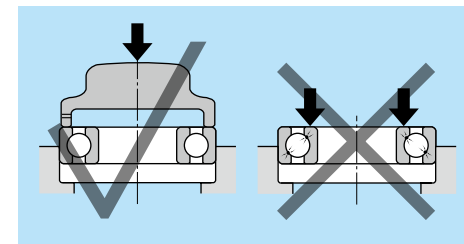

Fig. 15.12 Press-fitting bearing into housing

(3) Simultaneous press-fitting

When press-fitting a non-separable bearing such as a deep groove ball bearing onto the shaft and into the housing at the same time, use a ring-shaped block and uniformly apply force to inner and outer rings simultaneously. Do not apply force on either the inner or outer ring individually because it may cause dents or scratches on the raceway surface (Fig. 15.13).

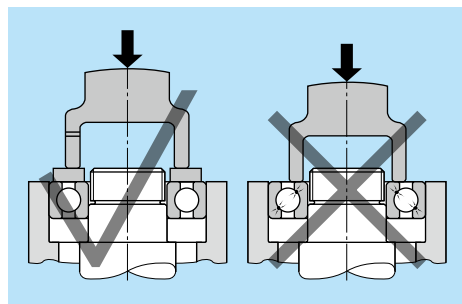

Fig. 15.13 Simultaneous press-fitting

[Caution]

- Excessive interference during installation may cause cracks and excessively small bearing internal clearance, resulting in seizure. For further detail, see section “7. Bearing fits.”
- Excessive impact at the time of installation may cause dents and damage.
- No foreign matter should enter the fitting surface during installation.
- For large interference fits and medium/large size bearings, consider other installation methods besides press-fitting at room temperature.

15.3.2.2 Heat fitting (shrink fitting)

When the inner ring interference is large or the bearing is large, press-fitting the inner ring onto the shaft at room temperature requires significant force. Heating the bearing and expanding the inner ring before installation makes the installation onto the shaft easier.

The inner ring expansion amount necessary for heat fitting can be obtained from the interference of the fitting surface between the inner ring and the shaft and the temperature difference before and after the bearing is heated (Fig. 15.14).

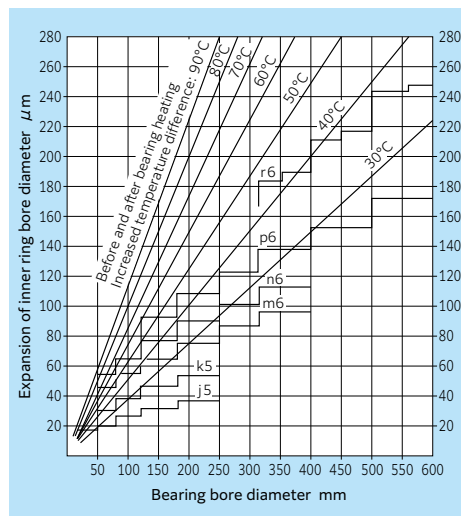

Fig. 15.14 Temperature required for heat-fitting inner ring

For heat fitting, any bearing that did not undergo dimension stabilization treatment **must not be heated above 120°C** to avoid permanent bearing damaged and shortened operating life. For sealed bearings, the seal temperature rating must not be exceeded.

In addition, **heat torches and heat guns should not be used for heating bearings** because the bearings may be heated non-uniformly and temperature control is difficult (Fig. 15.15).

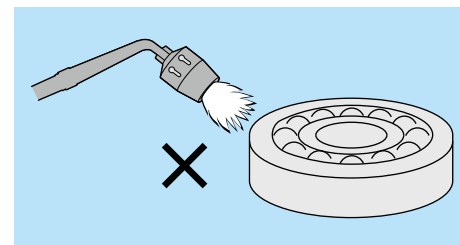

Fig. 15.15 Heating bearings by heat torch

The main methods used to heat bearings uniformly are (1) oil bath, (2) constant temperature oven, and (3) fast therm induction heater.

(1) Heating bearings in oil bath

One bearing heating method is immersing a bearing in a heated clean oil (Fig. 15.16). **Foreign particles are often found on the bottom of the oil bath; therefore, do not directly place bearings on the bottom of the oil bath. Instead, place the bearings on a wire rack or suspend it in the oil and then heat it. Shielded bearings and sealed bearings filled with grease must not be heated in the oil bath** (Fig. 15.17).

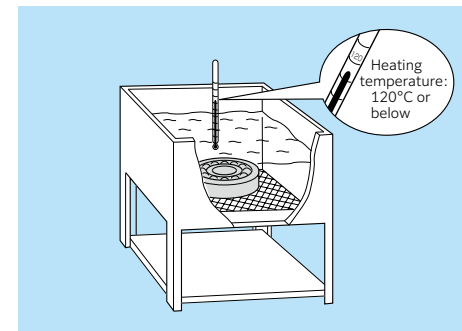

Fig. 15.16 Heating bearings in oil bath

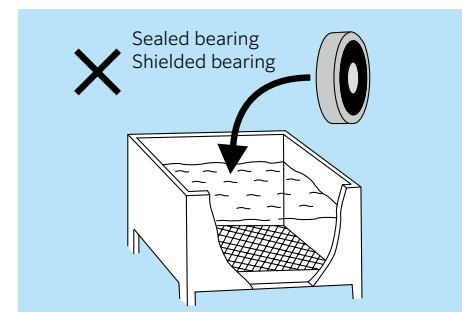

Fig. 15.17 Heating grease filled bearings in oil bath prohibited

(2) Heating bearings in constant temperature oven

With a constant temperature oven, bearings can be heated in a dry state (Fig. 15.18).

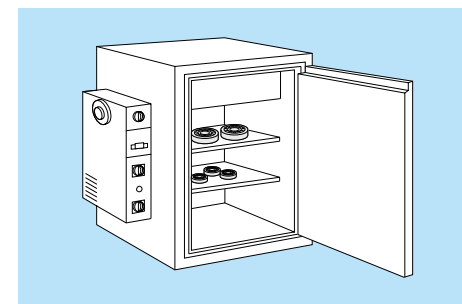

Fig. 15.18 Heating bearings in constant temperature oven

(3) Heating bearings with fast therm induction heater

With a fast therm induction heater, bearings can be heated safely, cleanly, and quickly in a dry state. **Heating bearings by induction heating makes the bearings magnetic; therefore, it is necessary to demagnetize bearings after heating.** The NTN fast therm induction heater (Fig. 15.42, A-168) has an automatic demagnetization function.

[Caution]

- Use heat-resistant gloves for safety when handling a heated bearing. NTN heat-resistant gloves optimal for bearing handling are available (Fig. 15.43, A-168).
- It is important to complete heat fitting quickly. If the bearing cannot be inserted onto the shaft during heat fitting, stop the process and consider removing the bearing.
- When heat fitting is performed, the inner ring contracts in the axial direction during cooling, creating a clearance between the bearing and the shaft shoulder (Fig. 15.19). Therefore, **it is necessary to tighten the bearing with a nut until it is completely cooled or apply a force in the axial direction while the bearing cools, to bring the bearing into close contact with the shoulder of the shaft.**

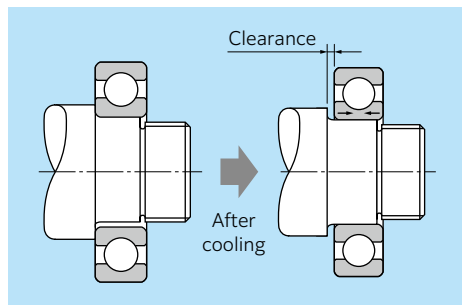

Fig. 15.19 Bearing contraction after heating

15.3.3 Installation of tapered bore bearing

Small tapered bore bearings are installed by inserting a bearing a predetermined amount with locknuts and by using a tapered bore or an adapter sleeve/withdrawal sleeve. Locknuts are tightened by a hook spanner wrench (Fig. 15.20).

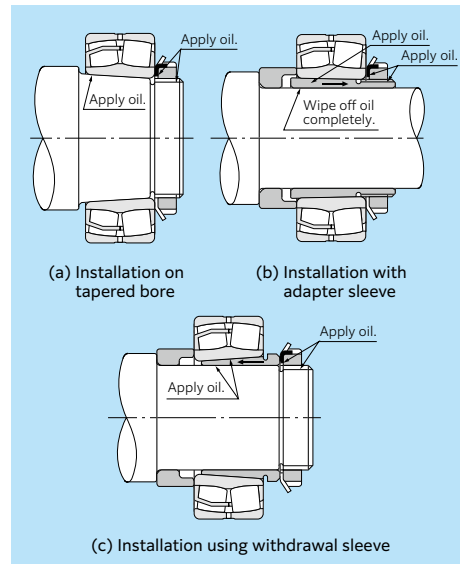

Fig. 15.20 Installation methods using locknuts

Large size bearings require considerable fitting force and must be installed hydraulically.

In Fig. 15.21 the fitting surface friction and nut tightening torque needed to install bearings with tapered bores directly onto tapered shafts are decreased by injecting high pressure oil between the fitting surfaces.

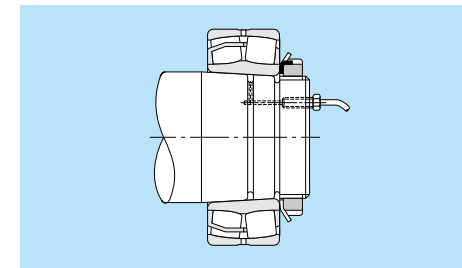

Fig. 15.21 Bearing installation using oil pressure

Fig. 15.22 (a) shows a method of installation where a hydraulic nut is used to drive the bearing onto a tapered shaft. Fig. 15.19 (b) and (c) show installation methods using a hydraulic nut with adapter sleeves and withdrawal sleeves.

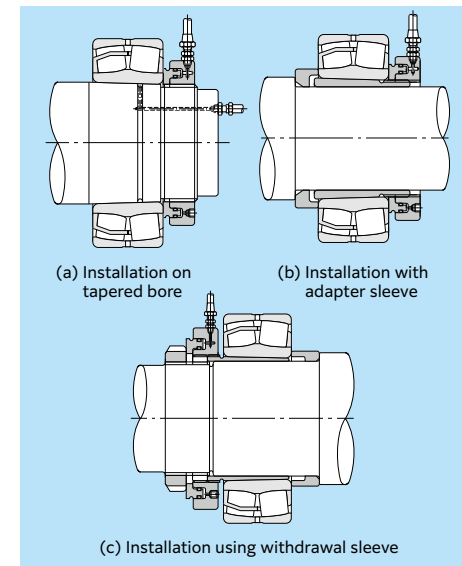

Fig. 15.22 Installation using hydraulic nut

Fig. 15.23 shows an installation method using a hydraulic withdrawal sleeve.

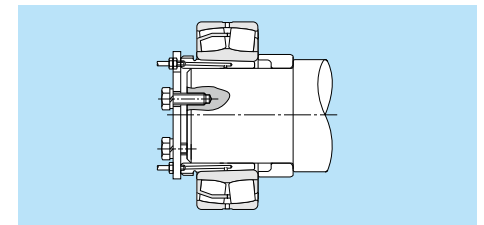

Fig. 15.23 Installation using hydraulic withdrawal sleeve

With tapered bore bearings, as the inner ring is driven axially onto the shaft, adapter or withdrawal sleeve, the interference increases so that the bearing radial internal clearance will decrease. Interference can be estimated by measuring the decrease in radial internal clearance. As shown in Fig. 15.24, the radial internal clearance between the rollers and outer ring of spherical roller bearings should be measured with a thickness gauge under no load while the rollers are held in the correct position. Measure the radial internal clearance on both rows, and check that the values are equivalent. Instead of using the decrease in amount of radial internal clearance to estimate the interference, it is possible to estimate the mounted radial internal clearance by measuring the distance the bearing has been driven onto the shaft.

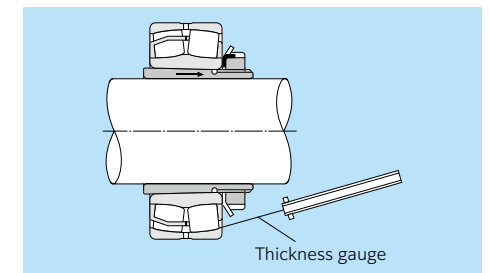

Fig. 15.24 Internal clearance measurement method for spherical roller bearings

For spherical roller bearings, **Table 15.1** (applied to ULTAGE series) and **Table 15.2** (applied to other bearings besides ULTAGE series) indicates the predetermined interference which will be achieved as a result of the radial internal clearance decrease, or the distance the bearing has been driven onto the shaft.

For conditions such as heavy loads, high speeds, or when there is a large temperature differential between inner and outer rings, etc. which require large interference fits, bearings with a minimum radial internal clearance of C3 or greater should be used. **Table 15.1** and **Table 15.2** list the maximum values for radial internal clearance decrease and axial displacement. The remaining clearance in mounted bearings with tapered bores must be greater than the minimum allowable residual clearance listed in **Table 15.1** or **Table 15.2**.

For self-aligning ball bearings, a predetermined interference can be obtained by tightening the nut until the radial internal clearance becomes about half the size before the fitting. After installation, check that the bearing lightly and smoothly rotates.

Table 15.1 Tapered bore spherical roller bearings (ULTAGE series installation)

Unit: mm

Nominal bearing bore diameter <i>d</i> mm		Reduction of radial internal clearance		Axial displacement drive up				Nut rotation angle ° (approx.)				Minimum residual radial internal clearance		
				Taper, 1:12		Taper, 1:30		Taper, 1:12		Taper, 1:30				
Over	Inc.	Min.	Max.	Min.	Max.	Min.	Max.	Min.	Max.	Min.	Max.	CN	C3	C4
24	30	0.010	0.015	0.15	0.20	—	—	36	48	—	—	0.015	0.025	0.040
30	40	0.015	0.020	0.25	0.30	—	—	60	72	—	—	0.015	0.030	0.045
40	50	0.020	0.025	0.35	0.40	—	—	84	96	—	—	0.020	0.035	0.055
50	65	0.025	0.030	0.40	0.45	—	—	72	81	—	—	0.025	0.045	0.065
65	80	0.035	0.040	0.50	0.60	—	—	90	108	—	—	0.030	0.055	0.080
80	100	0.040	0.050	0.60	0.70	—	—	108	126	—	—	0.030	0.060	0.090
100	120	0.055	0.065	0.80	0.90	1.80	2.30	144	162	324	414	0.035	0.070	0.105
120	140	0.065	0.075	0.90	1.00	1.95	2.70	162	180	351	486	0.045	0.085	0.125
140	150	0.075	0.090	1.00	1.20	2.35	3.10	180	216	423	558	0.040	0.090	0.140
150	160	0.075	0.090	1.00	1.20	2.35	3.10	120	144	282	372	0.040	0.090	0.140
160	180	0.080	0.100	1.10	1.40	2.80	3.55	132	168	336	426	0.040	0.100	0.160
180	200	0.090	0.110	1.20	1.50	3.20	3.95	144	180	384	474	0.050	0.110	0.180
200	225	0.110	0.130	1.50	1.80	3.85	4.60	135	162	347	414	0.050	0.120	0.190
225	250	0.120	0.140	1.60	1.90	4.20	4.95	144	171	378	446	0.060	0.130	0.210
250	280	0.130	0.160	1.60	2.10	4.25	5.40	144	189	383	486	0.060	0.140	0.230
280	305	0.150	0.180	1.90	2.40	4.45	5.70	171	216	401	513	0.060	0.150	0.250
305	315	0.150	0.180	1.90	2.40	4.45	5.70	137	173	320	410	0.060	0.150	0.250
315	355	0.160	0.190	2.10	2.50	5.10	6.10	151	180	367	439	0.080	0.170	0.280
355	400	0.180	0.220	2.30	3.00	5.75	7.50	166	216	414	540	0.080	0.180	0.300
400	450	0.210	0.250	3.00	3.60	—	—	216	259	—	—	0.080	0.190	0.320

Note: The nut rotation angle may only be applied when a nut having the same inner diameter code as the bearing is used.

Table 15.2 Tapered bore spherical roller bearings (installation of other series besides ULTAGE)

Unit: mm

Nominal bearing bore diameter <i>d</i> mm		Reduction of radial internal clearance		Axial displacement drive up				Nut rotation angle ° (approx.)				Minimum residual radial internal clearance		
				Taper, 1:12		Taper, 1:30		Taper, 1:12		Taper, 1:30				
Over	Inc.	Min.	Max.	Min.	Max.	Min.	Max.	Min.	Max.	Min.	Max.	CN	C3	C4
30	40	0.020	0.025	0.35	0.40	—	—	84	96	—	—	0.010	0.025	0.040
40	50	0.025	0.030	0.40	0.45	—	—	96	108	—	—	0.015	0.030	0.050
50	65	0.030	0.035	0.45	0.60	—	—	81	108	—	—	0.020	0.040	0.060
65	80	0.040	0.045	0.60	0.70	—	—	108	126	—	—	0.025	0.050	0.075
80	100	0.045	0.055	0.70	0.80	1.75	2.25	126	144	315	405	0.025	0.055	0.085
100	120	0.050	0.060	0.75	0.90	1.90	2.25	135	162	342	405	0.040	0.075	0.110
120	140	0.065	0.075	1.10	1.20	2.75	3.00	198	216	495	540	0.045	0.085	0.130
140	150	0.075	0.090	1.20	1.40	3.00	3.75	216	252	540	675	0.040	0.090	0.140
150	160	0.075	0.090	1.20	1.40	3.00	3.75	144	168	360	450	0.040	0.090	0.140
160	180	0.080	0.100	1.30	1.60	3.25	4.00	156	192	390	480	0.040	0.100	0.160
180	200	0.090	0.110	1.40	1.70	3.50	4.25	168	204	420	510	0.050	0.110	0.180
200	225	0.100	0.120	1.60	1.90	4.00	4.75	144	171	360	428	0.060	0.130	0.200
225	250	0.110	0.130	1.70	2.00	4.25	5.00	153	180	383	450	0.070	0.140	0.220
250	280	0.120	0.150	1.90	2.40	4.75	6.00	171	216	428	540	0.070	0.150	0.240
280	305	0.130	0.160	2.00	2.50	5.00	6.25	180	225	450	563	0.080	0.170	0.270
305	315	0.130	0.160	2.00	2.50	5.00	6.25	144	180	360	450	0.080	0.170	0.270
315	355	0.150	0.180	2.40	2.80	6.00	7.00	173	202	432	504	0.090	0.180	0.290
355	400	0.170	0.210	2.60	3.30	6.50	8.25	187	238	468	594	0.090	0.190	0.310
400	450	0.200	0.240	3.10	3.70	7.75	9.25	223	266	558	666	0.090	0.200	0.330
450	500	0.210	0.260	3.30	4.00	8.25	10.0	238	288	594	720	0.110	0.230	0.370
500	560	0.240	0.300	3.70	4.60	9.25	11.5	222	276	555	690	0.110	0.240	0.380
560	630	0.260	0.330	4.00	5.10	10.0	12.5	240	306	600	750	0.130	0.270	0.430
630	670	0.300	0.370	4.60	5.70	11.5	14.5	276	342	690	870	0.140	0.300	0.480
670	710	0.300	0.370	4.60	5.70	11.5	14.5	237	293	591	746	0.140	0.300	0.480
710	800	0.340	0.430	5.30	6.70	13.3	16.5	273	345	684	849	0.140	0.320	0.530
800	900	0.370	0.470	5.70	7.30	14.3	18.5	293	375	735	951	0.170	0.370	0.600
900	1 000	0.410	0.530	6.30	8.20	15.8	20.5	284	369	711	923	0.180	0.400	0.660
1 000	1 120	0.450	0.580	6.80	8.70	17.0	22.5	306	392	765	1 013	0.190	0.450	0.720
1 120	1 250	0.490	0.630	7.40	9.40	18.5	24.5	—	—	—	—	0.200	0.490	0.790

Note: The nut rotation angle may only be applied when a nut having the same inner diameter code as the bearing is used.

15.3.4 Installation of outer ring

With tight interference fits, the outer rings of small type bearings can be installed with a hydraulic press at room temperature. Alternately, the housing can be heated and expanded before installing the outer ring, or the outer ring can be cooled with a freezer, etc. before installing. If a freezer or another cooling agent is used, moisture will condense on bearing surfaces. Therefore appropriate rust preventative measures are necessary before cooling the bearing.

15.3.5 Internal clearance adjustment

As shown in Fig. 15.25, for angular contact ball bearings and tapered roller bearings the required amount of axial internal clearance can be set at the time of installation by tightening or loosening the adjustment nut.

To adjust the suitable axial internal clearance or amount of bearing preload, the internal clearance can be measured while tightening the adjusting nut as shown in Fig. 15.26. Another method is to check rotational torque by rotating the shaft or housing while adjusting the nut.

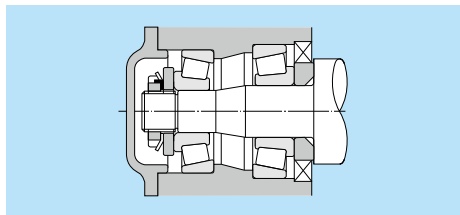

Fig. 15.25 Axial internal clearance adjustment

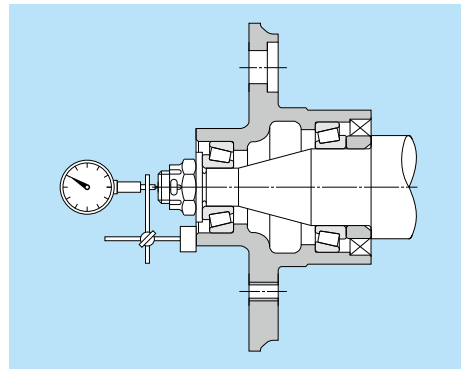

Fig. 15.26 Axial internal clearance measurement

A shim with appropriate thickness may also be used for adjusting the bearing internal clearance. Fig. 15.27 shows the case in which angular contact ball bearings are used in a face-to-face arrangement on the fixed side. A shim is inserted between the housing front cover and the housing shown by an arrow to change the fixed position of the outer ring.

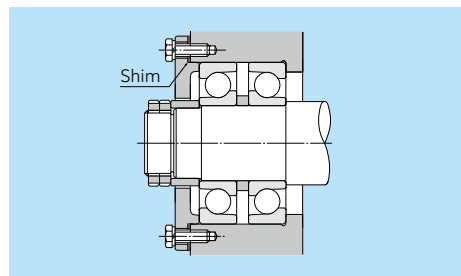

Fig. 15.27 Internal clearance adjustment using shims

15.4 Lubricant enclosure

An appropriate amount of lubricant that is suitable for the use condition of the bearing should be applied if the bearings are not pre-filled with grease. For details, see section "11. Lubrication."

15.5 Post installation running test

To check that the bearing has been properly installed, a running test is performed after installation is completed. The shaft or housing is first rotated by hand and if no problems are observed at low speed, a no-load power test should then be performed. **If no abnormalities are observed, the load and speed are gradually increased to operating conditions. During the test if any unusual noise, vibration, or temperature rise is observed, the test should be stopped and the equipment should be examined. If necessary, the bearing should be disassembled for inspection.**

15.6 Bearing disassembly

Bearings are often removed as part of periodic inspection procedures or during the replacement of other parts. However, the shaft and housing are almost always reinstalled, and in more than a few cases the bearings themselves are reused. These bearings, shafts, housings, and other related parts must be designed to prevent damage during disassembly procedures, and the proper disassembly tools must be employed. When removing bearing rings with interference, pulling force should be applied to the press fit bearing ring only. Do not remove the raceway through the rolling elements.

[Caution]

Bearings and jigs used for disassembly may fall off when the bearing is removed from the shaft or the housing.

15.6.1 Disassembly of bearings with cylindrical bores

For small sized bearings, pullers shown in Fig. 15.28 (a) and (b) or the press method shown in Fig. 15.29 can be used for disassembly. When used properly, these methods can improve disassembly efficiency and prevent damage to bearings.

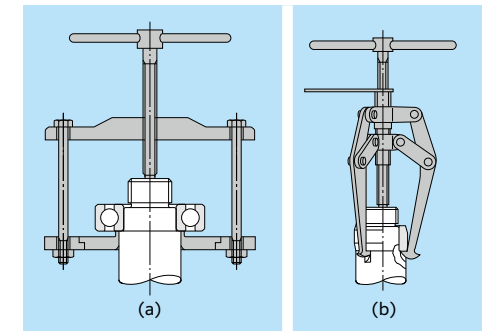

Fig. 15.28 Puller disassembly

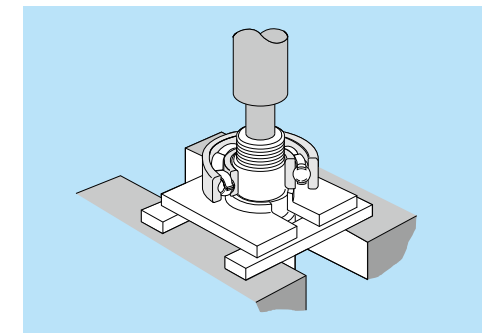

Fig. 15.29 Press disassembly

To facilitate disassembly procedures, attention should be given to planning the designs of shafts and housings, such as providing extraction grooves on the shaft and housing for puller claws as shown in **Figs. 15.30 and 15.31**. Threaded bolt holes could also be provided in housings to facilitate the pressing out of outer rings as shown in **Fig. 15.32**.

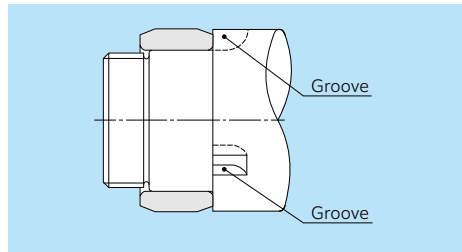

Fig. 15.30 Extracting grooves (example of three positions in circumferential direction)

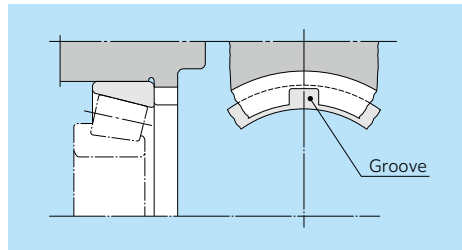

Fig. 15.31 Extraction groove for outer ring disassembly

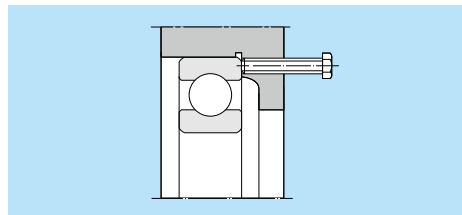

Fig. 15.32 Outer ring disassembly bolt

Large bearings, installed with tight fits, that have been in service for a long period of time, will likely have developed fretting on fitting surfaces and will require considerable dismantling force. In such instances, dismantling friction can be reduced by injecting oil under high pressure between the shaft and inner ring surfaces as shown in **Fig. 15.33**.

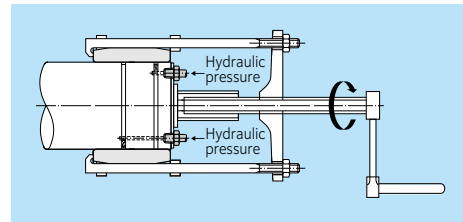

Fig. 15.33 Removal of bearing by hydraulic pressure

Induction heating can be used for removing the inner ring of cylindrical roller bearings having no flange on the inner ring such as NU type and NJ type bearings. With this method, the inner ring is heated until it expands, and can be removed (**Fig. 15.34**).

The bearing becomes magnetized by induction heating; therefore, it is necessary to demagnetize the bearing after heating.

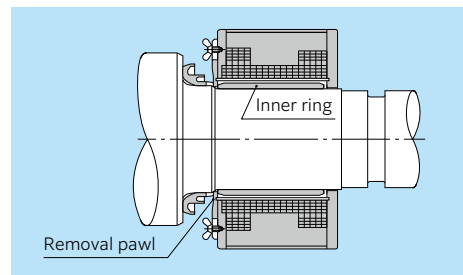

Fig. 15.34 Removal by induction heating

15.6.2 Disassembly of bearings with tapered bores

Small bearings installed using an adapter are removed by loosening the locknut, placing a block on the edge of the inner ring as shown in **Fig. 15.35 (a)** or the edge of the lock nut as shown in **Fig. 15.35 (b)**, and tapping it with a hammer. In such a case, use a resin or copper hammer instead of an iron one. Bearings which have been installed with withdrawal sleeves can be disassembled by tightening down the lock nut as shown in **Fig. 15.36**.

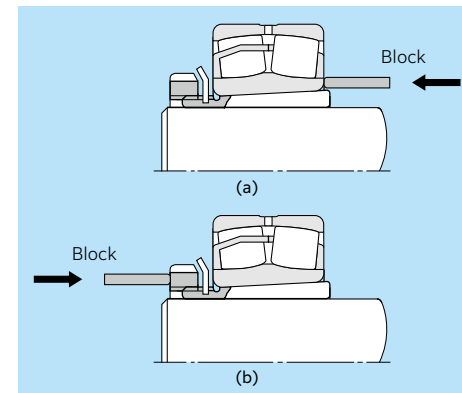

Fig. 15.35 Removal of bearing with adapter

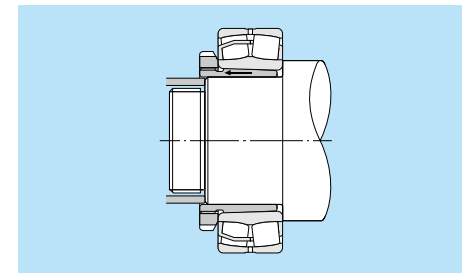

Fig. 15.36 Disassembly of bearing with withdrawal sleeve

For large type bearings on tapered shafts, adapters, or withdrawal sleeves, disassembly is greatly facilitated by hydraulic methods.

Fig. 15.37 shows the case where the bearing is

removed by applying hydraulic pressure on the fitting surface of a bearing installed on a tapered shaft.

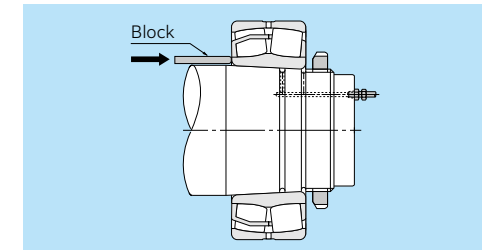

Fig. 15.37 Bearing disassembly using oil pressure

Fig. 15.38 shows two methods of disassembling bearings with adapters or withdrawal sleeves using a hydraulic nut. **Fig. 15.39** shows a disassembly method using a hydraulic withdrawal sleeve where high pressure oil is injected between fitting surfaces and a lock nut is then employed to remove the sleeve.

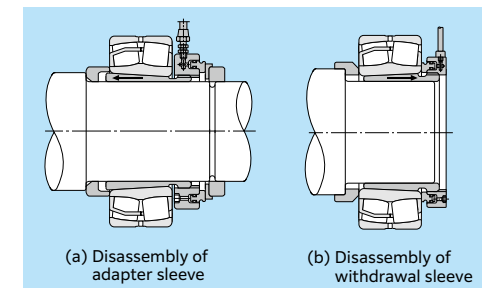

Fig. 15.38 Disassembly using hydraulic nut

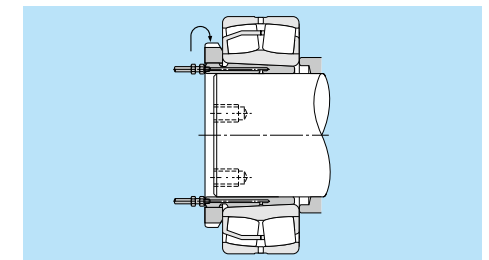

Fig. 15.39 Disassembly using hydraulic withdrawal sleeve

15.7 Bearing maintenance and inspection

Managing the condition of the machine during operation is important for preventing bearing failure. The following items are the general maintenance management methods.

(1) Inspection of machine while running

The interval for replenishing and replacing lubricant is determined by a study of lubricant properties and checking the bearing temperature, noise and vibration.

(2) Observation of bearing after use

Take note of any problem that may appear after the bearing is used or when performing routine inspections, and take measures for preventing reoccurrence of any damage discovered.

Maintenance management requires that the frequency for performing routine inspections be determined according to the importance of the device or machine.

15.7.1 Inspection of machine while running

15.7.1.1 Bearing temperature

In general, the bearing temperature increases after the start of operation and becomes steady at a slightly lower temperature after a certain time elapses (usually 10 to 40°C higher than the room temperature). The time until the temperature becomes steady differs depending on the bearing size, type, rotational speed, lubrication method, and heat dissipation condition of the bearing surroundings. It varies from 20 minutes to several hours.

When the bearing temperature does not become steady and rises excessively, the following may be the cause. Stop the operation and take measures.

<Main causes of abnormal temperature rise>

- Amount of lubricant too small or large
- Improper bearing installation
- Bearing internal clearance too small, or load too large
- Friction of sealing mechanism too large
- Unsuitable lubricant
- Creeping of fitting surface

The bearing temperature should not be too high to maintain suitable bearing operation and prevent the deterioration of lubricant. In general, it is best to use bearings at 100°C or below.

15.7.1.2 Bearing noise

To check bearing running noise, the sound can be checked and the type of noise can be ascertained with a listening instrument placed against the housing. A clear, smooth and continuous running sound is normal; however, determining the exact noise requires significant experience. Although it is difficult to express noise with words and it is different depending on the person, **Table 15.3** shows the characteristics and cause of the typical abnormal noises of bearings.

Table 15.3 Characteristics and cause of typical abnormal noise of bearings

Noise	Characteristics	Cause (probable)
Buzzing noise	—	<ul style="list-style-type: none"> • Entrance of foreign matter • Roughness of the surfaces of raceway, ball, roller • Scratches on the surfaces of raceway, ball, roller
Whoosh (small size bearings)	—	<ul style="list-style-type: none"> • Roughness of the surfaces of raceway, ball, roller
Short whoosh noise	<ul style="list-style-type: none"> • The noise is generated intermittently and regularly. 	<ul style="list-style-type: none"> • Contact with labyrinth part • Contact of case and seal
Rubbing noise/ rumbling noise	<ul style="list-style-type: none"> • The noise magnitude and pitch change when the rotational speed is changed. The noise becomes loud at a certain rotational speed. The noise becomes loud and quiet. The noise sometimes resembles the sound of sirens and whistles (howling noise). 	<ul style="list-style-type: none"> • Sympathetic vibration, fitting failure (shaft shape failure) • Deformation of raceway • Chattering noise of raceway, ball, roller (a little noise for large size bearings is normal)
Scraping noise/ crunchy noise	<ul style="list-style-type: none"> • Roughness felt when the bearing is rotated by hand 	<ul style="list-style-type: none"> • Scratches on the raceway surface (regular) • Scratches on the ball or roller (irregular) • Dirt, deformation of raceway (partial negative clearance)
Grumbling noise	<ul style="list-style-type: none"> • Continuous noise in high speed rotation 	<ul style="list-style-type: none"> • Scratches on the surfaces of raceway, ball, roller
Whirling noise	<ul style="list-style-type: none"> • The noise stops the moment the power is turned off. 	<ul style="list-style-type: none"> • Electromagnetic sound of motor
Clinking noise (mainly with small size bearings)	<ul style="list-style-type: none"> • Irregular • The noise does not change when the rotational speed is changed. 	<ul style="list-style-type: none"> • Entrance of foreign matter
Jingling noise (tapered roller bearings) Chattering noise (large size bearings) Flapping noise (small size bearings)	<ul style="list-style-type: none"> • The noise is regular and becomes continuous in high speed rotation. • Clear cage sound is normal. 	<ul style="list-style-type: none"> • Unsuitable lubricant (use soft grease for low temperature) • Cage pocket abrasion, insufficient lubricant, insufficient bearing load operation
Ticking noise/ clacking noise/ clattering noise	<ul style="list-style-type: none"> • Conspicuous in low speed rotation • Continuous noise in high speed rotation 	<ul style="list-style-type: none"> • Collision noise from cage pocket, insufficient lubrication. The noise stops by preloading or by making the internal clearance smaller. • Collision noise of rollers for the full component type
Clanging noise	<ul style="list-style-type: none"> • Loud metallic collision noise • Low-speed thin large size bearings 	<ul style="list-style-type: none"> • Deformation of raceway
Sliding noise/ squeaky noise splashing sound	<ul style="list-style-type: none"> • Mainly with cylindrical roller bearings, the noise changes when the rotational speed is changed. Large noise sounds like metallic sound. The noise temporarily stops when grease is supplied. 	<ul style="list-style-type: none"> • Lubricant (grease) consistency too high • Radial internal clearance too large • Insufficient lubricant
Squealing noise/ creaking noise/ whining noise	<ul style="list-style-type: none"> • Metal biting sound • High-pitched sound 	<ul style="list-style-type: none"> • Biting between roller and flange surface of roller bearing • Internal clearance too small • Insufficient lubricant
Splashing noise	<ul style="list-style-type: none"> • Occurs irregularly with small size bearings 	<ul style="list-style-type: none"> • Sound generated when bubbles in the grease are broken
Groaning noise/	<ul style="list-style-type: none"> • Irregular squeaky noise 	<ul style="list-style-type: none"> • Slippage of fitting part • Squeakiness of mounting surface
Indistinguishable loud noise during operation.		<ul style="list-style-type: none"> • Roughness of the surfaces of raceway, ball, roller • Deformation of raceway surface, ball, and roller caused by abrasion • Too large internal clearance caused by abrasion

15.7.1.3 Bearing vibration

Measuring the machine vibration during operation with a vibration measuring instrument can reveal bearing damage at an early stage. The bearing damage degree can be estimated by quantitatively measuring and analyzing the vibration amplitude and frequency. However, measurement values differ depending on the measurement positions and bearing use conditions. Therefore, it is desirable to accumulate measurement data and set criteria for each machine.

When the bearing is damaged, vibration including specific frequencies that depend on the bearing internal specifications and rotational speed occurs. The bearing vibration frequency can be calculated with the bearing technique calculation tool on the **NTN** website (<https://www.ntnglobal.com>).

15.7.1.4 Leakage/abnormal deterioration of lubricant

The main causes of the leakage/abnormal deterioration of lubricant are as follows. It is necessary to take measures depending on the use conditions and environment.

- Too much lubricant
- Unsuitable lubricant
- Improper installation
- Unsuitable sealing mechanism
- Deterioration caused by use
- Unsuitable operating condition
- Abnormal deterioration

15.7.2 Observation of bearing after use

Carefully observe bearings after use and during periodic inspection, and take appropriate recurrence prevention measures if any damage was found. For details, see section "16. Bearing damage and corrective measures."

15.8 Bearing maintenance tools

NTN offers maintenance tools for easily and safely installing/disassembling bearings. NTN also offers a portable abnormality detection device, a small vibration measurement device that has excellent portability and usability for measuring the vibration generated from the machine.

15.8.1 Maintenance tools

Figs. 15.40 through 15.49 show some of the main maintenance tools that are convenient for installing/disassembling bearings. For details, see the special catalog "Maintenance tools (CAT. No. 6600/J)."



The kit allows accurate, safe, and quick bearing installation.

Fig. 15.40 Cold mounting case



The five spanners allow tightening/loosening nuts of 30 different sizes.

Fig. 15.41 Hook spanners



The device allows safe and secure heat fitting work and has an automatic demagnetization function, an overheat prevention function, and a temperature maintaining function.

Fig. 15.42 Induction heater



The protective gloves allow safe handling of high-temperature bearings up to 350°C.

Fig. 15.43 Heat-resistant gloves



The tool allows simple and high precision measurement of bearing clearance.

Fig. 15.44 Set of calibrated feeler gauges



The jig allows quick and easy removal of bearings press-fitted into housings by a tight fit.

Fig. 15.45 Bore puller set



The jig allows safe and easy removal of bearings that are attached to shafts and difficult to remove.

Fig. 15.46 Back puller



The jig is a robust and simple tool for easily removing small and medium size bearings.

Fig. 15.47 Mechanical puller



The jig is efficient for easily and safely removing bearings press-fitted into shafts of large size bearings.

Fig. 15.48 Hydraulic puller



Removal can be done safely and efficiently by using the puller mechanically or hydraulically.

Fig. 15.49 Tri Section Pulling Plates

15.8.2 NTN PORTABLE VIBROSCOPE

NTN offers the "NTN PORTABLE VIBROSCOPE", a small vibration measurement device that has excellent portability and usability for performing FFT(Fast Fourier Transform) analysis and OA(Overall) measurement by wireless communication with tablets and smart devices with a dedicated application installed (Fig. 15.50).

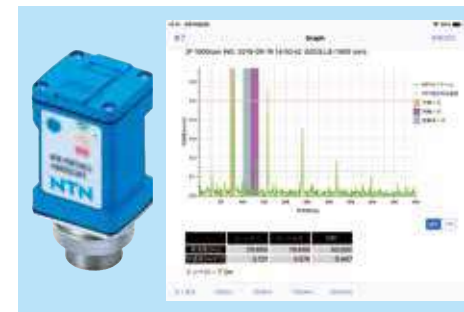

Fig. 15.50 NTN PORTABLE VIBROSCOPE

The FFT analysis clarifies the detailed operational state of the machine. By registering measurement conditions such as bearing part numbers and rotational speed, it is possible to detect the damage inside the bearing and estimate the damaged parts. In addition, selecting measurement conditions allows detecting abnormalities such as unbalance and misalignment of machines having rotating parts. In OA measurement, the acceleration, speed, and displacement can be displayed independently, and the measurement can be used as a general vibrometer.

The raw vibration data and the analysis results can be saved in smart devices for operation and can be downloaded in CSV format as necessary. In addition, the measurement device itself is dust-proof and drip-proof; therefore, the device is suitable for measuring vibration of machines used in various environments.

For the product details, please contact NTN Engineering.

For details, see the special catalog "NTN PORTABLE VIBROSCOPE (CAT. No. 6601/E)."

16. Bearing damage and corrective measures

16.1 Bearing damage, main causes of bearing damage, and remedies for correcting the problem

If handled correctly, bearings can generally be used for a long time before reaching their fatigue life. If damage occurs prematurely, the problem could stem from improper bearing selection, handling, or lubrication. If this occurs, take note of the application, operating conditions, and environment. By investigating several possible causes surmised from the type of damage and condition at the time the damage occurred, it is possible to prevent the same kind of damage from reoccurring. **Table 16.1** gives the main causes of bearing damage and remedies for correcting the problem.

For details, see the special catalog "Care and maintenance of bearings (CAT. No. 3017/E)."

Table 16.1 Bearing damage, main causes of bearing damage and remedies for correcting the problem

Phenomenon		
<p>Spalling (Flaking)</p> <p>The surface of the raceway and rolling elements peel away in flakes leaving a highly irregular and very poor surface.</p>  <ul style="list-style-type: none"> • Inner ring of spherical roller bearing • Flaking on one row of the raceway surface in this case. • An excessive axial load is the cause. • Outer ring of angular contact ball bearing • Flaking on the raceway surface with spacing equal to the distance between balls. • Improper handling is the cause. 	<p>Causes</p> <ul style="list-style-type: none"> • Excessive load, normal fatigue life, improper handling • Improper installation • Insufficient accuracy of shaft or housing • Insufficient clearance • Contamination • Rust • Insufficient lubrication • Reduction in hardness due to abnormal temperature rise <p>Correction</p> <ul style="list-style-type: none"> • Select a different type or size of bearing. • Reevaluate the clearance. • Improve the precision of the shaft and housing. • Improve assembly method and handling. • Reevaluate the layout (design) of the area around the bearing. • Review lubricant type and lubrication methods. 	
<p>Seizure</p> <p>Extreme thermal conditions eventually resulting in seizure of the bearing.</p>  <ul style="list-style-type: none"> • Inner ring of double-row tapered roller bearing • Seizure causes discoloration and softening, producing stepped abrasion on the raceway surface with spacing equal to the distance between the rollers. • Insufficient lubrication is the cause. • Inner ring of tapered roller bearing • Evidence of seizure on the large diameter side of raceway surface and large rib surface • Insufficient lubrication is one possible cause. 	<p>Causes</p> <ul style="list-style-type: none"> • Insufficient clearance (including clearances reduced by local deformation) • Insufficient lubrication or improper lubricant • Excessive loads (including excessive preload) • Roller skewing due to a misaligned bearing • Reduction in hardness due to abnormal temperature rise • High speed or large fluctuating load <p>Correction</p> <ul style="list-style-type: none"> • Review lubricant type and quantity. • Check for proper clearance. (Increase clearances.) • Take steps to prevent misalignment. • Improve assembly method and handling. 	
<p>Cracks/chips</p> <p>Localized flaking occurs. Little cracks or notches appear.</p>  <ul style="list-style-type: none"> • Inner ring of tapered roller bearing • Chipped large rib. • Impact due to improper preloading is the cause. • Outer ring of four-row cylindrical roller bearing • Cracks in the circumferential direction of raceway surface • These cracks were initiated by flaking. 	<p>Causes</p> <ul style="list-style-type: none"> • Excessive shock loads • Improper handling (use of steel hammer, damage from large particle contamination) • Formation of decomposed surface layer due to improper lubrication • Excessive interference • Flaking • Friction cracking • Imprecise mating component (oversized fillet radius) <p>Correction</p> <ul style="list-style-type: none"> • Review lubricant (friction crack prevention). • Select proper interference and review materials. • Improve assembly method and handling. 	

Table 16.1 (continued)



Phenomenon		
Cage damage Rivets break or become loose resulting in cage damage. Fracture of riveted steel cage at the corner radius.	 	Causes <ul style="list-style-type: none"> Excessive load or moment loading High speed or excessive speed fluctuations Insufficient lubrication Impact with foreign objects Excessive vibration Improper mounting (mounted misaligned)
<ul style="list-style-type: none"> Cage of angular contact ball bearing Breakage of high strength, machined brass cage Insufficient lubrication is the cause. 	<ul style="list-style-type: none"> Cage of cylindrical roller bearing Breakage of partitions between pockets of high strength, machined brass cage 	Correction <ul style="list-style-type: none"> Review lubricant type and lubrication methods. Review cage type selection. Investigate shaft and housing rigidity. Improve assembly method and handling.
Rolling path skewing Abrasion or an irregular, rolling path skewing due to rolling elements along raceway surfaces.	 	Causes <ul style="list-style-type: none"> Insufficient accuracy of shaft or housing Improper installation Insufficient shaft or housing rigidity Shaft whirling caused by excessive internal bearing clearances
<ul style="list-style-type: none"> Cage of deep groove ball bearing Breakage of riveted steel cage 	<ul style="list-style-type: none"> Cage of deep groove ball bearing Breakage at corner of riveted steel cage 	Correction <ul style="list-style-type: none"> Reevaluate the clearance. Improve the precision of the shaft and housing. Review rigidity of shaft and housing.
Smearing, Scuffing The surface becomes rough and some small deposits form. Scuffing generally refers to roughness on the race rib face and the ends of the rollers.	 	Causes <ul style="list-style-type: none"> Insufficient lubrication Contamination ingress Roller skewing due to a misaligned bearing Bare spots in the collar oil film due to large axial loading Excessive slippage of the rolling elements
<ul style="list-style-type: none"> Spherical roller bearing Uneven contact on inner ring, outer ring, and roller Improper installation is the cause. 	<ul style="list-style-type: none"> Roller of tapered roller bearing Evidence of uneven contact on rolling element surface 	Correction <ul style="list-style-type: none"> Review lubricant type and lubrication methods. Improve sealing performance. Review preload. Improve assembly method and handling.
<ul style="list-style-type: none"> Inner ring of cylindrical roller bearing Scuffing on the rib surface. 	<ul style="list-style-type: none"> Inner ring of cylindrical roller bearing Smearing on the raceway surface. The cause is slippage of rollers due to contaminants. 	

Table 16.1 (continued)

Phenomenon		
Rust/corrosion The surface becomes either partially or fully rusted, and occasionally rust occurs spaced at equal distances between rolling elements.	 	Causes <ul style="list-style-type: none"> Poor storage conditions Poor packaging Insufficient rust inhibitor Penetration by water, acid, etc. Handling with bare hands
<ul style="list-style-type: none"> Inner ring of tapered roller bearing Rust at equal distances between rolling elements on raceway surface. 	<ul style="list-style-type: none"> Outer ring of deep groove ball bearing Rust on the outer diameter surface. 	Correction <ul style="list-style-type: none"> Take measures to prevent rusting while in storage. Periodically inspect the lubricating oil. Improve sealing performance. Improve assembly method and handling.
Fretting There are two types of fretting. In one, a rusty wear powder forms on the mating surfaces. In the other, brinelling indentations form on the raceway corresponding to rolling element spacing.	 	Causes <ul style="list-style-type: none"> Insufficient interference Small bearing oscillation angle Insufficient lubrication Fluctuating loads Vibration during transport, or while stopped
<ul style="list-style-type: none"> Inner ring of cylindrical roller bearing Ripple-like fretting on the entire circumference of the raceway surface. Vibration is the cause. 	<ul style="list-style-type: none"> Inner ring of deep groove ball bearing Fretting on the entire circumference of the raceway surface. Vibration is the cause. 	Correction <ul style="list-style-type: none"> Review lubricant type and lubrication methods. Review the interference fit and apply a coat of lubricant to fitting surface. Pack the inner and outer rings separately for transport.
Wear The surfaces wear and dimensional deformation results. Wear is often accompanied by roughness and scratches.	 	Causes <ul style="list-style-type: none"> Entrapment of foreign particles in the lubricant Inadequate lubrication Roller skewing due to a misaligned bearing
<ul style="list-style-type: none"> Inner ring of cylindrical roller bearing Stepped wear on the entire circumference of the raceway surface. Insufficient lubrication is the cause. 	<ul style="list-style-type: none"> Cage of cylindrical roller bearing Wear of pocket part of high strength, machined brass cage 	Correction <ul style="list-style-type: none"> Review lubricant type and lubrication methods. Improve sealing performance. Take steps to prevent misalignment. Improve assembly method and handling.
Electrolytic corrosion Pits form on the raceway. The pits gradually grow into ripples.	 	Causes <ul style="list-style-type: none"> Electric current flowing through the rollers
<ul style="list-style-type: none"> Inner ring of deep groove ball bearing Ripple-like electrolytic corrosion on the raceway surface. 	<ul style="list-style-type: none"> The cross section of the electrolytic corrosion on the roller rolling element surface is enlarged (x400). The white layer shows up by nital etching of the cross section. 	Correction <ul style="list-style-type: none"> Create a bypass circuit for the current. Insulate the bearing.

Bearing Damage and Corrective Measures

Table 16.1 (continued)

Phenomenon		
<p>Dents and scratches</p> <p>Scoring during assembly, gouges due to hard foreign objects, and surface denting due to mechanical shock.</p>  <ul style="list-style-type: none"> • Roller of cylindrical roller bearing • Axial direction scratches on the rolling element surface at the time of preloading • Improper preloading is the cause. • Inner ring of tapered roller bearing • Dents on the entire raceway surface • Impact with hard foreign objects is the cause. 	<p>Causes</p> <ul style="list-style-type: none"> • Entrapment of hard foreign matter • Dropping or other mechanical shocks due to careless handling • Assembled misaligned • Excessive load or moment loading <p>Correction</p> <ul style="list-style-type: none"> • Improve assembly method and handling. • Improve sealing performance. (to prevent infiltration of foreign matter) • Check area surrounding bearing. (when caused by metal fragments) 	
<p>Creeping</p> <p>Surface becomes mirrored due to inner and outer diameter bearing surfaces spinning against the mating shaft or housing surface during operation. May be accompanied by discoloration or scoring.</p>  <ul style="list-style-type: none"> • Inner ring of deep groove ball bearing • Mirrored bore surface due to creeping on the shaft. • Inner ring of tapered roller bearing • Scuffing on bearing bore surface due to creeping on the shaft. 	<p>Causes</p> <ul style="list-style-type: none"> • Insufficient interference with mating component • Sleeve not fastened down properly • Abnormal temperature rise • Excessive loads • High speed/rapid acceleration or deceleration <p>Correction</p> <ul style="list-style-type: none"> • Reevaluate the interference fit. • Review operating conditions. • Improve the precision of the shaft and housing. • Fix of the faces of inner/outer ring 	
<p>Speckles and discoloration</p> <p>Luster of raceway surfaces is gone; surface is matted, rough, and / or evenly dimpled. Surface covered with minute dents.</p>  <ul style="list-style-type: none"> • Inner ring of double-row tapered roller bearing • Speckles and discoloration on the raceway surface. • Electrolytic corrosion is the cause. • Ball of deep groove ball bearing • Large speckles and discoloration • Impact with hard foreign objects and insufficient lubrication are the cause. 	<p>Causes</p> <ul style="list-style-type: none"> • Infiltration of bearing by foreign matter • Insufficient lubrication <p>Correction</p> <ul style="list-style-type: none"> • Review lubricant type and lubrication methods. • Review sealing mechanisms. • Examine lubrication oil purity. (filter may be excessively dirty, etc.) 	
<p>Peeling</p> <p>Patches of minute flaking or peeling (size, approx. 10 μm). Innumerable hair-line cracks visible though not yet peeling. (This type of damage is frequently seen on roller bearings.)</p>  <ul style="list-style-type: none"> • Spherical rollers • Linear peeling on the rolling element surface. • Insufficient lubrication is the cause. • Outer ring of deep groove ball bearing • Peeling on the load zone of the raceway surface. 	<p>Causes</p> <ul style="list-style-type: none"> • Infiltration of bearing by foreign matter • Insufficient lubrication <p>Correction</p> <ul style="list-style-type: none"> • Review lubricant type and lubrication methods. • Improve sealing performance. (to prevent infiltration of foreign matter) • Perform run-in. 	

Bearing Damage and Corrective Measures

Table 16.2 gives the main causes of bearing damage. In the table, factors that are likely to be the cause of each damage are marked by ○; however, factors without ○ may be the cause of the damage in special circumstances.

Table 16.2 Bearing damage and causes

Bearing damage	Damaged parts	Causes															
		Handling	Bearing periphery	Lubrication	Load	Speed	Bearing selection										
		Poor storage condition/ vibration during transportation	Improper handling/ installation	Insufficient accuracy of shaft/housing	Infiltration of bearing by foreign matter (insufficient sealing performance)	Temperature (heat effect)	Lubricant (insufficient/improper quality)	Lubrication method (insufficient)	Load/preload	Excessively large moment	Excessively small load	High speed/rapid acceleration and deceleration	Large vibration	Swinging/vibration/standstill	Excessively large/small clearance	Excessively large/small interference	
Flaking (separation)	Raceway surface/rolling element surface		○	○	○	○	○	○	○							○	
Seizure	Raceway/rolling element/cage		○			○	○	○	○	○						○	
Cracks/chips	Raceway/rolling element		○	○			○	○	○	○							○
Cage damage	Rivets break or become loose		○		○	○	○	○	○								
Rolling path skewing	Raceway surface		○	○												○	
Smearing/scuffing	Raceway surface/rolling element surface/rib surface/roller end surface		○		○	○	○	○	○		○						
Rust/corrosion	Rust on a part of or the entire surface of the rolling element pitch	○	○		○	○	○										
Fretting	Red rust on fitting surface		○						○					○			
	Brinelling indentations form on the raceway of the rolling element pitch	○				○	○								○		○
Wear	Raceway surface/rolling element surface/rib surface/roller end surface		○		○	○	○										
Electrolytic corrosion	Pits form on the raceway. The pits gradually grow into ripples.		○														
Dents and scratches	Raceway surface/rolling element surface		○		○				○	○							
Creeping	Fitting surface		○	○		○			○								○
Speckles and discoloration	Raceway surface/rolling element surface				○	○	○										
Peeling	Raceway surface/rolling element surface				○	○	○										

16.2 Rolling paths and how load is applied

When a bearing rotates in response to a load, the raceway surfaces of the inner and outer rings develop a hazy rolling path due to rolling contact with the rolling element. The rolling path on the raceway surface is normal. Evaluation of the rolling path of a used bearing can provide the engineer with useful information regarding the conditions the bearing had been exposed to.

Rolling path observation clarifies if a radial load was applied, an axial load was applied, or a moment load was applied. It can also show if the bearing experienced a large load or a mounting error. These observations provide extremely important references when determining the cause of bearing damage.

Figure 16.1 shows rolling paths of point and linear contacts caused under various load conditions.

(1) is a general rolling path generated when a radial load is applied to a bearing with inner ring rotation. The width of the rolling path becomes small at the entrance of the load zone of the outer ring, which is the fixed side. On the other hand, (2) shows a rolling path pattern opposite to (1) when a radial load is applied during outer ring rotation. (3) is a rolling path generated when an axial load in one direction is applied to a bearing, and an example of linear contact on a spherical roller bearing. When a combined load is applied during inner ring rotation, a rolling path pattern such as (4) is caused. As shown in (5), when a radial load is applied to a bearing with significant misalignment due to a moment load, rolling paths are generated at two positions separated by 180 degrees in the load zone of the outer ring, which is the fixed side. (6) shows the case where the housing bore diameter is an ellipse. Rolling paths are left on the fixed side outer ring at two positions but are not misaligned. (5) and (6) indicate improper bearing use, and the bearing life may be shorter because of the adverse effect.

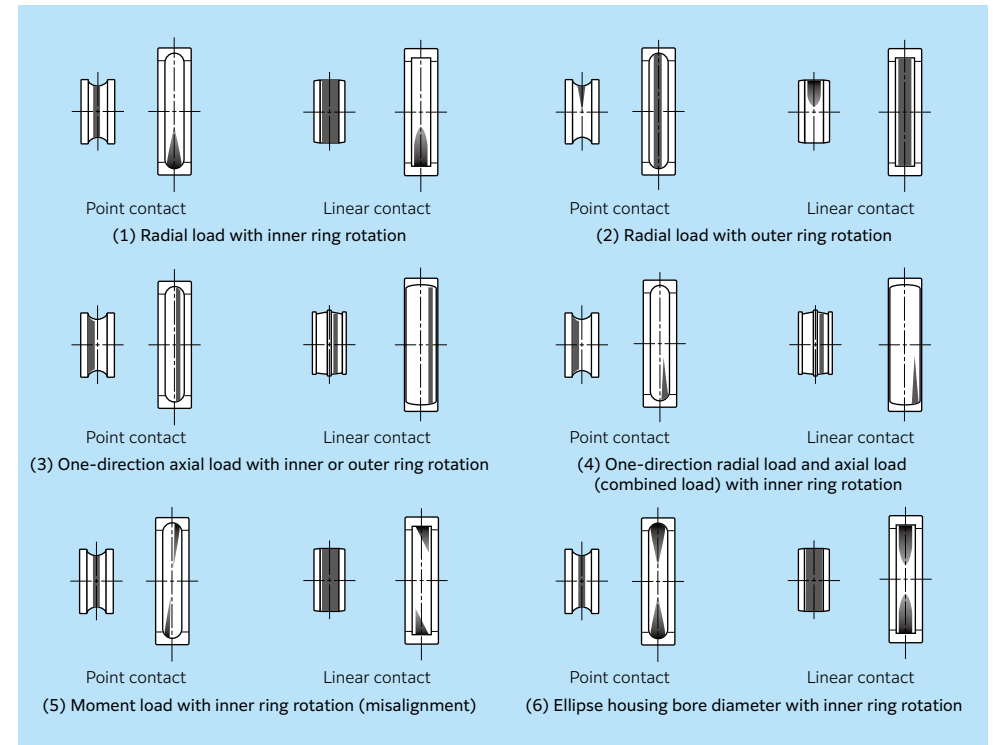

Figure 16.1 Rolling paths and how load is applied

*This technical data shows calculated values based on representative values, NTN does not guarantee these values.

17. Technical data

17.1 Radial internal clearances vs. axial internal clearances

17.1.1 Deep groove ball bearings

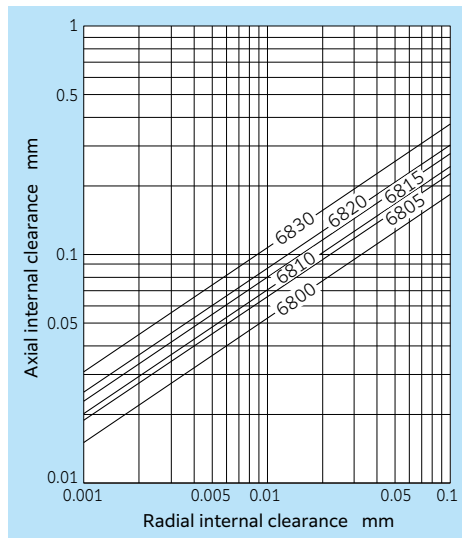

Fig. 17.1.1 Series 68 radial internal/axial internal clearances

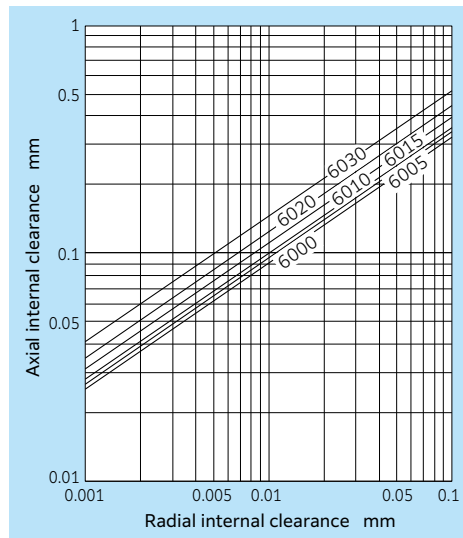

Fig. 17.1.3 Series 60 radial internal/axial internal clearances

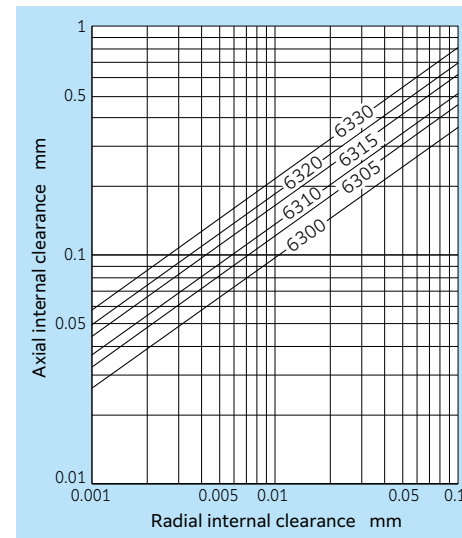

Fig. 17.1.5 Series 63 radial internal/axial internal clearances

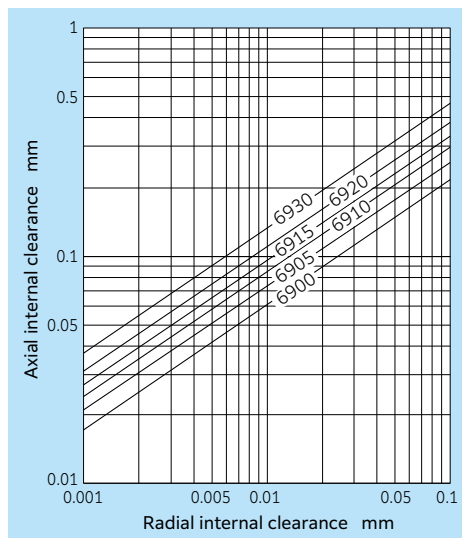

Fig. 17.1.2 Series 69 radial internal/axial internal clearances

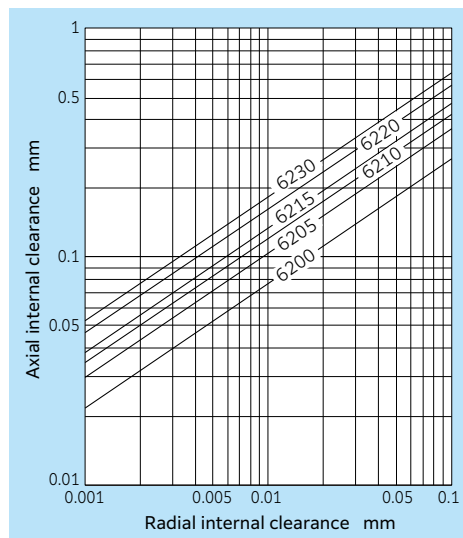

Fig. 17.1.4 Series 62 radial internal/axial internal clearances

Note: Please consult NTN Engineering for other types and sizes.

*This technical data shows calculated values based on representative values, NTN does not guarantee these values.

Note: Please consult NTN Engineering for other types and sizes.

*This technical data shows calculated values based on representative values, NTN does not guarantee these values.

17.1.2 Double-row angular contact ball bearings

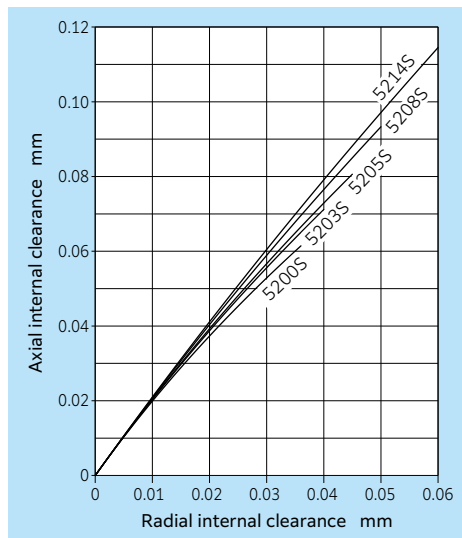

Fig. 17.1.6 Series 52S radial internal/axial internal clearances

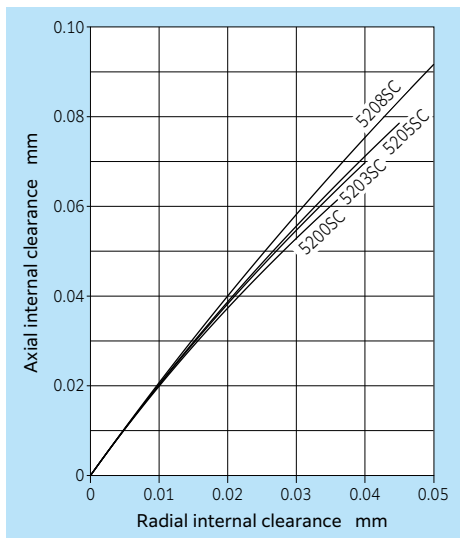

Fig. 17.1.8 Series 52SC radial internal/axial internal clearances

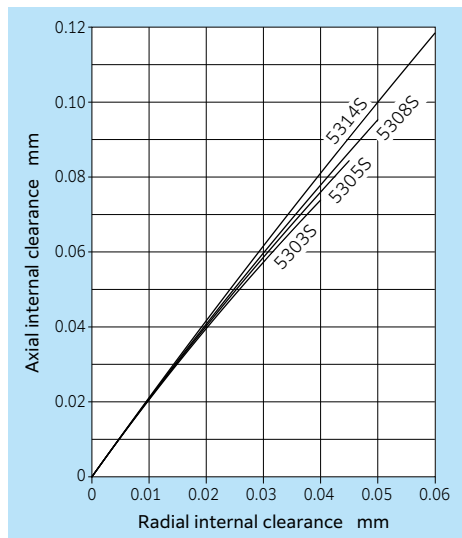

Fig. 17.1.7 Series 53S radial internal/axial internal clearances

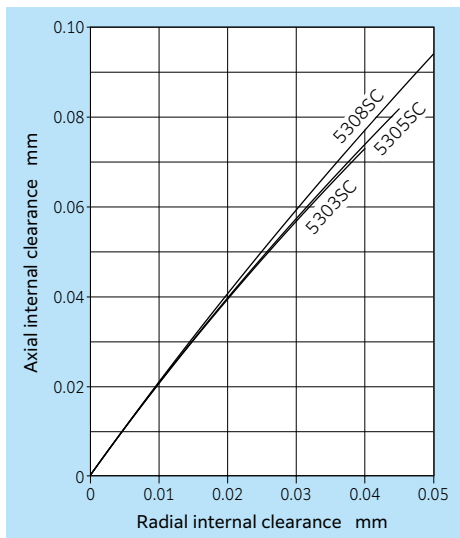

Fig. 17.1.9 Series 53SC radial internal/axial internal clearances

Note: Please consult NTN Engineering for other types and sizes.

*This technical data shows calculated values based on representative values, NTN does not guarantee these values.

17.1.3 Spherical roller bearings

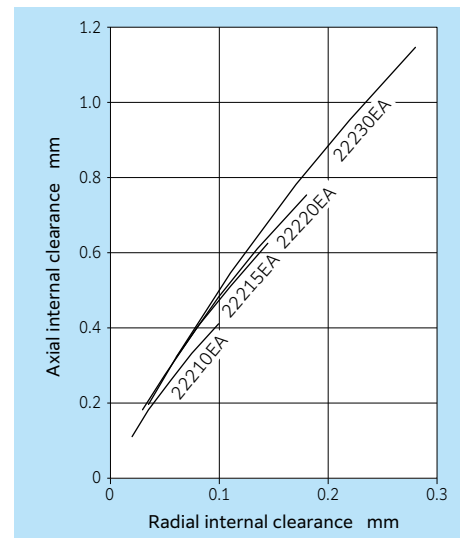

Fig. 17.1.10 Series 222 radial internal/axial internal clearances

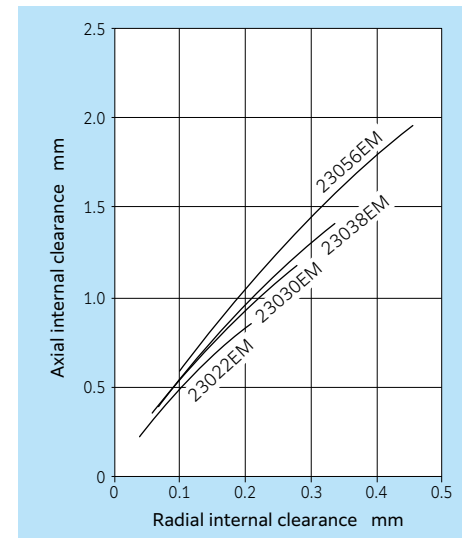

Fig. 17.1.12 Series 230 radial internal/axial internal clearances

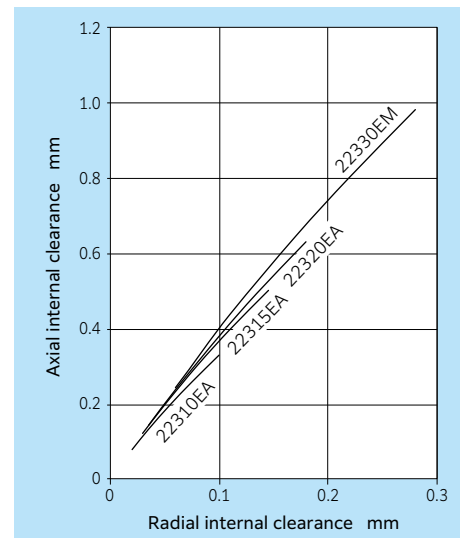

Fig. 17.1.11 Series 223 radial internal/axial internal clearances

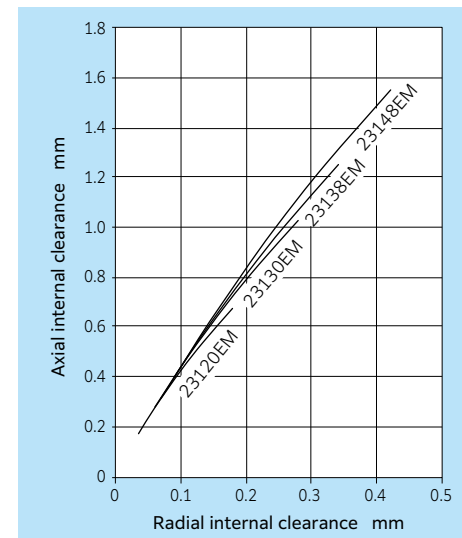

Fig. 17.1.13 Series 231 radial internal/axial internal clearances

Note: Please consult NTN Engineering for other types and sizes.

*This technical data shows calculated values based on representative values, **NTN** does not guarantee these values.

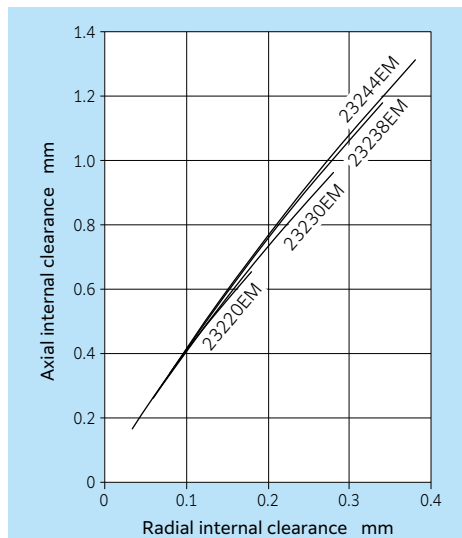

Fig. 17.1.14 Series 232 radial internal/axial internal clearances

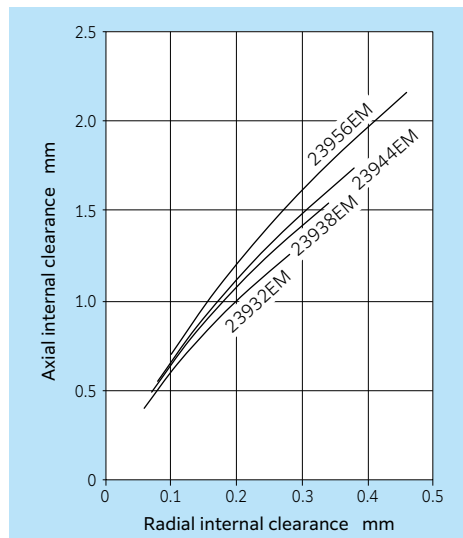

Fig. 17.1.15 Series 239 radial internal/axial internal clearances

Note: Please consult **NTN** Engineering for other types and sizes.

*This technical data shows calculated values based on representative values, **NTN** does not guarantee these values.

17.2 Axial load vs. axial displacement

17.2.1 Angular contact ball bearings

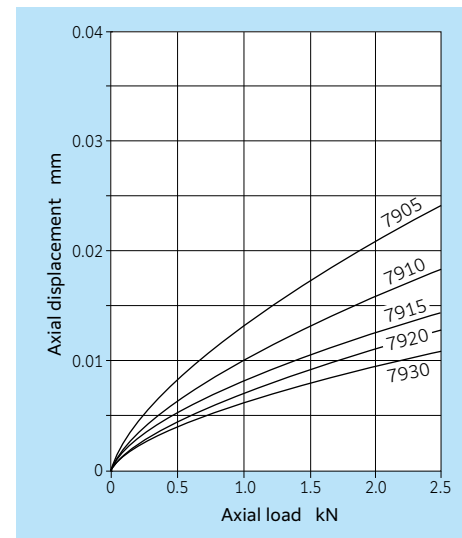

Fig. 17.2.1 Series 79 axial load vs. axial displacement

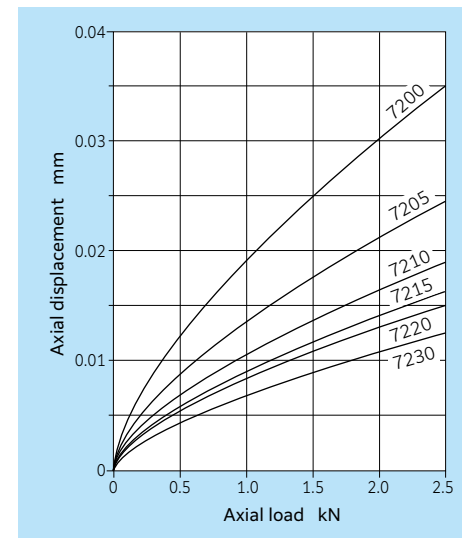

Fig. 17.2.3 Series 72 axial load vs. axial displacement

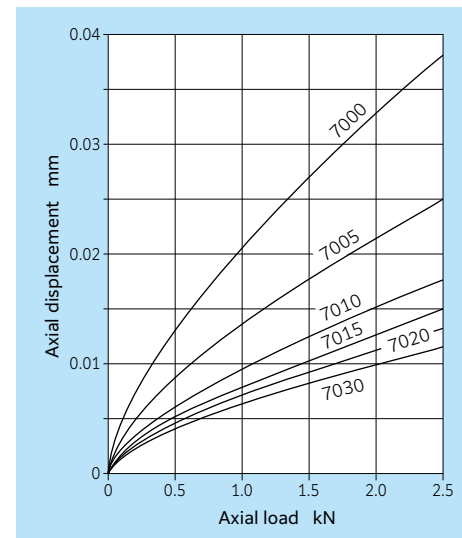

Fig. 17.2.2 Series 70 axial load vs. axial displacement

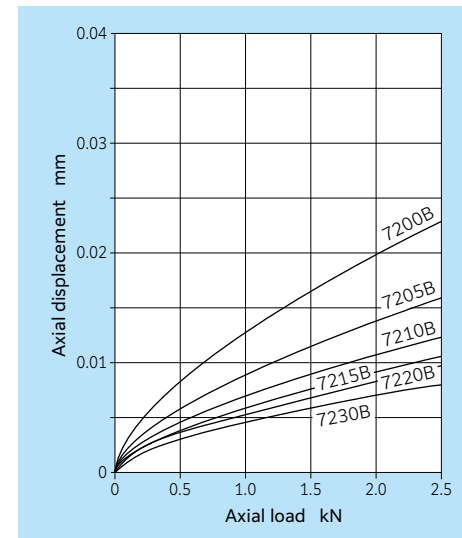

Fig. 17.2.4 Series 72 B axial load vs. axial displacement

Note: Please consult **NTN** Engineering for other types and sizes.

*This technical data shows calculated values based on representative values, **NTN** does not guarantee these values.

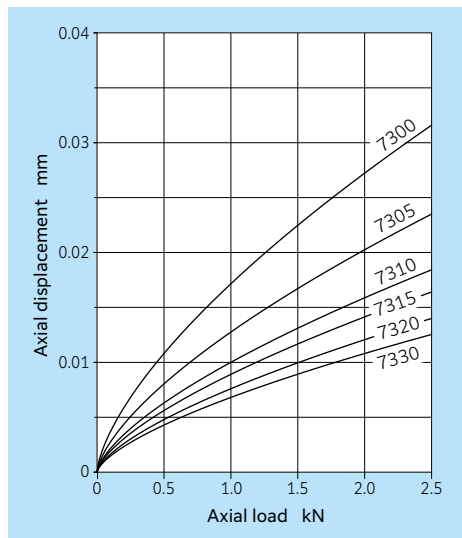

Fig. 17.2.5 Series 73 axial load vs. axial displacement

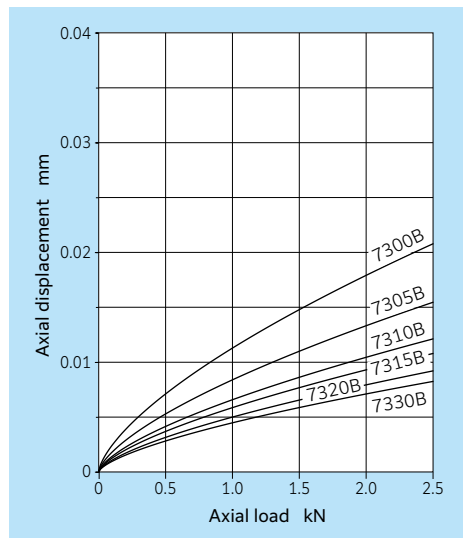

Fig. 17.2.6 Series 73B axial load vs. axial displacement

Note: Please consult **NTN** Engineering for other types and sizes.

*This technical data shows calculated values based on representative values, **NTN** does not guarantee these values.

17.2.2 Tapered roller bearings

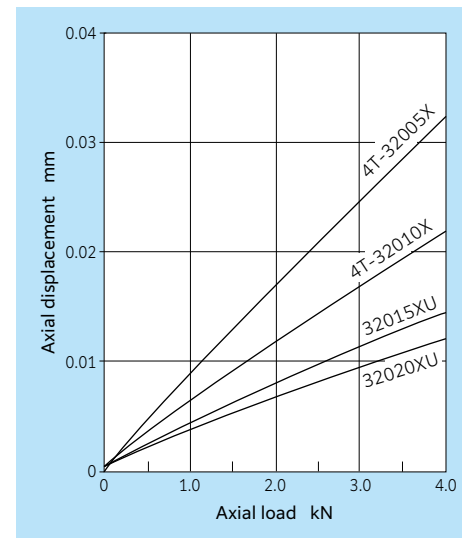

Fig. 17.2.7 Series 320 axial load vs. axial displacement

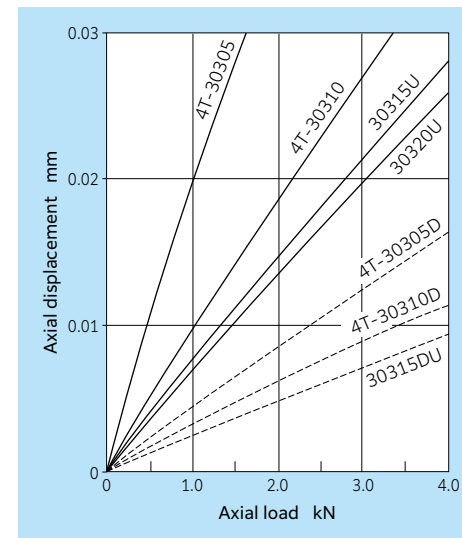

Fig. 17.2.9 Series 303/303 D axial load vs. axial displacement

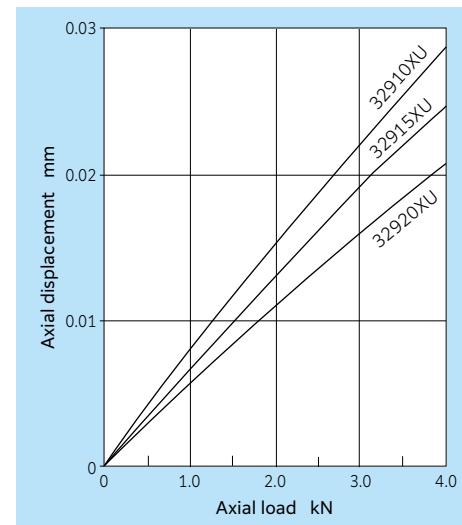

Fig. 17.2.8 Series 329 axial load vs. axial displacement

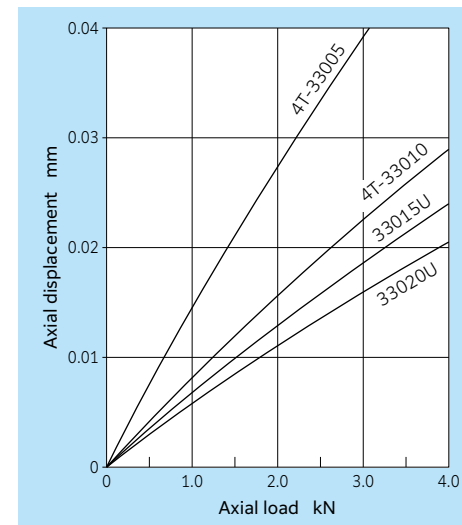

Fig. 17.2.10 Series 330 axial load vs. axial displacement

Note: 1. Values when the shaft and the housing are rigid bodies.
 2. Axial displacement may increase depending on the shape of the shaft/housing and fitting conditions.
 3. Please consult **NTN** Engineering for other types and sizes.

*This technical data shows calculated values based on representative values, **NTN** does not guarantee these values.

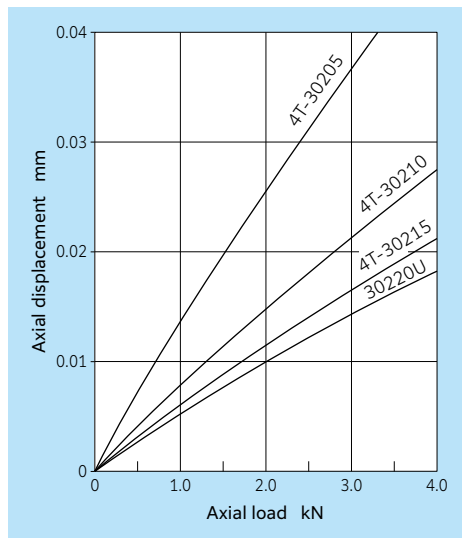

Fig. 17.2.11 Series 302 axial load vs. axial displacement

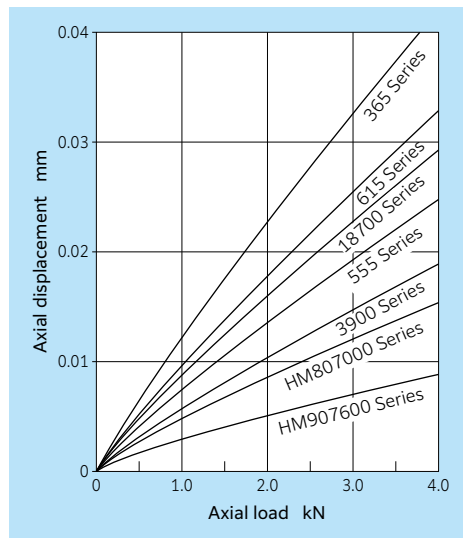

Fig. 17.2.12 Inch series axial load vs. axial displacement

- Note:
1. Values when the shaft and the housing are rigid bodies.
 2. Axial displacement may increase depending on the shape of the shaft/housing and fitting conditions.
 3. Please consult **NTN** Engineering for other types and sizes.

*This technical data shows calculated values based on representative values, **NTN** does not guarantee these values.

17.3 Allowable axial load

17.3.1 Deep groove ball bearings

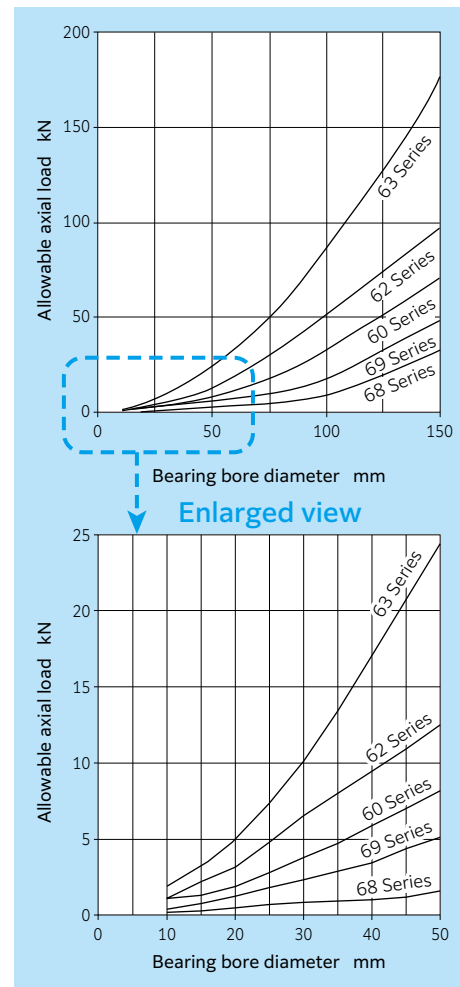

Fig. 17.3.1 Allowable axial load for deep groove ball bearings

- Note:
1. Calculation of the allowable axial load uses the median of the radial clearance CN.
 2. When an axial load is applied, the allowable axial load is the load whereby the contact ellipse exceeds the shoulder of the raceway.
 3. Please consult **NTN** Engineering for other types and sizes.

17.3.2 Angular contact ball bearings

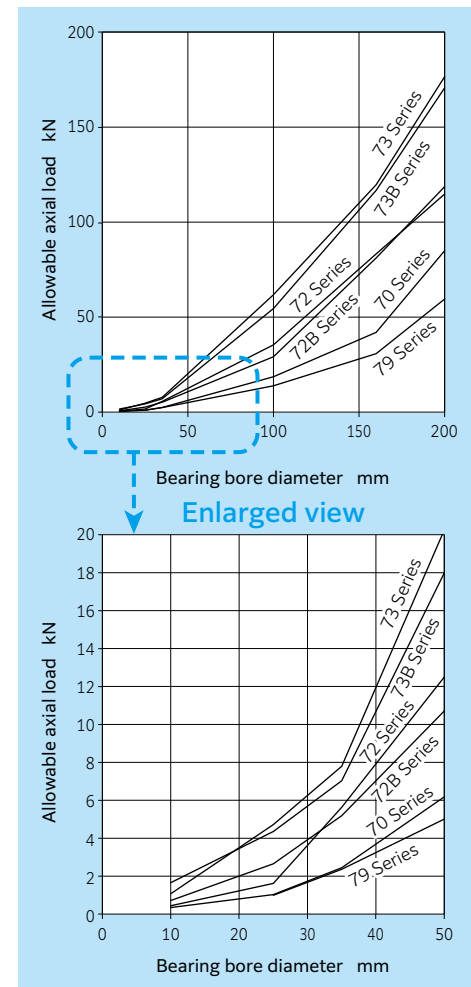

Fig. 17.3.2 Allowable axial load for angular contact ball bearings

- Note:
1. When an axial load is applied, the allowable axial load is the load whereby the contact ellipse exceeds the shoulder of the raceway.
 2. Please consult **NTN** Engineering for other types and sizes.

17.4 Fitting surface pressure

Table 17.4.1 lists equations for calculating the pressure and maximum stress between fitting surfaces.

Table 17.4.2 can be used to determine the approximate average groove diameter for bearing inner and outer rings.

The effective interference, in other words the actual interference Δ_{deff} after fitting, is smaller than the apparent interference Δd derived from the measured values for the bearing bore diameter and shaft. This difference is due to

the roughness or variations of the finished surfaces to be fitted. Due to this, it is necessary to assume the following reductions in effective interference:

For ground shafts: 1.0 to 2.5 μm

For lathed shafts: 5.0 to 7.0 μm

Figure 17.4.1 and Figure 17.4.2 show the root approximate values of the fitting surface pressure and the maximum stress when the solid steel shaft and the inner ring of 0 class bearings ($d/D_i = 0.8$) are fit.

Table 17.4.1 Fitting surface pressure and maximum stress



Fit condition		Calculation formula	Symbol (Unit: N, mm)
Fitting surface pressure MPa	Two cylinders General type	$P = \frac{E_1 E_2}{E_2 \left\{ \frac{d_1^2 + d_2^2}{d_1^2 - d_2^2} + \nu_1 \right\} + E_1 \left\{ \frac{d_2^2 + d_3^2}{d_2^2 - d_3^2} - \nu_2 \right\}} \cdot \frac{\Delta d_e}{d_2}$	P : Fitting surface pressure E_1, E_2 : Young's modulus of outer and inner cylinders ν_1, ν_2 : Poisson's ratio of outer and inner cylinders Δd_e : Effective interference of two cylinders 
	Solid steel shaft/ inner ring fit	$P = \frac{E}{2} \frac{\Delta_{deff}}{d} \left[1 - \left(\frac{d}{D_i} \right)^2 \right]$	d : Shaft diameter, inner ring bore diameter d_o : Hollow shaft inner diameter D_i : Inner ring average groove diameter Δ_{deff} : Effective interference E : Longitudinal elasticity factor = 208,000 MPa 
	Hollow steel shaft/ inner ring fit	$P = \frac{E}{2} \frac{\Delta_{deff}}{d} \frac{[1 - (d/D_i)^2] [1 - (d_o/d)^2]}{[1 - (d_o/D_i)^2]}$	d : Shaft diameter, inner ring bore diameter d_o : Hollow shaft inner diameter D_i : Inner ring average groove diameter Δ_{deff} : Effective interference E : Longitudinal elasticity factor = 208,000 MPa 
	Steel housing/ outer ring fit	$P = \frac{E}{2} \frac{\Delta_{Deff}}{D} \frac{[1 - (D_o/D)^2] [1 - (D/D_h)^2]}{[1 - (D_o/D_h)^2]}$	D : Housing inner diameter, bearing outer diameter D_o : Outer ring average groove diameter D_h : Housing outer diameter Δ_{Deff} : Effective interference 
Maximum stress MPa	Shaft/ inner ring fit	$\sigma_{t \max} = P \frac{1 + (d/D_i)^2}{1 - (d/D_i)^2}$	Inner ring bore diameter maximum circumferential stress.
	Housing/ outer ring fit	$\sigma_{t \max} = P \frac{2}{1 - (D_o/D)^2}$	Outer ring outer diameter maximum circumferential stress.

Table 17.4.2 Average groove diameter (approximate expression)

Bearing type		Average groove diameter	
		Inner ring	Outer ring
Deep groove ball bearings	All types	$1.05 \frac{4d + D}{5}$	$0.95 \frac{d + 4D}{5}$
	12	$1.03 \frac{3d + D}{4}$	$0.97 \frac{d + 2D}{3}$
Self-aligning ball bearings	13, 22	$1.03 \frac{3d + D}{4}$	$0.97 \frac{d + 3D}{4}$
	23	$1.03 \frac{4d + D}{5}$	$0.97 \frac{d + 4D}{5}$
Cylindrical roller bearing ¹⁾	All types	$1.05 \frac{3d + D}{5}$	$0.98 \frac{d + 3D}{4}$
Spherical roller bearings	Type B, type C, type 213	$\frac{2d + D}{3}$	$0.97 \frac{d + 4D}{5}$
	ULTAGE	$\frac{3d + D}{4}$	$0.98 \frac{d + 5D}{6}$
Tapered roller bearings	All types	$\frac{3d + D}{4}$	$\frac{d + 3D}{4}$

Note: d : inner ring bore diameter (mm) D : outer ring outer diameter (mm)

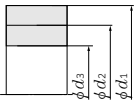
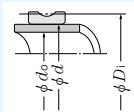
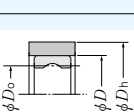
1) Average groove diameter values shown for double-flange type.

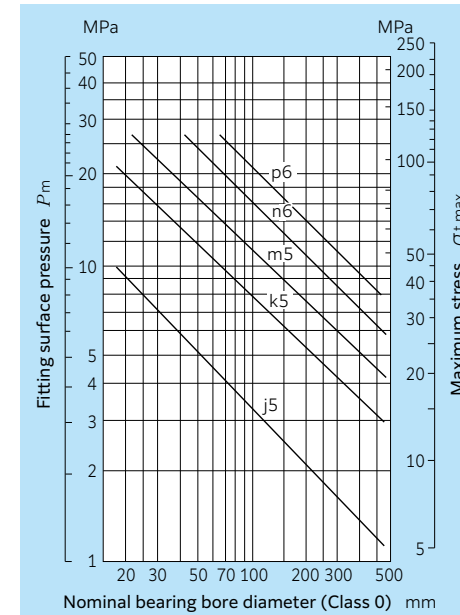

Fig. 17.4.1 Average fit interference as it relates to surface pressure P_m and maximum stress $\sigma_{t \max}$

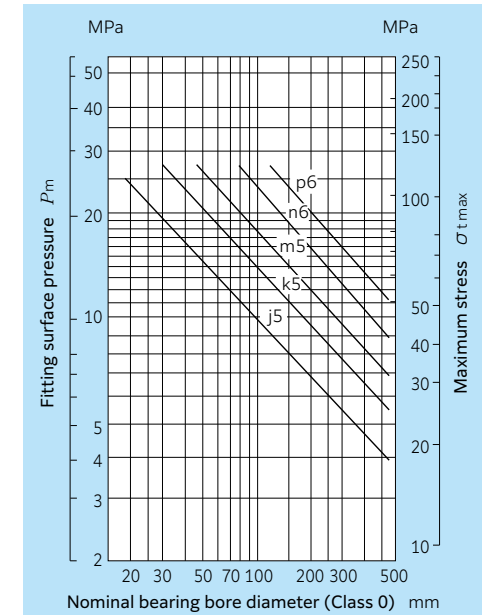

Fig. 17.4.2 Maximum fit interference as it relates to surface pressure P_m and maximum stress $\sigma_{t \max}$

Note: For the recommended fitting, see the section of "7.3.2 Recommended fitting."

17.5 Necessary press fit and pullout force

Equations (17.1) and (17.2) below can be used to calculate the necessary pullout force for press fits on inner rings and shafts or outer rings and housings. The force obtained by the equations only serves as an approximation, and a larger load may be required for the actual installation and removal.

For shaft and inner rings:

$$K_d = \mu \cdot P \cdot \pi \cdot d \cdot B \dots\dots\dots (17.1)$$

For housing and outer rings:

$$K_D = \mu \cdot P \cdot \pi \cdot D \cdot B \dots\dots\dots (17.2)$$

Where:

- K_d : Inner ring press fit or pullout force N
- K_D : Outer ring press fit or pullout force N
- P : Fitting surface pressure MPa
(see **Table 17.4.1**)
- d : Shaft diameter, inner ring bore diameter mm
- D : Housing inner diameter, outer ring outer diameter mm
- B : Inner or outer ring width mm
- μ : Sliding friction coefficient
(see **Table 17.5.1**)

Table 17.5.1 Press fit and pullout sliding friction coefficient

Concern	μ
Inner (outer) ring press fit onto cylindrical shaft (bore)	0.12
Inner (outer) ring pullout from cylindrical shaft (bore)	0.18
Inner ring press fit onto tapered shaft or sleeve	0.17
Inner ring pullout from tapered shaft	0.14
Sleeve press fit onto shaft/bearing	0.30
Sleeve pullout from shaft/bearing	0.33

17.6 Bearing technique calculation tool

The following calculations can be performed by using the bearing technique calculation tool on the **NTN** website (<https://www.ntnglobal.com>).

- Basic rating life calculation of single bearing
- Basic rating life calculation of gear load and bearing
- Basic rating life calculation of bearing load and bearing
- Calculation of operating clearance
- Calculation of bearing vibration frequency

Ball and Roller Bearings



INDEX OF BEARING TABLES

NTN New Generation Bearings (ULTAGE series) B- 5

Deep Groove Ball Bearings B-17

Deep Groove Ball Bearings 67, 68, 69, 160, 60, 62, 63, 64 B-22

Expansion Compensating Bearings EC-60, EC-62, EC-63 B-40

AC Bearings AC-60, AC-62, AC-63 B-42

Miniature and Small Size Ball Bearings B-45

Metric series 67, 68, 69, 60, 62, 63, BC B-48

Inch series R, RA B-52

With snap ring groove and snap ring SC B-54

Angular Contact Ball Bearings B-57

Single and Duplex Angular Contact Ball Bearings 79, 70, 72, 72B, 73, 73B B-60

Four-Point Contact Ball Bearings QJ2, QJ3 B-72

Double Row Angular Contact Ball Bearings 52, 53 B-74

Self-Aligning Ball Bearings B-79

12(K), 22(K), 13(K), 23(K) B-82

Adapters (For self-aligning ball bearings) B-88

Cylindrical Roller Bearings B-93

NU, NJ, NUP, N, NF10, 2, 22, 3, 23, 4 B-98

L type collar ring HJ2, 22, 3, 23, 4 B-116

Double Row Cylindrical Roller Bearings NN49(K), NNU49(K), NN30(K), NNU30(K) B-120

Tapered Roller Bearings B-127

Metric series 329X, 320X, 330, 331, 302, 322, 322C, 332, 303, 303D, 313X, 323, 323C B-134

Inch series B-154

Double Row Tapered Roller Bearings (Back-to-back arrangement) 4130, 4230, 4131, 4231, 4302, 4322, 4303, 4303D, 4323 B-192

Double Row Tapered Roller Bearings (Face-to-face arrangement) 3230, 3231 B-206

Spherical Roller Bearings B-211

239(K), 230(K), 240(K30), 231(K), 241(K30), 222(K), 232(K), 213(K), 223(K) B-218

Adapters (For spherical roller bearings) B-240

Withdrawal Sleeves (For spherical roller bearings) B-245

Thrust Bearings B-253

Thrust Ball Bearings 511, 512, 513, 514 B-256

Thrust Spherical Roller Bearings 292, 293, 294 B-260

NTN New Generation Bearings (ULTAGE Series)



Introduction of ULTAGE series

“ULTAGE” (a name created from the combination of “ultimate,” signifying refinement, and “stage,” signifying **NTN**'s intention that this series of products be employed in diverse applications) is the general name for **NTN**'s new generation of rolling bearings that are noted for their industry-leading performance. **NTN** is developing and expanding the ULTAGE series of each bearing type. Please see the introductory article on the following pages. The corresponding dimensions are specified in the dimension tables of each bearing type.

For details, see the following **NTN** catalogs.

- ULTAGE series cylindrical roller bearings CAT.No.3037/E
- ULTAGE metric series large size tapered roller bearings CAT.No.3035/E
- ULTAGE series spherical roller bearings [Type EA, Type EM] CAT.No.3033/E

The following ULTAGE series bearings for special applications are also available.
For further details, please refer to the section of “C. Special application bearings.”

- ULTAGE series sealed four-row tapered roller bearings for rolling mill roll necks [CROU...LL type]
- ULTAGE series sealed spherical roller bearings [WA type]
- ULTAGE series spherical roller bearings with high-strength cage [EMA type]
- ULTAGE series deep groove ball bearings for high-speed servo motors [MA type]
- ULTAGE series precision rolling bearings for machine tools

Cylindrical roller bearings [ULTAGE series]

ULTAGE series cylindrical roller bearings are the standard series developed to meet the demands of "long operating life," "improved load capability," and "higher speed" that are required for various industrial machinery.

High reliability

- Higher load capacity through optimization of internal specifications
- Extension of maintenance period

Improved load capacity

- Allowable misalignment: 1/500 (mm/mm)
- * Under the condition of $F_r \leq 0.20 C_r$

Higher speed

- The allowable speed is improved by up to 20% through optimization of internal specifications
- * During oil lubrication

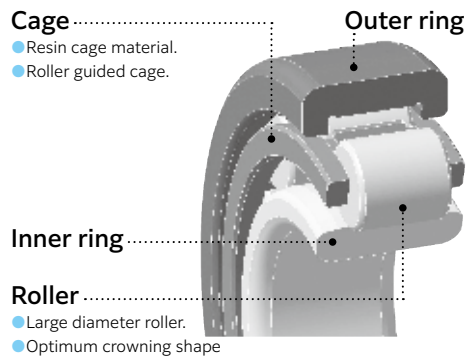

- Cage**.....
- Resin cage material.
 - Roller guided cage.

Inner ring.....

- Roller**.....
- Large diameter roller.
 - Optimum crowning shape

Features

1. Industry leading load rating

Higher load capacity and longer operating life have been realized through the optimization of internal specifications.

- (1) **Rating life: Up to 1.8 times longer** (compared with NTN E type product)
- (2) **Basic dynamic load rating: Up to 20% higher** (compared with NTN E type product)

2. Allowable misalignment (refer to Fig. 1)

Allowable misalignment: 1/500 (mm/mm)
 Optimization of the roller crowning allows a combination of heavy loads (0.20 C_r) and allowable misalignment of 1/500 (mm/mm).
 * Necessary minimum load: 0.04 C_0r

3. Allowable speed

The allowable speed is increased up to 20% in oil lubrication (compared with NTN E type product).

4. Standard resin cage (refer to Fig. 2)

- (1) Higher speed and longer operating life have been realized through the use of a window type combined PA resin cage.
 - (2) Resin cage materials: reinforced PA + GF
- * When machined cages are necessary for high speed and other special applications, consult NTN Engineering.

5. Interchangeability

The boundary dimensions conform to ISO 15, JIS B 1533, and DIN 5412 and are the same as that of the NTN E type products.

6. Allowable axial load

Same as NTN E type product

7. Allowable temperature

Allowable bearing operating temperature:
 120°C (instantaneous) 100°C (continuous)

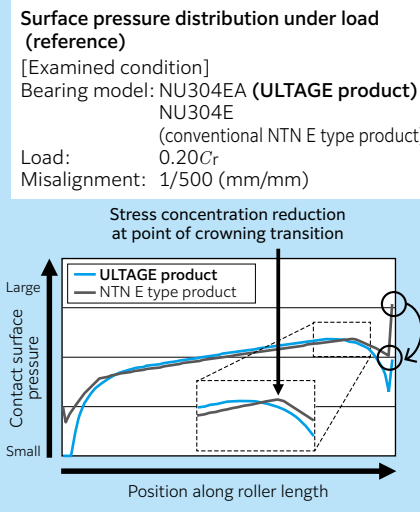

Fig. 1

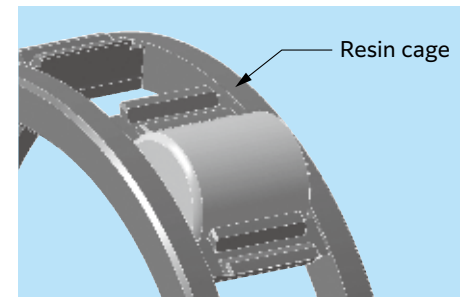
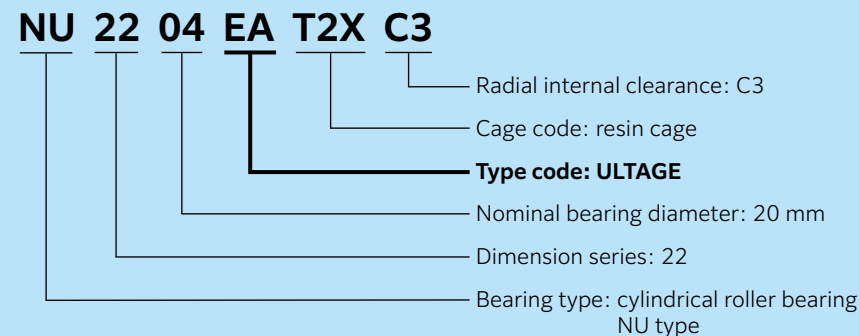

Fig. 2

Bearing number

Cylindrical roller bearing



* When the bearing is the NUP type, a code U is added at the end of the part number.

Large size tapered roller bearings [ULTAGE metric series]

Large size tapered roller bearings (ULTAGE metric series with an outer diameter of $\phi 270$ mm or more) are the standard series developed to meet the demands of "long operating life," "improved load capability," and "higher speed" that are required for various industrial machinery.

[Bearing type]

NU type structure

- Outer ring (with double flange)
- Roller
- Cage
- Inner ring (with no flanges)

The outer ring, roller, cage assembly, and inner ring can be separated.

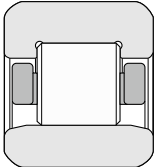

NJ type structure

- Outer ring (with double flange)
- Roller
- Cage
- Inner ring (with single flange)

The outer ring, roller, cage assembly, and inner ring can be separated.

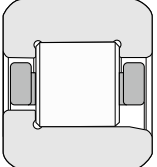

NUP type structure

- Outer ring (with double flange)
- Roller
- Cage
- Inner ring (with single flange)
- Inner ring collar ring

The outer ring, roller, cage assembly, inner ring, and collar ring can be separated.

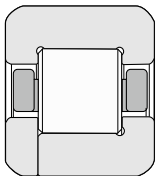
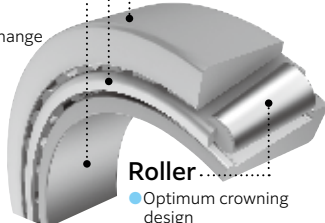
- Cage**
 - Roller guided cage.
- Outer ring**
 - Temperature stabilized bearing steel.
 - Dimensional change over time is reduced.
- Inner ring**
 - Temperature stabilized bearing steel.
 - Dimensional change over time is reduced.
 - Optimum flange design
- Roller**
 - Optimum crowning design

High reliability

- Higher load capacity through optimum design of internal specifications
- Longer maintenance intervals

Improved load capacity

- Allowable misalignment 1/600
- *Under the condition of $F_r \leq 0.27 C_r$

Higher speed

- The allowable speed is improved by up to 10% through optimization of the sliding contact zone between the roller and the inner ring

Features

1. Industry leading reliability

The bearing load carrying capability has been improved by optimizing the roller crowning to reduce edge stress and allow a more uniform pressure distribution across the contact surface (see Fig. 1).

- (1) **Rating life: 3 times longer (compared to conventional NTN products)**
- (2) **Basic dynamic rating load: 30% larger (compared to conventional NTN products)**

2. Allowable misalignment

Allowable misalignment (single row): 1/600

Optimization of the roller crowning has allowed a combination of heavy loads ($0.27 C_r$) and allowable misalignment of 1/600.

*Necessary minimum load: $0.04 C_{0r}$

Fig. 1 shows the contact surface pressure distribution of rollers considering an applied radial load of $F_r \leq 0.27 C_r$. By optimizing the roller crowning, the edge stress is greatly reduced and the contact surface pressure is made uniform compared with conventional products.

[Examined condition]

Bearing model : ULTAGE product and conventional NTN product ($\phi 80 \times \phi 170 \times 42.5$)

Load : $0.27 C_r$

Allowable misalignment: 1/600

*The allowable misalignment differs depending on the loads and the bearing type. Please consult NTN Engineering.

3. Allowable speed

The allowable speed is improved by up to 10% (compared with the conventional NTN products) by optimizing the sliding contact zone between the roller and the inner ring, thus reducing the rotational torque and temperature rise (see Fig. 2, Fig. 3, and Fig. 4).

4. Dimensional change over time

Dimensional change of bearings over time has been reduced compared with conventional products by applying special heat treatment to bearing steel.

- Reduction in dimension change over time
- Conventional heat treatment: 1/10
- Case hardened steel ratio : 1/4

5. Interchangeability

The boundary dimensions conform to JIS B 1512-3 and ISO 355, and the installation dimensions are the same as that of the conventional NTN products.

In addition, the precision also conforms to JIS B 1514-1 and ISO 492.

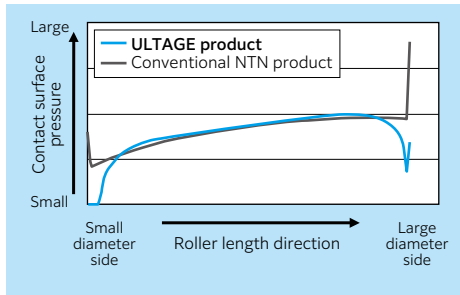

Fig. 1 Contact surface pressure distribution of rollers

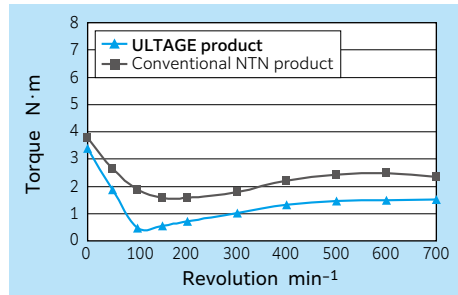

Fig. 3 Torque test result

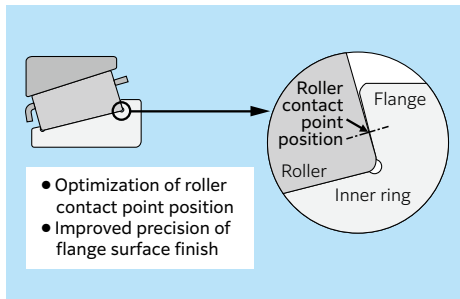

Fig. 2 Optimization of sliding surface between roller and inner ring

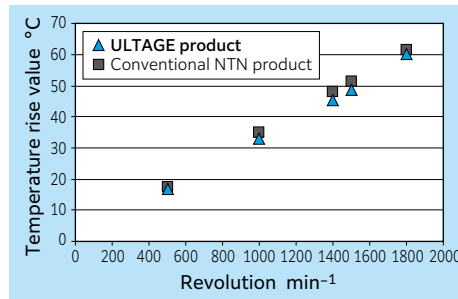

Fig. 4 Temperature rise test result

Bearing number

Single row tapered roller bearing

3 03 28 U UTG

- Type code: **ULTAGE**
- Internationally interchangeable bearings
- Nominal bore diameter: 140 mm
- Dimension series: 03
- Bearing type: single row tapered roller bearing

Double row back-to-back tapered roller bearing

43 03 28X UTG

- Type code: **ULTAGE**
- Nominal bore diameter: 140 mm
- Dimension series: 03
- Bearing type: double row back-to-back tapered roller bearing

Double row face-to-face tapered roller bearing

32 31 32 UTG

- Type code: **ULTAGE**
- Nominal bore diameter: 160 mm
- Dimension series: 31
- Bearing type: double row face-to-face tapered roller bearing

Spherical roller bearings [ULTAGE series EA/EM types]

ULTAGE series spherical roller bearings are the standard series developed to meet the demands of "long operating life," "higher speed," and "improved easy handling" that are required for various industrial machinery.

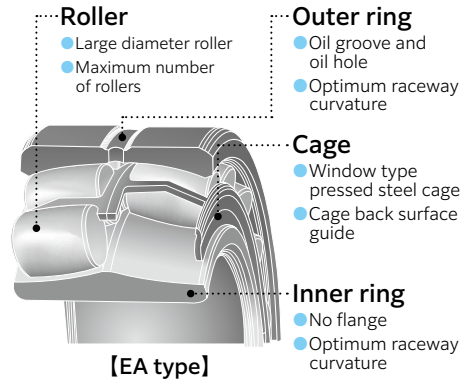
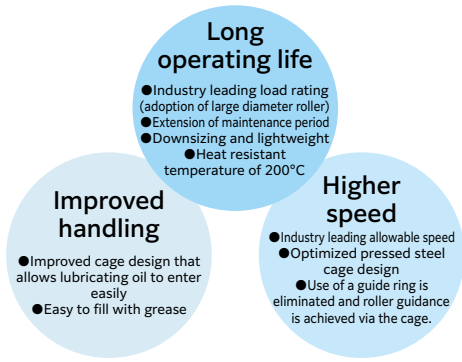

Features [EA type]

1. Industry leading load rating

Higher load capacity and longer operating life are realized by increasing the roller diameter and maximizing the number of rollers. This allows extension of the maintenance period (see Fig. 1).

- (1) Basic dynamic rating load: Up to 65% higher (compared to conventional products)
- (2) Basic static rating load: Up to 35% higher (compared to conventional products)
- (3) Rating life: Up to 5 times longer (compared to conventional products)

2. Allowable speed of the world's highest level

Higher speed is realized through the adoption of a new pressed steel cage design. [Allowable speed: 20% higher (compared to conventional products)]

3. Standard use of pressed steel cage

For the pressed steel cage, "window type" with rigidity is adopted, and the roller pocket is provided with four tabs (projections) (see Fig. 2 and Fig. 3).

- (1) Cage back surface used for guidance.
- (2) The four pocket tabs stabilize the position of rollers.
- (3) The new pocket shape allows consistent supply of lubricating oil and grease to the internal bearing surfaces (see Fig. 4).
- (4) Special surface treatment is applied to the entire surface to improve the abrasion resistance.

4. Downsizing and lightweight

High-load capacity has allowed for downsizing and a lighter weight.

Comparison example

Bearing number	Rating load (kN)		Boundary dimension (mm)	Bearing volume (cm ³)	Mass (kg)
	C _r	C _{0r}			
22220B	315	415	φ100×φ180×46	810	4.95
22218EA	385	398	φ90×φ160×40	550	3.28

The volume weight and mass weight can be reduced by about 30%.

5. Improved handling

Adoption of the simple window type new pressed steel cage improved the workability at the time of assembly, disassembly, and grease application.

- (1) Easy to fill with grease to roller surface
- (2) Easy assembly and disassembly due to small roller drop

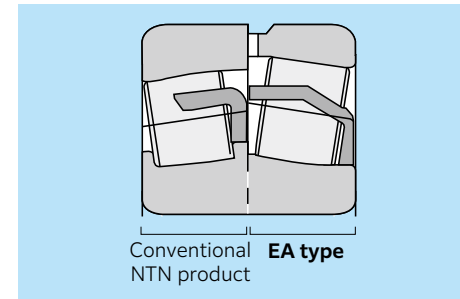

Fig. 1

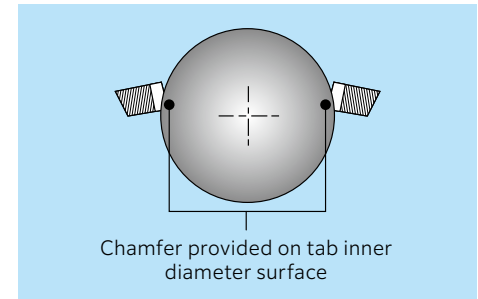

Fig. 3

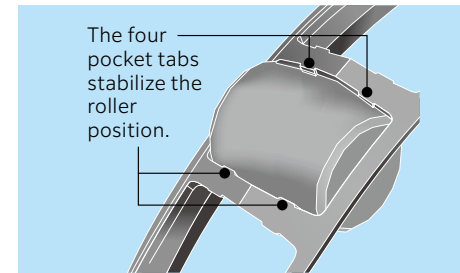

Fig. 2

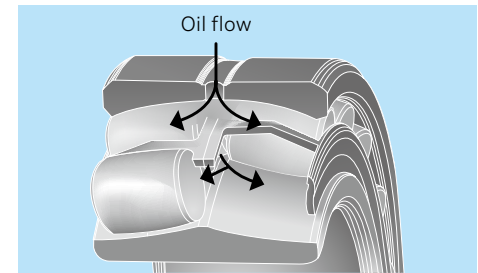
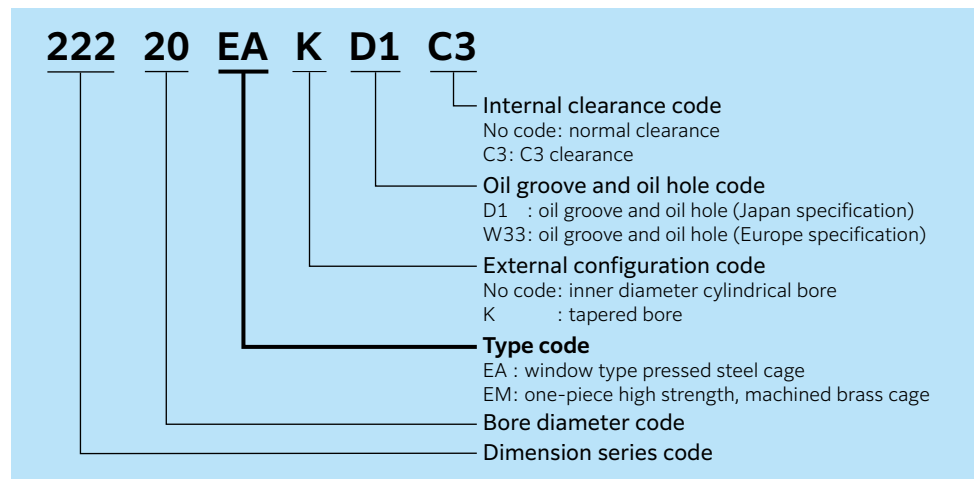

Fig. 4

Bearing number

Spherical roller bearing



A combined machined cage (EM type) is recommended for conditions with severe vibration and impact. (EM type and EA type have different inner ring shapes.)

EA type

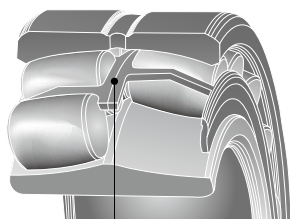

Window type pressed steel cage

EM type

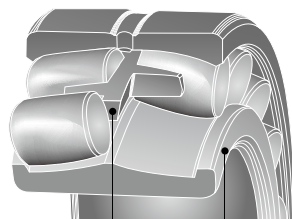

One-piece machined cage Inner ring flange

EM type (large size)

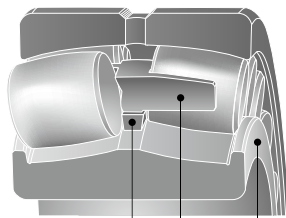

Guide ring One-piece machined cage Inner ring flange

[Allowable misalignment]

- Normal load or more 1/115
- Light load 1/30

*Misalignment beyond the above limits may cause the roller to protrude from the outer ring, causing interference with the peripheral components.

Deep Groove Ball Bearings

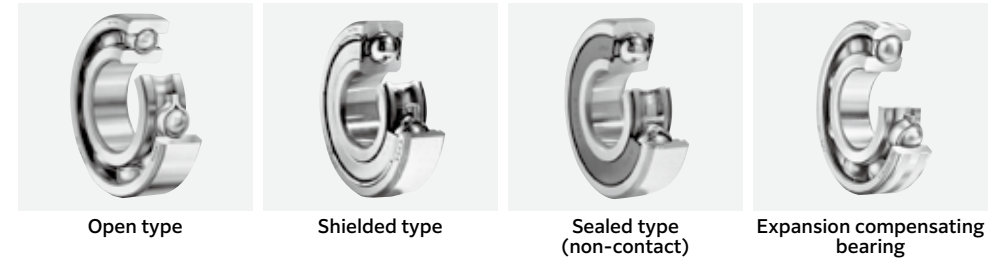

1. Design features and characteristics

Deep groove ball bearings are very widely used. A deep groove is formed on the inner and outer ring of the bearing enabling the bearing to sustain radial and axial loads in either direction as well as the complex loads which result from the combination of these forces. Deep groove ball bearings are suitable for high speed applications.

When two or more deep groove ball bearings are used in combination and mounted adjacent to each other a duplex set (D2) should be used. Duplex bearings (D2) utilize controlled tolerances

to more evenly distribute the loading between the individual bearing rows which improves the overall performance of the assembly.

In addition to unsealed and unlubricated “open” bearings, NTN provides deep groove ball bearings that are pre-lubricated with grease and enclosed by seals or shields. See section “11. Lubrication” for a list of some of the greases which can be used.

Table 1 shows the construction and special characteristics of various sealed deep groove ball bearings.

Table 1 Sealed ball bearings: construction and characteristics

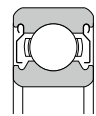
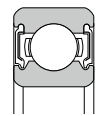
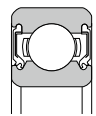
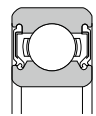
Types and codes	Shielded type		Sealed type		
	Non-contact type ZZ	Non-contact type LLB	Contact type LLU	Low torque type LLH	
Construction					
	• Metal shield plate is affixed to the outside ring; the inner ring incorporates a V-groove and labyrinth clearance.	• The outer ring incorporates synthetic rubber molded to a steel plate; seal edge is aligned with V-groove along inner ring surface with labyrinth clearance.	• The outer ring incorporates synthetic rubber molded to a steel plate; seal edge contacts V-groove along inner ring surface.	• Basic construction is the same as LLU type, but a specially designed lip on the edge of the seal prevents foreign matter penetration; low torque construction.	
Performance comparison	Torque	Small	Small	Higher	Medium
	Dust proofing	Good	Better than ZZ-type	Excellent	Much better than LLB-type
	Water proofing	Poor	Poor	Very good	Good
	High speed capacity	Same as open type	Same as open type	Limited by contact seals	Much better than LLU-type
	Allowable temp. range ¹⁾	Depends on lubricant	-25 to 120°C	-25 to 110°C	-25 to 120°C

1) Please consult NTN Engineering about applications which exceed the allowable temperature range of products listed on this table. Note: This chart lists double shielded and double sealed bearings, but single shielded (Z) and single sealed (LB, LU, LH) are also available. Grease lubrication should be used with single shielded and single sealed bearings.

2. Standard cage type

As shown in Table 2, pressed steel cages are generally used for most deep groove ball bearings. Larger size deep groove ball bearings, and bearings operating at high rotational speeds often utilize a machined metallic cage.

Table 2 Standard cage for deep groove ball bearings

Cage type	Pressed cages	Machined cages
Bearing series		
67	6700~ 6706	—
68	6800~ 6834	6836~ 68/600
69	6900~ 6934	6936~ 69/500
160	16001~16052	16056~16072
60	6000~ 6052	6056~ 6084
62	6200~ 6244	—
63	6300~ 6344	—
64	6403~ 6416	—

3. Other deep groove ball bearing enhancements

3.1 Bearings with snap rings

A snap ring groove or snap ring groove with snap ring combination are optional enhancements for the outer diameter of most deep groove ball bearings. Snap rings allow for simpler axial positioning and installation in the housing. Snap rings can be utilized with both open type and sealed or shielded deep groove ball bearings. Consult NTN Engineering.

3.2 Expansion compensating bearings (creep prevention bearings)

NTN offers the innovative Expansion Compensating (EC) feature to help with bearing retention when mounted in light alloy housings which is often a problem at elevated temperatures due to property differences between the bearing steel and the housing. This functionality is achieved by machining circumferential grooves into the outer diameter of an otherwise standard outer ring. These grooves are filled with an optimized polymer which has an expansion rate higher than that of the typical light alloy housing. The net result is a more consistent interference fit across a wide operating temperature range. This more consistent fit condition helps prevent the bearing from rotating within the housing (known as bearing creep) which helps ensure good performance and long life.

(1) Allowable load

As a result of having grooves machined in the outer diameter, the ring strength is lower compared with a standard bearing. Thus, in order to prevent outer ring fracture, it is necessary to limit the maximum load applied to the bearing to be equal to or less than the allowable load C_p (see dimension table).

(2) Fit with housing

Table 3 shows the recommended fits for bearings with light metal alloy housings. In cases where the bearing is going to be interference fit with the housing, it is very important not to damage the polymer material. Therefore, it is essential that the lip of the housing diameter be given a 10-15° chamfer as shown in Fig. 2. Furthermore, as shown in Fig. 2, it is also advisable to apply the interference fit using a press in order not to force the bearing into the housing in a misaligned position.

Table 3 Recommended fits for outer ring and housing bore

Condition		Suitable bearing	Housing bore tolerance class
Load type, etc.	Housing material		
Rotating outer ring load Rotating inner ring load Indeterminate load	Light load Normal load	Deep groove ball bearings Cylindrical roller bearings	H6
Rotating outer ring load Indeterminate load	Heavy load Impact load	Light alloys such as Al alloy and Mg alloy Thick-walled type deep groove ball bearings	N6

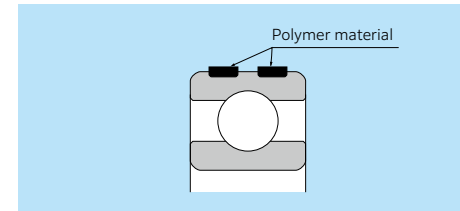

Fig. 1. Expansion compensating bearings

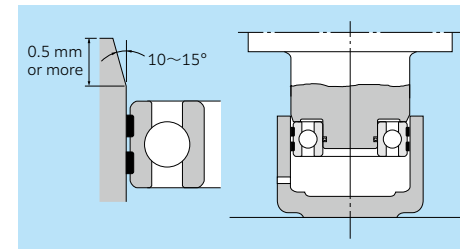

Fig. 2. Fitting method and housing inner diameter chamfer

(3) Radial internal clearance

Radial internal clearance are the same as those for standard deep groove ball bearings. With standard fit and application conditions, a C3 clearance is used. For more detailed information concerning this bearing and the availability of roller bearings contact NTN Engineering.

(4) Allowable temperature range

-20 to 120°C

3.3 AC bearings (creep prevention bearings)

NTN Offers the AC type bearing which performs a similar function to the EC bearing. AC bearings have the same outer diameter dimensions as standard bearings with the addition of two O-rings located in circumferential grooves on the outside diameter of the outer ring. (Fig. 3) While the EC bearing is more beneficial when using a light alloy housing at elevated temperatures, AC bearings are suitable for applications where a "tight fit" is not possible but outer ring creeping exists under rotating load on the outer ring. AC bearing can also be installed as a floating side bearing to accommodate expansion of shaft by heat as it is more axial. Before installing the bearing into the housing, a high viscosity oil (base oil viscosity, 100 mm²/s or more) or grease must be applied to the space between two O-rings. This lubricant forms a thin oil layer on the bearing outer ring which prevents contact between the outer ring and housing, lowers the friction, and can minimize the occurrence of creeping by utilizing the friction force of the O-rings.

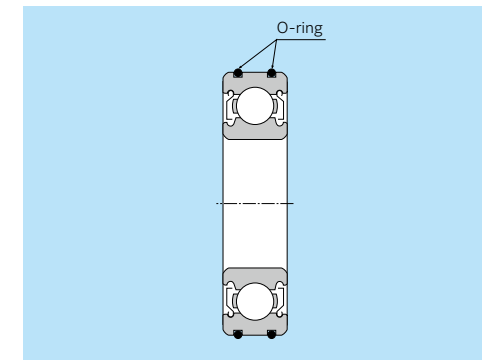

Fig. 3. AC bearing



(1) Allowable load

As is the case with the EC bearing, the load applied to an AC bearing shall be limited to C_p (see dimension table) in order to ensure the strength limit of the modified outer ring is not exceeded.

(2) Housing dimensions and shape

Fig. 4 shows the recommended shape of steel housings, and Table 4 shows the dimensions.

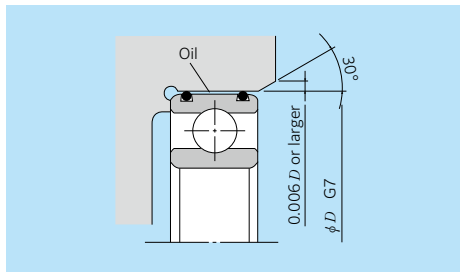

Fig. 4. Design of housing

Table 4 Dimensions and design

Housing bore tolerance	G7
Housing bore entrance chamfer	Max. 30°C
Housing bore chamfer undercut	0.006D or larger
Housing bore surface roughness R_a	2.5
Housing bore roundness	1/2 of bearing housing dimension tolerance

(3) Allowable temperature range

-25 to 120°C



Deep Groove Ball Bearings

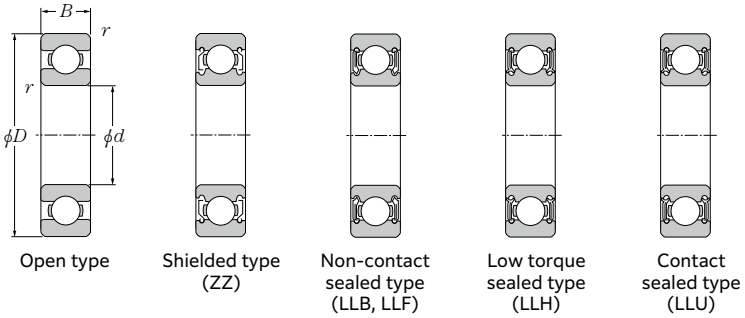

a 10 ~ 20mm

	Boundary dimensions				Basic load rating		Fatigue load limit C_u	Factor f_0	Allowable speed				Bearing number				
	mm				dynamic	static			Grease Open type, ZZ, LLB, LLF, Z, LB, LF	Oil Open type, Z, LB, LF	LLH	LLU	Open type	Shielded or sealed type ²⁾ (See drawings)			
	d	D	B	$r_{s\min}$ ¹⁾	C_r	C_{0r}									C_{10}	C_{20}	min^{-1}
10	15	3	0.1	—	0.950	0.435	0.018	15.7	10 000	12 000	—	—	6700	—	—	—	—
	19	5	0.3	—	2.03	0.925	0.072	14.8	32 000	38 000	—	—	6800	ZZ	LLB	—	LLU
	22	6	0.3	0.3	2.99	1.27	0.099	14.0	30 000	36 000	25 000	21 000	6900	ZZ	LLB	LLH	LLU
	26	8	0.3	—	5.05	1.96	0.138	12.4	29 000	34 000	25 000	21 000	6000	ZZ	LLB	LLH	LLU
	30	9	0.6	0.5	5.65	2.39	0.182	13.2	25 000	30 000	21 000	18 000	6200	ZZ	LLB	LLH	LLU
	35	11	0.6	0.5	9.10	3.50	0.273	11.4	23 000	27 000	20 000	16 000	6300	ZZ	LLB	LLH	LLU
12	18	4	0.2	—	1.03	0.530	0.021	16.2	8 300	9 500	—	—	6701	—	LLF	—	—
	21	5	0.3	—	2.12	1.04	0.080	15.3	29 000	35 000	—	20 000	6801	ZZ	LLB	—	LLU
	24	6	0.3	0.3	3.20	1.46	0.115	14.5	27 000	32 000	22 000	19 000	6901	ZZ	LLB	LLH	LLU
	28	7	0.3	—	5.65	2.39	0.187	13.2	26 000	30 000	—	—	16001JRX	—	—	—	—
	28	8	0.3	—	5.65	2.39	0.182	13.2	26 000	30 000	21 000	18 000	6001JRX	ZZ	LLB	LLH	LLU
	32	10	0.6	0.5	6.75	2.75	0.214	12.7	22 000	26 000	20 000	16 000	6201	ZZ	LLB	LLH	LLU
	37	12	1	0.5	10.8	4.20	0.325	11.1	20 000	24 000	19 000	15 000	6301	ZZ	LLB	LLH	LLU
15	21	4	0.2	—	1.04	0.585	0.024	16.5	6 600	7 600	—	—	6702	—	LLF	—	—
	24	5	0.3	—	2.30	1.26	0.091	15.8	26 000	31 000	—	17 000	6802	ZZ	LLB	—	LLU
	28	7	0.3	0.3	4.05	2.00	0.157	14.8	24 000	28 000	—	16 000	6902	ZZ	LLB	—	LLU
	32	8	0.3	—	6.20	2.84	0.222	13.9	22 000	26 000	—	—	16002	—	—	—	—
	32	9	0.3	0.3	6.20	2.84	0.199	13.9	22 000	26 000	18 000	15 000	6002	ZZ	LLB	LLH	LLU
	35	11	0.6	0.5	8.60	3.60	0.279	12.7	19 000	23 000	18 000	15 000	6202	ZZ	LLB	LLH	LLU
	42	13	1	0.5	12.7	5.45	0.425	12.3	17 000	21 000	15 000	12 000	6302	ZZ	LLB	LLH	LLU
17	23	4	0.2	—	1.11	0.660	0.027	16.3	5 000	6 700	—	—	6703	—	LLF	—	—
	26	5	0.3	—	2.47	1.46	0.102	16.1	24 000	28 000	—	15 000	6803	ZZ	LLB	—	LLU
	30	7	0.3	0.3	5.15	2.58	0.202	14.7	22 000	26 000	—	14 000	6903JRX	ZZ	LLB	—	LLU
	35	8	0.3	—	7.55	3.35	0.263	13.6	20 000	24 000	—	—	16003	—	—	—	—
	35	10	0.3	0.3	7.55	3.35	0.243	13.6	20 000	24 000	16 000	14 000	6003	ZZ	LLB	LLH	LLU
	40	12	0.6	0.5	10.6	4.60	0.355	12.8	18 000	21 000	15 000	12 000	6203	ZZ	LLB	LLH	LLU
	47	14	1	0.5	15.0	6.55	0.510	12.2	16 000	19 000	14 000	11 000	6303	ZZ	LLB	LLH	LLU
	62	17	1.1	—	25.2	10.8	0.840	11.1	14 000	16 000	—	—	6403	ZZ	—	—	—
20	27	4	0.2	—	1.15	0.730	0.031	16.1	5 000	5 700	—	—	6704	—	LLF	—	—
	32	7	0.3	0.3	4.45	2.47	0.185	15.5	21 000	25 000	—	13 000	6804JR	ZZ	LLB	—	LLU
	37	9	0.3	0.3	7.05	3.70	0.288	14.7	19 000	23 000	—	12 000	6904	ZZ	LLB	—	LLU
	42	8	0.3	—	8.75	4.50	0.350	14.5	18 000	21 000	—	—	16004	—	—	—	—
	42	12	0.6	0.5	10.4	5.05	0.355	13.9	18 000	21 000	13 000	11 000	6004	ZZ	LLB	LLH	LLU
	47	14	1	0.5	14.2	6.65	0.505	13.2	16 000	18 000	12 000	10 000	6204	ZZ	LLB	LLH	LLU
	52	15	1.1	0.5	17.6	7.90	0.615	12.4	14 000	17 000	12 000	10 000	6304	ZZ	LLB	LLH	LLU

1) Smallest allowable dimension for chamfer dimension r . 2) This bearing number is for double sealed and double shielded type bearings, but single sealed and single shielded type are also available. B-22

Deep Groove Ball Bearings

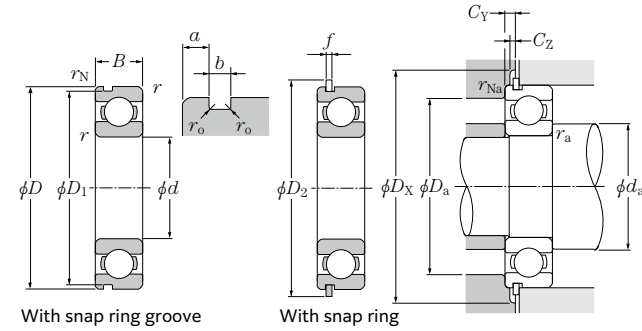

Dynamic equivalent radial load
 $P_r = XF_r + YF_a$

$\frac{f_0 \cdot F_a}{C_{0r}}$	e	$\frac{F_a}{F_r} \leq e$		$\frac{F_a}{F_r} > e$	
		X	Y	X	Y
		0.172	0.19		
0.345	0.22				1.99
0.689	0.26				1.71
1.03	0.28				1.55
1.38	0.30	1	0	0.56	1.45
2.07	0.34				1.31
3.45	0.38				1.15
5.17	0.42				1.04
6.89	0.44				1.00

Static equivalent radial load
 $P_{0r} = 0.6F_r + 0.5F_a$
When $P_{0r} < F_r$ use $P_{0r} = F_r$.

Bearing number	Snap ring groove dimensions			Snap ring dimensions			Installation-related dimensions						Mass ⁵⁾			
	mm			mm			mm							kg		
	D_1	a	b	r_0	D_2	f	d_a	D_a	D_X	C_Y	C_Z	r_{as}			r_{Nas}	
—	—	—	—	—	—	—	10.8	—	14.2	—	—	—	—	0.1	—	0.0015
N	NR	20.8	1.05	0.8	0.2	24.8	0.7	12	13	20	25.5	1.5	0.7	0.3	0.3	0.009
— ⁶⁾	— ⁶⁾	—	—	—	—	—	—	12	13.5	24	—	—	—	0.3	—	0.019
N	NR	28.17	2.06	1.35	0.4	34.7	1.12	14	16	26	35.5	2.9	1.2	0.6	0.5	0.032
N	NR	33.17	2.06	1.35	0.4	39.7	1.12	14	17	31	40.5	2.9	1.2	0.6	0.5	0.053
—	—	—	—	—	—	—	—	13.6	13.8	16.4	—	—	—	—	—	0.002
—	—	—	—	—	—	—	—	14	14.5	19	—	—	—	—	—	0.006
N	NR	22.8	1.05	0.8	0.2	26.8	0.7	14	15	22	27.5	1.5	0.7	0.3	0.3	0.011
—	—	—	—	—	—	—	—	14	—	26	—	—	—	—	—	0.019
NX2	NX2RX3	26.44	2.20	0.90	0.3	32.7	0.85	14	16	26	33.4	2.8	0.9	0.3	0.3	0.021
N	NR	30.15	2.06	1.35	0.4	36.7	1.12	16	17	28	37.5	2.9	1.2	0.6	0.5	0.037
N	NR	34.77	2.06	1.35	0.4	41.3	1.12	17	18.5	32	42	2.9	1.2	1	0.5	0.06
—	—	—	—	—	—	—	—	16.6	16.8	19.4	—	—	—	—	—	0.0025
—	—	—	—	—	—	—	—	17	17.5	22	—	—	—	—	—	0.007
N	NR	26.7	1.3	0.95	0.25	30.8	0.85	17	17.5	26	31.5	1.9	0.9	0.3	0.3	0.016
—	—	—	—	—	—	—	—	17	—	30	—	—	—	—	—	0.025
N	NR	30.15	2.06	1.35	0.4	36.7	1.12	17	19	30	37.5	2.9	1.2	0.3	0.3	0.03
N	NR	33.17	2.06	1.35	0.4	39.7	1.12	19	20	31	40.5	2.9	1.2	0.6	0.5	0.045
N	NR	39.75	2.06	1.35	0.4	46.3	1.12	20	23	37	47	2.9	1.2	1	0.5	0.082
—	—	—	—	—	—	—	—	18.6	18.8	21.4	—	—	—	—	—	0.0025
—	—	—	—	—	—	—	—	19	19.5	24	—	—	—	—	—	0.008
N	NR	28.7	1.3	0.95	0.25	32.8	0.85	19	20	28	33.5	1.9	0.9	0.3	0.3	0.018
—	—	—	—	—	—	—	—	19	—	33	—	—	—	—	—	0.032
N	NR	33.17	2.06	1.35	0.4	39.7	1.12	19	21	33	40.5	2.9	1.2	0.3	0.3	0.039
N	NR	38.1	2.06	1.35	0.4	44.6	1.12	21	23	36	45.5	2.9	1.2	0.6	0.5	0.066
N	NR	44.6	2.46	1.35	0.4	52.7	1.12	22	25	42	53.5	3.3	1.2	1	0.5	0.115
—	—	—	—	—	—	—	—	23.5	30	55.5	—	—	—	—	—	0.27
—	—	—	—	—	—	—	—	21.6	22.3	25.4	—	—	—	—	—	0.0045
N	NR	30.7	1.3	0.95	0.25	34.8	0.85	22	22.5	30	35.5	1.9	0.9	0.3	0.3	0.019
N	NR	35.7	1.7	0.95	0.25	39.8	0.85	22	24	35	40.5	2.3	0.9	0.3	0.3	0.036
—	—	—	—	—	—	—	—	22	—	40	—	—	—	—	—	0.051
N	NR	39.75	2.06	1.35	0.4	46.3	1.12	24	26	38	47	2.9	1.2	0.6	0.5	0.069
N	NR	44.6	2.46	1.35	0.4	52.7	1.12	25	28	42	53.5	3.3	1.2	1	0.5	0.106
N	NR	49.73	2.46	1.35	0.4	57.9	1.12	26.5	28.5	45.5	58.5	3.3	1.2	1	0.5	0.144

Deep Groove Ball Bearings

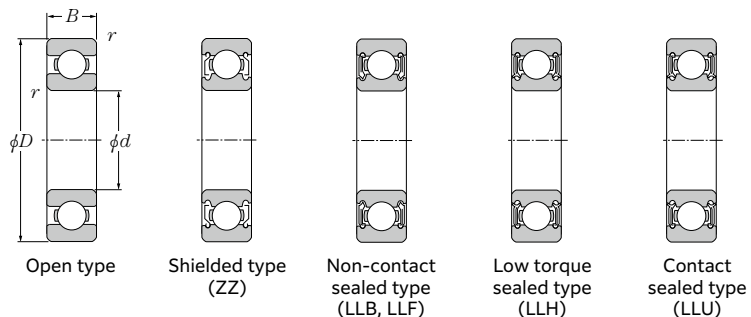

a 20 ~ 35mm

Boundary dimensions	Basic load rating		Fatigue load limit	Factor	Allowable speed				Bearing number								
	dynamic	static			Grease	Oil	Open type	Shielded or sealed type ²⁾	Open type	Shielded or sealed type ²⁾							
mm	kN	kN	kN		min ⁻¹	min ⁻¹	min ⁻¹	min ⁻¹	LLH	LLU	(See drawings)	(See drawings)					
d	D	B	r _{s min} ¹⁾	r _{NS}	C _r	C _{0r}	C _u	f ₀	Z, LB, LF	Z, LB, LF	LLH	LLU	LLB	LLH	LLU		
20	72	19	1.1	—	31.5	13.9	1.09	11.4	12 000	14 000	—	—	6404	ZZ	—	—	
22	44	12	0.6	0.5	10.4	5.05	0.395	13.9	17 000	20 000	13 000	10 000	60/22	ZZ	LLB	LLH	LLU
	50	14	1	0.5	14.3	6.80	0.500	13.5	14 000	17 000	12 000	9 700	62/22	ZZ	LLB	LLH	LLU
	56	16	1.1	0.5	20.4	9.25	0.725	12.4	13 000	15 000	11 000	9 200	63/22	ZZ	LLB	LLH	LLU
25	32	4	0.2	—	1.21	0.840	0.036	15.8	4 000	4 600	—	—	6705	—	LLF	—	—
	37	7	0.3	0.3	4.75	2.95	0.208	16.1	18 000	21 000	—	10 000	6805JR	ZZ	LLB	—	LLU
	42	9	0.3	0.3	7.80	4.55	0.345	15.4	16 000	19 000	11 700	9 800	6905	ZZ	LLB	LLH	LLU
	47	8	0.3	—	9.25	5.10	0.400	15.1	15 000	18 000	—	—	16005	—	—	—	—
	47	12	0.6	0.5	11.2	5.85	0.380	14.5	15 000	18 000	11 000	9 400	6005	ZZ	LLB	LLH	LLU
	52	15	1	0.5	15.5	7.85	0.550	13.9	13 000	15 000	11 000	8 900	6205	ZZ	LLB	LLH	LLU
	62	17	1.1	0.5	23.5	10.9	0.855	12.6	12 000	14 000	9 700	8 100	6305	ZZ	LLB	LLH	LLU
	80	21	1.5	—	38.5	17.5	1.36	11.6	10 000	12 000	—	—	6405	ZZ	—	—	—
28	52	12	0.6	0.5	13.8	7.40	0.580	14.5	14 000	16 000	10 000	8 400	60/28	ZZ	LLB	LLH	LLU
	58	16	1	0.5	19.8	9.75	0.720	13.4	12 000	14 000	9 700	8 100	62/28	ZZ	LLB	LLH	LLU
	68	18	1.1	0.5	29.6	14.0	1.10	12.4	11 000	13 000	8 900	7 400	63/28	ZZ	LLB	LLH	LLU
30	37	4	0.2	—	1.27	0.950	0.041	15.7	3 300	3 800	—	—	6706	—	LLF	—	—
	42	7	0.3	0.3	5.20	3.65	0.244	16.5	15 000	18 000	10 500	8 800	6806JR	ZZ	LLB	LLH	LLU
	47	9	0.3	0.3	8.00	5.00	0.365	15.8	14 000	17 000	10 000	8 400	6906	ZZ	LLB	LLH	LLU
	55	9	0.3	—	12.5	7.35	0.570	15.2	13 000	15 000	—	—	16006	—	—	—	—
	55	13	1	0.5	14.7	8.30	0.650	14.8	13 000	15 000	9 200	7 700	6006	ZZ	LLB	LLH	LLU
	62	16	1	0.5	21.6	11.3	0.795	13.8	11 000	13 000	8 800	7 300	6206	ZZ	LLB	LLH	LLU
	72	19	1.1	0.5	29.5	15.0	1.14	13.3	10 000	12 000	7 900	6 600	6306	ZZ	LLB	LLH	LLU
	90	23	1.5	—	48.0	23.9	1.86	12.3	8 800	10 000	—	—	6406	ZZ	—	—	—
32	58	13	1	0.5	13.1	8.05	0.615	15.4	12 000	15 000	8 700	7 200	60/32	ZZ	LLB	LLH	LLU
	65	17	1	0.5	23.0	11.6	0.840	13.6	11 000	12 000	8 400	7 100	62/32	ZZ	LLB	LLH	LLU
	75	20	1.1	0.5	33.0	16.9	1.30	13.1	9 500	11 000	7 700	6 500	63/32	ZZ	LLB	LLH	LLU
35	47	7	0.3	0.3	5.45	4.05	0.268	16.4	13 000	16 000	—	7 600	6807JR	ZZ	LLB	—	LLU
	55	10	0.6	0.5	10.6	6.85	0.495	15.8	12 000	15 000	8 500	7 100	6907	ZZ	LLB	LLH	LLU
	62	9	0.3	—	12.9	8.20	0.605	15.6	12 000	14 000	—	—	16007	—	—	—	—
	62	14	1	0.5	17.7	10.3	0.805	14.8	12 000	14 000	8 200	6 800	6007	ZZ	LLB	LLH	LLU
	72	17	1.1	0.5	28.4	15.3	1.09	13.8	9 800	11 000	7 600	6 300	6207	ZZ	LLB	LLH	LLU
	80	21	1.5	0.5	37.0	19.1	1.47	13.1	8 800	10 000	7 300	6 000	6307	ZZ	LLB	LLH	LLU
	100	25	1.5	—	61.0	31.0	2.43	12.3	7 800	9 100	—	—	6407	ZZ	—	—	—

1) Smallest allowable dimension for chamfer dimension r. 2) This bearing number is for double sealed and double shielded type bearings, but single sealed and single shielded type are also available. B-24

Deep Groove Ball Bearings

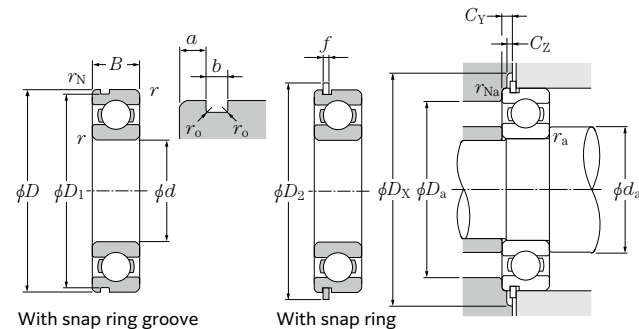

With snap ring groove

With snap ring

Dynamic equivalent radial load $P_r = X F_r + Y F_a$

$\frac{f_0 \cdot F_a}{C_{0r}}$	e	$\frac{F_a}{F_r} \leq e$		$\frac{F_a}{F_r} > e$	
		X	Y	X	Y
		0.172	0.19		
0.345	0.22				1.99
0.689	0.26				1.71
1.03	0.28				1.55
1.38	0.30	1	0	0.56	1.45
2.07	0.34				1.31
3.45	0.38				1.15
5.17	0.42				1.04
6.89	0.44				1.00

Static equivalent radial load

$P_{0r} = 0.6 F_r + 0.5 F_a$

When $P_{0r} < F_r$ use $P_{0r} = F_r$.

Bearing number	Snap ring groove dimensions			Snap ring dimensions		Installation-related dimensions								Mass ⁵⁾		
	mm		mm	mm		mm									kg	
Groove / Snap ring ³⁾ (See drawings)	D_1 Max.	a Max.	b Min.	r_o Max.	D_2 Max.	f Max.	d_a Min.	D_a Max. ⁴⁾	D_x (approx.)	C_Y Max.	C_Z Min.	r_{as} Max.	r_{Nas} Max. (approx.)			
—	—	—	—	—	—	—	26.5	35.5	65.5	—	—	—	—	0.4		
N	NR	41.75	2.06	1.35	0.4	48.3	1.12	26	26.5	40	49	2.9	1.2	0.6	0.5	0.074
N	NR	47.6	2.46	1.35	0.4	55.7	1.12	27	29.5	45	56.5	3.3	1.2	1	0.5	0.117
N	NR	53.6	2.46	1.35	0.4	61.7	1.12	28.5	31	49.5	62.5	3.3	1.2	1	0.5	0.176
—	—	—	—	—	—	—	—	26.6	27.3	30.4	—	—	—	0.2	—	0.005
N	NR	35.7	1.3	0.95	0.25	39.8	0.85	27	28	35	40.5	1.9	0.9	0.3	0.3	0.022
N	NR	40.7	1.7	0.95	0.25	44.8	0.85	27	29	40	45.5	2.3	0.9	0.3	0.3	0.042
—	—	—	—	—	—	—	—	27	—	45	—	—	—	0.3	—	0.06
N	NR	44.6	2.06	1.35	0.4	52.7	1.12	29	30.5	43	53.5	2.9	1.2	0.6	0.5	0.08
N	NR	49.73	2.46	1.35	0.4	57.9	1.12	30	32	47	58.5	3.3	1.2	1	0.5	0.128
N	NR	59.61	3.28	1.9	0.6	67.7	1.7	31.5	35	55.5	68.5	4.6	1.7	1	0.5	0.232
—	—	—	—	—	—	—	—	33	41	72	—	—	—	1.5	—	0.53
N	NR	49.73	2.06	1.35	0.4	57.9	1.12	32	34	48	58.5	2.9	1.2	0.6	0.5	0.098
N	NR	55.6	2.46	1.35	0.4	63.7	1.12	33	35.5	53	64.5	3.3	1.2	1	0.5	0.171
N	NR	64.82	3.28	1.9	0.6	74.6	1.7	34.5	38.5	61.5	76	4.6	1.7	1	0.5	0.284
—	—	—	—	—	—	—	—	31.6	32.3	35.4	—	—	—	0.2	—	0.006
N	NR	40.7	1.3	0.95	0.25	44.8	0.85	32	33	40	45.5	1.9	0.9	0.3	0.3	0.026
N	NR	45.7	1.7	0.95	0.25	49.8	0.85	32	34	45	50.5	2.3	0.9	0.3	0.3	0.048
—	—	—	—	—	—	—	—	32	—	53	—	—	—	0.3	—	0.091
N	NR	52.6	2.08	1.35	0.4	60.7	1.12	35	37	50	61.5	2.9	1.2	1	0.5	0.116
N	NR	59.61	3.28	1.9	0.6	67.7	1.7	35	39	57	68.5	4.6	1.7	1	0.5	0.199
N	NR	68.81	3.28	1.9	0.6	78.6	1.7	36.5	43	65.5	80	4.6	1.7	1	0.5	0.36
—	—	—	—	—	—	—	—	38	49	82	—	—	—	1.5	—	0.735
N	NR	55.6	2.08	1.35	0.4	63.7	1.12	37	39	53	64.5	2.9	1.2	1	0.5	0.129
N	NR	62.6	3.28	1.9	0.6	70										

Deep Groove Ball Bearings

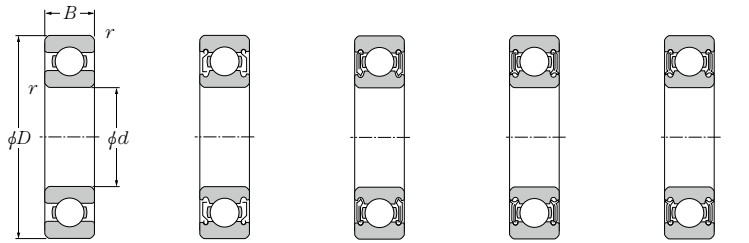

Open type Shielded type (ZZ) Non-contact sealed type (LLB) Low torque sealed type (LLH) Contact sealed type (LLU)

a 40 ~ 60mm

Boundary dimensions mm	Basic load rating dynamic static kN		Fatigue load limit kN	Factor f_0	Allowable speed min^{-1}				Bearing number												
	r_{NS} $r_{s \text{ min}}^{(1)}$ Min.	C_r			C_{0r}	C_u	Grease Open type, ZZ, LLB Z, LB	Oil Open type, LLH LLU	Open type	Shielded or sealed type ²⁾ (See drawings)											
d	D	B	r_{NS} $r_{s \text{ min}}^{(1)}$	C_r	C_{0r}	C_u	f_0														
40	52	7	0.3	0.3	5.65	4.40	0.291	16.3	12 000	14 000	8 000	6 700	6808JR	ZZ	LLB	LLH	LLU				
	62	12	0.6	0.5	13.5	8.90	0.645	15.8	11 000	13 000	7 500	6 300	6908	ZZ	LLB	LLH	LLU				
	68	9	0.3	—	14.0	9.65	0.685	16.0	10 000	12 000	—	—	16008	—	—	—	—				
	68	15	1	0.5	18.6	11.5	0.890	15.2	10 000	12 000	7 300	6 100	6008	ZZ	LLB	LLH	LLU				
	80	18	1.1	0.5	32.5	17.8	1.24	14.0	8 700	10 000	6 700	5 600	6208	ZZ	LLB	LLH	LLU				
	90	23	1.5	0.5	45.0	24.0	1.83	13.2	7 800	9 200	6 400	5 300	6308	ZZ	LLB	LLH	LLU				
	110	27	2	—	70.5	36.5	2.85	12.3	7 000	8 200	—	—	6408	ZZ	—	—	—				
45	58	7	0.3	0.3	5.95	4.95	0.325	16.1	11 000	12 000	—	5 900	6809JR	ZZ	LLB	—	LLU				
	68	12	0.6	0.5	14.5	10.4	0.730	16.1	9 800	12 000	—	5 600	6909	ZZ	LLB	—	LLU				
	75	10	0.6	—	14.3	10.5	0.725	16.2	9 200	11 000	—	—	16009	—	—	—	—				
	75	16	1	0.5	23.2	15.1	1.16	15.3	9 200	11 000	6 500	5 400	6009	ZZ	LLB	LLH	LLU				
	85	19	1.1	0.5	36.0	20.4	1.60	14.1	7 800	9 200	6 200	5 200	6209	ZZ	LLB	LLH	LLU				
	100	25	1.5	0.5	58.5	32.0	2.50	13.1	7 000	8 200	5 600	4 700	6309	ZZ	LLB	LLH	LLU				
	120	29	2	—	85.5	45.0	3.50	12.1	6 300	7 400	—	—	6409	ZZ	—	—	—				
50	65	7	0.3	0.3	7.30	6.10	0.405	16.1	9 600	11 000	—	5 300	6810JR	ZZ	LLB	—	LLU				
	72	12	0.6	0.5	14.9	11.2	0.765	16.3	8 900	11 000	6 100	5 100	6910	ZZ	LLB	LLH	LLU				
	80	10	0.6	—	14.7	11.3	0.760	16.4	8 400	9 800	—	—	16010	—	—	—	—				
	80	16	1	0.5	24.2	16.6	1.24	15.5	8 400	9 800	6 000	5 000	6010	ZZ	LLB	LLH	LLU				
	90	20	1.1	0.5	39.0	23.2	1.82	14.4	7 100	8 300	5 700	4 700	6210	ZZ	LLB	LLH	LLU				
	110	27	2	0.5	68.5	38.5	2.99	13.2	6 400	7 500	5 000	4 200	6310	ZZ	LLB	LLH	LLU				
	130	31	2.1	—	92.0	49.5	3.85	12.5	5 700	6 700	—	—	6410	ZZ	—	—	—				
55	72	9	0.3	0.3	9.75	8.10	0.540	16.2	8 700	10 000	—	4 800	6811JR	ZZ	LLB	—	LLU				
	80	13	1	0.5	17.7	13.3	0.915	16.2	8 200	9 600	5 500	4 600	6911	ZZ	LLB	LLH	LLU				
	90	11	0.6	—	20.6	15.3	1.06	16.2	7 700	9 000	—	—	16011	—	—	—	—				
	90	18	1.1	0.5	31.5	21.2	1.62	15.3	7 700	9 000	—	4 500	6011	ZZ	LLB	—	LLU				
	100	21	1.5	0.5	48.0	29.2	2.29	14.3	6 400	7 600	—	4 300	6211	ZZ	LLB	—	LLU				
	120	29	2	0.5	79.5	45.0	3.50	13.2	5 800	6 800	—	3 900	6311	ZZ	LLB	—	LLU				
	140	33	2.1	—	98.5	54.0	4.20	12.7	5 200	6 100	—	—	6411	ZZ	—	—	—				
60	78	10	0.3	0.3	12.7	10.6	0.705	16.3	8 000	9 400	—	4 400	6812	ZZ	LLB	—	LLU				
	85	13	1	0.5	18.2	14.3	0.965	16.4	7 600	8 900	—	4 300	6912	ZZ	LLB	—	LLU				
	95	11	0.6	—	22.1	17.5	1.20	16.3	7 000	8 300	—	—	16012	—	—	—	—				
	95	18	1.1	0.5	32.5	23.2	1.73	15.6	7 000	8 300	—	4 100	6012	ZZ	LLB	—	LLU				
	110	22	1.5	0.5	58.0	36.0	2.83	14.3	6 000	7 000	4 500	3 800	6212	ZZ	LLB	LLH	LLU				
	130	31	2.1	0.5	90.5	52.0	4.10	13.2	5 400	6 300	—	3 600	6312	ZZ	LLB	—	LLU				
	150	35	2.1	—	113	64.5	4.90	12.6	4 800	5 700	—	—	6412	ZZ	—	—	—				

1) Smallest allowable dimension for chamfer dimension r . 2) This bearing number is for double sealed and double shielded type bearings, but single sealed and single shielded type are also available. B-26

Deep Groove Ball Bearings

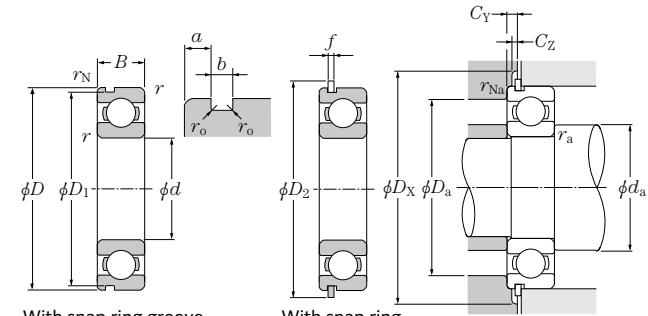

With snap ring groove

With snap ring

Dynamic equivalent radial load
 $P_r = X F_r + Y F_a$

$f_0 \cdot F_r / C_{0r}$	e	$F_a / F_r \leq e$		$F_a / F_r > e$	
		X	Y	X	Y
0.172	0.19				2.30
0.345	0.22				1.99
0.689	0.26				1.71
1.03	0.28				1.55
1.38	0.30				1.45
2.07	0.34				1.31
3.45	0.38	1	0	0.56	1.15
5.17	0.42				1.04
6.89	0.44				1.00

Static equivalent radial load
 $P_{0r} = 0.6 F_r + 0.5 F_a$

When $P_{0r} < F_r$ use $P_{0r} = F_r$.

Bearing number	Snap ring groove dimensions mm			Snap ring dimensions mm		Installation-related dimensions mm							Mass ⁵⁾ kg			
	D_1 Max.	a Max.	b Min.	r_o Max.	D_2 Max.	f Max.	d_a Min.	D_a Max. ⁴⁾	D_x (approx.)	C_Y Max.	C_Z Min.	r_{as} Max.		r_{Nas} Max. (approx.)		
N	NR	50.7	1.3	0.95	0.25	54.8	0.85	42	43	50	55.5	1.9	0.9	0.3	0.3	0.033
N	NR	60.7	1.7	0.95	0.25	64.8	0.85	44	45	58	65.5	2.3	0.9	0.6	0.5	0.11
—	—	—	—	—	—	—	—	42	—	66	—	—	—	0.3	—	0.125
N	NR	64.82	2.49	1.9	0.6	74.6	1.7	45	47	63	76	3.8	1.7	1	0.5	0.19
N	NR	76.81	3.28	1.9	0.6	86.6	1.7	46.5	51	73.5	88	4.6	1.7	1	0.5	0.366
N	NR	86.79	3.28	2.7	0.6	96.5	2.46	48	54	82	98	5.4	2.5	1.5	0.5	0.63
—	—	—	—	—	—	—	—	49	—	61.5	101	—	—	2.0	—	1.23
N	NR	56.7	1.3	0.95	0.25	60.8	0.85	47	48	56	61.5	1.9	0.9	0.3	0.3	0.04
N	NR	66.7	1.7	0.95	0.25	70.8	0.85	49	51	64	72	2.3	0.9	0.6	0.5	0.128
—	—	—	—	—	—	—	—	49	—	71	—	—	—	0.6	—	0.171
N	NR	71.83	2.49	1.9	0.6	81.6	1.7	50	52	70	83	3.8	1.7	1	0.5	0.237
N	NR	81.81	3.28	1.9	0.6	91.6	1.7	51.5	55.5	78.5	93	4.6	1.7	1	0.5	0.398
N	NR	96.8	3.28	2.7	0.6	106.5	2.46	53	61.5	92	108	5.4	2.5	1.5	0.5	0.814
—	—	—	—	—	—	—	—	54	—	66.5	111	—	—	2	—	1.53
N	NR	63.7	1.3	0.95	0.25	67.8	0.85	52	54	63	68.5	1.9	0.9	0.3	0.3	0.052
N	NR	70.7	1.7	0.95	0.25	74.8	0.85	54	55.5	68	76	2.3	0.9	0.6	0.5	0.132
—	—	—	—	—	—	—	—	54	—	76	—	—	—	0.6	—	0.18
N	NR	76.81	2.49	1.9	0.6	86.6	1.7	55	57.5	75	88	3.8	1.7	1	0.5	0.261
N	NR	86.79	3.28	2.7	0.6	96.5	2.46	56.5	60	83.5	98	5.4	2.5	1	0.5	0.454
N	NR	106.81	3.28	2.7	0.6	116.6	2.46	59	68.5	101	118	5.4	2.5	2	0.5	1.07
—	—	—	—	—	—	—	—	61	—	73.5	119	—	—	2	—	1.88
N	NR	70.7	1.7	0.95	0.25	74.8	0.85	57	59	70	76	2.3	0.9	0.3	0.3	0.083
N	NR	77.9	2.1	1.3	0.4	84.4	1.12	60	61.5	75	86	2.9	1.2	1	0.5	0.18
—	—	—	—	—	—	—	—	59	—	86	—	—	—	0.6	—	0.258
N	NR	86.79	2.87	2.7	0.6	96.5	2.46	61.5	64	83.5	98	5	2.5	1	0.5	0.388
N	NR	96.8	3.28	2.7	0.6	106.5	2.46	63	67	92	108	5.4	2.5	1.5	0.5	0.601
N	NR	115.21	4.06	3.1	0.6	129.7	2.82	64	74	111	131.5	6.5	2.9	2	0.5	1.37
—	—	—	—	—	—	—	—	66	—	80	129	—	—	2	—	2.29
N	NR	76.2	1.7	1.3	0.4											

Deep Groove Ball Bearings

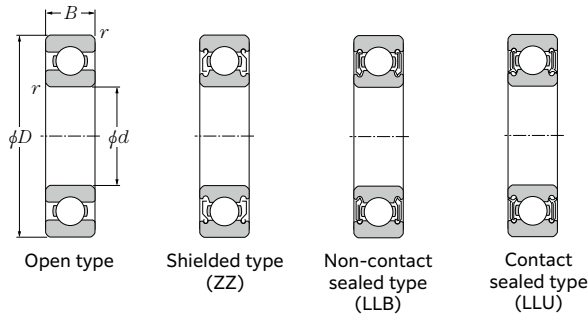

d 65 ~ 85mm

	Boundary dimensions				Basic load rating		Fatigue load limit kN C_u	Factor f_0	Allowable speed min^{-1}			Bearing number			
	mm				dynamic kN	static kN			Grease ZZ, LLB Z, LB	Oil Open type, Open type, Z, LB	LLU	Open type	Shielded or sealed type ²⁾ (See drawings)		
	<i>d</i>	<i>D</i>	<i>B</i>	$r_{s \text{ min}}^{(1)}$	C_r	C_{0r}									
65	85	10	0.6	0.5	12.8	11.0	0.730	16.2	7 400	8 700	4 100	6813	ZZ	LLB	LLU
	90	13	1	0.5	19.3	16.1	1.07	16.6	7 000	8 200	4 000	6913	ZZ	LLB	LLU
	100	11	0.6	—	22.7	18.7	1.26	16.5	6 500	7 700	—	16013	—	—	—
	100	18	1.1	0.5	34.0	25.2	1.83	15.8	6 500	7 700	3 900	6013	ZZ	LLB	LLU
	120	23	1.5	0.5	63.5	40.0	3.15	14.4	5 500	6 500	3 600	6213	ZZ	LLB	LLU
	140	33	2.1	0.5	103	60.0	4.60	13.2	4 900	5 800	3 300	6313	ZZ	LLB	LLU
	160	37	2.1	—	123	72.5	5.35	12.7	4 400	5 200	—	6413	—	—	—
70	90	10	0.6	0.5	13.4	11.9	0.795	16.1	6 900	8 100	3 800	6814	ZZ	LLB	LLU
	100	16	1	0.5	26.3	21.2	1.45	16.3	6 500	7 700	3 700	6914	ZZ	LLB	LLU
	110	13	0.6	—	27.0	22.6	1.52	16.5	6 100	7 100	—	16014	—	—	—
	110	20	1.1	0.5	42.0	31.0	2.30	15.6	6 100	7 100	3 600	6014	ZZ	LLB	LLU
	125	24	1.5	0.5	69.0	44.0	3.45	14.5	5 100	6 000	3 400	6214	ZZ	LLB	LLU
	150	35	2.1	0.5	115	68.0	5.10	13.2	4 600	5 400	3 100	6314	ZZ	LLB	LLU
	180	42	3	—	142	89.5	6.25	12.7	4 100	4 800	—	6414	—	—	—
75	95	10	0.6	0.5	13.9	12.9	0.855	16.0	6 400	7 600	3 600	6815	ZZ	LLB	LLU
	105	16	1	0.5	27.0	22.6	1.52	16.5	6 100	7 200	3 500	6915	ZZ	LLB	LLU
	115	13	0.6	—	27.6	24.0	1.60	16.6	5 700	6 700	—	16015	—	—	—
	115	20	1.1	0.5	44.0	33.5	2.44	15.8	5 700	6 700	3 300	6015	ZZ	LLB	LLU
	130	25	1.5	0.5	73.5	49.5	3.80	14.7	4 800	5 600	3 200	6215	ZZ	LLB	LLU
	160	37	2.1	0.5	126	77.0	5.55	13.2	4 300	5 000	2 900	6315	ZZ	LLB	LLU
	190	45	3	—	152	99.0	6.70	12.7	3 800	4 500	—	6415	—	—	—
80	100	10	0.6	0.5	14.0	13.3	0.885	16.0	6 000	7 100	3 400	6816	ZZ	LLB	LLU
	110	16	1	0.5	27.6	24.0	1.59	16.6	5 700	6 700	3 200	6916	ZZ	LLB	LLU
	125	14	0.6	—	28.1	25.1	1.64	16.4	5 300	6 200	—	16016	—	—	—
	125	22	1.1	0.5	53.0	40.0	2.91	15.6	5 300	6 200	3 100	6016	ZZ	LLB	LLU
	140	26	2	0.5	80.5	53.0	3.95	14.6	4 500	5 300	3 000	6216	ZZ	LLB	LLU
	170	39	2.1	0.5	136	86.5	6.05	13.3	4 000	4 700	2 700	6316	ZZ	LLB	LLU
	200	48	3	—	181	125	8.20	12.3	3 600	4 200	—	6416	—	—	—
85	110	13	1	0.5	20.7	19.0	1.26	16.2	5 700	6 700	3 100	6817	ZZ	LLB	LLU
	120	18	1.1	0.5	35.5	29.6	1.99	16.4	5 400	6 300	3 000	6917	ZZ	LLB	LLU
	130	14	0.6	—	28.7	26.2	1.68	16.4	5 000	5 900	—	16017	—	—	—
	130	22	1.1	0.5	55.0	43.0	3.00	15.8	5 000	5 900	2 900	6017	ZZ	LLB	LLU
	150	28	2	0.5	92.0	64.0	4.60	14.7	4 200	5 000	2 800	6217	ZZ	LLB	LLU
	180	41	3	0.5	147	97.0	6.55	13.3	3 800	4 500	2 600	6317	ZZ	LLB	LLU

1) Smallest allowable dimension for chamfer dimension *r*. 2) This bearing number is for double sealed and double shielded type bearings, but single sealed and single shielded type are also available. B-28

Deep Groove Ball Bearings

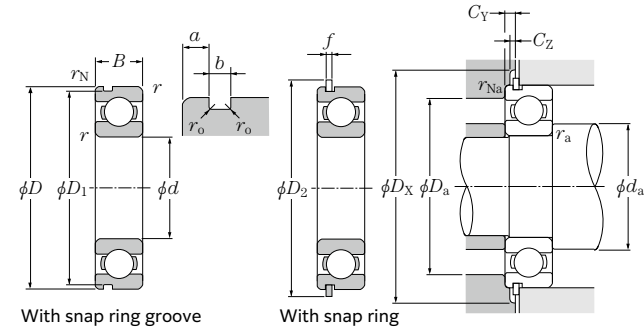

Dynamic equivalent radial load
 $P_r = XF_r + YF_a$

$\frac{f_0 \cdot F_a}{C_{0r}}$	<i>e</i>	$\frac{F_a}{F_r} \leq e$		$\frac{F_a}{F_r} > e$	
		<i>X</i>	<i>Y</i>	<i>X</i>	<i>Y</i>
		0.172	0.19	—	—
0.345	0.22	—	—	—	1.99
0.689	0.26	—	—	—	1.71
1.03	0.28	—	—	—	1.55
1.38	0.30	1	0	0.56	1.45
2.07	0.34	—	—	—	1.31
3.45	0.38	—	—	—	1.15
5.17	0.42	—	—	—	1.04
6.89	0.44	—	—	—	1.00

Static equivalent radial load
 $P_{0r} = 0.6F_r + 0.5F_a$

When $P_{0r} < F_r$ use $P_{0r} = F_r$.

Bearing number	Snap ring groove dimensions mm	Snap ring dimensions mm	Installation-related dimensions											Mass ⁵⁾ kg		
			mm													
			<i>D</i> ₁ Max.	<i>a</i> Max.	<i>b</i> Min.	<i>r</i> _o Max.	<i>D</i> ₂ Max.	<i>f</i> Max.	<i>d</i> _a Min.	<i>D</i> _a Max. ⁴⁾	<i>D</i> _x (approx.)	<i>C</i> _Y Max.	<i>C</i> _Z Min.		<i>r</i> _{as} Max.	<i>r</i> _{Nas} Max. (approx.)
N	NR	82.9	1.7	1.3	0.4	89.4	1.12	69	70	81	91	2.5	1.2	0.6	0.5	0.128
N	NR	87.9	2.1	1.3	0.4	94.4	1.12	70	71.5	85	96	2.9	1.2	1	0.5	0.206
—	—	—	—	—	—	—	—	69	—	96	—	—	—	0.6	—	0.307
N	NR	96.8	2.87	2.7	0.6	106.5	2.46	71.5	74	93.5	108	5	2.5	1	0.5	0.421
N	NR	115.21	4.06	3.1	0.6	129.7	2.82	73	80.5	112	131.5	6.5	2.9	1.5	0.5	0.99
N	NR	135.23	4.9	3.1	0.6	149.7	2.82	76	86	129	152	7.3	2.9	2	0.5	2.08
—	—	—	—	—	—	—	—	76	—	149	—	—	—	2	—	3.3
N	NR	87.9	1.7	1.3	0.4	94.4	1.12	74	75.5	86	96	2.5	1.2	0.6	0.5	0.137
N	NR	97.9	2.5	1.3	0.4	104.4	1.12	75	77.5	95	106	3.3	1.2	1	0.5	0.334
—	—	—	—	—	—	—	—	74	—	106	—	—	—	0.6	—	0.441
N	NR	106.81	2.87	2.7	0.6	116.6	2.46	76.5	80.5	103.5	118	5	2.5	1	0.5	0.604
N	NR	120.22	4.06	3.1	0.6	134.7	2.82	78	85	117	136.5	6.5	2.9	1.5	0.5	1.07
N	NR	145.24	4.9	3.1	0.6	159.7	2.82	81	92.5	139	162	7.3	2.9	2	0.5	2.52
—	—	—	—	—	—	—	—	83	—	167	—	—	—	2.5	—	4.83
N	NR	92.9	1.7	1.3	0.4	99.4	1.12	79	80	91	101	2.5	1.2	0.6	0.5	0.145
N	NR	102.6	2.5	1.3	0.4	110.7	1.12	80	82.5	100	112	3.3	1.2	1	0.5	0.353
—	—	—	—	—	—	—	—	79	—	111	—	—	—	0.6	—	0.464
N	NR	111.81	2.87	2.7	0.6	121.6	2.46	81.5	85.5	108.5	123	5	2.5	1	0.5	0.649
N	NR	125.22	4.06	3.1	0.6	139.7	2.82	83	90.5	122	141.5	6.5	2.9	1.5	0.5	1.18
N	NR	155.22	4.9	3.1	0.6	169.7	2.82	86	99	149	172	7.3	2.9	2	0.5	3.02
—	—	—	—	—	—	—	—	88	—	177	—	—	—	2.5	—	5.72
N	NR	97.9	1.7	1.3	0.4	104.4	1.12	84	85	96	106	2.5	1.2	0.6	0.5	0.154
N	NR	107.6	2.5	1.3	0.4	115.7	1.12	85	88	105	117	3.3	1.2	1	0.5	0.373
—	—	—	—	—	—	—	—	84	—	121	—	—	—	0.6	—	0.597
N	NR	120.22	2.87	3.1	0.6	134.7	2.82	86.5	91.5	118.5	136.5	5.3	2.9	1	0.5	0.854
N	NR	135.23	4.9	3.1	0.6	149.7	2.82	89	95.5	131	152	7.3	2.9	2	0.5	1.4
N	NR	163.65	5.69	3.5	0.6	182.9	3.1	91	105	159	185	8.4	3.1	2	0.5	3.59
—	—	—	—	—	—	—	—	93	—	187	—	—	—	2.5	—	6.76
N	NR	107.6	2.1	1.3	0.4	115.7	1.12	90	91	105	117	2.9	1.2	1	0.5	0.27
N	NR	117.6	3.3	1.3	0.4	125.7	1.12	91.5	94	113.5	127	4.1	1.2	1	0.5	0.536
—	—	—	—	—	—	—	—	89	—	126	—	—	—	0.6	—	0.626
N	NR	125.22	2.87	3.1	0.6	139.7	2.82	91.5	97	123.5	141.5	5.3	2.9	1	0.5	0.89
N	NR	145.24	4.9	3.1	0.6	159.7	2.82	94	103	141	162	7.3	2.9	2	0.5	1.79
N	NR	173.66	5.69	3.5	0.6	192.9	3.1	98	112	167	195	8.4	3.1	2.5	0.5	4.23

3) Sealed and shielded bearings are also available. 4) This dimension applies to sealed and shielded bearings. 5) Does not include bearings with snap rings. B-29

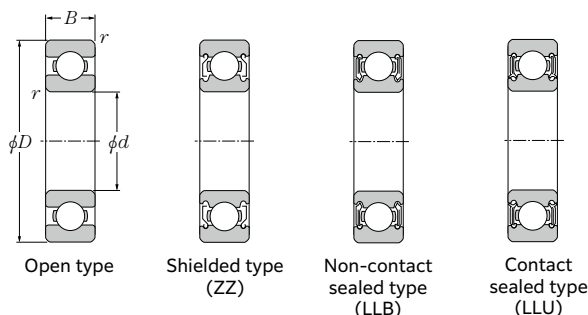

d 90 ~ 120mm

	Boundary dimensions				Basic load rating			Factor f_0	Allowable speed			Bearing number			
	mm				dynamic kN	static kN	Fatigue load limit kN		Grease	Oil	Open type	or sealed type ²⁾			
	d	D	B	$r_{s\ min}^{1)}$	r_{NS} Min.	C_r	C_{0r}	C_u	Open type ZZ, LLB	Oil Open type Z, LB		LLU	Open type	Shielded	LLU
90	115	13	1	0.5	21.1	19.7	1.30	16.1	5 400	6 300	3 000	6818	ZZ	LLB	LLU
	125	18	1.1	0.5	36.5	31.5	2.05	16.5	5 100	6 000	2 900	6918	ZZ	LLB	LLU
	140	16	1	—	37.0	33.5	2.07	16.5	4 700	5 600	—	16018	—	—	—
	140	24	1.5	0.5	64.5	49.5	3.45	15.6	4 700	5 600	2 800	6018	ZZ	LLB	LLU
	160	30	2	0.5	106	71.5	5.00	14.5	4 000	4 700	2 600	6218	ZZ	LLB	LLU
	190	43	3	0.5	158	107	7.10	13.3	3 600	4 200	2 400	6318	ZZ	LLB	LLU
95	120	13	1	0.5	21.4	20.5	1.31	16.1	5 000	5 900	2 800	6819	ZZ	LLB	LLU
	130	18	1.1	0.5	37.5	33.5	2.10	16.6	4 800	5 700	2 800	6919	ZZ	LLB	LLU
	145	16	1	—	38.0	35.0	2.13	16.5	4 500	5 300	—	16019	—	—	—
	145	24	1.5	0.5	67.0	54.0	3.55	15.8	4 500	5 300	2 600	6019	ZZ	LLB	LLU
	170	32	2.1	0.5	121	82.0	5.55	14.4	3 700	4 400	2 500	6219	ZZ	LLB	LLU
	200	45	3	0.5	169	119	7.65	13.3	3 300	3 900	2 300	6319	ZZ	LLB	LLU
100	125	13	1	0.5	21.7	21.2	1.33	16.0	4 800	5 600	2 700	6820	ZZ	LLB	LLU
	140	20	1.1	0.5	45.5	39.5	2.44	16.4	4 500	5 300	2 600	6920	ZZ	LLB	LLU
	150	16	1	—	39.0	36.5	2.18	16.4	4 200	5 000	—	16020	—	—	—
	150	24	1.5	0.5	66.5	54.0	3.50	15.9	4 200	5 000	2 600	6020	ZZ	LLB	LLU
	180	34	2.1	0.5	135	93.0	6.15	14.4	3 500	4 200	2 300	6220	ZZ	LLB	LLU
	215	47	3	—	192	141	8.75	13.2	3 200	3 700	2 200	6320	ZZ	LLB	LLU
105	130	13	1	0.5	22.0	22.0	1.35	15.9	4 600	5 400	2 500	6821	ZZ	—	LLU
	145	20	1.1	0.5	47.0	42.0	2.52	16.5	4 300	5 100	2 500	6921	ZZ	LLB	LLU
	160	18	1	—	57.5	50.5	3.00	16.3	4 000	4 700	—	16021	—	—	—
	160	26	2	0.5	80.5	65.5	4.15	15.8	4 000	4 700	2 400	6021	ZZ	LLB	LLU
	190	36	2.1	0.5	147	105	6.75	14.4	3 400	4 000	2 300	6221	ZZ	LLB	LLU
	225	49	3	—	204	153	9.35	13.2	3 000	3 600	2 100	6321	ZZ	—	LLU
110	140	16	1	0.5	27.5	28.2	1.68	16.0	4 300	5 100	2 400	6822	ZZ	LLB	LLU
	150	20	1.1	0.5	48.5	44.5	2.60	16.6	4 100	4 800	2 400	6922	ZZ	LLB	LLU
	170	18	1	—	63.5	56.5	3.25	16.3	3 800	4 500	—	16022	—	—	—
	170	28	2	0.5	91.0	73.0	4.55	15.6	3 800	4 500	2 300	6022	ZZ	LLB	LLU
	200	38	2.1	0.5	160	117	7.35	14.3	3 200	3 800	2 200	6222	ZZ	LLB	LLU
	240	50	3	—	227	179	10.5	13.1	2 900	3 400	1 900	6322	ZZ	LLB	LLU
120	150	16	1	0.5	32.0	33.0	1.89	16.0	4 000	4 700	2 200	6824	ZZ	LLB	LLU
	165	22	1.1	0.5	59.0	54.0	3.05	16.5	3 800	4 400	2 100	6924	ZZ	—	LLU
	180	19	1	—	70.0	63.5	3.50	16.4	3 500	4 100	—	16024	—	—	—
	180	28	2	0.5	94.0	79.5	4.65	15.9	3 500	4 100	2 100	6024	ZZ	LLB	LLU

1) Smallest allowable dimension for chamfer dimension r . 2) This bearing number is for double sealed and double shielded type bearings, but single sealed and single shielded type are also available.

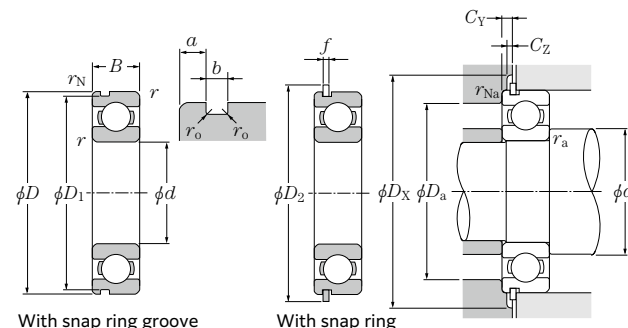

With snap ring groove

With snap ring

Dynamic equivalent radial load $P_r = X F_r + Y F_a$

$\frac{f_0 \cdot F_a}{C_{0r}}$	e	$\frac{F_a}{F_r} \leq e$		$\frac{F_a}{F_r} > e$	
		X	Y	X	Y
0.172	0.19				2.30
0.345	0.22				1.99
0.689	0.26				1.71
1.03	0.28				1.55
1.38	0.30	1	0	0.56	1.45
2.07	0.34				1.31
3.45	0.38				1.15
5.17	0.42				1.04
6.89	0.44				1.00

Static equivalent radial load $P_{0r} = 0.6 F_r + 0.5 F_a$

When $P_{0r} < F_r$ use $P_{0r} = F_r$.

Bearing number	Snap ring groove dimensions mm	Snap ring dimensions mm	Installation-related dimensions										Mass ⁵⁾ kg			
			mm													
Groove / Snap ring ³⁾ (See drawings)	D_1 Max.	a Max.	b Min.	r_o Max.	D_2 Max.	f Max.	d_a Min.	D_a Max. ⁴⁾	D_X (approx.)	C_Y Max.	C_Z Min.	r_{as} Max.	r_{nas} Max.	(approx.)		
N	NR	112.6	2.1	1.3	0.4	120.7	1.12	95	96	110	122	2.9	1.2	1	0.5	0.285
N	NR	122.6	3.3	1.3	0.4	130.7	1.12	96.5	99	118.5	132	4.1	1.2	1	0.5	0.554
—	—	—	—	—	—	—	—	95	—	135	—	—	—	1	—	0.848
N	NR	135.23	3.71	3.1	0.6	149.7	2.82	98	102	132	152	6.1	2.9	1.5	0.5	1.02
N	NR	155.22	4.9	3.1	0.6	169.7	2.82	99	109	151	172	7.3	2.9	2	0.5	2.15
N	NR	183.64	5.69	3.5	0.6	202.9	3.1	103	118	177	205	8.4	3.1	2.5	0.5	4.91
N	NR	117.6	2.1	1.3	0.4	125.7	1.12	100	101	115	127	2.9	1.2	1	0.5	0.3
N	NR	127.6	3.3	1.3	0.4	135.7	1.12	101.5	104	123.5	137	4.1	1.2	1	0.5	0.579
—	—	—	—	—	—	—	—	100	—	140	—	—	—	1	—	0.885
N	NR	140.23	3.71	3.1	0.6	154.7	2.82	103	109	137	157	6.1	2.9	1.5	0.5	1.08
N	NR	163.65	5.69	3.5	0.6	182.9	3.1	106	116	159	185	8.4	3.1	2	0.5	2.62
N	NR	193.65	5.69	3.5	0.6	212.9	3.1	108	125	187	215	8.4	3.1	2.5	0.5	5.67
N	NR	122.6	2.1	1.3	0.4	130.7	1.12	105	106	120	132	2.9	1.2	1	0.5	0.313
N	NR	137.6	3.3	1.9	0.6	145.7	1.7	106.5	110	133.5	147	4.7	1.7	1	0.5	0.785
—	—	—	—	—	—	—	—	105	—	145	—	—	—	1	—	0.91
N	NR	145.24	3.71	3.1	0.6	159.7	2.82	108	110	142	162	6.1	2.9	1.5	0.5	1.15
N	NR	173.66	5.69	3.5	0.6	192.9	3.1	111	122	169	195	8.4	3.1	2	0.5	3.14
N	NR	208.6	5.69	3.5	1	227.8	3.1	113	133	202	230	8.4	3.1	2.5	0.5	7
N	NR	127.6	2.1	1.3	0.4	135.7	1.12	110	111	125	137	2.9	1.2	1	0.5	0.33
N	NR	142.6	3.3	1.9	0.6	150.7	1.7	111.5	115	138.5	152	4.7	1.7	1	0.5	0.816
—	—	—	—	—	—	—	—	110	—	155	—	—	—	1	—	1.2
N	NR	155.22	3.71	3.1	0.6	169.7	2.82	114	119	151	172	6.1	2.9	2	0.5	1.59
N	NR	183.64	5.69	3.5	0.6	202.9	3.1	116	125	179	205	8.4	3.1	2	0.5	3.7
N	NR	217.0	6.5	4.5	1	237	3.5	118	134	212	239	9.6	3.5	2.5	0.5	8.05
N	NR	137.6	2.5	1.9	0.6	145.7	1.7	115	118	135	147	3.9	1.7	1	0.5	0.515
N	NR	147.6	3.3	1.9	0.6	155.7	1.7	116.5	120	143.5	157	4.7	1.7	1	0.5	0.849
—	—	—	—	—	—	—	—	115	—	165	—	—	—	1	—	1.46
N	NR	163.65	3.71	3.5	0.6	182.9	3.1	119	126	161	185	6.4	3.1	2	0.5	1.96
N	NR	193.65	5.69	3.5	0.6	212.9	3.1	121	132	189	215	8.4	3.1	2	0.5	4.36
N	NR	232.0	6.5	4.5	1	252	3.5	123	149	227	254	9.6	3.5	2.5	0.5	9.54
N	NR	147.6	2.5	1.9	0.6	155.7	1.7	125	128	145	157	3.9	1.7	1	0.5	0.555
N	NR	161.8	3.7	1.9	0.6	171.5	1.7	126.5	132	158.5	173	5.1	1.7	1	0.5	1.15
—	—	—	—	—	—	—	—	125	—	175	—	—	—	1	—	1.56
N	NR	173.66	3.71	3.5	0.6	192.9	3.1	129	136	171	195	6.4	3.1	2	0.5	2.07

3) Sealed and shielded bearings are also available. 4) This dimension applies to sealed and shielded bearings. 5) Does not include bearings with snap rings.

● Deep Groove Ball Bearings

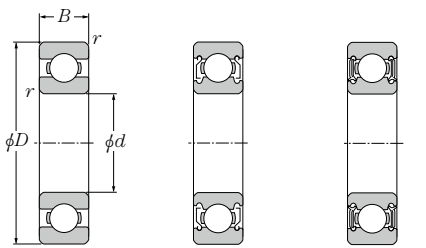
Open type
Shielded type (ZZ)
Contact sealed type (LLU)

d 120 ~ 170mm

	Boundary dimensions				Basic load rating		Fatigue load limit kN	Factor f_0	Allowable speed min ⁻¹			Bearing number		
	mm				dynamic kN	static kN			Grease	Oil	LLU	Open type	Shielded or sealed type ²⁾	LLU
	d	D	B	$r_{s\ min}^{1)}$	$r_{NS\ Min.}$	C_r	C_{0r}	C_u	Open type, ZZ, Z	Open type, Z		Open type	Shielded or sealed type ²⁾ (See drawings)	
120	215	40	2.1	—	172	131	7.95	14.4	2 900	3 400	2 000	6224	ZZ	LLU
	260	55	3	—	229	185	10.5	13.5	2 600	3 100	1 700	6324	ZZ	LLU
130	165	18	1.1	0.5	41.0	41.0	2.25	16.1	3 700	4 300	2 000	6826	ZZ	LLU
	180	24	1.5	0.5	72.0	67.5	3.65	16.5	3 500	4 100	1 900	6926	ZZ	LLU
	200	22	1.1	—	88.5	79.5	4.25	16.2	3 200	3 800	—	16026	—	—
	200	33	2	0.5	118	101	5.70	15.8	3 200	3 800	1 900	6026	ZZ	LLU
	230	40	3	—	185	146	8.55	14.5	2 700	3 100	1 800	6226	ZZ	LLU
	280	58	4	—	254	214	11.7	13.6	2 400	2 800	—	6326	—	—
140	175	18	1.1	0.5	42.5	44.5	2.35	16.0	3 400	4 000	1 900	6828	ZZ	LLU
	190	24	1.5	0.5	74.0	71.5	3.70	16.6	3 200	3 800	1 800	6928	ZZ	LLU
	210	22	1.1	—	91.0	85.0	4.35	16.4	3 000	3 500	—	16028	—	—
	210	33	2	—	122	109	5.85	15.9	3 000	3 500	1 800	6028	ZZ	LLU
	250	42	3	—	184	150	8.40	14.8	2 500	2 900	1 600	6228	ZZ	LLU
	300	62	4	—	280	246	13.0	13.6	2 200	2 600	—	6328	—	—
150	190	20	1.1	0.5	53.0	55.0	2.80	16.1	3 100	3 700	1 700	6830	ZZ	LLU
	210	28	2	—	94.0	90.5	4.55	16.5	3 000	3 500	1 700	6930	ZZ	LLU
	225	24	1.1	—	107	101	5.00	16.4	2 800	3 200	—	16030	—	—
	225	35	2.1	—	139	126	6.55	15.9	2 800	3 200	1 700	6030	ZZ	LLU
	270	45	3	—	195	168	9.05	15.1	2 300	2 700	1 500	6230	ZZ	LLU
	320	65	4	—	305	284	14.5	13.9	2 100	2 400	—	6330	—	—
160	200	20	1.1	0.5	53.5	57.0	2.82	16.1	2 900	3 400	1 600	6832	ZZ	LLU
	220	28	2	—	96.5	96.0	4.65	16.6	2 800	3 300	—	6932	ZZ	LLU
	240	25	1.5	—	109	108	5.10	16.5	2 600	3 000	—	16032	—	—
	240	38	2.1	—	158	144	7.30	15.9	2 600	3 000	1 600	6032	ZZ	LLU
	290	48	3	—	205	186	9.45	15.4	2 100	2 500	—	6232	—	—
	340	68	4	—	310	286	14.2	13.9	1 900	2 300	—	6332	—	—
170	215	22	1.1	—	66.5	70.5	3.35	16.1	2 700	3 200	—	6834	ZZ	—
	230	28	2	—	95.0	95.5	4.50	16.5	2 600	3 100	—	6934	ZZ	—
	260	28	1.5	—	131	128	5.90	16.4	2 400	2 800	—	16034	—	—
	260	42	2.1	—	187	172	8.55	15.8	2 400	2 800	—	6034	ZZ	—
	310	52	4	—	235	223	11.1	15.3	2 000	2 400	—	6234	—	—
	360	72	4	—	360	355	17.0	13.6	1 800	2 100	—	6334	—	—

1) Smallest allowable dimension for chamfer dimension r . 2) This bearing number is for double sealed and double shielded type bearings, but single sealed and single shielded type are also available. B-32

● Deep Groove Ball Bearings

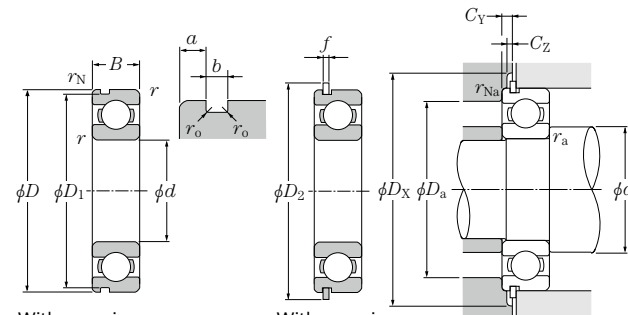
With snap ring groove
With snap ring

Dynamic equivalent radial load

$$P_r = X F_r + Y F_a$$

$\frac{f_0 \cdot F_a}{C_{0r}}$	e	$\frac{F_a}{F_r} \leq e$		$\frac{F_a}{F_r} > e$	
		X	Y	X	Y
0.172	0.19				2.30
0.345	0.22				1.99
0.689	0.26				1.71
1.03	0.28				1.55
1.38	0.30	1	0	0.56	1.45
2.07	0.34				1.31
3.45	0.38				1.15
5.17	0.42				1.04
6.89	0.44				1.00

Static equivalent radial load

$$P_{0r} = 0.6 F_r + 0.5 F_a$$

When $P_{0r} < F_r$ use $P_{0r} = F_r$.

Bearing number	Snap ring groove dimensions			Snap ring dimensions		Installation-related dimensions							Mass ⁵⁾ kg												
	mm			mm		mm																			
Groove / Snap ring ³⁾ (See drawings)	D_1 Max.	a Max.	b Min.	r_o Max.	D_2 Max.	f Max.	d_a Min.	D_a Max. ⁴⁾	D_X (approx.)	C_Y Max.	C_Z Min.	r_{as} Max.	r_{Nas} Max.	(approx.)											
N					217.0	6.5	4.5	1	227.8	3.1	131	143	204	230	9.2	3.1	2	0.5	5.15						
NR															133	162	247	—	—	12.4					
N					161.8	3.3	1.9	0.6	171.5	1.7	136.5	139.5	158.5	173	4.7	1.7	1	0.5	0.8						
NR															138	144	172	188	5.1	1.7	1.5	0.5	1.52		
															136.5	—	193.5	—	—	—	—	1	—	2.31	
N					193.65	5.69	3.5	0.6	212.9	3.1	139	148	191	215	8.4	3.1	2	0.5	3.16						
NR															242	3.5	143	158	217	244	9.6	3.5	2.5	0.5	5.82
															146	—	264	—	—	—	—	3	—	15.3	
N					171.8	3.3	1.9	0.6	181.5	1.7	146.5	150	168.5	183	4.7	1.7	1	0.5	0.85						
NR															148	154	182	198	5.1	1.7	1.5	0.5	1.62		
															146.5	—	203.5	—	—	—	—	1	—	2.45	
															149	158	201	—	—	—	—	2	—	3.35	
N					242.0	6.5	4.5	1	262	3.5	153	173	237	264	9.6	3.5	2.5	0.5	7.57						
NR															156	—	284	—	—	—	—	3	—	18.5	
N					186.8	3.3	1.9	0.6	196.5	1.7	156.5	161	183.5	198	4.7	1.7	1	0.5	1.16						
NR															159	167	201	—	—	—	2	—	2.47		
															156.5	—	218.5	—	—	—	—	1	—	3.07	
															161	169	214	—	—	—	—	2	—	4.08	
															163	188	257	—	—	—	—	2.5	—	9.41	
															166	—	304	—	—	—	—	3	—	22	
N					196.8	3.3	1.9	0.6	206.5	1.7	166.5	171	193.5	208	4.7	1.7	1	0.5	1.23						
NR															169	178	211	—	—	—	2	—	2.61		
															168	—	232	—	—	—	—	1.5	—	3.64	
															171	183	229	—	—	—	—	2	—	5.05	
															173	—	277	—	—	—	—	2.5	—	11.7	
															176	—	324	—	—	—	—	3	—	26	
															176.5	182	208.5	—	—	—	—	1	—	1.63	
															179	188	221	—	—	—	—	2	—	2.74	
															178	—	252	—	—	—	—	1.5	—	4.93	
															181	196	249	—	—	—	—	2	—	6.76	
															186	—	294	—	—	—	—	3	—	14.5	
															186	—	344	—	—	—	—	3	—	30.7	

3) Sealed and shielded bearings are also available. 4) This dimension applies to sealed and shielded bearings. 5) Does not include bearings with snap rings. B-33

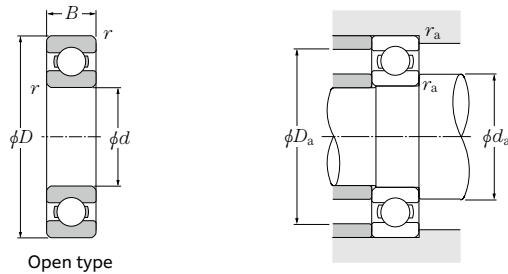

Open type

d 180 ~ 260mm

	Boundary dimensions			Basic load rating		Fatigue load limit kN C_u	Factor f_0	Allowable speed		Bearing number
	mm			dynamic kN C_r	static kN C_{0r}			Grease lubrication	Oil lubrication min ⁻¹	
d	D	B	$r_{s \min}^{1)}$							
180	225	22	1.1	67.0	73.0	3.40	16.1	2 600	3 000	6836
	250	33	2	122	119	5.45	16.5	2 400	2 900	6936
	280	31	2	129	134	5.85	16.5	2 300	2 700	16036
	280	46	2.1	210	199	9.70	15.6	2 300	2 700	6036
	320	52	4	252	241	11.9	15.1	1 900	2 200	6236
	380	75	4	390	405	19.0	13.9	1 700	2 000	6336
190	240	24	1.5	81.0	88.0	4.00	16.1	2 400	2 900	6838
	260	33	2	125	127	5.65	16.6	2 300	2 700	6938
	290	31	2	149	156	6.70	16.6	2 100	2 500	16038
	290	46	2.1	218	215	10.1	15.8	2 100	2 500	6038
	340	55	4	282	281	13.5	15.0	1 800	2 100	6238
	400	78	5	395	415	18.9	14.1	1 600	1 900	6338
200	250	24	1.5	82.0	91.5	4.05	16.1	2 300	2 700	6840
	280	38	2.1	174	168	7.45	16.2	2 200	2 600	6940
	310	34	2	157	160	6.65	16.6	2 000	2 400	16040
	310	51	2.1	241	243	11.2	15.6	2 000	2 400	6040
	360	58	4	298	310	14.4	15.2	1 700	2 000	6240
	420	80	5	455	500	22.3	13.8	1 500	1 800	6340
220	270	24	1.5	84.5	98.0	4.15	16.0	2 100	2 400	6844
	300	38	2.1	178	180	7.55	16.4	2 000	2 300	6944
	340	37	2.1	200	216	8.65	16.5	1 800	2 200	16044
	340	56	3	267	289	12.5	15.8	1 800	2 200	6044
	400	65	4	330	365	15.8	15.3	1 500	1 800	6244
	460	88	5	455	520	22.0	14.3	1 400	1 600	6344
240	300	28	2	94.0	112	4.55	15.9	1 900	2 200	6848
	320	38	2.1	188	203	8.05	16.5	1 800	2 100	6948
	360	37	2.1	197	217	8.30	16.5	1 700	2 000	16048
	360	56	3	276	310	12.8	16.0	1 700	2 000	6048
260	320	28	2	96.5	120	4.65	15.8	1 700	2 000	6852
	360	46	2.1	245	280	10.9	16.3	1 600	1 900	6952
	400	44	3	252	299	11.1	16.5	1 500	1 800	16052
	400	65	4	325	375	15.1	15.8	1 500	1 800	6052

1) Smallest allowable dimension for chamfer dimension r.

Dynamic equivalent radial load

$$P_r = X F_r + Y F_a$$

$\frac{f_0 \cdot F_a}{C_{0r}}$	e	$\frac{F_a}{F_r} \leq e$		$\frac{F_a}{F_r} > e$	
		X	Y	X	Y
0.172	0.19				2.30
0.345	0.22				1.99
0.689	0.26				1.71
1.03	0.28				1.55
1.38	0.30	1	0	0.56	1.45
2.07	0.34				1.31
3.45	0.38				1.15
5.17	0.42				1.04
6.89	0.44				1.00

Static equivalent radial load

$$P_{0r} = 0.6 F_r + 0.5 F_a$$

When $P_{0r} < F_r$, use $P_{0r} = F_r$.

Installation-related dimensions			Mass
d_a	mm	r_{as}	kg
Min.	Max.	Max.	(approx.)
186.5	218.5	1	2.03
189	241	2	4.76
189	271	2	6.49
191	269	2	8.8
196	304	3	15.1
196	364	3	35.6
198	232	1.5	2.62
199	251	2	4.98
199	281	2	6.77
201	279	2	9.18
206	324	3	18.2
210	380	4	41
208	242	1.5	2.73
211	269	2	7.1
209	301	2	8.68
211	299	2	11.9
216	344	3	21.6
220	400	4	46.3
228	262	1.5	3
231	289	2	7.69
231	329	2	11.3
233	327	2.5	15.7
236	384	3	30.2
240	440	4	60.8
249	291	2	4.6
251	309	2	8.28
251	349	2	12.1
253	347	2.5	16.8
269	311	2	5
271	349	2	13.9
273	387	2.5	18.5
276	384	3	25

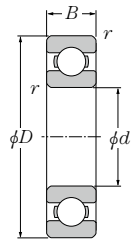

Open type

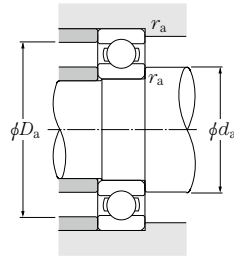

d 280 ~ 440mm

Boundary dimensions mm	Basic load rating			Factor	Allowable speed		Bearing number	
	dynamic kN	static kN	Fatigue load limit kN		min ⁻¹	Open type		
d D B r _{s min} ¹⁾	C _r	C _{0r}	C _u	f ₀	Grease lubrication	Oil lubrication		
280	350 33 2	151	177	6.65	16.1	1 600	1 900	6856
	380 46 2.1	252	299	11.1	16.5	1 500	1 800	6956
	420 44 3	257	315	11.3	16.5	1 400	1 600	16056
	420 65 4	360	420	16.9	15.5	1 400	1 600	6056
300	380 38 2.1	179	210	7.60	16.1	1 500	1 700	6860
	420 56 3	305	375	13.7	16.2	1 400	1 600	6960
	460 50 4	325	410	14.5	16.3	1 300	1 500	16060
	460 74 4	395	480	18.4	15.6	1 300	1 500	6060
320	400 38 2.1	186	228	7.95	16.1	1 400	1 600	6864
	440 56 3	315	405	14.1	16.4	1 300	1 500	6964
	480 50 4	335	440	14.9	16.4	1 200	1 400	16064
	480 74 4	410	530	19.3	15.7	1 200	1 400	6064
340	420 38 2.1	189	236	8.05	16.0	1 300	1 500	6868
	460 56 3	325	430	14.4	16.5	1 200	1 400	6968
	520 57 4	380	515	17.0	16.3	1 100	1 300	16068
	520 82 5	465	610	21.9	15.6	1 100	1 300	6068
360	440 38 2.1	207	258	8.55	16.0	1 200	1 400	6872
	480 56 3	330	455	14.8	16.5	1 100	1 300	6972
	540 57 4	390	550	17.6	16.4	1 100	1 200	16072
	540 82 5	485	670	23.0	15.7	1 100	1 200	6072
380	480 46 2.1	256	340	10.8	16.1	1 100	1 300	6876
	520 65 4	360	510	15.9	16.6	1 100	1 200	6976
	560 82 5	505	725	24.1	15.9	990	1 200	6076
400	500 46 2.1	251	340	10.6	16.0	1 100	1 200	6880
	540 65 4	370	535	16.4	16.5	990	1 200	6980
	600 90 5	565	825	26.9	15.7	930	1 100	6080
420	520 46 2.1	288	405	12.4	16.1	1 000	1 200	6884
	560 65 4	380	560	16.8	16.4	940	1 100	6984
	620 90 5	590	895	28.3	15.8	880	1 000	6084
440	540 46 2.1	292	420	12.6	16.0	950	1 100	6888
	600 74 4	405	615	18.0	16.4	890	1 000	6988

1) Smallest allowable dimension for chamfer dimension r.

Dynamic equivalent radial load
 $P_r = XF_r + YF_a$

$\frac{f_0 \cdot F_a}{C_{0r}}$	e	$\frac{F_a}{F_r} \leq e$		$\frac{F_a}{F_r} > e$	
		X	Y	X	Y
0.172	0.19				2.30
0.345	0.22				1.99
0.689	0.26				1.71
1.03	0.28				1.55
1.38	0.30	1	0	0.56	1.45
2.07	0.34				1.31
3.45	0.38				1.15
5.17	0.42				1.04
6.89	0.44				1.00

Static equivalent radial load
 $P_{0r} = 0.6F_r + 0.5F_a$

When $P_{0r} < F_r$, use $P_{0r} = F_r$.

Installation-related dimensions			Mass
d_a	mm	r_{as}	kg
Min.	Max.	Max.	(approx.)
289	341	2	7.4
291	369	2	14.8
293	407	2.5	23
296	404	3	31
311	369	2	10.5
313	407	2.5	23.5
316	444	3	32.5
316	444	3	43.8
331	389	2	10.9
333	427	2.5	24.8
336	464	3	34.2
336	464	3	46.1
351	409	2	11.5
353	447	2.5	26.2
356	504	3	47.1
360	500	4	61.8
371	429	2	12.3
373	467	2.5	27.5
376	524	3	49.3
380	520	4	64.7
391	469	2	19.7
396	504	3	39.8
400	540	4	67.5
411	489	2	20.6
416	524	3	41.6
420	580	4	87.6
431	509	2	21.6
436	544	3	43.4
440	600	4	91.1
451	529	2	22.5
456	584	3	60

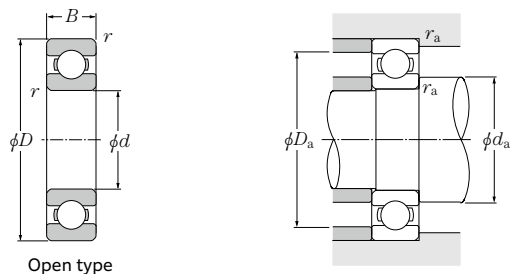

Open type

d 460 ~ 600mm

Boundary dimensions	Basic load rating			Factor	Allowable speed		Bearing number			
	mm				dynamic kN	static kN		Fatigue load limit kN	min ⁻¹	
d	D	B	r _{s min} ¹⁾	C _r	C _{0r}	C _u	f ₀	Grease lubrication	Oil lubrication	Open type
460	580	56	3	350	515	15.1	16.2	900	1 100	6892
	620	74	4	415	645	18.5	16.4	850	1 000	6992
480	600	56	3	355	540	15.4	16.1	860	1 000	6896
	650	78	5	480	770	21.5	16.5	810	950	6996
500	620	56	3	360	560	15.7	16.1	820	970	68/500
	670	78	5	490	805	22.2	16.5	770	910	69/500
530	650	56	3	365	580	15.9	16.0	770	900	68/530
560	680	56	3	370	600	16.1	16.0	710	840	68/560
600	730	60	3	415	705	18.2	16.0	660	780	68/600

1) Smallest allowable dimension for chamfer dimension r.

Dynamic equivalent radial load

$$P_r = XF_r + YF_a$$

$\frac{f_0 \cdot F_a}{C_{0r}}$	e	$\frac{F_a}{F_r} \leq e$		$\frac{F_a}{F_r} > e$	
		X	Y	X	Y
0.172	0.19				2.30
0.345	0.22				1.99
0.689	0.26				1.71
1.03	0.28	1	0	0.56	1.55
1.38	0.30				1.45
2.07	0.34				1.31
3.45	0.38				1.15
5.17	0.42				1.04
6.89	0.44				1.00

Static equivalent radial load

$$P_{0r} = 0.6F_r + 0.5F_a$$

When $P_{0r} < F_r$, use $P_{0r} = F_r$.

Installation-related dimensions			Mass
d _a	mm	r _{as}	kg
Min.	Max.	Max.	(approx.)
473	567	2.5	34.8
476	604	3	62.2
493	587	2.5	36.2
500	630	4	73
513	607	2.5	37.5
520	650	4	75.5
543	637	2.5	39.5
573	667	2.5	41.5
613	717	2.5	51.7

Expansion Compensating Bearings

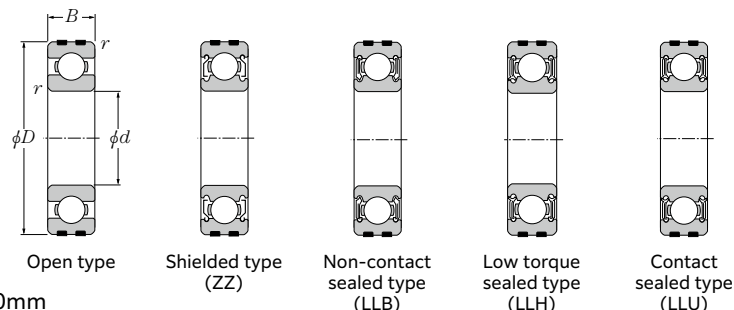

d 10 ~ 50mm

	Boundary dimensions			Basic load rating		Fatigue load limit	Allowable Factor load	f ₀	Allowable speed				Bearing number				
	mm			dynamic	static	kN	kN		Grease Open type, ZZ, LLB Z, LB	Oil Open type, Z, LB	LLH LH	LLU LU	Open type	Shielded or sealed type ²⁾ (See drawings)			
d	D	B	r _{s min} ¹⁾	C _r	C _{0r}	C _u	C _p										
10	26	8	0.3	5.05	1.96	0.138	1.65	12.4	29 000	34 000	25 000	21 000	EC-6000	ZZ	LLB	LLH	LLU
	30	9	0.6	5.65	2.39	0.182	2.39	13.2	25 000	30 000	21 000	18 000	EC-6200	ZZ	LLB	LLH	LLU
	35	11	0.6	9.10	3.50	0.273	3.45	11.4	23 000	27 000	20 000	16 000	EC-6300	ZZ	LLB	LLH	LLU
12	28	8	0.3	5.65	2.39	0.182	1.78	13.2	26 000	30 000	21 000	18 000	EC-6001JRX	ZZ	LLB	LLH	LLU
	32	10	0.6	6.75	2.75	0.214	2.29	12.7	22 000	26 000	20 000	16 000	EC-6201	ZZ	LLB	LLH	LLU
	37	12	1	10.8	4.20	0.325	3.65	11.1	20 000	24 000	19 000	15 000	EC-6301	ZZ	LLB	LLH	LLU
15	32	9	0.3	6.20	2.83	0.199	2.83	13.9	22 000	26 000	18 000	15 000	EC-6002	ZZ	LLB	LLH	LLU
	35	11	0.6	8.60	3.60	0.279	2.78	12.7	19 000	23 000	18 000	15 000	EC-6202	ZZ	LLB	LLH	LLU
	42	13	1	12.7	5.45	0.425	4.40	12.3	17 000	21 000	15 000	12 000	EC-6302	ZZ	LLB	LLH	LLU
17	35	10	0.3	7.55	3.35	0.263	2.88	13.6	20 000	24 000	16 000	14 000	EC-6003	ZZ	LLB	LLH	LLU
	40	12	0.6	10.6	4.60	0.243	3.45	12.8	18 000	21 000	15 000	12 000	EC-6203	ZZ	LLB	LLH	LLU
	47	14	1	15.0	6.55	0.355	6.55	12.2	16 000	19 000	14 000	11 000	EC-6303	ZZ	LLB	LLH	LLU
20	42	12	0.6	10.4	5.05	0.355	5.05	13.9	18 000	21 000	13 000	11 000	EC-6004	ZZ	LLB	LLH	LLU
	47	14	1	14.2	6.65	0.505	5.05	13.2	16 000	18 000	12 000	10 000	EC-6204	ZZ	LLB	LLH	LLU
	52	15	1.1	17.6	7.90	0.615	7.90	12.4	14 000	17 000	12 000	10 000	EC-6304	ZZ	LLB	LLH	LLU
25	47	12	0.6	11.2	5.85	0.380	5.85	14.5	15 000	18 000	11 000	9 400	EC-6005	ZZ	LLB	LLH	LLU
	52	15	1	15.5	7.85	0.550	6.55	13.9	13 000	15 000	11 000	8 900	EC-6205	ZZ	LLB	LLH	LLU
	62	17	1.1	23.5	10.9	0.855	10.9	12.6	12 000	14 000	9 700	8 100	EC-6305	ZZ	LLB	LLH	LLU
30	55	13	1	14.7	8.30	0.650	8.30	14.8	13 000	15 000	9 200	7 700	EC-6006	ZZ	LLB	LLH	LLU
	62	16	1	21.6	11.3	0.795	9.85	13.8	11 000	13 000	8 800	7 300	EC-6206	ZZ	LLB	LLH	LLU
	72	19	1.1	29.5	15.0	1.14	15.0	13.3	10 000	12 000	7 900	6 600	EC-6306	ZZ	LLB	LLH	LLU
35	62	14	1	17.7	10.3	0.805	10.3	14.8	12 000	14 000	8 200	6 800	EC-6007	ZZ	LLB	LLH	LLU
	72	17	1.1	28.4	15.3	1.09	14.5	13.8	9 800	11 000	7 600	6 300	EC-6207	ZZ	LLB	LLH	LLU
	80	21	1.5	37.0	19.1	1.47	18.5	13.1	8 800	10 000	7 300	6 000	EC-6307	ZZ	LLB	LLH	LLU
40	68	15	1	18.6	11.5	0.890	11.5	15.2	10 000	12 000	7 300	6 100	EC-6008	ZZ	LLB	LLH	LLU
	80	18	1.1	32.5	17.8	1.24	17.5	14.0	8 700	10 000	6 700	5 600	EC-6208	ZZ	LLB	LLH	LLU
	90	23	1.5	45.0	24.0	1.83	23.4	13.2	7 800	9 200	6 400	5 300	EC-6308	ZZ	LLB	LLH	LLU
45	75	16	1	23.2	15.1	1.16	15.1	15.3	9 200	11 000	6 500	5 400	EC-6009	ZZ	LLB	LLH	LLU
	85	19	1.1	36.0	20.4	1.60	20.3	14.1	7 800	9 200	6 200	5 200	EC-6209	ZZ	LLB	LLH	LLU
	100	25	1.5	58.5	32.0	2.50	27.4	13.1	7 000	8 200	5 600	4 700	EC-6309	ZZ	LLB	LLH	LLU
50	80	16	1	24.2	16.6	1.24	16.6	15.5	8 400	9 800	6 000	5 000	EC-6010	ZZ	LLB	LLH	LLU
	90	20	1.1	39.0	23.2	1.82	17.7	14.4	7 100	8 300	5 700	4 700	EC-6210	ZZ	LLB	LLH	LLU
	110	27	2	68.5	38.5	2.99	33.0	13.2	6 400	7 500	5 000	4 200	EC-6310	ZZ	LLB	LLH	LLU

1) Smallest allowable dimension for chamfer dimension r. 2) This bearing number is for double sealed and double shielded type bearings, but single sealed and single shielded type are also available. B-40

Expansion Compensating Bearings

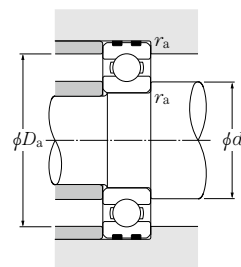

Dynamic equivalent radial load

$$P_r = X F_r + Y F_a$$

f ₀ ·F _a C _{0r}	e	F _a F _r ≤ e		F _a F _r > e	
		X	Y	X	Y
0.172	0.19				2.30
0.345	0.22				1.99
0.689	0.26				1.71
1.03	0.28				1.55
1.38	0.30	1	0	0.56	1.45
2.07	0.34				1.31
3.45	0.38				1.15
5.17	0.42				1.04
6.89	0.44				1.00

Static equivalent radial load

$$P_{0r} = 0.6 F_r + 0.5 F_a$$

When $P_{0r} < F_r$ use $P_{0r} = F_r$.

Installation-related dimensions			Mass	
mm			kg	
d _a	D _a	r _{as}	Open type (approx.)	
Min.	Max. ³⁾	Max.		

12	13.5	24	0.3	0.019
14	16	26	0.6	0.031
14	17	31	0.6	0.051

14	16	26	0.3	0.021
16	17.5	28	0.6	0.036
17	18.5	32	1	0.058

17	19	30	0.3	0.029
19	20.5	31	0.6	0.043
20	23	37	1	0.079

19	21	33	0.3	0.037
21	23	36	0.6	0.062
22	25	42	1	0.11

24	26	38	0.6	0.066
25	28	42	1	0.101
26.5	28.5	45.5	1	0.139

29	30.5	43	0.6	0.075
30	32	47	1	0.122
31.5	35	55.5	1	0.223

35	37	50	1	0.11
35	39	57	1	0.191
36.5	43	65.5	1	0.334

40	42	57	1	0.148
41.5	45	65.5	1	0.277
43	47	72	1.5	0.44

45	47	63	1	0.183
46.5	51	73.5	1	0.352
48	54	82	1.5	0.609

50	52.5	70	1	0.233
51.5	55.5	78.5	1	0.391
53	61.5	92	1.5	0.80

55	57.5	75	1	0.246
56.5	60	83.5	1	0.444
59	68.5	101	2	1.03

3) This dimension applies to sealed and shielded bearings.

AC Bearings

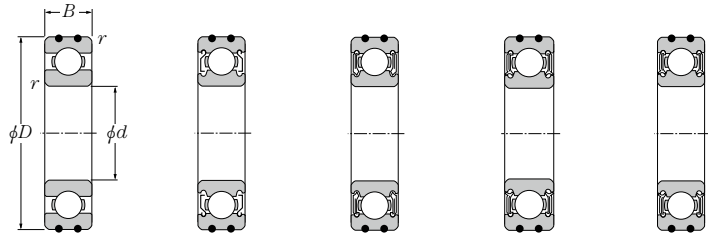

Open type Shielded type (ZZ) Non-contact sealed type (LLB) Low torque sealed type (LLH) Contact sealed type (LLU)

d 10 ~ 45mm

Boundary dimensions mm	Basic load rating		Fatigue load limit C _u kN	Allowable load C _p kN	Factor f ₀	Allowable speed min ⁻¹				Bearing number				
	d	D				B	r _{s,min} ¹⁾	C _r	C _{0r}	Grease Open type, ZZ, LLB Z, LB	Oil Open type, Z, LB LLH LLU	Open type	Shielded or sealed type ²⁾ (See drawings)	
10	26	8	0.3	5.05	1.96	0.138	1.53	12.4	29 000	34 000	25 000	21 000	AC-6000	ZZ LLB LLH LLU
	30	9	0.6	5.65	2.39	0.182	2.39	13.2	25 000	30 000	21 000	18 000	AC-6200	ZZ LLB LLH LLU
	35	11	0.6	9.10	3.50	0.273	2.98	11.4	23 000	27 000	20 000	16 000	AC-6300	ZZ LLB LLH LLU
12	28	8	0.3	5.65	2.39	0.182	1.73	13.2	26 000	30 000	21 000	18 000	AC-6001JRX	ZZ LLB LLH LLU
	32	10	0.6	6.75	2.75	0.214	2.75	12.7	22 000	26 000	20 000	16 000	AC-6201	ZZ LLB LLH LLU
	37	12	1	10.8	4.20	0.325	3.00	11.1	20 000	24 000	19 000	15 000	AC-6301	ZZ LLB LLH LLU
15	32	9	0.3	6.20	2.83	0.199	2.43	13.9	22 000	26 000	18 000	15 000	AC-6002	ZZ LLB LLH LLU
	35	11	0.6	8.60	3.60	0.279	2.71	12.7	19 000	23 000	18 000	15 000	AC-6202	ZZ LLB LLH LLU
	42	13	1	12.7	5.45	0.425	3.90	12.3	17 000	21 000	15 000	12 000	AC-6302	ZZ LLB LLH LLU
17	35	10	0.3	7.55	3.35	0.263	2.44	13.6	20 000	24 000	16 000	14 000	AC-6003	ZZ LLB LLH LLU
	40	12	0.6	10.6	4.60	0.243	3.50	12.8	18 000	21 000	15 000	12 000	AC-6203	ZZ LLB LLH LLU
	47	14	1	15.0	6.55	0.355	5.10	12.2	16 000	19 000	14 000	11 000	AC-6303	ZZ LLB LLH LLU
20	42	12	0.6	10.4	5.05	0.355	3.80	13.9	18 000	21 000	13 000	11 000	AC-6004	ZZ LLB LLH LLU
	47	14	1	14.2	6.65	0.505	4.20	13.2	16 000	18 000	12 000	10 000	AC-6204	ZZ LLB LLH LLU
	52	15	1.1	17.6	7.90	0.615	5.40	12.4	14 000	17 000	12 000	10 000	AC-6304	ZZ LLB LLH LLU
25	47	12	0.6	11.2	5.85	0.380	4.50	14.5	15 000	18 000	11 000	9 400	AC-6005	ZZ LLB LLH LLU
	52	15	1	15.5	7.85	0.550	5.80	13.9	13 000	15 000	11 000	8 900	AC-6205	ZZ LLB LLH LLU
	62	17	1.1	23.5	10.9	0.855	7.30	12.6	12 000	14 000	9 700	8 100	AC-6305	ZZ LLB LLH LLU
30	55	13	1	14.7	8.30	0.650	6.85	14.8	13 000	15 000	9 200	7 700	AC-6006	ZZ LLB LLH LLU
	62	16	1	21.6	11.3	0.795	7.55	13.8	11 000	13 000	8 800	7 300	AC-6206	ZZ LLB LLH LLU
	72	19	1.1	29.5	15.0	1.14	11.0	13.3	10 000	12 000	7 900	6 600	AC-6306	ZZ LLB LLH LLU
35	62	14	1	17.7	10.3	0.805	8.95	14.8	12 000	14 000	8 200	6 800	AC-6007	ZZ LLB LLH LLU
	72	17	1.1	28.4	15.3	1.09	9.65	13.8	9 800	11 000	7 600	6 300	AC-6207	ZZ LLB LLH LLU
	80	21	1.5	37.0	19.1	1.47	13.4	13.1	8 800	10 000	7 300	6 000	AC-6307	ZZ LLB LLH LLU
40	80	18	1.1	32.5	17.8	1.24	11.6	14.0	8 700	10 000	6 700	5 600	AC-6208	ZZ LLB LLH LLU
	90	23	1.5	45.0	24.0	1.83	16.6	13.2	7 800	9 200	6 400	5 300	AC-6308	ZZ LLB LLH LLU
45	85	19	1.1	36.0	20.4	1.60	14.7	14.1	7 800	9 200	6 200	5 200	AC-6209	ZZ LLB LLH LLU
	100	25	1.5	58.5	32.0	2.50	21.8	13.1	7 000	8 200	5 600	4 700	AC-6309	ZZ LLB LLH LLU

1) Smallest allowable dimension for chamfer dimension r. 2) This bearing number is for double sealed and double shielded type bearings, but single sealed and single shielded type are also available. B-42

AC Bearings

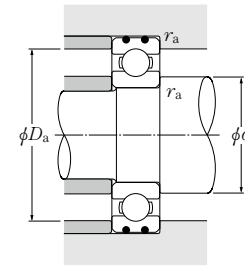

Dynamic equivalent radial load
 $P_r = XF_r + YF_a$

$\frac{f_0 \cdot F_a}{C_{0r}}$	e	$\frac{F_a}{F_r} \leq e$		$\frac{F_a}{F_r} > e$	
		X	Y	X	Y
0.172	0.19				2.30
0.345	0.22				1.99
0.689	0.26				1.71
1.03	0.28				1.55
1.38	0.30	1	0	0.56	1.45
2.07	0.34				1.31
3.45	0.38				1.15
5.17	0.42				1.04
6.89	0.44				1.00

Static equivalent radial load

$P_{0r} = 0.6F_r + 0.5F_a$
 When $P_{0r} < F_r$ use $P_{0r} = F_r$.

Installation-related dimensions mm				Mass kg
d _a Min.	D _a Max. ³⁾	r _a Max.	Open type (approx.)	
12	13.5	24	0.3	0.019
14	16	26	0.6	0.031
14	17	31	0.6	0.051
14	16	26	0.3	0.021
16	17.5	28	0.6	0.036
17	18.5	32	1	0.058
17	19	30	0.3	0.029
19	20.5	31	0.6	0.043
20	23	37	1	0.079
19	21	33	0.3	0.037
21	23	36	0.6	0.062
22	25	42	1	0.11
24	26	38	0.6	0.066
25	28	42	1	0.101
26.5	28.5	45.5	1	0.139
29	30.5	43	0.6	0.075
30	32	47	1	0.122
31.5	35	55.5	1	0.223
35	37	50	1	0.11
35	39	57	1	0.191
36.5	43	65.5	1	0.334
40	42	57	1	0.148
41.5	45	65.5	1	0.277
43	47	72	1.5	0.44
46.5	51	73.5	1	0.352
48	54	82	1.5	0.609
51.5	55.5	78.5	1	0.391
53	61.5	92	1.5	0.8

3) This dimension applies to sealed and shielded bearings.

Miniature and Small Size Ball Bearings

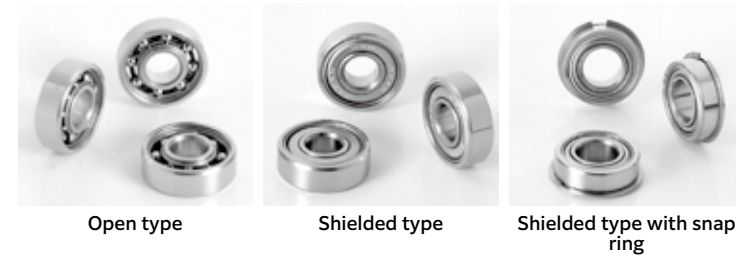
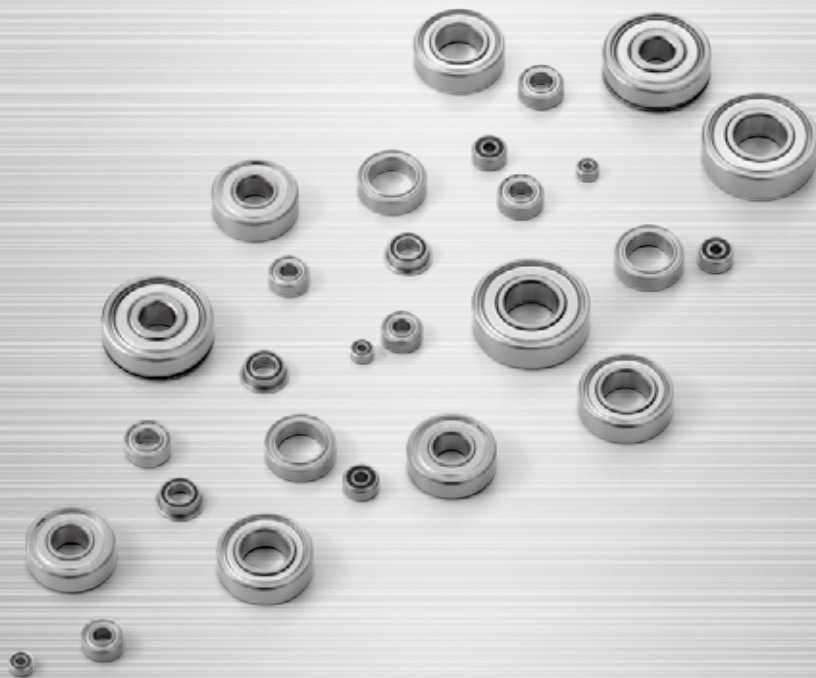

1. Design features and characteristics

The dimensional range of miniature and extra small bearings can be found in **Table 1**. Boundary dimensions for both metric and inch series are in accordance with the internationally specified ISO and ANSI/ABMA standards. The most widely used sealed and shielded type ball bearings generally have a 1 - 2 mm wider width dimension than open type bearings.

The main variations of these bearings are shown in **Table 2**. Miniature and extra small size ball bearings can also utilize snap rings, which simplify assembly within the housing. These bearings with snap rings can also be found in the dimensional tables in this catalog.

Among the most generally used sealed and shielded bearings are standard ZZ and ZZA type which incorporate non-contact steel shield plates. **Fig. 1** also shows non-contact type rubber sealed LLB and resin sealed SSA type bearings, as well as the contact-type rubber sealed LLU bearing.

Section "11. Lubrication" provides additional information on grease filled within the sealed and shielded bearings.

Table 1 Dimensional range

Bearing	Dimensional range
Miniature ball bearings	Nominal outer diameter $D < 9\text{mm}$
Extra small ball bearings	Nominal bore diameter $d < 10\text{mm}$ Nominal outer diameter $D \geq 9\text{mm}$

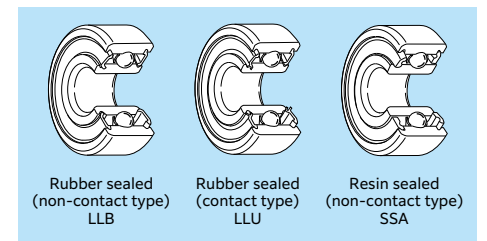

Fig. 1

Table 2 Main types and construction

Type	Standard type code			Flange-attached type code		
	Construction	Metric series	Inch series	Construction	Metric series	Inch series
Open type		6 BC	R		FL6 FLBC	FLR
Shielded type		6 X X ZZ W6 X X ZZ WBC X X X ZZ	RA X X ZZ		FL6 X X X ZZ FLW6 X X X ZZ FLWBC X X X ZZ	FLRA X X ZZ

Note: 1. Representative codes are shown. For further details, please refer to dimension tables.
2. May change to ZA or SA for shielded type bearings, according to the bearing number.

2. Standard cage type

Pressed steel cages are standard for miniature and small size bearings.



3. Dimensional and rotational accuracy

The accuracy of miniature and extra small ball bearings complies with JIS standards. Accuracy of these bearings is defined by Table A-54 in section "6. Bearing Accuracy." Flange accuracies are listed in Table 3.

Table 3 Tolerance and tolerance values for outer ring flange

Unit: μm

Accuracy class		Outer diameter dimensional tolerance Δ_{D1S} or Δ_{D2S}		Outer ring surface runout for rear surface S_{D1} Max.	Back face axial runout S_{ea1} Max.	Width deviation Δ_{c15} or Δ_{c25}		Width unevenness V_{c15} or V_{c25} Max.			
		Upper	Lower			Upper	Lower				
ISO standard	Class 0	* (see table below)		—	—	Identical to same bearing's inner ring Δ_{BS} .		Identical to same bearing's inner ring V_{BS} .			
	Class 6										
	Class 5								8	11	5
	Class 4								4	7	2.5
	Class 2								1.5	3 ¹⁾ 4	1.5

1) Applies to nominal outer diameter D of 18 mm or less.

* Unit: μm

Flange nominal outer diameter D_1 or D_2 mm		Outer diameter dimensional tolerance Δ_{D1S} or Δ_{D2S}	
Over	Incl.	Upper	Lower
—	10	+220	-36
10	18	+270	-43
18	30	+330	-52
30	50	+390	-62

4. Radial internal clearance

Radial internal clearance is defined by Table A-88 in section "8. Internal Clearance and Preload."

The radial clearance values for high precision miniature and extra small bearings can be found in Table 4.

Table 4 Radial internal clearance for high precision bearings

Unit: μm

MIL Standard Code	Tight				Standard				Loose		Extra Loose			
	C2S		CNS		CNM		CNL		C3S		C3M		C3L	
Internal clearance	Min.	Max.	Min.	Max.	Min.	Max.	Min.	Max.	Min.	Max.	Min.	Max.	Min.	Max.
	0	5	3	8	5	10	8	13	10	15	13	20	20	28

Note: 1. These standards are specified in accordance with MIL B23063. However, **NTN** codes are shown.

2. Clearance values do not include compensation for measuring load.

Miniature and Small Size Ball Bearings



Metric series

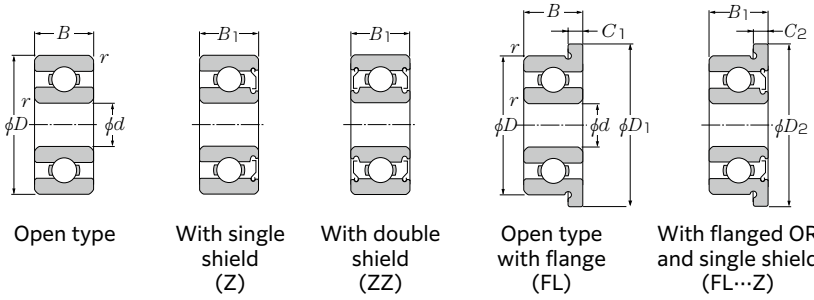

d 1.5 ~ 5mm

d	Boundary dimensions								Basic load rating		Fatigue load limit N C _u	Factor f ₀	Allowable speed min ⁻¹		
	mm								dynamic N C _r	static N C _{0r}			Grease lubrication	Oil lubrication	
	D	B	B ₁	D ₁	D ₂	C ₁	C ₂	r _{s min} ¹⁾							
1.5	4	1.2	2	5	5	0.4	0.6	0.15	113	29.0	0.775	13.6	88 000	100 000	
	5	2	2.6	6.5	6.5	0.6	0.8	0.15	189	51.0	1.35	13.3	79 000	93 000	
	6	2.5	3	7.5	7.5	0.6	0.8	0.15	305	86.0	2.28	12.3	71 000	84 000	
2	4	1.2	—	—	—	—	—	0.05	115	37.0	0.970	14.8	83 000	98 000	
	5	1.5	2.3	6.1	6.1	0.5	0.6	0.08	189	51.0	1.35	13.3	74 000	87 000	
	5	2	2.5	—	—	—	—	0.1	189	51.0	1.35	13.3	74 000	87 000	
	6	2.3	3	7.5	7.5	0.6	0.8	0.15	310	89.0	2.37	12.8	67 000	79 000	
	6	2.5	—	7.2	—	0.6	—	0.15	310	89.0	2.37	12.8	67 000	79 000	
	7	2.5	—	—	—	—	—	0.15	430	120	3.20	11.9	59 000	70 000	
	7	2.8	3.5	8.5	8.5	0.7	0.9	0.15	425	125	3.30	12.4	62 000	73 000	
2.5	5	1.5	2.3	—	—	—	—	0.08	169	59.0	1.56	15.0	70 000	82 000	
	6	1.8	2.6	7.1	7.1	0.5	0.8	0.08	231	73.0	1.92	14.2	65 000	76 000	
	7	—	3	—	8.2	—	—	0.6	0.15	315	96.0	2.53	13.7	59 000	70 000
	7	2.5	3.5	8.5	8.5	0.7	0.9	0.15	315	96.0	2.53	13.7	59 000	70 000	
	8	2.5	2.8	9.2	—	0.6	—	0.15	475	152	4.05	13.2	56 000	66 000	
	8	2.8	4	9.5	9.5	0.7	0.9	0.15	610	174	7.05	11.5	56 000	66 000	
3	6	2	2.5	7.2	7.2	0.6	0.6	0.08	268	94.0	2.47	14.7	60 000	71 000	
	7	2	3	8.1	8.1	0.5	0.8	0.1	430	130	3.45	12.9	58 000	68 000	
	8	2.5	—	9.2	—	0.6	—	0.15	620	180	7.25	11.9	54 000	63 000	
	8	3	4	9.5	9.5	0.7	0.9	0.15	620	180	7.25	11.9	54 000	63 000	
	9	2.5	4	10.2	10.6	0.6	0.8	0.15	700	219	8.85	12.4	50 000	59 000	
	9	3	5	10.5	10.5	0.7	1	0.15	700	219	8.85	12.4	50 000	59 000	
	10	4	4	11.5	11.5	1	1	0.15	710	224	9.05	12.7	50 000	58 000	
	4	7	2	2.5	8.2	8.2	0.6	0.6	0.08	246	88.0	2.31	15.3	54 000	63 000
		8	2	3	9.2	9.2	0.6	0.6	0.08	440	140	5.65	13.9	52 000	61 000
		9	2.5	4	10.3	10.3	0.6	1	0.15	710	224	9.05	12.7	49 000	57 000
10		3	4	11.2	11.6	0.6	0.8	0.15	720	235	9.50	13.3	46 000	55 000	
11		4	4	12.5	12.5	1	1	0.15	790	276	11.1	13.7	45 000	52 000	
12		4	4	13.5	13.5	1	1	0.2	1 080	360	14.4	12.8	43 000	51 000	
13		5	5	15	15	1	1	0.2	1 450	490	19.8	12.4	42 000	49 000	
16		5	5	—	—	—	—	0.3	1 940	680	23.1	12.4	37 000	44 000	
5	8	2	2.5	9.2	9.2	0.6	0.6	0.08	241	91.0	2.39	15.8	49 000	57 000	
	9	2.5	3	10.2	10.2	0.6	0.6	0.15	555	211	5.55	14.6	46 000	55 000	
	10	3	4	11.2	11.6	0.6	0.8	0.15	790	276	11.1	13.7	45 000	52 000	

1) Smallest allowable dimension for chamfer dimension r.

Miniature and Small Size Ball Bearings

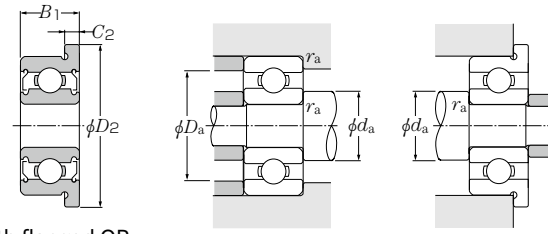

With flanged OR and double shield (FL...ZZ)

Dynamic equivalent radial load
 $P_r = X F_r + Y F_a$

$f_0 \cdot F_a / C_{0r}$	e	$F_a / F_r \leq e$		$F_a / F_r > e$	
		X	Y	X	Y
0.172	0.19	1	0	0.56	2.30
0.345	0.22				1.99
0.689	0.26				1.71
1.03	0.28				1.55
1.38	0.30				1.45
2.07	0.34				1.31
3.45	0.38				1.15
5.17	0.42				1.04
6.89	0.44				1.00

Static equivalent radial load
 $P_{0r} = 0.6 F_r + 0.5 F_a$

When $P_{0r} < F_r$ use $P_{0r} = F_r$.

Open type	Bearing numbers						Installation-related dimensions mm				Mass (approx.) g	
	With single shield	With double shield	Open type with flange	With flanged OR and single shield	With flanged OR and double shield	d _a Min.	D _a Max. ²⁾	r _{as} Max.	Open type	Open type with flange		
68/1.5	W68/1.5SA	SSA	FL68/1.5	FLW68/1.5SA	SSA	2.3	2.4	3.2	0.05	0.07	0.09	
	W69/1.5ASA	SSA	FL69/1.5A	FLW69/1.5ASA	SSA	2.7	2.9	3.8	0.15	0.18	0.24	
	W60/1.5ZA	ZZA	FL60/1.5	FLW60/1.5ZA	ZZA	2.7	3	4.8	0.15	0.35	0.42	
672	—	—	—	—	—	2.5	2.6	3.5	0.05	0.06	—	
682	W682SA	SSA	FL682	FLW682SA	SSA	2.8	2.9	4.2	0.08	0.13	0.17	
BC2-5	WBC2-5SA	SSA	—	—	—	2.8	2.9	4.2	0.1	0.16	—	
692	W692SA	SSA	FL692	FLW692SA	SSA	3.2	3.3	4.8	0.15	0.31	0.38	
BC2-6	—	—	FLBC2-6	—	—	3.2	3.3	4.8	0.15	0.32	0.38	
BC2-7A	—	—	—	—	—	3.2	3.6	5.8	0.15	0.44	—	
602	W602ZA	ZZA	FL602	FLW602ZA	ZZA	3.2	3.7	5.8	0.15	0.54	0.64	
67/2.5	W67/2.5ZA	ZZA	—	—	—	3.1	3.3	4.4	0.08	0.11	—	
68/2.5	W68/2.5ZA	ZZA	FL68/2.5	FLW68/2.5ZA	ZZA	3.1	3.6	4.8	0.08	0.22	0.26	
—	WBC2.5-7ZA	ZZA	—	FLWBC2.5-7ZA	ZZA	3.7	4	5.8	0.15	0.6 ³⁾	0.67 ³⁾	
69/2.5	W69/2.5SA	SSA	FL69/2.5	FLW69/2.5SA	SSA	3.7	4	5.8	0.15	0.43	0.53	
BC2-5-8	WBC2.5-8ZA	ZZA	FLBC2.5-8	—	—	3.7	4.3	6.8	0.15	0.57	0.65	
60/2.5	W60/2.5ZA	ZZA	FL60/2.5	FLW60/2.5ZA	ZZA	3.7	4.1	6.8	0.15	0.72	0.83	
673	WA673SA	SSA	FL673	FLWA673SA	SSA	3.6	4.1	5.4	0.08	0.2	0.26	
683	W683Z	ZZ	FL683	FLW683Z	ZZ	3.9	4.1	5.8	0.1	0.33	0.38	
BC3-8	—	—	FLBC3-8	—	—	4.2	4.4	6.8	0.15	0.52	0.6	
693	W693Z	ZZ	FL693	FLW693Z	ZZ	4.2	4.4	6.8	0.15	0.61	0.72	
BC3-9	WBC3-9ZA	ZZA	FLBC3-9	FLAWBC3-9ZA	ZZA	4.2	5	7.8	0.15	0.71	0.79	
603	W603Z	ZZ	FL603	FLW603Z	ZZ	4.2	5	7.8	0.15	0.92	1	
623	623Z	ZZ	FL623	FL623Z	ZZ	4.2	5.2	8.8	0.15	1.6	1.8	
674A	WA674ASA	SSA	FL674A	FLWA674ASA	SSA	4.6	5	6.4	0.08	0.28	0.35	
BC4-8	WBC4-8Z	ZZ	FLBC4-8	FLWBC4-8Z	ZZ	4.8	5	6.8	0.08	0.38	0.46	
684AX50	W684AX50Z	ZZ	FL684AX50	FLW684AX50Z	ZZ	5	5.2	7.8	0.1	0.67	0.76	
BC4-10	WBC4-10Z	ZZ	FLBC4-10	FLAWBC4-10Z	ZZ	5.2	6	8.8	0.15	1	1.1	
694	694Z	ZZ	FL694	FL694Z	ZZ	5.2	6.4	9.8	0.15	1.8	2	
604	604Z	ZZ	FL604	FL604Z	ZZ	5.6	6.6	10.4	0.2	2.1	2.3	
624	624Z	ZZ	FL624	FL624Z	ZZ	5.6	6.2	11.4	0.2	3.2	3.5	
634	634Z	ZZ	—	—	—	6	7.6	14	0.3	5.1	—	
675	WA675Z	ZZ	FL675	FLWA675Z	ZZ	5.6	6	7.4	0.08	0.32	0.4	
BC5-9	WBC5-9Z	ZZ	FLBC5-9	FLWBC5-9Z	ZZ	5.2	6.1	7.8	0.15	0.55	0.63	
BC5-10	WBC5-10Z	ZZ	FLBC5-10	FLWBC5-10Z	ZZ	6.2	6.4	8.8	0.15	0.88	0.97	

2) This dimension applies to sealed and shielded bearings. 3) Values for double shielded bearings are shown.

Miniature and Small Size Ball Bearings

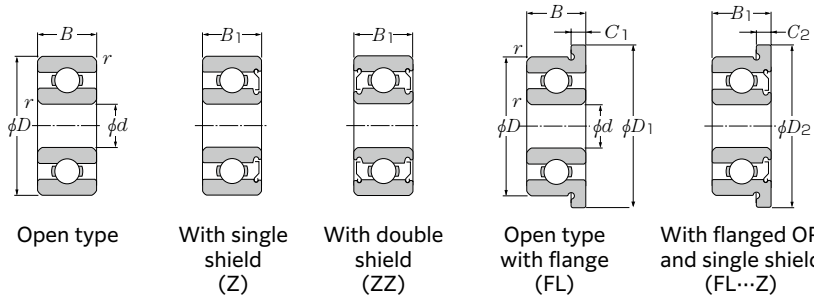

d 5 ~ 9mm

d	Boundary dimensions								Basic load rating		Fatigue Factor	Allowable speed		
	mm								dynamic	static	limit	Grease	Oil	
	D	B	B ₁	D ₁	D ₂	C ₁	C ₂	r _{s min} ¹⁾	C _r	C _{0r}	N	f ₀	lubrication	lubrication
5	11	—	4	—	12.6	—	0.8	0.15	795	282	11.4	14.0	43 000	51 000
	11	3	5	12.5	12.5	0.8	1	0.15	795	282	11.4	14.0	43 000	51 000
	13	4	4	15	15	1	0.2	1 190	430	17.3	13.4	40 000	47 000	
	13	—	5	—	15	—	1	0.2	1 190	430	17.3	13.4	40 000	47 000
	14	5	5	16	16	1	1	0.2	1 470	505	20.5	12.8	39 000	46 000
	16	5	5	18	18	1	1	0.3	1 940	680	23.1	12.4	37 000	44 000
	19	6	6	—	—	—	—	0.3	2 590	885	64.5	12.1	34 000	40 000
6	10	2.5	3	11.2	11.2	0.6	0.6	0.1	515	196	5.15	15.2	43 000	51 000
	12	3	4	13.2	13.6	0.6	0.8	0.15	920	365	14.8	14.5	40 000	47 000
	13	3.5	5	15	15	1.0	1.1	0.15	1 200	440	17.5	13.7	39 000	46 000
	15	5	5	17	17	1.2	1.2	0.2	1 490	530	21.3	13.3	37 000	44 000
	16	6	6	—	—	—	—	0.2	1 960	695	28.1	12.7	36 000	42 000
	17	6	6	19	19	1.2	1.2	0.3	2 430	865	35.0	12.3	35 000	42 000
	19	6	6	22	22	1.5	1.5	0.3	2 590	885	64.5	12.1	34 000	40 000
7	11	2.5	3	12.2	12.2	0.6	0.6	0.1	610	269	7.05	15.6	40 000	47 000
	13	3	4	14.2	14.6	0.6	0.8	0.15	915	375	15.2	14.9	38 000	45 000
	14	3.5	5	16	16	1	1.1	0.15	1 300	505	20.4	14.0	37 000	44 000
	17	5	5	19	19	1.2	1.2	0.3	1 780	715	28.8	14.0	35 000	41 000
	19	6	6	—	—	—	—	0.3	2 480	910	60.0	12.9	34 000	40 000
	22	7	7	—	—	—	—	0.3	3 700	1 400	97.0	12.5	32 000	37 000
8	12	2.5	3.5	13.2	13.6	0.6	0.8	0.1	570	252	6.60	15.9	38 000	45 000
	14	3.5	4	15.6	15.6	0.8	0.8	0.15	910	385	15.5	15.2	36 000	43 000
	16	4	5	18	18	1	1.1	0.2	1 780	715	28.8	14.0	35 000	41 000
	19	6	6	22	22	1.5	1.5	0.3	2 200	865	35.0	13.8	33 000	39 000
	22	7	7	25	25	1.5	1.5	0.3	3 700	1 400	97.0	12.5	32 000	37 000
	24	8	8	—	—	—	—	0.3	4 450	1 590	122	11.7	31 000	36 000
9	14	3	4.5	—	—	—	—	0.1	1 020	465	18.8	15.5	36 000	42 000
	17	4	5	19	19	1	1.1	0.2	1 910	820	33.0	14.4	33 000	39 000
	20	6	6	—	—	—	—	0.3	2 750	1 090	44.0	13.5	32 000	38 000
	24	7	7	—	—	—	—	0.3	3 750	1 450	94.5	12.9	31 000	36 000
	26	8	8	—	—	—	—	0.6	5 050	1 960	138	12.4	30 000	35 000

1) Smallest allowable dimension for chamfer dimension r.

Miniature and Small Size Ball Bearings

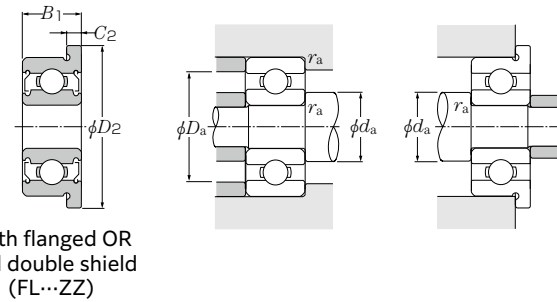

With flanged OR and double shield (FL...ZZ)

Dynamic equivalent radial load

$$P_r = X F_r + Y F_a$$

$\frac{f_0 \cdot F_a}{C_{0r}}$	e	$\frac{F_a}{F_r} \leq e$		$\frac{F_a}{F_r} > e$	
		X	Y	X	Y
0.172	0.19				2.30
0.345	0.22				1.99
0.689	0.26				1.71
1.03	0.28				1.55
1.38	0.30				1.45
2.07	0.34				1.31
3.45	0.38				1.15
5.17	0.42				1.04
6.89	0.44				1.00

Static equivalent radial load

$$P_{0r} = 0.6 F_r + 0.5 F_a$$

When $P_{0r} < F_r$ use $P_{0r} = F_r$.

Open type	With single shield	Bearing numbers		With flanged OR and single shield	With flanged OR and double shield	Installation-related dimensions mm			Mass (approx.) g	
		With double shield	Open type with flange			d_a Min.	D_a Max. ²⁾	r_{as} Max.	Open type	Open type with flange
—	WBC5-11Z	ZZ	—	FLWBC5-11Z	ZZ	6.2	6.8 9.8	0.2	1.8 ³⁾	2 ³⁾
685	W685Z	ZZ	FL685	FLW685Z	ZZ	6.2	6.8 9.8	0.15	1.1	1.3
695A	695AZ	ZZ	FL695A	FL695AZ	ZZ	6.6	6.9 11.4	0.2	2.4	2.7
—	WBC5-13Z	ZZ	—	FLWBC5-13Z	ZZ	6.6	6.9 11.4	0.2	3.4 ³⁾	3.7 ³⁾
605	605Z	ZZ	FL605	FL605Z	ZZ	6.6	7.4 12.4	0.2	3.5	3.9
625	625Z	ZZ	FL625	FL625Z	ZZ	7	7.6 14	0.3	4.8	5.2
635	635Z	ZZ	—	—	—	7	9.5 17	0.3	8	—
676A	WA676AZ	ZZ	FL676A	FLWA676AZ	ZZ	6.6	6.7 9.2	0.1	0.65	0.74
BC6-12	WBC6-12Z	ZZ	FLBC6-12	FLAWBC6-12Z	ZZ	7.2	7.9 10.8	0.15	1.3	1.4
686	W686Z	ZZ	FL686	FLW686Z	ZZ	7	7.2 11.8	0.15	1.9	2.2
696	696Z	ZZ	FL696	FL696Z	ZZ	7.6	7.8 13.4	0.2	3.8	4.3
BC6-16A	BC6-16AZ	ZZ	—	—	—	7.6	8 14.4	0.2	5.2	—
606	606Z	ZZ	FL606	FL606Z	ZZ	8	8.6 15	0.3	6	6.5
626	626Z	ZZ	FL626	FL626Z	ZZ	8	9.5 17	0.3	8.1	9.2
677	WA677Z	ZZ	FL677	FLWA677Z	ZZ	7.8	8.1 10.2	0.1	0.67	0.77
BC7-13	WBC7-13Z	ZZ	FLBC7-13	FLAWBC7-13Z	ZZ	8.2	8.9 11.8	0.15	1.4	1.5
687A	W687AZ	ZZ	FL687A	FLW687AZ	ZZ	8.2	8.7 12.8	0.15	2.1	2.4
697	697Z	ZZ	FL697	FL697Z	ZZ	9	10 15	0.3	5.2	5.7
607	607Z	ZZ	—	—	—	9	10.4 17	0.3	8	—
627	627Z	ZZ	—	—	—	9	12.2 20	0.3	13	—
678A	W678AZ	ZZ	FL678A	FLAW678AZ	ZZ	8.8	9.1 11.2	0.1	0.75	0.86
BC8-14	WBC8-14Z	ZZ	FLBC8-14	FLWBC8-14Z	ZZ	9.2	9.5 12.8	0.15	1.8	1.9
688A	W688AZ	ZZ	FL688A	FLW688AZ	ZZ	9.6	10 14.4	0.2	3.1	3.5
698	698Z	ZZ	FL698	FL698Z	ZZ	10	10.6 17	0.3	7.3	8.4
608	608Z	ZZ	FL608	FL608Z	ZZ	10	12.2 20	0.3	12	13
628	628Z	ZZ	—	—	—	10	12.1 22	0.3	17	—
679	W679Z	ZZ	—	—	—	9.8	10.4 13.2	0.1	1.4	—
689	W689Z	ZZ	FL689	FLW689Z	ZZ	10.6	10.7 15.4	0.2	3.2	3.6
699	699Z	ZZ	—	—	—	11	11.6 18	0.3	8.2	—
609JX2	609JX2Z	ZZ	—	—	—	11	13.1 22	0.3	14	—
629X50	629X50Z	ZZ	—	—	—	13	13.9 22	0.3	20	—

2) This dimension applies to sealed and shielded bearings. 3) Values for double shielded bearings are shown.

Miniature and Small Size Ball Bearings



Inch series

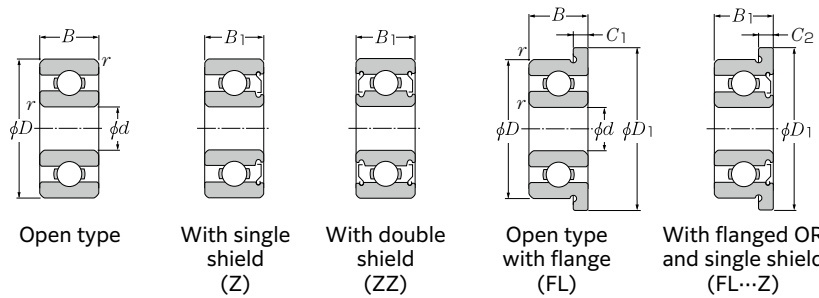

d 1.984 ~ 9.525mm

d	Boundary dimensions							Basic load rating		Factor f_0	Allowable speed min^{-1}	Oil lubrication	
	mm							dynamic	static			Grease lubrication	Oil lubrication
	D	B	B ₁	D ₁	C ₁	C ₂	$r_{s \text{ min}}^{1)}$	C _r	C _{0r}				
1.984	6.35	2.38	3.571	7.52	0.58	0.79	0.08	310	89.0	2.37	12.8	67 000	79 000
2.380	4.762	1.588	2.38	5.94	0.46	0.79	0.08	137	42.0	1.12	14.8	73 000	85 000
	7.938	2.779	3.571	9.12	0.58	0.79	0.13	475	152	4.05	13.2	56 000	66 000
3.175	6.35	2.38	2.779	7.52	0.58	0.79	0.08	315	96.0	2.53	13.7	59 000	70 000
	7.938	2.779	3.571	9.12	0.58	0.79	0.08	620	180	7.25	11.9	54 000	63 000
	9.525	2.779	3.571	10.72	0.58	0.79	0.13	710	224	9.05	12.7	49 000	58 000
	9.525	3.967	3.967	11.18	0.76	0.76	0.3	710	224	9.05	12.7	49 000	58 000
3.967	12.7	4.366	4.366	—	—	—	0.3	1 270	395	16.1	11.7	43 000	51 000
	7.938	2.779	3.175	9.12	0.58	0.91	0.08	370	133	3.50	14.8	51 000	60 000
4.762	7.938	2.779	3.175	9.12	0.58	0.91	0.08	440	143	3.80	14.2	49 000	58 000
	9.525	3.175	3.175	10.72	0.58	0.79	0.08	785	268	10.8	13.3	46 000	55 000
	12.7	3.967	—	—	—	—	0.3	1 450	490	19.8	12.4	41 000	48 000
	12.7	4.978	4.978	14.35	1.07	1.07	0.3	1 450	490	19.8	12.4	41 000	48 000
6.350	9.525	3.175	3.175	10.72	0.58	0.91	0.08	232	94.0	2.47	16.4	43 000	51 000
	12.7	3.175	4.762	13.89	0.58	1.14	0.13	920	370	15.0	14.7	39 000	46 000
	15.875	4.978	4.978	17.53	1.07	1.07	0.3	1 640	615	24.9	13.6	36 000	43 000
	19.05	—	7.142	—	—	—	0.41	2 590	885	64.5	12.1	34 000	40 000
9.525	22.225	—	7.142	24.61	—	1.57	0.41	3700	1 400	94.5	12.7	31 000	37 000

1) Smallest allowable dimension for chamfer dimension r.

Miniature and Small Size Ball Bearings

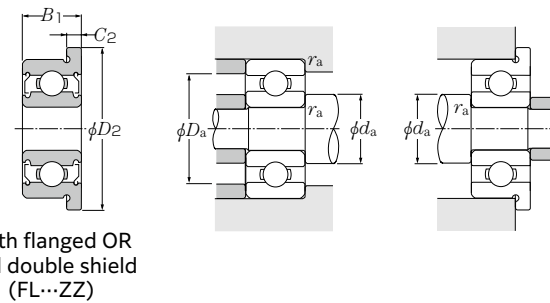

With flanged OR and double shield (FL...ZZ)

Dynamic equivalent radial load
 $P_r = X F_r + Y F_a$

$\frac{f_0 \cdot F_a}{C_{0r}}$	e	$\frac{F_a}{F_r} \leq e$		$\frac{F_a}{F_r} > e$	
		X	Y	X	Y
0.172	0.19	1	0	0.56	2.30
0.345	0.22				1.99
0.689	0.26				1.71
1.03	0.28				1.55
1.38	0.30				1.45
2.07	0.34				1.31
3.45	0.38				1.15
5.17	0.42				1.04
6.89	0.44				1.00

Static equivalent radial load

$P_{0r} = 0.6 F_r + 0.5 F_a$
When $P_{0r} < F_r$ use $P_{0r} = F_r$.

Open type	Bearing numbers					Installation-related dimensions				Mass (approx.)	
	With single shield	With double shield	Open type with flange	With flanged OR and single shield	With flanged OR and double shield	Min. d_a	Max. $d_a^{2)}$	Max. D_a	Max. r_{as}	Open type	Open type with flange
R1-4	RA1-4ZA	ZZA	FLR1-4	FLRA1-4ZA	ZZA	2.8	3.3	5.5	0.08	0.35	0.41
R133	RA133ZA	ZZA	FLR133	FLRA133ZA	ZZA	2.9	3.1	4	0.08	0.12	0.16
	R1-5	RA1-5ZA	ZZA	FLR1-5	FLRA1-5ZA	ZZA	3.2	4.3	7.1	0.1	0.69
R144	RA144ZA	ZZA	FLR144	FLRA144ZA	ZZA	3.9	4	5.5	0.08	0.27	0.33
R2-5	RA2-5Z	ZZ	FLR2-5	FLRA2-5Z	ZZ	4	4.4	7	0.08	0.61	0.68
RA2-6	RA2-6ZA	ZZA	FLR2-6	FLRA2-6ZA	ZZA	4	5.2	8.7	0.1	0.88	0.96
R2	RA2ZA	ZZA	FLR2	FLRA2ZA	ZZA	4.8	5.2	7.8	0.3	1.3	1.5
RA2	RA2Z	ZZ	—	—	—	4.8	5.4	11	0.3	2.5	—
RA155	RA155ZA	ZZA	FLR155	FLRA155ZA	ZZA	4.8	5.3	7	0.08	0.54	0.61
R156	RA156Z	ZZ	FLR156	FLRA156Z	ZZ	5.5	5.6	7	0.08	0.44	0.51
R166	R166Z	ZZ	FLR166	FLAR166Z	ZZ	5.6	5.9	8.7	0.08	0.8	0.89
R3	—	—	—	—	—	6.4	7.2	11	0.3	2.2	—
RA3	RA3Z	ZZ	FLRA3	FLRA3Z	ZZ	6	6.4	11	0.3	2.4	2.7
R168A	R168AZ	AZZ	—	FLAR168AZ	ZZ	7.1	7.3	8.7	0.08	0.6	0.69
R188	RA188ZA	ZZA	FLR188	FLRA188ZA	ZZA	7.2	8.2	11.8	0.1	1.6	1.7
R4	R4Z	ZZ	FLR4	FLR4Z	ZZ	8	8.6	14.2	0.3	4.4	4.8
—	RA4Z	ZZ	—	—	—	8.4	9.5	17	0.4	11 ³⁾	—
—	R6Z	ZZ	—	FLR6Z	ZZ	11.5	11.9	20.2	0.4	14 ³⁾	15 ³⁾

2) This dimension applies to sealed and shielded bearings. 3) Values for double shielded bearings are shown.

● Miniature and Small Size Ball Bearings



With snap ring groove
With snap ring

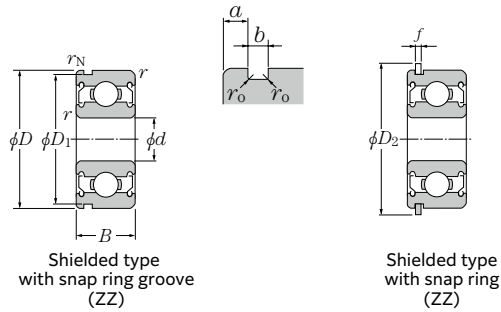

d 5 ~ 10mm

	Boundary dimensions				Basic load rating		Fatigue load limit N C _u	Factor f ₀	Allowable speed		Bearing numbers ²⁾	
	mm	mm	mm	mm	dynamic	static			min ⁻¹	Oil lubrication	Shielded type with snap ring groove	Shielded type with snap ring
d	D	B	r _{s min} ¹⁾	r _{Na} Min.	C _r	C _{0r}		Grease lubrication				
5	13	4	0.2	0.1	1 190	430	17.3	13.4	40 000	47 000	SC559ZZN	ZZNR
	14	5	0.2	0.2	1 470	505	20.5	12.8	39 000	46 000	SC571ZZN	ZZNR
6	12	4	0.15	0.1	640	365	—	14.5	40 000	47 000	*F-SC6A06ZZ1N	ZZ1NR
	13	5	0.15	0.1	1 200	440	17.5	13.7	39 000	46 000	SC6A04ZZN	ZZNR
	15	5	0.2	0.2	1 490	530	21.3	13.3	37 000	44 000	SC6A17ZZN	ZZNR
	19	6	0.3	0.3	2 590	885	64.5	12.1	34 000	40 000	SC669ZZN	ZZNR
8	16	5	0.2	0.1	1 390	585	23.6	14.6	35 000	41 000	SC890ZZN	ZZNR
	22	7	0.3	0.4	3 700	1 400	97.0	12.5	32 000	37 000	SC850ZZN	ZZNR
10	26	8	0.3	0.3	5 050	1 960	138	12.4	29 000	34 000	SC0039ZZN	ZZNR

1) Smallest allowable dimension for chamfer dimension r.
2) "*" mark indicates that stainless steel is used.

● Miniature and Small Size Ball Bearings

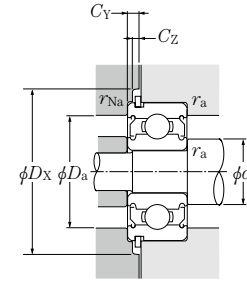

Dynamic equivalent radial load
 $P_r = X F_r + Y F_a$

$\frac{f_0 \cdot F_a}{C_{0r}}$	e	$\frac{F_a}{F_r} \leq e$		$\frac{F_a}{F_r} > e$	
		X	Y	X	Y
0.172	0.19				2.30
0.345	0.22				1.99
0.689	0.26				1.71
1.03	0.28	1	0	0.56	1.55
1.38	0.30				1.45
2.07	0.34				1.31
3.45	0.38				1.15
5.17	0.42				1.04
6.89	0.44				1.00

Static equivalent radial load

$P_{0r} = 0.6 F_r + 0.5 F_a$
When $P_{0r} < F_r$ use $P_{0r} = F_r$.

Snap ring groove dimensions				Snap ring dimensions		Installation-related dimensions								Mass
mm				mm		mm								kg
D ₁	a	b	r _o	D ₂	f	d _a	D _a	D _X	C _Y	C _Z	r _{as}	r _{Nas}	With snap ring (approx.)	
Max.	Max.	Min.	Max.	Max.	Max.	Min.	Max.	Max. (approx.)	Max.	Min.	Max.	Max.		
12.15	0.88	0.55	0.2	15.2	0.55	6.6	6.9	11.4	15.9	1.2	0.6	0.2	0.1	0.002
13.03	1.28	0.65	0.06	16.13	0.54	6.6	7.4	12.4	16.9	1.6	0.6	0.2	0.2	0.004
11.15	0.78	0.60	0.02	14.2	0.55	7.2	7.9	10.8	14.9	1.1	0.6	0.15	0.1	0.001
12.15	1.08	0.55	0.2	15.2	0.55	7	7.2	11.8	15.9	1.4	0.6	0.15	0.1	0.002
14.03	1.03	0.65	0.06	17.2	0.6	7.6	7.8	13.4	17.9	1.4	0.7	0.2	0.2	0.004
17.9	0.93	0.80	0.2	22	0.7	8	9.5	17	22.8	1.4	0.7	0.3	0.3	0.008
14.95	0.53	0.65	0.05	18.2	0.54	9.6	10	14.4	18.9	0.9	0.6	0.2	0.1	0.003
20.8	2.35	0.80	0.2	24.8	0.7	10	12.7	20	25.5	2.8	0.7	0.3	0.4	0.013
24.5	2.20	0.90	0.3	28.8	0.85	12	13.5	24	29.5	2.8	0.9	0.3	0.3	0.02

Angular Contact Ball Bearings



Angular contact ball bearing Four-point contact ball bearing Double row angular contact ball bearing

1. Design features and characteristics

1.1 Angular contact ball bearing

Angular contact ball bearings are non-separable bearings with a defined contact angle in the radial direction relative to the straight line that runs through the point where each ball makes contact with the inner and outer rings (see Fig. 1). Table 1 provides information on contact angles and their designated codes.

In addition to radial loads, angular contact ball bearings can accommodate single direction axial loads. Since an axial load is generated from a radial force, these bearings are generally used in pairs. Table 2 shows general angular contact ball bearing characteristics, Table 3 shows information on using duplex (side by side) angular contact ball bearings, and Table 4 shows information on multiple-row angular contact ball bearings.

For bearings with a contact angle of 15° and bearing tolerance JIS Class 5 or higher, see special catalog "Precision rolling bearings (CAT. No. 2260/E)".

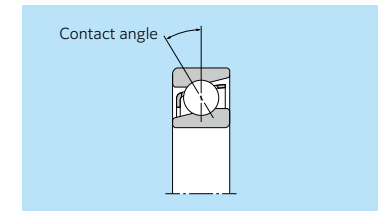

Fig. 1

Table 1 Contact angle and contact angle codes

Contact angle	15°	30°	40°
Contact angle code	C	A ¹⁾	B

1) Contact angle symbol A is omitted from part number.

Table 2 Angular contact ball bearing types and characteristics

Type	Design	Characteristics
Standard type		<ul style="list-style-type: none"> Available in bearing series 79, 70, 72, 72B, 73, and 73B. Contact angles: 30° and 40° (with B) available. Standard bearing cage type differs depending on bearing number. (see Table 5)

Table 3 Duplex angular contact ball bearings — types and characteristics

Duplex type	Characteristics
Back-to-back arrangement (DB) 	<ul style="list-style-type: none"> Can accommodate radial loads and axial loads in either direction. Has a large distance between the acting load centers of the bearings, and therefore a large momentary force load capacity. Allowable misalignment angle is small.
Face-to-face arrangement (DF) 	<ul style="list-style-type: none"> Can accommodate radial loads and axial loads in either direction. Has a smaller distance between the acting load centers of the bearings, and therefore a smaller momentary force load capacity. Has a larger allowable misalignment angle than back-to-back duplex type.
Tandem arrangement (DT) 	<ul style="list-style-type: none"> Can accommodate radial loads and single direction axial loads. Axial loads are received by both bearings as a set, and therefore heavy axial loads can be accommodated.

Note: 1. Duplex angular contact ball bearings are manufactured in a set to specified clearance and preload values; therefore, they must be assembled side by side with identically numbered bearings and not be mixed with other arrangements.

2. To satisfy specified clearance and preload values, tightening must be performed until the inner ring width surfaces or outer ring width surfaces come in contact with each other.

Table 4 Combination examples of multiple-row angular contact ball bearings

Duplex type	3-row arrangement	4-row arrangement
Back-to-back arrangement	(DBT)	(DTBT)
Face-to-face arrangement	(DFT)	(DTFT)
Tandem arrangement	(DTT)	(DTTT)

Note: Other combinations are also available. Consult **NTN Engineering** for details.

1.2 Four-point angular contact ball bearings

Four-point angular contact ball bearings have a contact angle of 30° and a split inner ring. As shown in **Fig. 2**, when the inner and outer rings receive a radial load, the ball contacts the inner and outer rings at four points. This construction enables a single bearing to accommodate axial loads from either direction, and when under a simple axial load or heavy axial load, the bearing relies on two contact points like ordinary bearings.

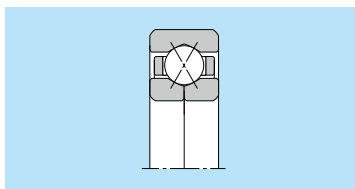

Fig. 2

■ Flush ground

“Flush ground” is the name given to the finishing method shown in **Fig. 3** where the offset of the front and back faces of the bearing are ground to the same value. This allows a designated clearance or preload value to be achieved when using bearings with identical codes in DB or DF orientations. DT series bearings can also be used in various arrangements to achieve uniform load distribution.

General angular contact ball bearings are not flush ground. If it is necessary to flush grind any of these other bearings, please consult **NTN Engineering**.

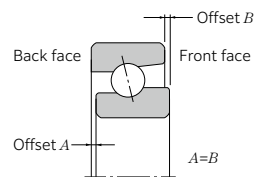

Fig. 3

1.3 Double row angular contact ball bearings

The structure of double row angular contact ball bearings is designed by arranging two single row angular contact bearings back-to-back in duplex (DB) to form a single bearing with a contact angle of 25°.

These bearings are capable of accommodating radial loads, axial loads in either direction, and have a high capacity for moment loads.

As shown in **Fig. 4**, sealed and shielded type double row angular contact ball bearings are also available. Standard loads vary from those of open type bearings.

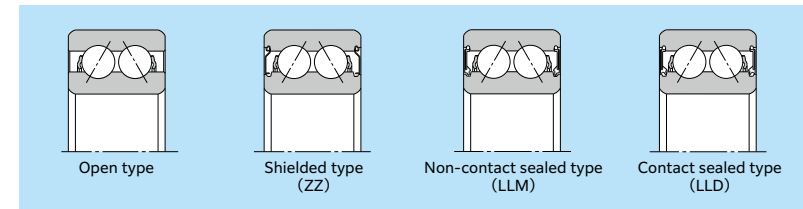

Fig. 4

2. Standard cage type

Table 5 lists the standard cage types for angular contact ball bearings.

Table 5 Standard cages for angular contact ball bearings

Type	Bearing series	Resin cage	Pressed steel cage	Machined cage
Standard type	79	7904~7913 7000~7024	—	7914~7960 7026~7040 7224~7240 7324~7340 7224B~7240B 7324B~7340B
	70		—	
	72		7200~7222	
	73		7200B~7222B	
	72B		7300~7322	
	73B		7200B~7222B 7300B~7322B	
4-point contact	QJ2	—	—	QJ208~QJ224 QJ306~QJ324
	QJ3	—	—	
Multi row	52	—	5200S~5217S 5302S~5314S	—
	53	—		—

Note: Depending on the usage conditions, some cage types may not be suitable. For example, due to the material characteristics of resin cages, use at application temperatures in excess of 120°C is not possible. For details, please contact **NTN Engineering**.

●Single and Duplex Angular Contact Ball Bearings



●Single and Duplex Angular Contact Ball Bearings

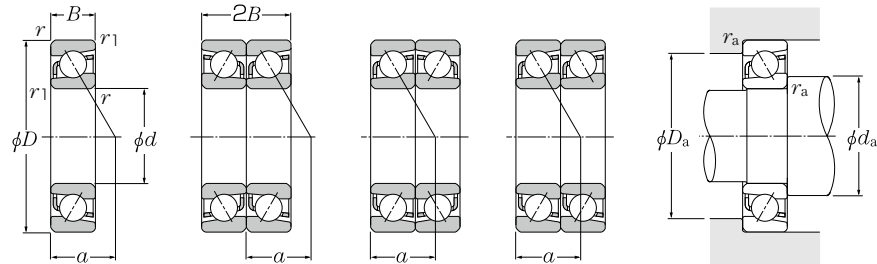

Single row Back-to-back arrangement (DB) Face-to-face arrangement (DF) Tandem arrangement (DT)

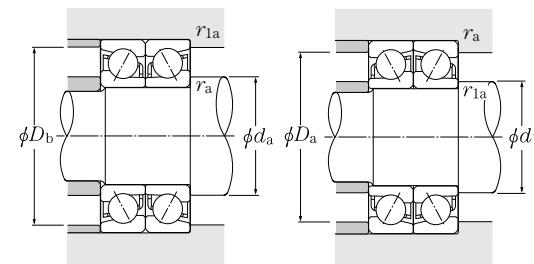

DB, DF

a 10 ~ 30mm

	Boundary dimensions					Basic load rating		Fatigue load limit	Allowable speed ¹⁾		Bearing number ²⁾	Load center	Mass
	d	D	B	2B	r _s min ³⁾	r _{ls} min ³⁾	C _r	C _{0r}	C _u	Grease lubrication	Oil lubrication	a	Single row (approx.)
10	26	8	16	0.3	0.15	5.10	2.07	0.162	29 000	39 000	7000	9	0.023
	30	9	18	0.6	0.3	6.00	2.74	0.214	28 000	37 000	7200	10.5	0.029
	30	9	18	0.6	0.3	5.50	2.52	0.197	24 000	32 000	7200B	13	0.029
	35	11	22	0.6	0.3	11.2	4.95	0.385	26 000	34 000	7300	12	0.04
	35	11	22	0.6	0.3	10.5	4.60	0.360	22 000	29 000	7300B	15	0.041
12	28	8	16	0.3	0.15	5.60	2.46	0.193	26 000	35 000	7001	10	0.025
	32	10	20	0.6	0.3	8.40	3.95	0.310	25 000	33 000	7201	11.5	0.035
	32	10	20	0.6	0.3	7.75	3.65	0.287	21 000	28 000	7201B	14	0.036
	37	12	24	1	0.6	12.4	5.25	0.410	23 000	30 000	7301	13	0.044
	37	12	24	1	0.6	11.7	4.95	0.385	19 000	26 000	7301B	16.5	0.045
15	32	9	18	0.3	0.15	6.40	3.15	0.246	23 000	31 000	7002	11.5	0.035
	35	11	22	0.6	0.3	10.0	4.70	0.370	22 000	29 000	7202	12.5	0.046
	35	11	22	0.6	0.3	9.25	4.35	0.340	18 000	25 000	7202B	16	0.046
	42	13	26	1	0.6	14.9	7.20	0.560	19 000	26 000	7302	15	0.055
	42	13	26	1	0.6	13.8	6.65	0.520	17 000	22 000	7302B	19	0.057
17	35	10	20	0.3	0.15	7.95	3.85	0.299	21 000	28 000	7003	12.5	0.046
	40	12	24	0.6	0.3	13.2	6.60	0.515	19 000	26 000	7203	14.5	0.064
	40	12	24	0.6	0.3	12.2	6.10	0.480	17 000	22 000	7203B	18	0.066
	47	14	28	1	0.6	17.7	8.65	0.675	18 000	24 000	7303	16	0.107
	47	14	28	1	0.6	16.4	8.05	0.630	15 000	20 000	7303B	20.5	0.109
20	42	12	24	0.6	0.3	10.7	5.60	0.440	19 000	25 000	7004	15	0.08
	47	14	28	1	0.6	16.1	8.40	0.655	17 000	23 000	7204	17	0.1
	47	14	28	1	0.6	14.7	7.70	0.605	15 000	20 000	7204B	21.5	0.102
	52	15	30	1.1	0.6	20.7	10.4	0.815	16 000	21 000	7304	18	0.138
	52	15	30	1.1	0.6	19.2	9.65	0.755	13 000	18 000	7304B	22.5	0.141
25	42	9	18	0.3	0.15	7.90	4.95	0.360	17 000	22 000	7905	14	0.05
	47	12	24	0.6	0.3	11.9	6.85	0.535	16 000	21 000	7005	16.5	0.093
	52	15	30	1	0.6	18.0	10.3	0.805	14 000	19 000	7205	19	0.125
	52	15	30	1	0.6	16.4	9.40	0.740	12 000	16 000	7205B	24	0.129
	62	17	34	1.1	0.6	29.3	15.8	1.24	13 000	17 000	7305	21	0.23
62	17	34	1.1	0.6	27.0	14.6	1.14	11 000	15 000	7305B	27	0.234	
30	47	9	18	0.3	0.15	8.35	5.75	0.395	14 000	19 000	7906	15.5	0.058
	55	13	26	1	0.6	15.4	9.45	0.725	13 000	18 000	7006	19	0.135

1) This value achieved with machined cages; when pressed cages are used, 80% of this value is acceptable. 2) Bearing numbers appended with the code "B" have a contact angle of 40°; bearings without this code have a contact angle of 30°. 3) Smallest allowable dimension for chamfer dimension r or r₁.

Dynamic equivalent radial load

$$P_r = X F_r + Y F_a$$

Contact angle	e	Single, DT				DB, DF			
		F _a /F _r ≤ e		F _a /F _r > e		F _a /F _r ≤ e		F _a /F _r > e	
		X	Y	X	Y	X	Y	X	Y
30°	0.80	1	0	0.39	0.76	1	0.78	0.63	1.24
40°	1.14	1	0	0.35	0.57	1	0.55	0.57	0.93

Static equivalent radial load

$$P_{0r} = X_0 F_r + Y_0 F_a$$

Contact angle	Single, DT		DB, DF	
	X ₀	Y ₀	X ₀	Y ₀
30°	0.5	0.33	1	0.66
40°	0.5	0.26	1	0.52

For single and DT arrangement, when P_{0r} < F_r use P_{0r} = F_r.

Basic load rating		Allowable speed ¹⁾		Bearing number			Installation-related dimensions						
dynamic	static	(duplex)		DB	DF	DT	d _a	d _b	D _a	mm		r _{as}	r _{1as}
(duplex)	(duplex)	Grease lubrication	Oil lubrication				Min.	Min.	Max.	D _b	Max.	Max.	Max.
8.30	4.15	23 000	31 000	DB	DF	DT	12.5	12.5	23.5	24.8	0.3	0.15	
9.75	5.45	22 000	30 000	DB	DF	DT	14.5	12.5	25.5	27.5	0.6	0.3	
8.95	5.05	19 000	26 000	DB	DF	DT	14.5	12.5	25.5	27.5	0.6	0.3	
18.2	9.85	20 000	27 000	DB	DF	DT	14.5	12.5	30.5	32.5	0.6	0.3	
17.1	9.20	18 000	24 000	DB	DF	DT	14.5	12.5	30.5	32.5	0.6	0.3	
9.10	4.90	21 000	28 000	DB	DF	DT	14.5	14.5	25.5	26.8	0.3	0.15	
13.7	7.95	20 000	26 000	DB	DF	DT	16.5	14.5	27.5	29.5	0.6	0.3	
12.6	7.35	17 000	23 000	DB	DF	DT	16.5	14.5	27.5	29.5	0.6	0.3	
20.1	10.5	18 000	24 000	DB	DF	DT	17.5	16.5	31.5	32.5	1	0.6	
19.0	9.90	16 000	21 000	DB	DF	DT	17.5	16.5	31.5	32.5	1	0.6	
10.4	6.30	18 000	24 000	DB	DF	DT	17.5	17.5	29.5	30.8	0.3	0.15	
16.3	9.40	17 000	23 000	DB	DF	DT	19.5	17.5	30.5	32.5	0.6	0.3	
15.1	8.70	15 000	20 000	DB	DF	DT	19.5	17.5	30.5	32.5	0.6	0.3	
24.2	14.4	15 000	21 000	DB	DF	DT	20.5	19.5	36.5	37.5	1	0.6	
22.5	13.3	13 000	18 000	DB	DF	DT	20.5	19.5	36.5	37.5	1	0.6	
12.9	7.65	17 000	22 000	DB	DF	DT	19.5	19.5	32.5	33.8	0.3	0.15	
21.5	13.2	15 000	21 000	DB	DF	DT	21.5	19.5	35.5	37.5	0.6	0.3	
19.8	12.2	13 000	18 000	DB	DF	DT	21.5	19.5	35.5	37.5	0.6	0.3	
28.7	17.3	14 000	19 000	DB	DF	DT	22.5	21.5	41.5	42.5	1	0.6	
26.6	16.1	12 000	16 000	DB	DF	DT	22.5	21.5	41.5	42.5	1	0.6	
17.5	11.2	15 000	20 000	DB	DF	DT	24.5	24.5	37.5	39.5	0.6	0.3	
26.1	16.8	14 000	18 000	DB	DF	DT	25.5	24.5	41.5	42.5	1	0.6	
23.9	15.4	12 000	16 000	DB	DF	DT	25.5	24.5	41.5	42.5	1	0.6	
33.5	20.8	12 000	17 000	DB	DF	DT	27	24.5	45	47.5	1	0.6	
31.0	19.3	11 000	14 000	DB	DF	DT	27	24.5	45	47.5	1	0.6	
12.9	9.95	13 000	18 000	DB	DF	DT	27.5	27.5	39.5	40.8	0.3	0.15	
19.3	13.7	12 000	17 000	DB	DF	DT	29.5	29.5	42.5	44.5	0.6	0.3	
29.2	20.6	11 000	15 000	DB	DF	DT	30.5	29.5	46.5	47.5	1	0.6	
26.6	18.8	10 000	13 000	DB	DF	DT	30.5	29.5	46.5	47.5	1	0.6	
47.5	31.5	10 000	14 000	DB	DF	DT	32	29.5	55	57.5	1	0.6	
44.0	29.3	9 100	12 000	DB	DF	DT	32	29.5	55	57.5	1	0.6	
13.6	11.5	12 000	15 000	DB	DF	DT	32.5	32.5	44.5	45.8	0.3	0.15	
25.0	18.9	11 000	14 000	DB	DF	DT	35.5	35.5	49.5	50.5	1	0.6	

Note: For bearing series 79 and 70, inner rings are constructed with groove abutments on both sides. Therefore, the inner ring chamfer dimension r₁ is identical to dimension r. Furthermore, the radius r_{1a} of the shaft corner roundness is likewise identical to r_a.

Single and Duplex Angular Contact Ball Bearings

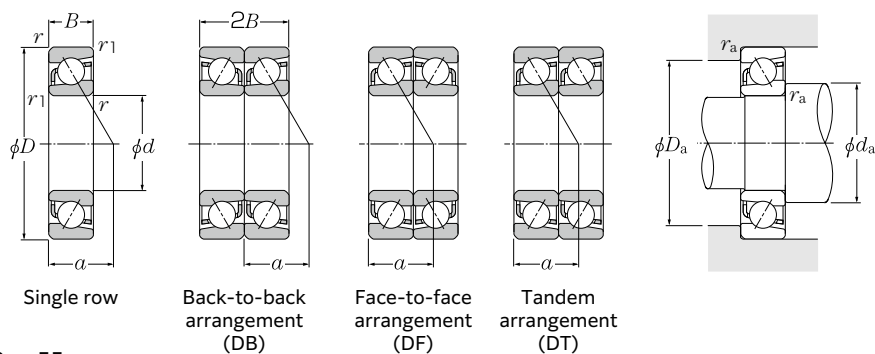

a 30 ~ 55mm

d	Boundary dimensions					Basic load rating		Fatigue load limit kN C _u	Allowable speed ¹⁾		Bearing number ²⁾	Load center mm a	Mass kg
	D	B	2B	r _{s min} ³⁾	r _{ls min} ³⁾	dynamic kN C _r	static kN C _{0r}		Grease min ⁻¹	Oil min ⁻¹			
	mm	mm	mm	mm	mm	kN	kN						
30	62	16	32	1	0.6	24.9	14.8	1.16	12 000	16 000	7206	21.5	0.193
	62	16	32	1	0.6	22.7	13.5	1.06	11 000	14 000	7206B	27.5	0.197
	72	19	38	1.1	0.6	37.5	22.3	1.75	11 000	15 000	7306	24.5	0.345
	72	19	38	1.1	0.6	34.0	20.5	1.61	9 600	13 000	7306B	31.5	0.352
35	55	10	20	0.6	0.3	13.3	8.85	0.640	13 000	17 000	7907	18	0.088
	62	14	28	1	0.6	19.4	12.6	0.955	12 000	16 000	7007	21	0.18
	72	17	34	1.1	0.6	33.0	20.1	1.57	11 000	14 000	7207	24	0.281
	72	17	34	1.1	0.6	30.0	18.4	1.44	9 300	12 000	7207B	31	0.287
	80	21	42	1.5	1	44.0	26.3	2.05	9 800	13 000	7307	27	0.462
80	21	42	1.5	1	40.5	24.2	1.89	8 400	11 000	7307B	34.5	0.469	
40	62	12	24	0.6	0.3	14.0	10.2	0.705	11 000	15 000	7908	20.5	0.13
	68	15	30	1	0.6	20.8	14.6	1.07	10 000	14 000	7008	23	0.222
	80	18	36	1.1	0.6	39.0	25.1	1.97	9 600	13 000	7208	26.5	0.355
	80	18	36	1.1	0.6	35.5	23.0	1.80	8 300	11 000	7208B	34	0.375
	90	23	46	1.5	1	54.0	33.0	2.58	8 600	12 000	7308	30.5	0.625
90	23	46	1.5	1	49.5	30.5	2.37	7 400	9 900	7308B	39	0.636	
45	68	12	24	0.6	0.3	17.4	12.9	0.895	10 000	14 000	7909	22.5	0.15
	75	16	32	1	0.6	24.7	17.7	1.29	9 500	13 000	7009	25.5	0.282
	85	19	38	1.1	0.6	44.0	28.7	2.25	8 700	12 000	7209	28.5	0.404
	85	19	38	1.1	0.6	40.0	26.2	2.04	7 400	9 900	7209B	37	0.41
	100	25	50	1.5	1	70.5	44.0	3.45	7 800	10 000	7309	33.5	0.837
100	25	50	1.5	1	64.5	40.5	3.15	6 600	8 900	7309B	43	0.854	
50	72	12	24	0.6	0.3	18.4	14.5	0.985	9 200	12 000	7910	23.5	0.157
	80	16	32	1	0.6	26.2	20.1	1.42	8 600	11 000	7010	27	0.306
	90	20	40	1.1	0.6	45.5	31.5	2.46	7 900	10 000	7210	30	0.457
	90	20	40	1.1	0.6	41.5	28.6	2.16	6 700	9 000	7210B	39.5	0.466
	110	27	54	2	1	82.5	52.5	4.10	7 100	9 400	7310	36.5	1.09
110	27	54	2	1	75.5	48.5	3.80	6 000	8 100	7310B	47	1.11	
55	80	13	26	1	0.6	19.2	16.1	1.07	8 400	11 000	7911	26	0.214
	90	18	36	1.1	0.6	34.5	26.3	1.90	7 900	11 000	7011	30	0.447
	100	21	42	1.5	1	56.5	39.5	3.10	7 100	9 500	7211	33	0.6
	100	21	42	1.5	1	51.5	36.0	2.74	6 100	8 200	7211B	43	0.612
	120	29	58	2	1	95.0	61.5	4.80	6 400	8 600	7311	40	1.39
120	29	58	2	1	87.0	56.5	4.45	5 500	7 300	7311B	52	1.42	

1) This value achieved with machined cages; when pressed cages are used, 80% of this value is acceptable. 2) Bearing numbers appended with the code "B" have a contact angle of 40°; bearings without this code have a contact angle of 30°. 3) Smallest allowable dimension for chamfer dimension r or r₁.
B-62

Single and Duplex Angular Contact Ball Bearings

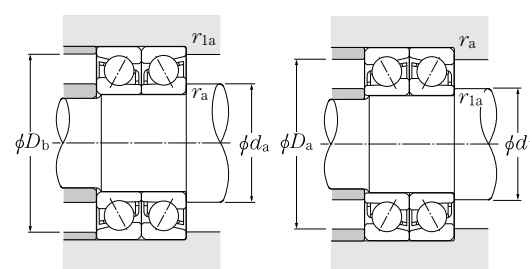

Dynamic equivalent radial load

$$P_r = X F_r + Y F_a$$

Contact angle	e	Single, DT				DB, DF			
		$F_a / F_r \leq e$				$F_a / F_r > e$			
		X	Y	X	Y	X	Y	X	Y
30°	0.80	1	0	0.39	0.76	1	0.78	0.63	1.24
40°	1.14	1	0	0.35	0.57	1	0.55	0.57	0.93

Static equivalent radial load

$$P_{0r} = X_0 F_r + Y_0 F_a$$

Contact angle	Single, DT		DB, DF	
	X ₀	Y ₀	X ₀	Y ₀
	30°	0.5	0.33	1
40°	0.5	0.26	1	0.52

For single and DT arrangement, when $P_{0r} < F_r$ use $P_{0r} = F_r$.

Basic load rating		Allowable speed ¹⁾		Bearing number			Installation-related dimensions					
dynamic (duplex) kN C _r	static (duplex) kN C _{0r}	(duplex) min ⁻¹		DB	DF	DT	d _a Min.	d _b Min.	D _a Max.	mm D _b Max.	r _{as} Max.	r _{1as} Max.
		Grease lubrication	Oil lubrication									
40.5	29.6	9 800	13 000	DB	DF	DT	35.5	34.5	56.5	57.5	1	0.6
37.0	27.1	8 600	11 000	DB	DF	DT	35.5	34.5	56.5	57.5	1	0.6
60.5	44.5	8 900	12 000	DB	DF	DT	37	34.5	65	67.5	1	0.6
55.5	41.0	7 700	10 000	DB	DF	DT	37	34.5	65	67.5	1	0.6
21.6	17.7	10 000	13 000	DB	DF	DT	39.5	39.5	50.5	52.5	0.6	0.3
31.5	25.1	9 400	13 000	DB	DF	DT	40.5	40.5	56.5	57.5	1	0.6
53.5	40.0	8 600	11 000	DB	DF	DT	42	39.5	65	67.5	1	0.6
49.0	36.5	7 500	10 000	DB	DF	DT	42	39.5	65	67.5	1	0.6
72.0	52.5	7 800	10 000	DB	DF	DT	43.5	40.5	71.5	74.5	1.5	1
66.0	48.5	6 800	9 000	DB	DF	DT	43.5	40.5	71.5	74.5	1.5	1
22.8	20.4	9 000	12 000	DB	DF	DT	44.5	44.5	57.5	59.5	0.6	0.3
34.0	29.2	8 300	11 000	DB	DF	DT	45.5	45.5	62.5	63.5	1	0.6
63.5	50.5	7 700	10 000	DB	DF	DT	47	44.5	73	75.5	1	0.6
58.0	46.0	6 700	8 900	DB	DF	DT	47	44.5	73	75.5	1	0.6
88.0	66.0	6 900	9 200	DB	DF	DT	48.5	45.5	81.5	84.5	1.5	1
80.5	60.5	6 000	8 000	DB	DF	DT	48.5	45.5	81.5	84.5	1.5	1
28.3	25.7	8 100	11 000	DB	DF	DT	49.5	49.5	63.5	65.5	0.6	0.3
40.0	35.5	7 500	10 000	DB	DF	DT	50.5	50.5	69.5	70.5	1	0.6
71.5	57.5	6 900	9 200	DB	DF	DT	52	49.5	78	80.5	1	0.6
65.0	52.5	6 000	8 000	DB	DF	DT	52	49.5	78	80.5	1	0.6
114	88.0	6 200	8 200	DB	DF	DT	53.5	50.5	91.5	94.5	1.5	1
105	81.0	5 400	7 200	DB	DF	DT	53.5	50.5	91.5	94.5	1.5	1
29.9	28.9	7 300	9 800	DB	DF	DT	54.5	54.5	67.5	69.5	0.6	0.3
42.5	40.0	6 800	9 100	DB	DF	DT	55.5	55.5	74.5	75.5	1	0.6
74.5	63.0	6 300	8 300	DB	DF	DT	57	54.5	83	85.5	1	0.6
67.5	57.0	5 500	7 300	DB	DF	DT	57	54.5	83	85.5	1	0.6
134	105	5 600	7 500	DB	DF	DT	60	55.5	100	104.5	2	1
123	96.5	4 900	6 500	DB	DF	DT	60	55.5	100	104.5	2	1
31.0	32.0	6 700	8 900	DB	DF	DT	60.5	60.5	74.5	75.5	1	0.6
56.0	52.5	6 300	8 400	DB	DF	DT	62	62	83	85.5	1	0.6
92.0	79.0	5 700	7 600	DB	DF	DT	63.5	60.5	91.5	94.5	1.5	1
83.5	72.0	5 000	6 600	DB	DF	DT	63.5	60.5	91.5	94.5	1.5	1
154	123	5 100	6 800	DB	DF	DT	65	60.5	110	114.5	2	1
142	113	4 500	5 900	DB	DF	DT	65	60.5	110	114.5	2	1

Note: For bearing series 79 and 70, inner rings are constructed with groove abutments on both sides. Therefore, the inner ring chamfer dimension r₁ is identical to dimension r. Furthermore, the radius r_{1a} of the shaft corner roundness is likewise identical to r_a.
B-63

Single and Duplex Angular Contact Ball Bearings

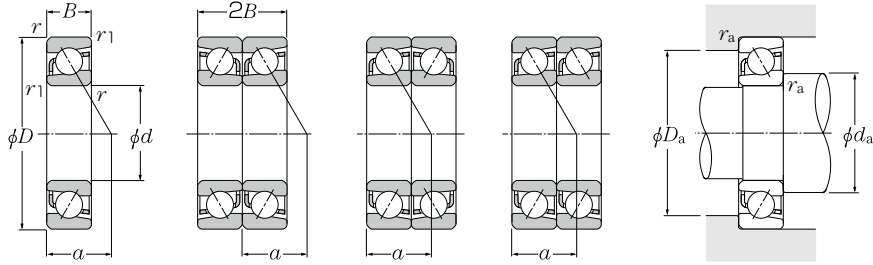

Single row
Back-to-back arrangement (DB)
Face-to-face arrangement (DF)
Tandem arrangement (DT)

a 60 ~ 85mm

d	Boundary dimensions					Basic load rating		Fatigue load limit kN C_u	Allowable speed ¹⁾		Bearing number ²⁾	Load center mm a	Mass kg
	mm					dynamic kN C_R	static kN C_{0R}		min ⁻¹	Oil lubrication			
	D	B	2B	r_s min ³⁾	r_{ls} min ³⁾								
60	85	13	26	1	0.6	20.0	17.4	1.16	7 800	10 000	7912	27.5	0.23
	95	18	36	1.1	0.6	35.5	28.1	1.99	7 200	9 600	7012	31.5	0.478
	110	22	44	1.5	1	68.5	49.0	3.85	6 600	8 800	7212	36	0.765
	110	22	44	1.5	1	62.0	44.5	3.40	5 700	7 600	7212B	47.5	0.78
	130	31	62	2.1	1.1	109	71.5	5.60	5 900	7 900	7312	43	1.74
	130	31	62	2.1	1.1	99.5	66.0	5.15	5 100	6 800	7312B	56	1.77
65	90	13	26	1	0.6	20.2	18.0	1.20	7 200	9 600	7913	29	0.245
	100	18	36	1.1	0.6	37.5	31.5	2.18	6 700	9 000	7013	33	0.509
	120	23	46	1.5	1	78.0	58.0	4.55	6 100	8 100	7213	38	0.962
	120	23	46	1.5	1	70.5	52.5	3.95	5 200	7 000	7213B	50.5	0.981
	140	33	66	2.1	1.1	123	82.0	6.35	5 500	7 300	7313	46	2.11
	140	33	66	2.1	1.1	113	75.5	5.85	4 700	6 300	7313B	59.5	2.15
70	100	16	32	1	0.6	29.0	26.2	1.74	6 700	9 000	7914	32.5	0.397
	110	20	40	1.1	0.6	47.5	39.5	2.78	6 200	8 300	7014	36	0.705
	125	24	48	1.5	1	84.5	63.5	5.00	5 700	7 600	7214	40	1.09
	125	24	48	1.5	1	76.5	58.0	4.35	4 900	6 500	7214B	53	1.11
	150	35	70	2.1	1.1	138	93.5	6.95	5 100	6 800	7314	49.5	2.56
	150	35	70	2.1	1.1	127	86	6.40	4 400	5 800	7314B	63.5	2.61
75	105	16	32	1	0.6	29.4	27.1	1.80	6 300	8 400	7915	34	0.42
	115	20	40	1.1	0.6	48.5	41.5	2.90	5 800	7 800	7015	37.5	0.745
	130	25	50	1.5	1	87.5	68.5	5.20	5 300	7 100	7215	42.5	1.17
	130	25	50	1.5	1	79.0	62.0	4.50	4 500	6 000	7215B	56	1.19
	160	37	74	2.1	1.1	150	106	7.65	4 800	6 300	7315	52.5	3.07
	160	37	74	2.1	1.1	138	97.5	7.00	4 100	5 400	7315B	68	3.13
80	110	16	32	1	0.6	29.8	28.0	1.86	5 900	7 800	7916	35.5	0.444
	125	22	44	1.1	0.6	59.0	50.5	3.50	5 500	7 300	7016	40.5	0.994
	140	26	52	2	1	98.5	76.0	5.65	5 000	6 600	7216	45	1.39
	140	26	52	2	1	89.0	69.5	4.90	4 300	5 700	7216B	59	1.42
	170	39	78	2.1	1.1	163	119	8.30	4 500	5 900	7316	55.5	3.65
	170	39	78	2.1	1.1	149	109	7.65	3 800	5 100	7316B	72	3.72
85	120	18	36	1.1	0.6	40.0	38.0	2.49	5 500	7 400	7917	38.5	0.628
	130	22	44	1.1	0.6	60.5	53.5	3.60	5 100	6 900	7017	42	1.04
	150	28	56	2	1	110	88.5	6.25	4 700	6 200	7217	48	1.78
	150	28	56	2	1	99.5	80.5	5.45	4 000	5 300	7217B	63.5	1.82

1) This value achieved with machined cages; when pressed cages are used, 80% of this value is acceptable. 2) Bearing numbers appended with the code "B" have a contact angle of 40°; bearings without this code have a contact angle of 30°. 3) Smallest allowable dimension for chamfer dimension r or r₁.
B-64

Single and Duplex Angular Contact Ball Bearings

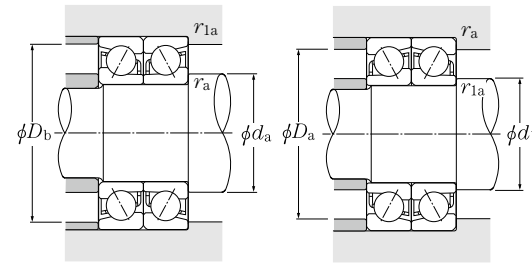

Dynamic equivalent radial load

$$P_r = XF_r + YF_a$$

Contact angle	e	Single, DT				DB, DF			
		$F_a/F_r \leq e$		$F_a/F_r > e$		$F_a/F_r \leq e$		$F_a/F_r > e$	
		X	Y	X	Y	X	Y	X	Y
30°	0.80	1	0	0.39	0.76	1	0.78	0.63	1.24
40°	1.14	1	0	0.35	0.57	1	0.55	0.57	0.93

Static equivalent radial load

$$P_{0r} = X_0 F_r + Y_0 F_a$$

Contact angle	Single, DT		DB, DF	
	X_0	Y_0	X_0	Y_0
	30°	0.5	0.33	1
40°	0.5	0.26	1	0.52

For single and DT arrangement, when $P_{0r} < F_r$ use $P_{0r} = F_r$.

Basic load rating	dynamic	static	Allowable speed ¹⁾	Bearing number			Installation-related dimensions									
				(duplex)			DB	DF	DT	d_a	d_b	D_a	mm		r_{as}	r_{1as}
				C_R	C_{0R}	min ⁻¹							Grease	Oil		
32.5	35.0	6 200	8 300	DB	DF	DT	65.5	65.5	79.5	80.5	1	0.6				
57.5	56.0	5 800	7 700	DB	DF	DT	67	67	88	90.5	1	0.6				
111	98.0	5 300	7 000	DB	DF	DT	68.5	65.5	101.5	104.5	1.5	1				
101	89.0	4 600	6 100	DB	DF	DT	68.5	65.5	101.5	104.5	1.5	1				
176	143	4 700	6 300	DB	DF	DT	72	67	118	123	2	1				
162	132	4 100	5 500	DB	DF	DT	72	67	118	123	2	1				
33.0	36.0	5 700	7 600	DB	DF	DT	70.5	70.5	84.5	85.5	1	0.6				
60.5	62.5	5 400	7 100	DB	DF	DT	72	72	93	95.5	1	0.6				
126	116	4 900	6 500	DB	DF	DT	73.5	70.5	111.5	114.5	1.5	1				
115	105	4 200	5 600	DB	DF	DT	73.5	70.5	111.5	114.5	1.5	1				
200	164	4 400	5 800	DB	DF	DT	77	72	128	133	2	1				
183	151	3 800	5 100	DB	DF	DT	77	72	128	133	2	1				
47.0	52.5	5 300	7 100	DB	DF	DT	75.5	75.5	94.5	95.5	1	0.6				
77.0	78.5	5 000	6 600	DB	DF	DT	77	77	103	105.5	1	0.6				
137	127	4 500	6 000	DB	DF	DT	78.5	75.5	116.5	119.5	1.5	1				
124	116	3 900	5 200	DB	DF	DT	78.5	75.5	116.5	119.5	1.5	1				
224	187	4 100	5 400	DB	DF	DT	82	77	138	143	2	1				
206	172	3 500	4 700	DB	DF	DT	82	77	138	143	2	1				
48.0	54.0	5 000	6 700	DB	DF	DT	80.5	80.5	99.5	100.5	1	0.6				
78.5	83.5	4 600	6 200	DB	DF	DT	82	82	108	110.5	1	0.6				
142	137	4 200	5 600	DB	DF	DT	83.5	80.5	121.5	124.5	1.5	1				
128	124	3 700	4 900	DB	DF	DT	83.5	80.5	121.5	124.5	1.5	1				
244	212	3 800	5 000	DB	DF	DT	87	82	148	153	2	1				
224	195	3 300	4 400	DB	DF	DT	87	82	148	153	2	1				
48.5	56.0	4 700	6 200	DB	DF	DT	85.5	85.5	104.5	105.5	1	0.6				
96.0	101	4 400	5 800	DB	DF	DT	87	87	118	120.5	1	0.6				
160	152	3 900	5 300	DB	DF	DT	90	85.5	130	134.5	2	1				
145	139	3 400	4 600	DB	DF	DT	90	85.5	130	134.5	2	1				
265	238	3 500	4 700	DB	DF	DT	92	87	158	163	2	1				
243	218	3 100	4 100	DB	DF	DT	92	87	158	163	2	1				
65.0	76.0	4 400	5 900	DB	DF	DT	92	92	113	115.5	1	0.6				
98.5	107	4 100	5 500	DB	DF	DT	92	92	123	125.5	1	0.6				
179	177	3 700	5 000	DB	DF	DT	95	90.5	140	144.5	2	1				
162	161	3 200	4 300	DB	DF	DT	95	90.5	140	144.5	2	1				

Note: For bearing series 79 and 70, inner rings are constructed with groove abutments on both sides. Therefore, the inner ring chamfer dimension r₁ is identical to dimension r. Furthermore, the radius r_{1a} of the shaft corner roundness is likewise identical to r_a.
B-65

Single and Duplex Angular Contact Ball Bearings

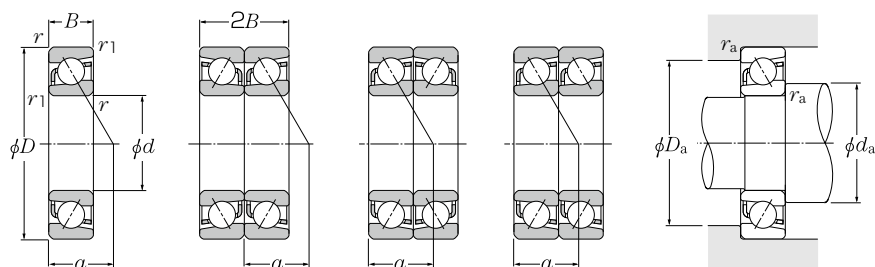

Single row
Back-to-back arrangement (DB)
Face-to-face arrangement (DF)
Tandem arrangement (DT)

d 85 ~ 120mm

d	Boundary dimensions					Basic load rating		Fatigue load limit kN C _u	Allowable speed ¹⁾		Bearing number ²⁾	Load center mm a	Mass kg Single row (approx.)
	mm					dynamic kN C _r	static kN C _{0r}		Grease lubrication min ⁻¹	Oil lubrication min ⁻¹			
	D	B	2B	r _{s min³⁾}									
85	180	41	82	3	1.1	176	133	9.00	4 200	5 600	7317	59	4.34
	180	41	82	3	1.1	161	122	8.30	3 600	4 800	7317B	76	4.43
90	125	18	36	1.1	0.6	39.5	38.0	2.42	5 200	7 000	7918	40	0.658
	140	24	48	1.5	1	72.0	63.5	4.15	4 900	6 500	7018	45	1.35
	160	30	60	2	1	130	103	7.20	4 400	5 900	7218	51	2.18
	160	30	60	2	1	118	94.0	6.30	3 800	5 000	7218B	67.5	2.22
	190	43	86	3	1.1	189	147	9.70	4 000	5 300	7318	62	5.06
95	130	18	36	1.1	0.6	41.5	40.5	2.54	5 000	6 600	7919	41.5	0.688
	145	24	48	1.5	1	74.0	67.0	4.25	4 600	6 100	7019	46.5	1.41
	170	32	64	2.1	1.1	148	118	8.05	4 100	5 500	7219	54.5	2.67
	170	32	64	2.1	1.1	134	107	7.00	3 500	4 700	7219B	71.5	2.72
	200	45	90	3	1.1	202	162	10.5	3 700	5 000	7319	65	5.89
100	140	20	40	1.1	0.6	53.0	52.5	3.20	4 700	6 200	7920	44.5	0.934
	150	24	48	1.5	1	75.5	70.5	4.35	4 400	5 800	7020	48	1.47
	180	34	68	2.1	1.1	159	126	8.30	3 900	5 200	7220	57.5	3.2
	180	34	68	2.1	1.1	144	114	7.30	3 400	4 500	7220B	76	3.26
	215	47	94	3	1.1	230	193	12.0	3 500	4 700	7320	69	7.18
105	145	20	40	1.1	0.6	54.0	54.5	3.25	4 400	5 900	7921	46	0.972
	160	26	52	2	1	88.5	81.5	4.95	4 100	5 500	7021	51.5	1.86
	190	36	72	2.1	1.1	173	142	9.10	3 700	5 000	7221	60.5	3.79
	190	36	72	2.1	1.1	157	129	8.05	3 200	4 300	7221B	80	3.87
	225	49	98	3	1.1	244	210	12.8	3 400	4 500	7321	72	8.2
110	150	20	40	1.1	0.6	54.5	56.0	3.25	4 200	5 700	7922	47.5	1.01
	170	28	56	2	1	102	93.0	5.50	3 900	5 300	7022	54.5	2.3
	200	38	76	2.1	1.1	188	158	9.95	3 500	4 700	7222	64	4.45
	200	38	76	2.1	1.1	170	144	8.80	3 000	4 000	7222B	84	4.54
	240	50	100	3	1.1	273	246	14.5	3 200	4 300	7322	76	9.6
120	240	50	100	3	1.1	250	226	13.3	2 700	3 700	7322B	99	9.8

1) This value achieved with machined cages; when pressed cages are used, 80% of this value is acceptable. 2) Bearing numbers appended with the code "B" have a contact angle of 40°; bearings without this code have a contact angle of 30°. 3) Smallest allowable dimension for chamfer dimension r or r₁.

Single and Duplex Angular Contact Ball Bearings

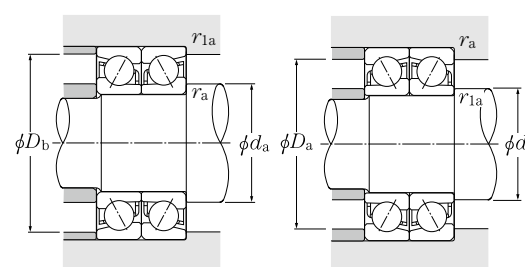

Dynamic equivalent radial load

$$P_r = XF_r + YF_a$$

Contact angle	e	Single, DT				DB, DF			
		F _a /F _r ≤ e		F _a /F _r > e		F _a /F _r ≤ e		F _a /F _r > e	
		X	Y	X	Y	X	Y	X	Y
30°	0.80	1	0	0.39	0.76	1	0.78	0.63	1.24
40°	1.14	1	0	0.35	0.57	1	0.55	0.57	0.93

Static equivalent radial load

$$P_{0r} = X_0 F_r + Y_0 F_a$$

Contact angle	Single, DT		DB, DF	
	X ₀	Y ₀	X ₀	Y ₀
30°	0.5	0.33	1	0.66
40°	0.5	0.26	1	0.52

For single and DT arrangement, when P_{0r} < F_r use P_{0r} = F_r.

Basic load rating		Allowable speed ¹⁾		Bearing number			Installation-related dimensions						
dynamic	static	(duplex)		DB	DF	DT	d _a	d _b	D _a	mm		r _{as}	r _{1as}
C _r	C _{0r}	Grease lubrication	Oil lubrication				Min.	Min.	Max.	D _b	Max.	Max.	Max.
286	265	3 300	4 500	DB	DF	DT	99	92	166	173	2.5	1	
262	244	2 900	3 900	DB	DF	DT	99	92	166	173	2.5	1	
65.5	75.5	4 200	5 500	DB	DF	DT	97	97	118	120.5	1	0.6	
117	127	3 900	5 200	DB	DF	DT	98.5	98.5	131.5	134.5	1.5	1	
212	206	3 500	4 700	DB	DF	DT	100	95.5	150	154.5	2	1	
192	188	3 100	4 100	DB	DF	DT	100	95.5	150	154.5	2	1	
305	294	3 200	4 200	DB	DF	DT	104	97	176	183	2.5	1	
281	270	2 700	3 700	DB	DF	DT	104	97	176	183	2.5	1	
67.0	81.5	3 900	5 300	DB	DF	DT	102	102	123	125.5	1	0.6	
120	134	3 700	4 900	DB	DF	DT	103.5	103.5	136.5	139.5	1.5	1	
240	236	3 300	4 400	DB	DF	DT	107	102	158	163	2	1	
218	215	2 900	3 800	DB	DF	DT	107	102	158	163	2	1	
330	325	3 000	3 900	DB	DF	DT	109	102	186	193	2.5	1	
300	298	2 600	3 400	DB	DF	DT	109	102	186	193	2.5	1	
86.0	105	3 700	5 000	DB	DF	DT	107	107	133	135.5	1	0.6	
123	141	3 500	4 600	DB	DF	DT	108.5	108.5	141.5	144.5	1.5	1	
259	251	3 100	4 200	DB	DF	DT	112	107	168	173	2	1	
234	229	2 700	3 600	DB	DF	DT	112	107	168	173	2	1	
375	385	2 800	3 700	DB	DF	DT	114	107	201	208	2.5	1	
340	355	2 400	3 300	DB	DF	DT	114	107	201	208	2.5	1	
87.5	109	3 500	4 700	DB	DF	DT	112	112	138	140.5	1	0.6	
144	163	3 300	4 400	DB	DF	DT	115	115	150	154.5	2	1	
282	283	3 000	4 000	DB	DF	DT	117	112	178	183	2	1	
255	258	2 600	3 500	DB	DF	DT	117	112	178	183	2	1	
395	420	2 700	3 600	DB	DF	DT	119	112	211	218	2.5	1	
365	385	2 300	3 100	DB	DF	DT	119	112	211	218	2.5	1	
89.0	112	3 400	4 500	DB	DF	DT	117	117	143	145.5	1	0.6	
165	186	3 100	4 200	DB	DF	DT	120	120	160	164.5	2	1	
305	315	2 800	3 800	DB	DF	DT	122	117	188	193	2	1	
277	289	2 500	3 300	DB	DF	DT	122	117	188	193	2	1	
445	490	2 600	3 400	DB	DF	DT	124	117	226	233	2.5	1	
405	455	2 200	3 000	DB	DF	DT	124	117	226	233	2.5	1	
109	139	3 100	4 100	DB	DF	DT	127	127	158	160.5	1	0.6	

Note: For bearing series 79 and 70, inner rings are constructed with groove abutments on both sides. Therefore, the inner ring chamfer dimension r₁ is identical to dimension r. Furthermore, the radius r_{1a} of the shaft corner roundness is likewise identical to r_a.

Single and Duplex Angular Contact Ball Bearings NTN

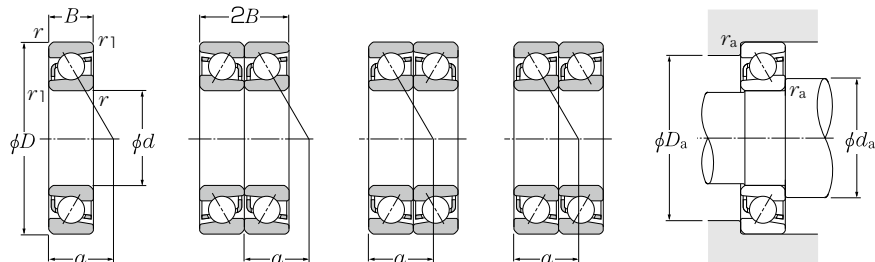

Single row
Back-to-back arrangement (DB)
Face-to-face arrangement (DF)
Tandem arrangement (DT)

d 120 ~ 170mm

d	Boundary dimensions					Basic load rating		Fatigue load limit kN C_u	Allowable speed		Bearing number ¹⁾	Load center mm a	Mass kg Single row (approx.)
	mm					dynamic kN C_r	static kN C_{0r}		Grease lubrication	Oil lubrication			
	D	B	$2B$	$r_s \text{ min}^2)$	$r_{ls} \text{ min}^2)$								
120	180	28	56	2	1	104	98.5	5.55	3 600	4 800	7024	57.5	2.47
	215	40	80	2.1	1.1	202	177	10.7	3 200	4 300	7224	68.5	6.26
	215	40	80	2.1	1.1	183	162	9.40	2 800	3 700	7224B	90.5	6.26
	260	55	110	3	1.1	273	252	14.3	2 900	3 900	7324	82.5	14.7
	260	55	110	3	1.1	249	231	13.1	2 500	3 300	7324B	107	14.7
130	180	24	48	1.5	1	83.0	87.5	4.65	3 600	4 700	7926	56.5	1.82
	200	33	66	2	1	130	125	6.75	3 300	4 400	7026	64	3.73
	230	40	80	3	1.1	217	198	11.5	3 000	4 000	7226	72	7.15
	230	40	80	3	1.1	196	180	10.0	2 500	3 400	7226B	95.5	7.15
	280	58	116	4	1.5	305	293	16.0	2 700	3 600	7326	88	17.6
280	58	116	4	1.5	277	268	14.7	2 300	3 100	7326B	115	17.6	
140	190	24	48	1.5	1	83.5	90.0	4.65	3 300	4 400	7928	59.5	1.94
	210	33	66	2	1	133	133	6.85	3 100	4 100	7028	67	3.96
	250	42	84	3	1.1	225	215	11.7	2 700	3 600	7228	77.5	8.78
	250	42	84	3	1.1	203	195	10.1	2 300	3 100	7228B	103	8.78
	300	62	124	4	1.5	335	335	17.7	2 500	3 300	7328	94.5	21.5
300	62	124	4	1.5	305	310	16.3	2 100	2 800	7328B	123	21.5	
150	210	28	56	2	1	108	117	5.80	3 100	4 100	7930	66	2.96
	225	35	70	2.1	1.1	152	154	7.65	2 800	3 800	7030	71.5	4.82
	270	45	90	3	1.1	257	259	13.7	2 500	3 400	7230	83	11
	270	45	90	3	1.1	232	235	11.9	2 200	2 900	7230B	111	11
	320	65	130	4	1.5	365	380	19.5	2 300	3 100	7330	100	25.1
320	65	130	4	1.5	335	350	17.9	2 000	2 600	7330B	131	25.1	
160	220	28	56	2	1	109	121	5.80	2 800	3 800	7932	69	3.13
	240	38	76	2.1	1.1	172	176	8.55	2 700	3 600	7032	77	5.96
	290	48	96	3	1.1	291	305	15.8	2 400	3 200	7232	89	13.7
	290	48	96	3	1.1	263	279	13.7	2 000	2 700	7232B	118	13.7
	340	68	136	4	1.5	385	420	20.9	2 100	2 800	7332	106	29.8
340	68	136	4	1.5	350	385	19.1	1 800	2 400	7332B	139	29.8	
170	230	28	56	2	1	115	129	6.05	2 700	3 600	7934	71.5	3.29
	260	42	84	2.1	1.1	206	214	10.2	2 500	3 300	7034	83	7.96
	310	52	104	4	1.5	325	360	18.0	2 200	3 000	7234	95.5	17
	310	52	104	4	1.5	295	325	15.6	1 900	2 500	7234B	127	17
	360	72	144	4	1.5	430	485	23.3	2 000	2 700	7334	113	35.3

1) Bearing numbers appended with the code "B" have a contact angle of 40°; bearings without this code have a contact angle of 30°.
2) Smallest allowable dimension for chamfer dimension r or r_1 .

Single and Duplex Angular Contact Ball Bearings NTN

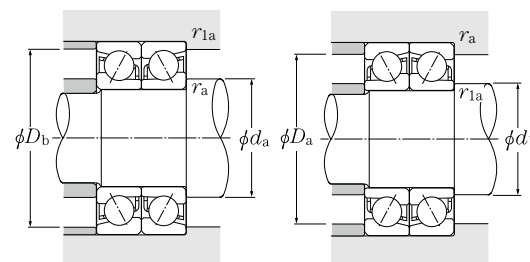

Dynamic equivalent radial load

$$P_r = XF_r + YF_a$$

Contact angle	e	Single, DT				DB, DF			
		$F_a/F_r \leq e$		$F_a/F_r > e$		$F_a/F_r \leq e$		$F_a/F_r > e$	
		X	Y	X	Y	X	Y	X	Y
30°	0.80	1	0	0.39	0.76	1	0.78	0.63	1.24
40°	1.14	1	0	0.35	0.57	1	0.55	0.57	0.93

Static equivalent radial load

$$P_{0r} = X_0 F_r + Y_0 F_a$$

Contact angle	Single, DT		DB, DF	
	X_0	Y_0	X_0	Y_0
	30°	0.5	0.33	1
40°	0.5	0.26	1	0.52

For single and DT arrangement, when $P_{0r} < F_r$ use $P_{0r} = F_r$.

Basic load rating dynamic static (duplex) kN C_r	dynamic static (duplex) kN C_{0r}	Allowable speed ¹⁾ (duplex) min ⁻¹		Bearing number	Installation-related dimensions								
		Grease lubrication	Oil lubrication			DB	DF	DT	d_a Min.	D_a Max.	mm D_b Max.	r_{as} Max.	r_{1as} Max.
169	197	2 900	3 800	DB DF DT	130	170	174.5	2	1				
330	355	2 600	3 400	DB DF DT	132	203	208	2	1				
298	325	2 300	3 000	DB DF DT	132	203	208	2	1				
445	505	2 300	3 100	DB DF DT	134	246	253	2.5	1				
405	460	2 000	2 700	DB DF DT	134	246	253	2.5	1				
135	175	2 800	3 800	DB DF DT	138.5	171.5	174.5	1.5	1				
211	251	2 600	3 500	DB DF DT	140	190	194.5	2	1				
355	395	2 400	3 100	DB DF DT	144	216	223	2.5	1				
320	360	2 100	2 700	DB DF DT	144	216	223	2.5	1				
490	585	2 100	2 800	DB DF DT	148	262	271.5	3	1.5				
450	535	1 900	2 500	DB DF DT	148	262	271.5	3	1.5				
136	180	2 600	3 500	DB DF DT	148.5	181.5	184.5	1.5	1				
215	265	2 400	3 300	DB DF DT	150	200	204.5	2	1				
365	430	2 200	2 900	DB DF DT	154	236	243	2.5	1				
330	390	1 900	2 500	DB DF DT	154	236	243	2.5	1				
540	670	2 000	2 600	DB DF DT	158	282	291.5	3	1.5				
495	615	1 700	2 300	DB DF DT	158	282	291.5	3	1.5				
175	234	2 400	3 300	DB DF DT	160	200	204.5	2	1				
246	305	2 300	3 000	DB DF DT	162	213	218	2	1				
420	515	2 000	2 700	DB DF DT	164	256	263	2.5	1				
375	470	1 800	2 400	DB DF DT	164	256	263	2.5	1				
595	765	1 800	2 400	DB DF DT	168	302	311.5	3	1.5				
540	700	1 600	2 100	DB DF DT	168	302	311.5	3	1.5				
177	241	2 300	3 000	DB DF DT	170	210	214.5	2	1				
279	355	2 100	2 800	DB DF DT	172	228	233	2	1				
475	615	1 900	2 500	DB DF DT	174	276	283	2.5	1				
430	555	1 600	2 200	DB DF DT	174	276	283	2.5	1				
625	845	1 700	2 300	DB DF DT	178	322	331.5	3	1.5				
570	770	1 500	2 000	DB DF DT	178	322	331.5	3	1.5				
183	257	2 100	2 800	DB DF DT	180	220	224.5	2	1				
335	430	2 000	2 600	DB DF DT	182	248	253	2	1				
530	715	1 800	2 400	DB DF DT	188	292	301.5	3	1.5				
480	650	1 500	2 100	DB DF DT	188	292	301.5	3	1.5				
700	970	1 600	2 100	DB DF DT	188	342	351.5	3	1.5				

Single and Duplex Angular Contact Ball Bearings

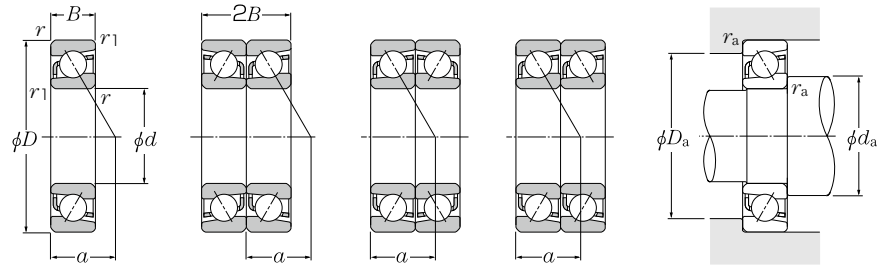

Single row Back-to-back arrangement (DB) Face-to-face arrangement (DF) Tandem arrangement (DT)

a 170 ~ 300mm

	Boundary dimensions						Basic load rating		Fatigue load limit kN C _u	Allowable speed		Bearing number ¹⁾	Load center mm a	Mass kg
	d	D	B	2B	r _{s min} ²⁾	r _{ls min} ²⁾	C _r	C _{0r}		min ⁻¹ Grease lubrication	min ⁻¹ Oil lubrication			
170	360	72	144	4	1.5	395	445	21.3	1 700	2 300	7334B	147	35.3	
180	250	33	66	2	1	145	163	7.40	2 500	3 300	7936	78.5	4.87	
	280	46	92	2.1	1.1	242	266	12.3	2 300	3 100	7036	89.5	10.4	
	320	52	104	4	1.5	340	385	18.6	2 100	2 800	7236	98	17.7	
	320	52	104	4	1.5	305	350	16.1	1 800	2 400	7236B	131	17.7	
	380	75	150	4	1.5	455	535	24.9	1 900	2 500	7336	118	40.9	
	380	75	150	4	1.5	415	490	22.8	1 600	2 100	7336B	155	40.9	
190	260	33	66	2	1	147	169	7.45	2 400	3 200	7938	81.5	5.1	
	290	46	92	2.1	1.1	248	280	12.6	2 200	2 900	7038	92.5	10.8	
	340	55	110	4	1.5	335	390	17.9	2 000	2 600	7238	104	21.3	
	340	55	110	4	1.5	300	355	15.5	1 700	2 200	7238B	139	21.3	
	400	78	156	5	2	475	585	26.6	1 800	2 300	7338	124	47	
	400	78	156	5	2	430	535	24.0	1 500	2 000	7338B	163	47	
200	280	38	76	2.1	1.1	205	231	9.90	2 200	3 000	7940	88.5	7.15	
	310	51	102	2.1	1.1	279	325	14.3	2 100	2 800	7040	99	14	
	360	58	116	4	1.5	375	450	20.2	1 900	2 500	7240	110	25.3	
	360	58	116	4	1.5	335	410	17.6	1 600	2 100	7240B	146	25.3	
	420	80	160	5	2	500	610	27.0	1 700	2 200	7340	130	53.1	
	420	80	160	5	2	455	555	24.7	1 400	1 900	7340B	170	53.1	
220	300	38	76	2.1	1.1	207	239	9.85	2 000	2 700	7944	94	7.74	
240	320	38	76	2.1	1.1	213	255	10.1	1 800	2 400	7948	100	8.34	
260	360	46	92	2.1	1.1	285	375	14.1	1 700	2 200	7952	112	14	
280	380	46	92	2.1	1.1	289	385	14.1	1 500	2 100	7956	118	14.8	
300	420	56	112	3	1.1	360	520	18.2	1 400	1 900	7960	132	23.7	

1) Bearing numbers appended with the code "B" have a contact angle of 40°; bearings without this code have a contact angle of 30°.
2) Smallest allowable dimension for chamfer dimension r or r₁.

Single and Duplex Angular Contact Ball Bearings

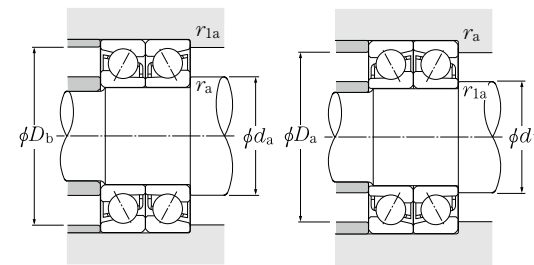

Dynamic equivalent radial load

$$P_r = XF_r + YF_a$$

Contact angle	e	Single, DT				DB, DF			
		F _a /F _r ≤ e		F _a /F _r > e		F _a /F _r ≤ e		F _a /F _r > e	
		X	Y	X	Y	X	Y	X	Y
30°	0.80	1	0	0.39	0.76	1	0.78	0.63	1.24
40°	1.14	1	0	0.35	0.57	1	0.55	0.57	0.93

Static equivalent radial load

$$P_{0r} = X_0 F_r + Y_0 F_a$$

Contact angle	Single, DT		DB, DF	
	X ₀	Y ₀	X ₀	Y ₀
30°	0.5	0.33	1	0.66
40°	0.5	0.26	1	0.52

For single and DT arrangement, when P_{0r} < F_r use P_{0r} = F_r.

Basic load rating dynamic (duplex) kN C _r	static (duplex) kN C _{0r}	Allowable speed ¹⁾ (duplex) min ⁻¹		Bearing number			Installation-related dimensions				
		Grease lubrication	Oil lubrication	DB	DF	DT	d _a Min.	D _a Max.	mm D _b Max.	r _{as} Max.	r _{1as} Max.
640	890	1 400	1 800	DB	DF	DT	188	342	351.5	3	1.5
236	325	2 000	2 700	DB	DF	DT	190	240	244.5	2	1
395	530	1 900	2 500	DB	DF	DT	192	268	273	2	1
550	770	1 700	2 200	DB	DF	DT	198	302	311.5	3	1.5
495	700	1 400	1 900	DB	DF	DT	198	302	311.5	3	1.5
735	1 070	1 500	2 000	DB	DF	DT	198	362	371.5	3	1.5
670	975	1 300	1 700	DB	DF	DT	198	362	371.5	3	1.5
239	335	1 900	2 500	DB	DF	DT	200	250	254.5	2	1
405	560	1 800	2 300	DB	DF	DT	202	278	283	2	1
545	780	1 600	2 100	DB	DF	DT	208	322	331.5	3	1.5
490	705	1 400	1 800	DB	DF	DT	208	322	331.5	3	1.5
770	1 170	1 400	1 900	DB	DF	DT	212	378	390	4	2
700	1 070	1 200	1 600	DB	DF	DT	212	378	390	4	2
335	465	1 800	2 400	DB	DF	DT	212	268	273	2	1
455	650	1 700	2 200	DB	DF	DT	212	298	303	2	1
605	900	1 500	2 000	DB	DF	DT	218	342	351.5	3	1.5
545	815	1 300	1 700	DB	DF	DT	218	342	351.5	3	1.5
810	1 220	1 300	1 800	DB	DF	DT	222	398	410	4	2
740	1 110	1 200	1 500	DB	DF	DT	222	398	410	4	2
335	475	1 600	2 100	DB	DF	DT	232	288	293	2	1
345	510	1 500	1 900	DB	DF	DT	252	308	313	2	1
465	750	1 300	1 800	DB	DF	DT	272	348	353	2	1
470	775	1 200	1 600	DB	DF	DT	292	368	373	2	1
590	1 040	1 100	1 500	DB	DF	DT	314	406	413	2.5	1

Four-Point Contact Ball Bearings

NTN

QJ type

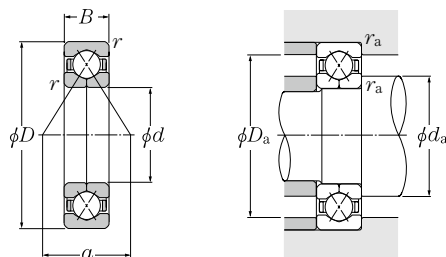

Dynamic equivalent axial load
 $P_a = F_a$
 Static equivalent axial load
 $P_{0a} = F_a$

d 30 ~ 90mm

Boundary dimensions	mm			Basic load rating		Fatigue load limit kN C_u	Allowable speed		Bearing number	Installation-related dimensions			Load center mm a	Mass kg (approx.)
	d	D	B	$r_{s \min}^{1)}$	dynamic C_a		static C_{0a}	Grease lubrication		Oil lubrication	d_a Min.	D_a Max.		
30	72	19	1.1	44.0	57.5	2.46	8 000	11 000	QJ306	37	65	1	30	0.42
35	80	21	1.5	55.0	73.0	3.15	7 000	9 300	QJ307	43.5	71.5	1.5	33	0.57
40	80	18	1.1	49.0	70.5	3.05	6 900	9 200	QJ208	47	73	1	34.5	0.45
	90	23	1.5	67.0	91.5	3.95	6 200	8 200	QJ308	48.5	81.5	1.5	37.5	0.78
45	85	19	1.1	55.0	81.0	3.50	6 200	8 200	QJ209	52	78	1	37.5	0.52
	100	25	1.5	87.0	121	5.20	5 500	7 400	QJ309	53.5	91.5	1.5	42	1.05
50	90	20	1.1	57.5	89.0	3.80	5 600	7 500	QJ210	57	83	1	40.5	0.603
	110	27	2	102	145	6.20	5 000	6 700	QJ310	60	100	2	46	1.38
55	100	21	1.5	71.0	112	4.80	5 100	6 800	QJ211	63.5	91.5	1.5	44.5	0.78
	120	29	2	118	170	7.30	4 600	6 100	QJ311	65	110	2	50.5	1.76
60	110	22	1.5	86.0	138	5.90	4 700	6 300	QJ212	68.5	101.5	1.5	49	0.98
	130	31	2.1	135	198	8.50	4 200	5 700	QJ312	72	118	2	55	2.18
65	120	23	1.5	93.5	153	6.55	4 400	5 800	QJ213	73.5	111.5	1.5	53.5	1.24
	140	33	2.1	153	228	9.70	3 900	5 200	QJ313	77	128	2	59	2.7
70	125	24	1.5	102	168	7.15	4 000	5 400	QJ214	78.5	116.5	1.5	56.5	1.36
	150	35	2.1	172	260	10.7	3 600	4 800	QJ314	82	138	2	63.5	3.27
75	130	25	1.5	106	183	7.55	3 800	5 000	QJ215	83.5	121.5	1.5	59	1.53
	160	37	2.1	187	294	11.7	3 400	4 500	QJ315	87	148	2	68	3.9
80	140	26	2	124	217	8.65	3 500	4 700	QJ216	90	130	2	63.5	1.83
	170	39	2.1	202	330	12.7	3 200	4 200	QJ316	92	158	2	72	4.64
85	150	28	2	139	252	9.65	3 300	4 400	QJ217	95	140	2	68	2.3
	180	41	3	218	370	13.8	3 000	4 000	QJ317	99	166	2.5	76.5	5.43
90	160	30	2	164	293	11.1	3 100	4 200	QJ218	100	150	2	72	2.76
	190	43	3	235	410	14.8	2 800	3 800	QJ318	104	176	2.5	81	6.31

1) Smallest allowable dimension for chamfer dimension r .

Note: 1. These bearings are also manufactured with a slot in the chamfer section of the outer ring to stop whirling.

2. This bearing is widely used in applications where the only type of load is axial. When considering it for use where radial loads are applied, consult NTN Engineering.

Four-Point Contact Ball Bearings

NTN

QJ type

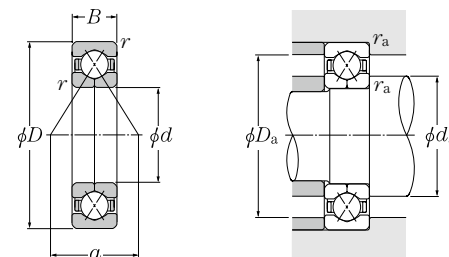

Dynamic equivalent axial load
 $P_a = F_a$
 Static equivalent axial load
 $P_{0a} = F_a$

d 95 ~ 120mm

Boundary dimensions	mm			Basic load rating		Fatigue load limit kN C_u	Allowable speed		Bearing number	Installation-related dimensions			Load center mm a	Mass kg (approx.)
	d	D	B	$r_{s \min}^{1)}$	dynamic C_a		static C_{0a}	Grease lubrication		Oil lubrication	d_a Min.	D_a Max.		
95	170	32	2.1	186	335	12.4	3 000	3 900	QJ219	107	158	2	76.5	3.35
	200	45	3	251	450	16.0	2 700	3 500	QJ319	109	186	2.5	85	7.41
100	180	34	2.1	200	355	12.9	2 800	3 700	QJ220	112	168	2	81	4.02
	215	47	3	302	585	20.0	2 500	3 400	QJ320	114	201	2.5	91	9.14
105	190	36	2.1	218	400	14.2	2 700	3 600	QJ221	117	178	2	85	4.75
	225	49	3	303	585	19.6	2 400	3 200	QJ321	119	211	2.5	95.5	10.4
110	200	38	2.1	236	450	15.5	2 500	3 400	QJ222	122	188	2	89.5	5.62
	240	50	3	338	680	22.1	2 300	3 100	QJ322	124	226	2.5	101	12
120	215	40	2.1	266	540	17.7	2 300	3 100	QJ224	132	203	2	96.5	6.75
	260	55	3	359	765	23.8	2 100	2 800	QJ324	134	246	2.5	110	15.9

1) Smallest allowable dimension for chamfer dimension r .

Note: 1. These bearings are also manufactured with a slot in the chamfer section of the outer ring to stop whirling.

2. This bearing is widely used in applications where the only type of load is axial. When considering it for use where radial loads are applied, consult NTN Engineering.

● Double Row Angular Contact Ball Bearings

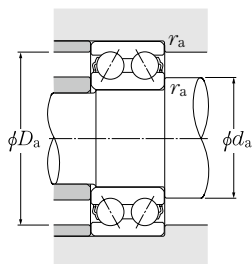
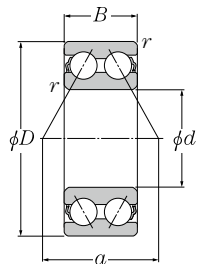

Dynamic equivalent radial load
 $P_r = XF_r + YF_a$

e	$\frac{F_a}{F_r} \leq e$		$\frac{F_a}{F_r} > e$	
	X	Y	X	Y
0.68	1	0.92	0.67	1.41

Static equivalent radial load
 $P_{0r} = F_r + 0.76F_a$

d 10 ~ 65mm

	Boundary dimensions			Basic load rating		Fatigue load limit kN C_u	Allowable speed		Bearing number	Installation-related dimensions			Load center mm a	Mass kg (approx.)
	mm	mm	mm	dynamic kN	static kN		min ⁻¹	Oil lubrication		mm	mm	mm		
d	D	B	$r_{s \min}^{1)}$	C_r	C_{0r}		Grease lubrication		d_a Min.	D_a Max.	r_{as} Max.			
10	30	14.3	0.6	7.15	3.90	0.230	17 000	22 000	5200S	15	25	0.6	14.5	0.05
12	32	15.9	0.6	10.5	5.80	0.350	15 000	20 000	5201S	17	27	0.6	16.7	0.06
15	35	15.9	0.6	11.7	7.05	0.420	13 000	17 000	5202S	20	30	0.6	18.3	0.07
	42	19	1	17.6	10.2	0.620	11 000	15 000	5302S	21	36	1	22	0.13
17	40	17.5	0.6	14.6	9.05	0.540	11 000	15 000	5203S	22	35	0.6	20.8	0.1
	47	22.2	1	21.0	12.6	0.770	10 000	13 000	5303S	23	41	1	25	0.18
20	47	20.6	1	19.6	12.4	0.750	10 000	13 000	5204S	26	41	1	24.3	0.16
	52	22.2	1.1	24.6	15.0	0.930	9 000	12 000	5304S	27	45	1	26.7	0.22
25	52	20.6	1	21.3	14.7	0.880	8 500	11 000	5205S	31	46	1	26.8	0.18
	62	25.4	1.1	32.5	20.7	1.30	7 500	10 000	5305S	32	55	1	31.8	0.35
30	62	23.8	1	29.6	21.1	1.30	7 100	9 500	5206S	36	56	1	31.6	0.3
	72	30.2	1.1	40.5	28.1	1.70	6 300	8 500	5306S	37	65	1	36.5	0.57
35	72	27	1.1	39.0	28.7	1.70	6 300	8 000	5207S	42	65	1	36.6	0.46
	80	34.9	1.5	51.0	36.0	2.20	5 600	7 500	5307S	44	71	1.5	41.6	0.76
40	80	30.2	1.1	44.0	33.5	2.00	5 600	7 100	5208S	47	73	1	41.5	0.62
	90	36.5	1.5	56.5	41.0	2.50	5 300	6 700	5308S	49	81	1.5	45.5	1.03
45	85	30.2	1.1	49.5	38.0	2.30	5 000	6 700	5209S	52	78	1	43.4	0.67
	100	39.7	1.5	68.5	51.0	3.10	4 500	6 000	5309S	54	91	1.5	50.6	1.37
50	90	30.2	1.1	53.0	43.5	2.70	4 800	6 000	5210S	57	83	1	45.9	0.72
	110	44.4	2	81.5	61.5	3.80	4 300	5 600	5310S	60	100	2	55.6	1.84
55	100	33.3	1.5	56.0	49.0	3.00	4 300	5 600	5211S	64	91	1.5	50.1	1.01
	120	49.2	2	95.0	73.0	4.50	3 800	5 000	5311S	65	110	2	60.6	2.4
60	110	36.5	1.5	69.0	62.0	3.80	3 800	5 000	5212S	69	101	1.5	56.5	1.33
	130	54	2.1	125	98.5	6.00	3 400	4 500	5312S	72	118	2	69.2	2.92
65	120	38.1	1.5	76.5	69.0	4.20	3 600	4 500	5213S	74	111	1.5	59.7	1.71
	140	58.7	2.1	142	113	7.00	3 200	4 300	5313S	77	128	2	72.8	3.67

1) Smallest allowable dimension for chamfer dimension r.

● Double Row Angular Contact Ball Bearings

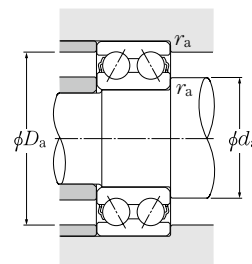
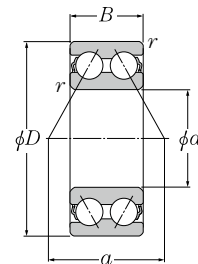

Dynamic equivalent radial load
 $P_r = XF_r + YF_a$

e	$\frac{F_a}{F_r} \leq e$		$\frac{F_a}{F_r} > e$	
	X	Y	X	Y
0.68	1	0.92	0.67	1.41

Static equivalent radial load
 $P_{0r} = F_r + 0.76F_a$

d 70 ~ 85mm

	Boundary dimensions			Basic load rating		Fatigue load limit kN C_u	Allowable speed		Bearing number	Installation-related dimensions			Load center mm a	Mass kg (approx.)
	mm	mm	mm	dynamic kN	static kN		min ⁻¹	Oil lubrication		mm	mm	mm		
d	D	B	$r_{s \min}^{1)}$	C_r	C_{0r}		Grease lubrication		d_a Min.	D_a Max.	r_{as} Max.			
70	125	39.7	1.5	94.0	82.0	5.00	3 400	4 500	5214S	79	116	1.5	63.8	1.75
	150	63.5	2.1	159	128	7.90	3 000	3 800	5314S	82	138	2	78.3	4.55
75	130	41.3	1.5	93.5	83.0	5.10	3 200	4 300	5215S	84	121	1.5	66.1	1.88
80	140	44.4	2	99.0	93.0	5.70	3 000	3 800	5216S	90	130	2	69.6	2.51
85	150	49.2	2	116	110	6.70	2 800	3 600	5217S	95	140	2	75.3	3.16

1) Smallest allowable dimension for chamfer dimension r.

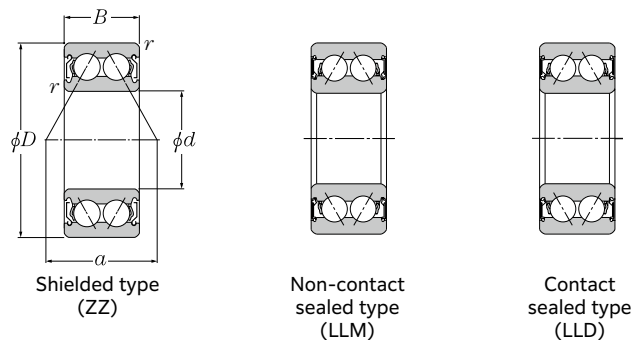

a 10 ~ 40mm

Boundary dimensions	Basic load rating		Fatigue load limit kN C_{10}	Allowable speed			Bearing number ²⁾					
	mm			dynamic kN C_r	static kN C_{0r}	Fatigue load limit kN C_{10}	Grease lubrication ZZ, LLM Z, LM	Oil lubrication Z, LM	LLD, LD	Shielded type	Non-contact sealed type	Contact sealed type
10	30	14.3	0.6	7.15	3.90	0.230	17 000	22 000	15 000	5200SCZZ	LLM	LLD
12	32	15.9	0.6	8.50	5.30	0.310	15 000	20 000	12 000	5201SCZZ	LLM	LLD
15	35	15.9	0.6	8.50	5.30	0.310	13 000	17 000	12 000	5202SCZZ	LLM	LLD
17	40	17.5	0.6	12.7	8.30	0.490	11 000	15 000	10 000	5203SCZZ	LLM	LLD
	47	22.2	1	19.6	12.4	0.750	10 000	13 000	9 500	5303SCZZ	LLM	LLD
20	47	20.6	1	15.9	10.7	0.640	10 000	13 000	9 000	5204SCZZ	LLM	LLD
25	52	20.6	1	16.9	12.3	0.740	8 500	11 000	7 500	5205SCZZ ³⁾	LLM	LLD
	62	25.4	1.1	25.2	18.2	1.10	7 500	10 000	6 300	5305SCZZ	LLM	LLD
30	62	23.8	1	25.2	18.2	1.10	7 100	9 500	6 300	5206SCZZ	LLM	LLD
	72	30.2	1.1	39.0	28.7	1.70	6 300	8 500	5 300	5306SCZZ	LLM	LLD
35	72	27.0	1.1	34.0	25.3	1.50	6 300	8 500	5 300	5207SCZZ	LLM	LLD
	80	34.9	1.5	44.0	33.5	2.00	5 600	7 500	4 800	5307SCZZ	LLM	LLD
40	80	30.2	1.1	36.5	29.0	1.70	5 600	7 100	4 800	5208SCZZ ³⁾	LLM	LLD
	90	36.5	1.5	49.5	38.0	2.30	5 300	6 700	4 500	5308SCZZ	LLM	LLD

1) Smallest allowable dimension for chamfer dimension r.
 2) This bearing number is for double sealed and double shielded type bearings, but single sealed and single shielded types are also available.
 3) Resin formed cage is standard for 5205SC and 5208SC.

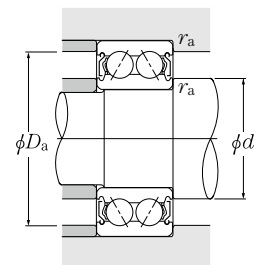

Dynamic equivalent radial load
 $P_r = XF_r + YF_a$

e	$\frac{F_a}{F_r} \leq e$		$\frac{F_a}{F_r} > e$	
	X	Y	X	Y
0.68	1	0.92	0.67	1.41

Static equivalent radial load
 $P_{0r} = F_r + 0.76F_a$

Installation-related dimensions				Load center
mm				mm
Min.	Max.	Max.	Max.	a
14	15.5	26	0.6	14.5
16	19	28	0.6	16.3
19	19	31	0.6	16.3
21	23.5	36	0.6	20.1
23	25.5	41	1	24.3
26	26.5	41	1	23
31	32	46	1	25.4
32	38.5	55	1	30.9
36	38.5	56	1	30.9
37	44.5	65	1	36.6
42	45	65	1	36.3
44	50.5	71	1.5	41.5
47	50.5	73	1	39.4
49	53	81	1.5	43

Self-Aligning Ball Bearings



1. Design features and characteristics

The outer ring raceway of self-aligning ball bearings forms a spherical surface whose center is common to the bearing center. The inner ring of the bearing has two raceways.

The balls, cage, and inner ring of these bearings are capable of shifting in order to compensate for a certain degree of misalignment with the outer rings. As a result, the bearing is able to align itself and compensate for shaft / housing finishing unevenness, bearing fitting error, and other sources of misalignment as shown in **Fig. 1**.

Since axial load capacity is limited, self-aligning ball bearings are not suitable for applications with heavy axial loads.

It is recommended to use an adapter on a self-aligning ball bearing with a tapered bore inner diameter for ease of installation and disassembly. These bearings and adapters are often used on drive shaft applications.

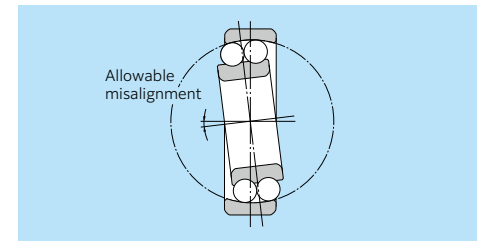





Fig. 1

2. Standard cage type

All bearing series are equipped with a pressed cage, except 2321S and 2322S, which are equipped with a machined cage.

Table 1 Standard cage types of spherical ball bearings

Cage type	Pressed steel cage		Machined cage
			
Bearing series or model	12 and 13 series	22 and 23 series	2321S, 2322S

3. Ball protrusion

Bearings with part numbers listed in **Table 2** below have balls which protrude slightly from the bearing face as illustrated in **Fig. 2**. The total width dimensions are shown in **Table 2**.

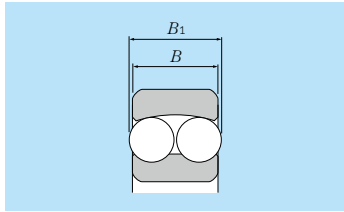

Fig. 2

Table 2 Unit: mm

Bearing numbers	Width dimension B	Total width dimension B_1
2222S (K)	53	54
2316S (K)	58	59
2319S (K)	67	68
2320S (K)	73	74
2321S	77	78
2322S (K)	80	81
1318S (K)	43	46
1319S (K)	45	49
1320S (K)	47	53
1321S	49	55
1322S (K)	50	56

4. Allowable misalignment angle

The allowable misalignment angle can be determined by the following function. This degree of allowable misalignment may be limited by the design of mating components around the bearing.

Normal load 1/15

5. Precautions for using self-aligning ball bearings

Self-aligning ball bearings are unable to support large axial loads and therefore axial loading shall be limited.

Please consider using self-aligning roller bearings when a large axial load is to be applied.

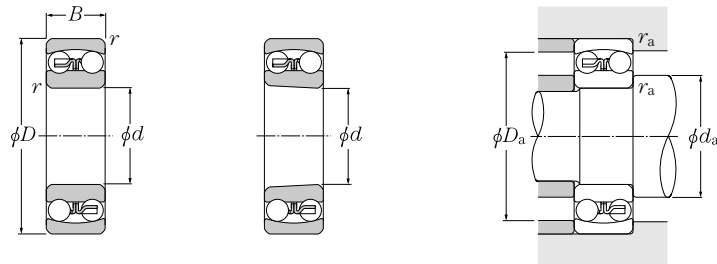

Cylindrical bore

Tapered bore

d 10 ~ 35mm

	Boundary dimensions			Basic load rating		Fatigue load limit kN C _u	Allowable speed		Bearing numbers		Installation-related dimensions		
	mm	mm	mm	dynamic kN	static kN		Grease lubrication	Oil lubrication	Cylindrical bore	Tapered bore ²⁾	d _a mm Min.	D _a mm Max.	r _{as} mm Max.
10	30	9	0.6	5.55	1.19	0.049	22 000	28 000	1200S	—	14.0	26.0	0.6
	30	14	0.6	7.45	1.59	0.067	24 000	28 000	2200S	—	14.0	26.0	0.6
	35	11	0.6	7.35	1.62	0.074	20 000	24 000	1300S	—	14.0	31.0	0.6
	35	17	0.6	9.20	2.01	0.096	18 000	22 000	2300S	—	14.0	31.0	0.6
12	32	10	0.6	5.70	1.27	0.053	22 000	26 000	1201S	—	16.0	28.0	0.6
	32	14	0.6	7.75	1.73	0.089	22 000	26 000	2201S	—	16.0	28.0	0.6
	37	12	1	9.65	2.16	0.078	18 000	22 000	1301S	—	17.0	32.0	1
	37	17	1	12.1	2.73	0.120	17 000	22 000	2301S	—	17.0	32.0	1
15	35	11	0.6	7.60	1.75	0.072	18 000	22 000	1202S	—	19.0	31.0	0.6
	35	14	0.6	7.80	1.85	0.095	18 000	22 000	2202S	—	19.0	31.0	0.6
	42	13	1	9.70	2.29	0.081	16 000	20 000	1302S	—	20.0	37.0	1
	42	17	1	12.3	2.91	0.130	14 000	18 000	2302S	—	20.0	37.0	1
17	40	12	0.6	8.00	2.01	0.083	16 000	20 000	1203S	—	21.0	36.0	0.6
	40	16	0.6	9.95	2.42	0.130	16 000	20 000	2203S	—	21.0	36.0	0.6
	47	14	1	12.7	3.20	0.110	14 000	17 000	1303S	—	22.0	42.0	1
	47	19	1	14.7	3.55	0.160	13 000	16 000	2303S	—	22.0	42.0	1
20	47	14	1	10.0	2.61	0.110	14 000	17 000	1204S	1204SK	25.0	42.0	1
	47	18	1	12.8	3.30	0.140	14 000	17 000	2204S	2204SK	25.0	42.0	1
	52	15	1.1	12.6	3.35	0.140	12 000	15 000	1304S	1304SK	26.5	45.5	1
	52	21	1.1	18.5	4.70	0.210	11 000	14 000	2304S	2304SK	26.5	45.5	1
25	52	15	1	12.2	3.30	0.130	12 000	14 000	1205S	1205SK	30.0	47.0	1
	52	18	1	12.4	3.45	0.200	12 000	14 000	2205S	2205SK	30.0	47.0	1
	62	17	1.1	18.2	5.00	0.150	10 000	13 000	1305S	1305SK	31.5	55.5	1
	62	24	1.1	24.9	6.60	0.290	9 500	12 000	2305S	2305SK	31.5	55.5	1
30	62	16	1	15.8	4.65	0.190	10 000	12 000	1206S	1206SK	35.0	57.0	1
	62	20	1	15.3	4.55	0.260	10 000	12 000	2206S	2206SK	35.0	57.0	1
	72	19	1.1	21.4	6.30	0.190	8 500	11 000	1306S	1306SK	36.5	65.5	1
	72	27	1.1	32.0	8.75	0.380	8 000	10 000	2306S	2306SK	36.5	65.5	1
35	72	17	1.1	15.9	5.10	0.210	8 500	10 000	1207S	1207SK	41.5	65.5	1
	72	23	1.1	21.7	6.60	0.320	8 500	10 000	2207S	2207SK	41.5	65.5	1
	80	21	1.5	25.3	7.85	0.280	7 500	9 500	1307S	1307SK	43.0	72.0	1.5
	80	31	1.5	40.0	11.3	0.480	7 100	9 000	2307S	2307SK	43.0	72.0	1.5

1) Smallest allowable dimension for chamfer dimension r. 2) "K" indicates bearings having a tapered bore with a taper ratio of 1:12

Dynamic equivalent radial load

$$P_r = X F_r + Y F_a$$

$\frac{F_a}{F_r} \leq e$		$\frac{F_a}{F_r} > e$	
X	Y	X	Y
1	Y ₁	0.65	Y ₂

Static equivalent radial load

$$P_{0r} = F_r + Y_0 F_a$$

For values of e, Y₁, Y₂ and Y₀ see the table below.

Constant	Axial load factors			Mass kg (approx.)
	e	Y ₁	Y ₂	
				Y ₀
0.32	2.00	3.10	2.10	0.034
0.64	0.98	1.50	1.00	0.046
0.35	1.80	2.80	1.90	0.059
0.71	0.89	1.40	0.93	0.078
0.36	1.80	2.70	1.80	0.041
0.58	1.10	1.70	1.10	0.051
0.33	1.90	2.90	2.00	0.068
0.60	1.10	1.60	1.10	0.087
0.32	2.00	3.10	2.10	0.050
0.50	1.30	1.90	1.30	0.058
0.33	1.90	2.90	2.00	0.101
0.51	1.20	1.90	1.30	0.113
0.31	2.00	3.10	2.10	0.074
0.50	1.30	1.90	1.30	0.089
0.32	2.00	3.10	2.10	0.130
0.51	1.20	1.90	1.30	0.160
0.29	2.20	3.40	2.30	0.120
0.47	1.30	2.10	1.40	0.142
0.29	2.20	3.40	2.30	0.164
0.50	1.20	1.90	1.30	0.207
0.28	2.30	3.50	2.40	0.140
0.41	1.50	2.40	1.60	0.160
0.28	2.30	3.50	2.40	0.261
0.47	1.40	2.10	1.40	0.332
0.25	2.50	3.90	2.60	0.220
0.38	1.60	2.50	1.70	0.262
0.26	2.40	3.70	2.50	0.391
0.44	1.40	2.20	1.50	0.500
0.23	2.70	4.20	2.80	0.330
0.37	1.70	2.60	1.80	0.403
0.26	2.50	3.80	2.60	0.520
0.46	1.40	2.10	1.40	0.671

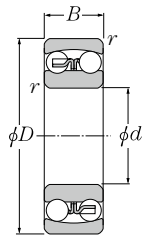

Cylindrical bore

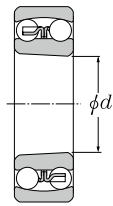

Tapered bore

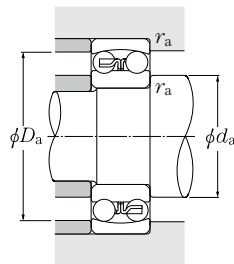

Dynamic equivalent radial load

$$P_r = X F_r + Y F_a$$

$\frac{F_a}{F_r} \leq e$		$\frac{F_a}{F_r} > e$	
X	Y	X	Y
1	Y ₁	0.65	Y ₂

Static equivalent radial load

$$P_{0r} = F_r + Y_0 F_a$$

For values of e , Y_1 , Y_2 and Y_0 see the table below.

d 40 ~ 75mm

	Boundary dimensions			Basic load rating		Fatigue load limit	Allowable speed		Bearing numbers		Installation-related dimensions			
	mm	mm	mm	dynamic kN	static kN		Grease lubrication	Oil lubrication	Cylindrical bore	Tapered bore ²⁾	mm	mm	mm	
	d	D	B	$r_{s \min}^{1)}$	C_r	C_{0r}	C_u					d_a Min.	D_a Max.	r_{as} Max.
40	80	18	1.1	19.3	6.50	0.260	7 500	9 000	1208S	1208SK	46.5	73.5	1	
	80	23	1.1	22.4	7.35	0.390	7 500	9 000	2208S	2208SK	46.5	73.5	1	
	90	23	1.5	29.8	9.70	0.300	6 700	8 500	1308S	1308SK	48.0	82.0	1.5	
	90	33	1.5	45.5	13.5	0.580	6 300	8 000	2308S	2308SK	48.0	82.0	1.5	
45	85	19	1.1	22.0	7.35	0.290	7 100	8 500	1209S	1209SK	51.5	78.5	1	
	85	23	1.1	23.3	8.15	0.510	7 100	8 500	2209S	2209SK	51.5	78.5	1	
	100	25	1.5	38.5	12.7	0.330	6 000	7 500	1309S	1309SK	53.0	92.0	1.5	
	100	36	1.5	55.0	16.7	0.710	5 600	7 100	2309S	2309SK	53.0	92.0	1.5	
50	90	20	1.1	22.8	8.10	0.330	6 300	8 000	1210S	1210SK	56.5	83.5	1	
	90	23	1.1	23.3	8.45	0.570	6 300	8 000	2210S	2210SK	56.5	83.5	1	
	110	27	2	43.5	14.1	0.350	5 600	6 700	1310S	1310SK	59.0	101	2	
	110	40	2	65.0	20.2	0.860	5 000	6 300	2310S	2310SK	59.0	101	2	
55	100	21	1.5	26.9	10.0	0.400	6 000	7 100	1211S	1211SK	63.0	92.0	1.5	
	100	25	1.5	26.7	9.90	0.720	6 000	7 100	2211S	2211SK	63.0	92.0	1.5	
	120	29	2	51.5	17.9	0.400	5 000	6 300	1311S	1311SK	64.0	111	2	
	120	43	2	76.5	24.0	1.00	4 800	6 000	2311S	2311SK	64.0	111	2	
60	110	22	1.5	30.5	11.5	0.460	5 300	6 300	1212S	1212SK	68.0	102	1.5	
	110	28	1.5	34.0	12.6	0.840	5 300	6 300	2212S	2212SK	68.0	102	1.5	
	130	31	2.1	57.5	20.8	0.510	4 500	5 600	1312S	1312SK	71.0	119	2	
	130	46	2.1	88.5	28.3	1.20	4 300	5 300	2312S	2312SK	71.0	119	2	
65	120	23	1.5	31.0	12.5	0.500	4 800	6 000	1213S	1213SK	73.0	112	1.5	
	120	31	1.5	43.5	16.4	0.920	4 800	6 000	2213S	2213SK	73.0	112	1.5	
	140	33	2.1	62.5	22.9	0.670	4 300	5 300	1313S	1313SK	76.0	129	2	
	140	48	2.1	97.0	32.5	1.40	3 800	4 800	2313S	2313SK	76.0	129	2	
70	125	24	1.5	35.0	13.8	0.550	4 800	5 600	1214S	—	78.0	117	1.5	
	125	31	1.5	44.0	17.1	1.10	4 500	5 600	2214S	—	78.0	117	1.5	
	150	35	2.1	75.0	27.7	0.690	4 000	5 000	1314S	—	81.0	139	2	
	150	51	2.1	111	37.5	1.60	3 600	4 500	2314S	—	81.0	139	2	
75	130	25	1.5	39.0	15.7	0.630	4 300	5 300	1215S	1215SK	83.0	122	1.5	
	130	31	1.5	44.5	17.8	1.20	4 300	5 300	2215S	2215SK	83.0	122	1.5	
	160	37	2.1	80.0	30.0	0.720	3 800	4 500	1315S	1315SK	86.0	149	2	
	160	55	2.1	125	43.0	1.80	3 400	4 300	2315S	2315SK	86.0	149	2	

1) Smallest allowable dimension for chamfer dimension r . 2) "K" indicates bearings having a tapered bore with a taper ratio of 1:12

Constant	Axial load factors			Mass (approx.) kg
	e	Y_1	Y_2	
0.22	2.8	4.3	2.9	0.420
0.33	1.9	3.0	2.0	0.506
0.24	2.6	4.0	2.7	0.727
0.43	1.5	2.3	1.5	0.918
0.21	3.0	4.7	3.1	0.470
0.30	2.1	3.2	2.2	0.556
0.25	2.6	4.0	2.7	0.971
0.41	1.5	2.4	1.6	1.200
0.21	3.1	4.7	3.2	0.535
0.28	2.2	3.4	2.3	0.598
0.23	2.7	4.2	2.8	1.230
0.42	1.5	2.3	1.6	1.630
0.20	3.2	4.9	3.3	0.708
0.28	2.3	3.5	2.4	0.807
0.23	2.7	4.2	2.8	1.600
0.41	1.5	2.4	1.6	2.080
0.18	3.4	5.3	3.6	0.910
0.28	2.3	3.5	2.4	1.100
0.23	2.8	4.3	2.9	2.000
0.40	1.6	2.4	1.6	2.580
0.17	3.7	5.7	3.8	1.160
0.28	2.3	3.5	2.4	1.500
0.23	2.7	4.2	2.9	2.470
0.39	1.6	2.5	1.7	3.200
0.18	3.4	5.3	3.6	1.300
0.26	2.4	3.7	2.5	1.550
0.22	2.8	4.4	3.0	3.030
0.38	1.7	2.6	1.8	3.900
0.17	3.6	5.6	3.8	1.360
0.25	2.5	3.9	2.6	1.600
0.22	2.8	4.4	2.9	3.630
0.38	1.6	2.5	1.7	4.780

Self-Aligning Ball Bearings

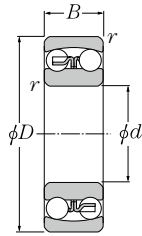

Cylindrical bore

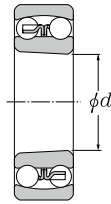

Tapered bore

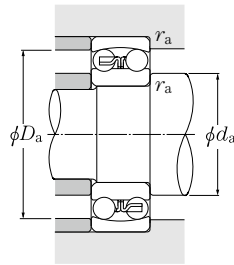

Self-Aligning Ball Bearings



Dynamic equivalent radial load

$$P_r = X F_r + Y F_a$$

$\frac{F_a}{F_r} \leq e$		$\frac{F_a}{F_r} > e$	
X	Y	X	Y
1	Y ₁	0.65	Y ₂

Static equivalent radial load

$$P_{0r} = F_r + Y_0 F_a$$

For values of e , Y_1 , Y_2 and Y_0 see the table below.

d 80 ~ 110mm

	Boundary dimensions			Basic load rating		Fatigue load limit kN C_u	Allowable speed		Bearing numbers		Installation-related dimensions		
	mm			dynamic	static		min ⁻¹		Cylindrical bore	Tapered bore ²⁾	mm		
	d	D	B	C_r	C_{0r}		Grease lubrication	Oil lubrication			d_a	D_a	r_{as}
80	140	26	2	40.0	17.0	0.680	4 000	5 000	1216S	1216SK	89	131	2
	140	33	2	49.0	19.9	1.30	4 000	5 000	2216S	2216SK	89	131	2
	170	39	2.1	89.0	33.0	0.800	3 600	4 300	1316S	1316SK	91	159	2
	170	58	2.1	130	45.0	1.90	3 200	4 000	2316S	2316SK	91	159	2
85	150	28	2	49.5	20.8	0.830	3 800	4 500	1217S	1217SK	94	141	2
	150	36	2	58.5	23.6	1.50	3 800	4 800	2217S	2217SK	94	141	2
	180	41	3	98.5	38.0	0.950	3 400	4 000	1317S	1317SK	98	167	2.5
	180	60	3	142	51.5	2.10	3 000	3 800	2317S	2317SK	98	167	2.5
90	160	30	2	57.5	23.5	0.940	3 600	4 300	1218S	1218SK	99	151	2
	160	40	2	70.5	28.7	1.80	3 600	4 300	2218S	2218SK	99	151	2
	190	43	3	117	44.5	1.20	3 200	3 800	1318S	1318SK	103	177	2.5
	190	64	3	154	57.5	2.40	2 800	3 600	2318S	2318SK	103	177	2.5
95	170	32	2.1	64.0	27.1	1.10	3 400	4 000	1219S	1219SK	106	159	2
	170	43	2.1	84.0	34.5	2.00	3 400	4 000	2219S	2219SK	106	159	2
	200	45	3	129	51.0	1.40	3 000	3 600	1319S	1319SK	108	187	2.5
	200	67	3	161	64.5	2.70	2 800	3 400	2319S	2319SK	108	187	2.5
100	180	34	2.1	69.5	29.7	1.20	3 200	3 800	1220S	1220SK	111	169	2
	180	46	2.1	94.5	38.5	2.30	3 200	3 800	2220S	2220SK	111	169	2
	215	47	3	140	57.5	1.60	2 800	3 400	1320S	1320SK	113	202	2.5
	215	73	3	187	79.0	3.30	2 400	3 200	2320S	2320SK	113	202	2.5
105	190	36	2.1	75.0	32.5	1.30	3 000	3 600	1221S	—	116	179	2
	190	50	2.1	109	45.0	2.60	3 000	3 600	2221S	—	116	179	2
	225	49	3	154	64.5	1.80	2 600	3 200	1321S	—	118	212	2.5
	225	77	3	200	87.0	3.60	2 400	3 000	2321S³⁾	—	118	212	2.5
110	200	38	2.1	87.0	38.5	1.50	2 800	3 400	1222S	1222SK	121	189	2
	200	53	2.1	122	51.5	2.90	2 800	3 400	2222S	2222SK	121	189	2
	240	50	3	161	72.5	2.10	2 400	3 000	1322S	1322SK	123	227	2.5
	240	80	3	211	94.5	3.90	2 200	2 800	2322S³⁾	2322SK	123	227	2.5

Constant	Axial load factors			Mass kg (approx.)
	e	Y_1	Y_2	
0.16	3.9	6.0	4.1	1.68
0.25	2.5	3.9	2.7	2.02
0.22	2.9	4.5	3.1	4.24
0.39	1.6	2.5	1.7	5.63
0.17	3.7	5.7	3.8	2.10
0.25	2.5	3.9	2.6	2.56
0.21	2.9	4.6	3.1	5.03
0.37	1.7	2.6	1.8	6.56
0.17	3.8	5.8	3.9	2.56
0.27	2.4	3.7	2.5	3.22
0.22	2.8	4.3	2.9	5.83
0.38	1.7	2.6	1.7	7.75
0.17	3.7	5.8	3.9	3.12
0.27	2.4	3.7	2.5	3.96
0.23	2.8	4.3	2.9	6.79
0.38	1.7	2.6	1.8	8.97
0.17	3.6	5.6	3.8	3.74
0.27	2.4	3.7	2.5	4.71
0.24	2.7	4.1	2.8	8.40
0.38	1.7	2.6	1.8	11.5
0.18	3.6	5.5	3.7	4.43
0.28	2.3	3.5	2.4	5.73
0.23	2.7	4.2	2.9	9.58
0.38	1.7	2.6	1.7	14.5
0.18	3.7	5.7	3.9	5.21
0.28	2.2	3.5	2.3	6.75
0.22	2.8	4.4	3.0	11.5
0.37	1.7	2.6	1.8	17.5

1) Smallest allowable dimension for chamfer dimension r . 2) "K" indicates bearings having a tapered bore with a taper ratio of 1:12. 3) A machined cage is the standard for 2321S and 2322S(K).

(For self-aligning ball bearings)

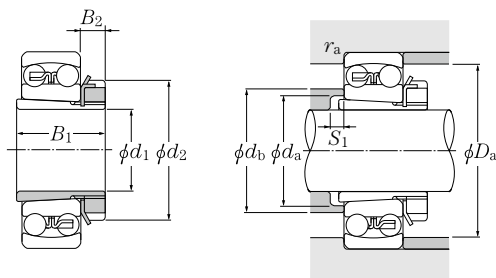

d 17 ~ 50mm

	Boundary dimensions				Numbers		Installation-related dimensions					Mass ¹⁾
	mm				Bearing	Adapter	d_a	d_b	mm	D_a	r_{as}	kg
	d_1	B_1	d_2	B_2			Min.	Max.	S_1 Min.	Max.	Max.	(approx.)
17	24	32	7		1204SK; H 204		23	27	5	41	1	0.041
	28	32	7		2204SK; H 304		24	28	5	41	1	0.045
	28	32	7		1304SK; H 304		24	31	8	45	1	0.045
	31	32	7		2304SK; H2304		24	28	5	45	1	0.049
20	26	38	8		1205SK; H 205X		28	33	5	46	1	0.07
	29	38	8		2205SK; H 305X		29	33	5	46	1	0.075
	29	38	8		1305SK; H 305X		29	37	6	55	1	0.075
	35	38	8		2305SK; H2305X		29	34	5	55	1	0.087
25	27	45	8		1206SK; H 206X		33	39	5	56	1	0.099
	31	45	8		2206SK; H 306X		34	39	5	56	1	0.109
	31	45	8		1306SK; H 306X		34	44	6	65	1	0.109
	38	45	8		2306SK; H2306X		35	40	5	65	1	0.126
30	29	52	9		1207SK; H 207X		38	46	5	65	1	0.125
	35	52	9		2207SK; H 307X		39	45	5	65	1	0.142
	35	52	9		1307SK; H 307X		39	50	7	71.5	1.5	0.142
	43	52	9		2307SK; H2307X		40	46	5	71.5	1.5	0.165
35	31	58	10		1208SK; H 208X		44	52	5	73	1	0.174
	36	58	10		2208SK; H 308X		44	50	5	73	1	0.189
	36	58	10		1308SK; H 308X		44	56	5	81.5	1.5	0.189
	46	58	10		2308SK; H2308X		45	52	5	81.5	1.5	0.224
40	33	65	11		1209SK; H 209X		49	57	5	78	1	0.227
	39	65	11		2209SK; H 309X		49	57	8	78	1	0.248
	39	65	11		1309SK; H 309X		49	61	5	91.5	1.5	0.248
	50	65	11		2309SK; H2309X		50	58	5	91.5	1.5	0.28
45	35	70	12		1210SK; H 210X		53	62	5	83	1	0.274
	42	70	12		2210SK; H 310X		54	63	10	83	1	0.303
	42	70	12		1310SK; H 310X		54	67	5	100	2	0.303
	55	70	12		2310SK; H2310X		56	65	5	100	2	0.362
50	37	75	12		1211SK; H 211X		60	70	6	91.5	1.5	0.308

1) Indicates adapter mass.

Note: 1. Refer to pages B-82 to B-85 for bearing dimensions, basic rated loads, and mass.

2. Adapters for series 12 bearings can also be used with H2 and H3 series bearings. Caution: the B_1 dimension of H3 series bearings is longer than that of H2 series bearings.

3. Adapter numbers which are appended with the code "X" indicate narrow slit type adapters which use washers with straight inner tabs.

4. Refer to pages D-2 to D-7 and D-12 to D-14 for adapter locknut and washer dimensions.

(For self-aligning ball bearings)

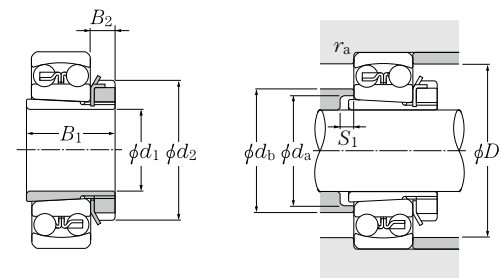

d 50 ~ 85mm

	Boundary dimensions				Numbers		Installation-related dimensions					Mass ¹⁾
	mm				Bearing	Adapter	d_a	d_b	mm	D_a	r_{as}	kg
	d_1	B_1	d_2	B_2			Min.	Max.	S_1 Min.	Max.	Max.	(approx.)
50	45	75	12		2211SK; H 311X		60	69	11	91.5	1.5	0.345
	45	75	12		1311SK; H 311X		60	73	6	110	2	0.345
	59	75	12		2311SK; H2311X		61	71	6	110	2	0.42
55	38	80	13		1212SK; H 212X		64	76	5	101.5	1.5	0.346
	47	80	13		2212SK; H 312X		65	75	9	101.5	1.5	0.394
	47	80	13		1312SK; H 312X		65	79	5	118	2	0.394
	62	80	13		2312SK; H2312X		66	77	5	118	2	0.481
60	40	85	14		1213SK; H 213X		70	83	5	111.5	1.5	0.401
	50	85	14		2213SK; H 313X		70	81	8	111.5	1.5	0.458
	50	85	14		1313SK; H 313X		70	85	5	128	2	0.458
	65	85	14		2313SK; H2313X		72	84	5	128	2	0.557
65	43	98	15		1215SK; H 215X		80	93	5	121.5	1.5	0.707
	55	98	15		2215SK; H 315X		80	93	12	121.5	1.5	0.831
	55	98	15		1315SK; H 315X		80	97	5	148	2	0.831
	73	98	15		2315SK; H2315X		82	96	5	148	2	1.05
70	46	105	17		1216SK; H 216X		85	100	5	130	2	0.882
	59	105	17		2216SK; H 316X		86	98	12	130	2	1.03
	59	105	17		1316SK; H 316X		86	103	5	158	2	1.03
	78	105	17		2316SK; H2316X		87	103	5	158	2	1.28
75	50	110	18		1217SK; H 217X		90	106	6	140	2	1.02
	63	110	18		2217SK; H 317X		91	104	12	140	2	1.18
	63	110	18		1317SK; H 317X		91	110	6	166	2.5	1.18
	82	110	18		2317SK; H2317X		94	110	6	166	2.5	1.45
80	52	120	18		1218SK; H 218X		95	111	6	150	2	1.19
	65	120	18		2218SK; H 318X		96	112	10	150	2	1.37
	65	120	18		1318SK; H 318X		96	116	6	176	2.5	1.37
	86	120	18		2318SK; H2318X		99	117	6	176	2.5	1.69
85	55	125	19		1219SK; H 219X		101	118	7	158	2	1.37
	68	125	19		2219SK; H 319X		102	117	9	158	2	1.56

1) Indicates adapter mass.

Note: 1. Refer to pages B-84 to B-87 for bearing dimensions, basic rated loads, and mass.

2. Adapters for series 12 bearings can also be used with H2 and H3 series bearings. Caution: the B_1 dimension of H3 series bearings is longer than that of H2 series bearings.

3. Adapter numbers which are appended with the code "X" indicate narrow slit type adapters which use washers with straight inner tabs.

4. Refer to pages D-2 to D-7 and D-12 to D-14 for adapter locknut and washer dimensions.

(For self-aligning ball bearings)

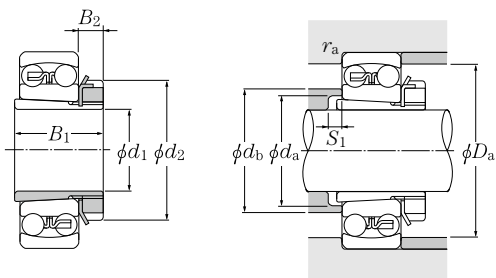

d 85 ~ 100mm

	Boundary dimensions				Numbers		Installation-related dimensions					Mass ¹⁾
	mm				Bearing	Adapter	d_a Min.	d_b Max.	mm S_1 Min.	D_a Max.	r_{as} Max.	kg (approx.)
	d_1	B_1	d_2	B_2								
85	68	125	19	1319SK; H 319X	102	123	7	186	2.5	1.56		
	90	125	19	2319SK; H2319X	105	123	7	186	2.5	1.92		
90	58	130	20	1220SK; H 220X	106	125	7	168	2	1.49		
	71	130	20	2220SK; H 320X	107	123	8	168	2	1.69		
	71	130	20	1320SK; H 320X	107	130	7	201	2.5	1.69		
	97	130	20	2320SK; H2320X	110	129	7	201	2.5	2.15		
100	63	145	21	1222SK; H 222X	116	138	7	188	2	1.93		
	77	145	21	2222SK; H 322X	117	137	6	188	2	2.18		
	77	145	21	1322SK; H 322X	117	150	9	226	2.5	2.18		
	105	145	21	2322SK; H2322X	121	142	7	226	2.5	2.74		

1) Indicates adapter mass.

Note: 1. Refer to pages B-86 to B-87 for bearing dimensions, basic rated loads, and mass.

2. Adapters for series 12 bearings can also be used with H2 and H3 series bearings. Caution: the B_1 dimension of H3 series bearings is longer than that of H2 series bearings.

3. Adapter numbers which are appended with the code "X" indicate narrow slit type adapters which use washers with straight inner tabs.

4. Refer to pages D-2 to D-9 and D-12 to D-14 for adapter locknut and washer dimensions.

Cylindrical Roller Bearings

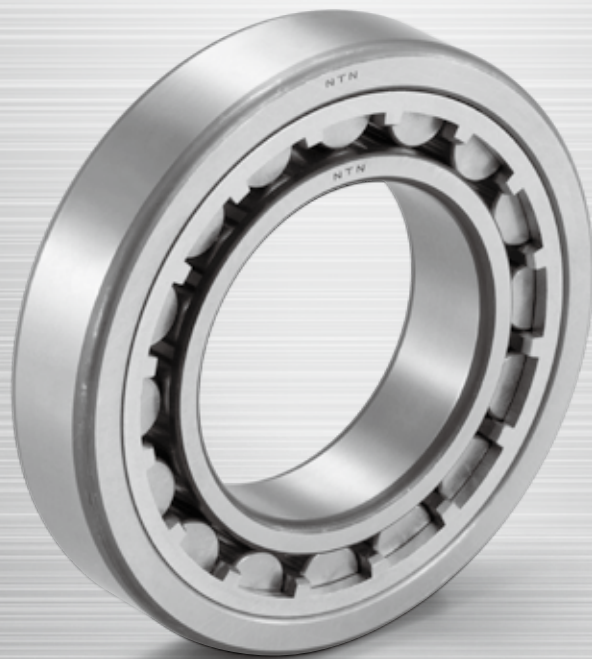

Cylindrical roller bearing



E Type cylindrical roller bearing



Double-row cylindrical roller bearing

1. Types, design features, and characteristics

Cylindrical roller bearings can accommodate heavy radial loads due to the line contact formed between their rolling elements and raceways. These bearings are also suitable for high speed applications since the rollers are guided by either inner or outer ring ribs. Cylindrical roller bearings are separable, allowing them to be easily installed and disassembled even when interference fits are required.

Among the various types of cylindrical roller bearings, E type and EA type have a high load capacity while maintaining standard boundary dimensions. HT type has a large axial load

capacity, and HL type provides extended fatigue life in poor lubrication conditions. Multiple row bearing arrangements are also available.

For extremely heavy load applications, the non-separable full complement SL type bearing offers special advantages. For SL type and four-row cylindrical roller bearings, see section "C. Special application bearings."

Table 1 shows the various types and characteristics of single row cylindrical roller bearings. Table 2 shows the characteristics of non-standard type cylindrical roller bearings.

Table 1 Cylindrical roller bearing types and characteristics







Type code	Design	Characteristics
NU type N type	 <p>NU type</p>  <p>N type</p>	<ul style="list-style-type: none"> • NU type outer rings have two ribs. The outer ring, roller, and cage assembly can be separated from the inner ring. • N type inner rings have two ribs. The inner ring, roller, and cage assembly can be separated from the outer ring. • Unable to accommodate any axial loading. • This is widely used as the floating side bearing in a fixed-float arrangement.
NJ type NF type	 <p>NJ type</p>  <p>NF type</p>	<ul style="list-style-type: none"> • NJ type has two ribs on the outer ring, a single rib on the inner ring; NF type has a single rib on the outer ring, and two ribs on the inner ring. • Can receive single direction axial loads. • When there is no distinction between the fixed side and floating side bearing, these types can be used as a pair in close proximity.
NUP type NH type (NJ+HJ)	 <p>NUP type</p>  <p>NH type</p>	<ul style="list-style-type: none"> • NUP type has a collar ring attached to the ribless side of the inner ring; NH type is NJ type with an L type collar ring attached. All of these collar rings are separable, and therefore it is necessary to fix the inner ring axially. • Can accommodate axial loads in either direction. • Widely used as the shaft's fixed-side bearing.

Table 2 Non-standard type cylindrical roller bearing characteristics

Designation	Characteristics
E type and EA type Cylindrical roller bearing	<ul style="list-style-type: none"> Boundary dimensions are the same as the standard type, but the diameter, length and number of the rollers have been increased, resulting in higher load capacity. Identified by the addition of "E" to the end of the basic roller number. Enables compact design due increased load rating. Rollers' inscribed circle diameter differs from the standard type rollers and therefore cannot be interchanged. EA type bearings are ULTAGE series¹⁾.  <p>Note: In the dimension tables, both E type and EA type are listed.</p>
Cylindrical roller bearing for axial loads (HT type)	<ul style="list-style-type: none"> Can accommodate larger axial loads than the standard type due to improved geometry of the rib roller end surface. Please consult NTN Engineering concerning necessary considerations, such as load, lubricant, and installation conditions.
Double-row cylindrical roller bearing	<ul style="list-style-type: none"> NN type and NNU type are available. Widely used for applications requiring thin-walled bearings, such the main shafts of machine tools, rolling machine rollers, and in printing equipment. Internal radial clearance is adjusted for the spindle of machine tools by pressing the tapered bore of the inner ring on a tapered shaft. <p>Remarks: For precision bearings for machine tools, see precision rolling bearings (CAT. No. 2260/E).</p>

1) ULTAGE series cylindrical roller bearings has been developed for "longer life," "improved loading capability," and "higher speed," which are required for various types of industrial machinery. For details, see **the special catalog (CAT. No. 3037/E)**.



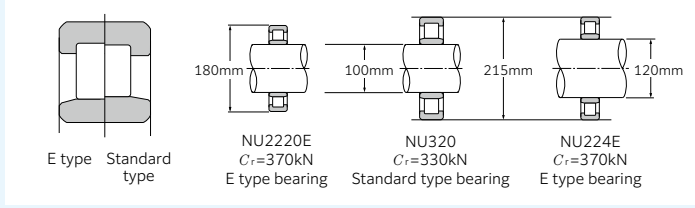

2. Standard cage type

Table 3 shows the standard cage types for cylindrical roller bearings.

The basic load ratings listed in the dimension charts correspond to use of the standard cages listed in Table 3. The basic load ratings

listed in the dimension tables are for standard configurations. These ratings can change when a different cage type and number of rolling elements is utilized.

Table 3 Standard cage types

Cage type	Resin cage	Pressed cage	Machined cage	
			Single type	Studded double type
				
Bearing series				
NU10	—	—	—	1005 to 10/500
NU2	—	208 to 230	232 to 240	244 to 264
NU2E	—	—	220E to 240E	—
NU2EA	204EA to 219EA	—	—	—
NU22	—	2208 to 2230	2232 to 2240	2244 to 2264
NU22E	—	—	2219E to 2240E	—
NU22EA	2204EA to 2218EA	—	—	—
NU3	—	308 to 324	326 to 330	332 to 356
NU3E	—	—	316E to 332E	—
NU3EA	304EA to 315EA	—	—	—
NU23	—	2308 to 2320	2322 to 2330	2332 to 2356
NU23E	—	—	2316E to 2332E	—
NU23EA	2304EA to 2315EA	—	—	—
NU4	—	405 to 416	—	—

Note: 1. Within the same bearing series, cage type is constant regardless of the cylindrical roller bearing type (NJ, NUP, N, NF).
 2. For high speed and other special applications, machined cages can be manufactured when necessary. Consult **NTN Engineering**.
 3. Among EA type bearings that use resin cages as standard, certain varieties use pressed cages. Consult **NTN Engineering**.
 4. Although machined cages are the standard for two-row cylindrical roller bearings, resin cages may also be used in some of these bearings for machine tool applications.

3. Allowable misalignment

Edge loading due to misalignment under general load conditions should be avoided to prevent premature bearing failure. The maximum allowable misalignment based on bearing series can be found below. The values apply when the bearings are to be used as the floating side of NU and N types. For NJ, NUP, and NH types that are to be used for the fixed side, consult NTN Engineering. Depending on the magnitude of the axial load, the edge loading may exceed recommended limits, which could lead to a reduction in bearing life.

- Bearing series 0 or 1 1/1 000
- Bearing series 2 1/2 000
- Bearing series 0, 1, and 2 single-row ULTAGE 1/500
- Double-row cylindrical roller bearings¹⁾ 1/2 000

1) Does not include high precision bearings for machine tool main shaft applications.

4. Combinations of cylindrical roller bearings

Table 4 shows the representative combinations of bearings.

Table 4 Combination type

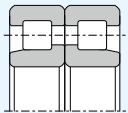
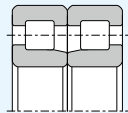
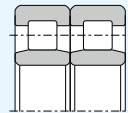
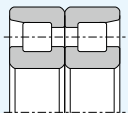
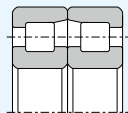
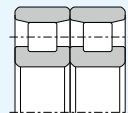
Back-to-back arrangement (DB)	Face-to-face arrangement (DF)	Symmetrical parts arrangement (D2)
 NJ type	 NJ type	 NU type
 NF type	 NF type	 N type

Note: 1. Bearings are manufactured in a set so that two bearings receive a load evenly; therefore, they must be assembled together with identically numbered bearings and not mixed with other arrangements.
2. Triplex arrangements of bearings are also available. Consult NTN Engineering for details.

5. Tolerance of inscribed circle diameter and circumscribed circle diameter of rollers of interchangeable cylindrical roller bearings

Table 5 Tolerance of inscribed circle diameter and circumscribed circle diameter of rollers of interchangeable cylindrical roller bearings Unit: μm

Nominal bore diameter		Dimensional tolerance of roller inscribed circle diameter Δ_{Fw}		Dimensional tolerance of roller circumscribed circle diameter Δ_{Ew}	
d (mm)		Upper	Lower	Upper	Lower
Over	Incl.				
17 ¹⁾	20	+10	0	0	-10
20	50	+15	0	0	-15
50	120	+20	0	0	-20
120	200	+25	0	0	-25
200	250	+30	0	0	-30
250	315	+35	0	0	-35
315	400	+40	0	0	-40
400	500	+45	0	0	-45

1) 17 mm is included in this dimensional division.
Note: Interchangeable cylindrical roller bearings are bearings having the same number in the group. The bearing function is not impaired even if an outer ring is combined with an inner ring with rollers or an inner ring is combined with an outer ring with rollers.

6. Allowable speed of cylindrical roller bearing ULTAGE series

As the rotational speed of the bearing increases, the temperature of the bearing also increases because of the friction heat produced inside the bearing. Operation at excessive temperatures will significantly deteriorate the lubricant performance, causing abnormal temperature rises and seizure. Factors affecting the allowable speed of bearings are as follows.

- (1) Bearing type
- (2) Bearing size
- (3) Lubrication (grease lubrication, circulating lubrication, oil lubrication, etc.)
- (4) Bearing internal clearance (bearing internal clearance during operation)
- (5) Bearing load
- (6) Shaft and housing accuracy

The allowable speed specified in the bearing dimension table is the reference speed limit which allows for satisfactory heat dissipation and lubrication conditions before adversely affecting the bearing. The allowable speed of ULTAGE series cylindrical roller bearings specified in the catalog is defined as follows.

[Oil lubrication]

The allowable speed for oil lubrication is the speed at which the outer ring temperature reaches 80°C with room temperature spindle oil (lubrication oil viscosity: VG32) supplied at 1 liter/min under an operating load of 5% of the basic static load rating C_{0r} .

[Grease lubrication]

The allowable speed for grease lubrication is the speed at which the outer ring temperature reaches 80°C with lithium-based grease (consistency: NLGI3) filled 20%-30% of the free space under an operating load of 5% of the basic static load rating C_{0r} .

In either of the lubrication methods, the bearing temperature rise differs if the usage condition (operating load, rotational speed

pattern, lubricating condition, etc.) is different; therefore, the bearings must be selected with sufficient allowable speed as specified in the catalog.

If 80% of the allowable speed specified in the dimension table is exceeded or the bearing is used under vibration or impact conditions, please consult NTN Engineering.

See section "9. Allowable speed" for the definition of the allowable speed of the cylindrical roller bearings that are not part of the ULTAGE series.

Cylindrical Roller Bearings

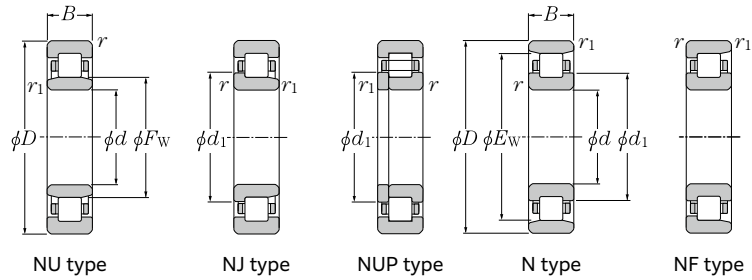

d 20 ~ 45mm

d	Boundary dimensions				Basic load rating		Fatigue load limit kN C _u	Allowable speed ²⁾		Bearing number ^{3) 4) 5)}			
	D	B	r _{s min¹⁾}	r _{1s min¹⁾}	d _r	C _{0r}		Grease lubrication	Oil lubrication	NU type	NJ type	NUP type	N type
20	47	14	1	0.6	32.5	24.7	3.00	15 000	21 600	*NU204EA	NJ	NUP	N
	47	18	1	0.6	38.5	31.0	3.75	14 000	19 200	*NU2204EA	NJ	NUP	N
	52	15	1.1	0.6	37.5	26.9	3.25	13 000	18 000	*NU304EA	NJ	NUP	N
	52	21	1.1	0.6	49.5	39.0	4.75	12 000	16 800	*NU2304EA	NJ	NUP	N
25	47	12	0.6	0.3	16.7	14.1	1.72	16 000	19 000	NU1005	NJ	NUP	N
	52	15	1	0.6	34.5	27.7	3.40	13 000	18 000	*NU205EA	NJ	NUP	N
	52	18	1	0.6	41.5	34.5	4.25	11 000	15 600	*NU2205EA	NJ	NUP	N
	62	17	1.1	1.1	49.0	37.5	4.55	11 000	15 600	*NU305EA	NJ	NUP	N
	62	24	1.1	1.1	67.5	56.0	6.85	9 700	13 200	*NU2305EA	NJ	NUP	N
	80	21	1.5	1.5	51.5	40.0	4.85	8 500	10 000	NU405	NJ	NUP	N
30	55	13	1	0.6	21.8	19.6	2.39	14 000	16 000	NU1006	NJ	NUP	N
	62	16	1	0.6	46.0	37.5	4.55	11 000	15 600	*NU206EA	NJ	NUP	N
	62	20	1	0.6	58.0	50.0	6.10	9 700	13 200	*NU2206EA	NJ	NUP	N
	72	19	1.1	1.1	63.0	50.0	6.15	9 300	13 200	*NU306EA	NJ	NUP	N
	72	27	1.1	1.1	88.0	77.5	9.45	8 300	11 600	*NU2306EA	NJ	NUP	N
	90	23	1.5	1.5	69.5	55.0	6.70	7 300	8 500	NU406	NJ	NUP	N
35	62	14	1	0.6	25.1	23.2	2.82	12 000	15 000	NU1007	NJ	NUP	N
	72	17	1.1	0.6	59.5	50.0	6.10	9 500	13 200	*NU207EA	NJ	NUP	N
	72	23	1.1	0.6	73.0	65.5	7.95	8 500	12 000	*NU2207EA	NJ	NUP	N
	80	21	1.5	1.1	83.5	71.0	8.65	8 100	11 500	*NU307EA	NJ	NUP	N
	80	31	1.5	1.1	117	109	13.3	7 200	10 200	*NU2307EA	NJ	NUP	N
100	25	1.5	1.5	83.5	69.0	8.40	6 400	7 500	NU407	NJ	NUP	N	
40	68	15	1	0.6	30.5	29.0	3.55	11 000	13 000	NU1008	NJ	NUP	N
	80	18	1.1	1.1	48.5	43.0	5.25	9 400	11 000	*NU208	NJ	NUP	N
	80	18	1.1	1.1	66.0	55.5	6.75	8 500	12 000	*NU208EA	NJ	NUP	N
	80	23	1.1	1.1	64.5	62.0	7.55	8 500	10 000	*NU2208	NJ	NUP	N
	80	23	1.1	1.1	85.5	77.5	9.45	7 600	10 700	*NU2208EA	NJ	NUP	N
	90	23	1.5	1.5	65.0	57.0	6.95	8 000	9 400	*NU308	NJ	NUP	N
	90	23	1.5	1.5	98.5	81.5	9.95	7 200	10 200	*NU308EA	NJ	NUP	N
	90	33	1.5	1.5	91.5	88.0	10.7	7 000	8 200	*NU2308	NJ	NUP	N
	90	33	1.5	1.5	135	122	14.9	6 400	9 000	*NU2308EA	NJ	NUP	N
110	27	2	2	106	89.0	10.9	5 700	6 700	NU408	NJ	NUP	N	
45	75	16	1	0.6	34.5	34.0	4.10	9 900	12 000	NU1009	NJ	NUP	N

1) Smallest allowable dimension for chamfer dimension r or r₁.
 2) This value is for machined cages; when pressed cages are used, 80% of this value is acceptable.
 3) Bearing numbers marked "*" designate ULTAGE series bearings. 4) Bearing marked "*" are going to be integrated with ULTAGE Series.

Cylindrical Roller Bearings

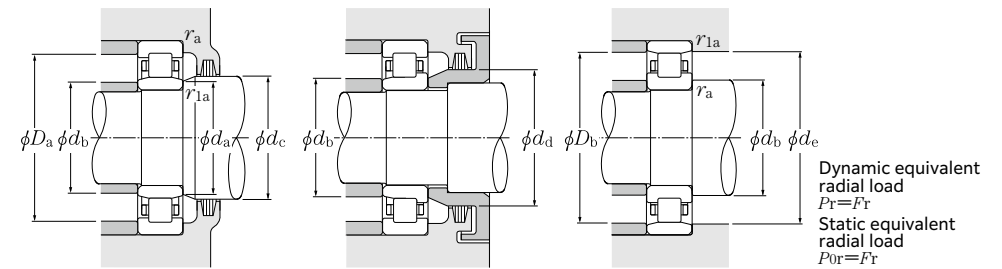

Dynamic equivalent radial load
P_r = F_r
 Static equivalent radial load
P_{0r} = F_r

NF type	Dimension					Installation-related dimensions								Mass	
	F _w	E _w	d ₁	d _a Min.	d _e Min.	d _b Max.	d _c Min.	d _d Min.	d _a Max.	D _b Max.	D _b Min. ⁶⁾	r _{as} Max.	r _{1as} Max.	NU type (approx.)	N type
NF	26.5	41.5	29.5	24	25	26	29	32	42	42	42.5	1	0.6	0.115	0.11
NF	26.5	41.5	29.5	24	25	26	29	32	42	42	42.5	1	0.6	0.146	0.144
NF	27.5	45.5	31.1	24	26.5	27	30	33	45.5	45.5	46.5	1	0.6	0.176	0.147
NF	27.5	45.5	31.1	24	26.5	27	30	33	45.5	45.5	46.5	1	0.6	0.242	0.212
—	30.5	41.5	32.7	27	29	30	32	33	43	45	42.5	0.6	0.3	0.092	0.091
NF	31.5	46.5	34.5	29	30	31	34	37	47	47	47.5	1	0.6	0.151	0.13
NF	31.5	46.5	34.5	29	30	31	34	37	47	47	47.5	1	0.6	0.186	0.163
NF	34	54	38	31.5	31.5	33	37	40	55.5	55.5	55	1	1	0.275	0.242
NF	34	54	38	31.5	31.5	33	37	40	55.5	55.5	55	1	1	0.386	0.345
NF	38.8	62.8	43.6	33	33	38	41	46	72	72	64	1.5	1.5	0.55	0.536
—	36.5	48.5	38.9	34	35	35	38	39.5	50	51	49.5	1	0.6	0.13	0.128
NF	37.5	55.5	41.1	34	35	37	40	44	57	57	56.5	1	0.6	0.226	0.205
NF	37.5	55.5	41.1	34	35	37	40	44	57	57	56.5	1	0.6	0.297	0.259
NF	40.5	62.5	44.9	36.5	36.5	40	44	48	65.5	65.5	64	1	1	0.398	0.353
NF	40.5	62.5	44.9	36.5	36.5	40	44	48	65.5	65.5	64	1	1	0.58	0.526
NF	45	73	50.5	38	38	44	47	52	82	82	74	1.5	1.5	0.751	0.732
—	42	55	44.6	39	40	41	44	45	57	58	56	1	0.6	0.179	0.176
NF	44	64	48	39	41.5	43	46	50	65.5	65.5	65.5	1	0.6	0.327	0.294
NF	44	64	48	39	41.5	43	46	50	65.5	65.5	65.5	1	0.6	0.455	0.405
NF	46.2	70.2	51	41.5	43	45	48	53	72	72	71.5	1.5	1	0.545	0.483
NF	46.2	70.2	51	41.5	43	45	48	53	72	72	71.5	1.5	1	0.78	0.737
NF	53	83	59	43	43	52	55	61	92	92	84	1.5	1.5	0.99	0.965
—	47	61	49.8	44	45	46	49	50.5	63	64	62	1	0.6	0.22	0.217
NF	50	70	54.2	46.5	46.5	49	52	56	73.5	73.5	72	1	1	0.378	0.37
NF	49.5	71.5	53.9	46.5	46.5	49	52	56	73.5	73.5	72.5	1	1	0.426	0.365
—	50	70	54.2	46.5	46.5	49	52	56	73.5	73.5	72	1	1	0.49	0.48
NF	49.5	71.5	53.9	46.5	46.5	49	52	56	73.5	73.5	72.5	1	1	0.552	0.491
NF	53.5	77.5	58.4	48	48	51	55	60	82	82	80	1.5	1.5	0.658	0.643
NF	52	80	57.6	48	48	51	55	60	82	82	81.5	1.5	1.5	0.754	0.658
—	53.5	77.5	58.4	48	48	51	55	60	82	82	80	1.5	1.5	0.951	0.932
NF	52	80	57.6	48	48	51	55	60	82	82	81.5	1.5	1.5	1.06	0.952
NF	58	92	64.8	49	49	57	60	67	101	101	93	2	2	1.3	1.27
—	52.5	67.5	55.5	49	50	52	54	56	70	71	68.5	1	0.6	0.28	0.276

5) Bearing numbers having no standard form are switched to type E or ULTAGE Series.
 6) Does not apply to the sides of the outer ring rib of type NF bearings.

Cylindrical Roller Bearings

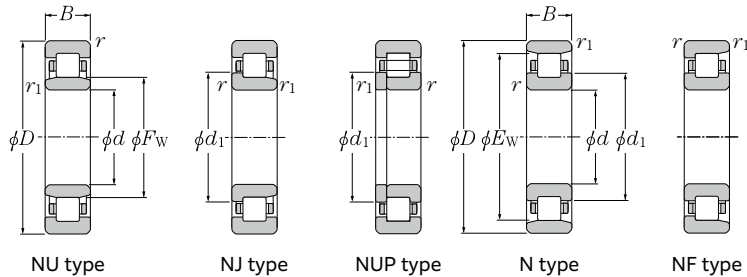

d 45 ~ 60mm

d	Boundary dimensions				Basic load rating		Fatigue load limit kN C_u	Allowable speed ²⁾		Bearing number ³⁾⁴⁾			
	D	B	$r_s \text{ min}^{1)}$	$r_{1s} \text{ min}^{1)}$	dynamic kN C_r	static kN C_{0r}		Grease lubrication	Oil lubrication	NU type	NJ type	NUP type	N type
45	85	19	1.1	1.1	51.0	47.0	5.70	8 400	9 900	**NU209	NJ	NUP	N
	85	19	1.1	1.1	74.5	66.5	8.10	7 600	10 800	**NU209EA	NJ	NUP	N
	85	23	1.1	1.1	68.0	68.0	8.25	7 600	9 000	**NU2209	NJ	NUP	N
	85	23	1.1	1.1	90.0	84.5	10.3	6 800	9 600	**NU2209EA	NJ	NUP	N
	100	25	1.5	1.5	82.0	71.0	8.65	7 200	8 400	**NU309	NJ	NUP	N
	100	25	1.5	1.5	115	98.5	12.0	6 500	9 100	**NU309EA	NJ	NUP	N
	100	36	1.5	1.5	110	104	12.7	6 300	7 400	**NU2309	NJ	NUP	N
	100	36	1.5	1.5	162	153	18.7	5 700	8 200	**NU2309EA	NJ	NUP	N
	120	29	2	2	119	102	12.4	5 100	6 000	NU409	NJ	NUP	N
50	80	16	1	0.6	35.5	36.0	4.40	8 900	11 000	NU1010	NJ	NUP	N
	90	20	1.1	1.1	53.5	51.0	6.20	7 600	9 000	**NU210	NJ	NUP	N
	90	20	1.1	1.1	81.5	76.5	9.30	6 900	9 700	**NU210EA	NJ	NUP	N
	90	23	1.1	1.1	71.0	73.5	9.00	6 900	8 100	**NU2210	NJ	NUP	N
	90	23	1.1	1.1	98.5	97.0	11.9	6 200	8 800	**NU2210EA	NJ	NUP	—
	110	27	2	2	96.5	86.0	10.5	6 500	7 700	**NU310	NJ	NUP	N
	110	27	2	2	130	113	13.8	5 900	8 300	**NU310EA	NJ	NUP	N
	110	40	2	2	134	131	16.0	5 700	6 700	**NU2310	NJ	NUP	N
	110	40	2	2	192	187	22.7	5 200	7 300	**NU2310EA	NJ	NUP	N
130	31	2.1	2.1	143	124	15.1	4 700	5 500	NU410	NJ	NUP	N	
55	90	18	1.1	1	42.0	44.0	5.35	8 200	9 700	NU1011	NJ	NUP	N
	100	21	1.5	1.1	64.5	62.5	7.60	6 900	8 200	**NU211	NJ	NUP	N
	100	21	1.5	1.1	102	98.5	12.0	6 300	8 900	**NU211EA	NJ	NUP	N
	100	25	1.5	1.1	83.5	87.0	10.6	6 300	7 400	**NU2211	NJ	NUP	N
	100	25	1.5	1.1	120	122	14.8	5 600	7 900	**NU2211EA	NJ	NUP	N
	120	29	2	2	123	111	13.6	5 900	7 000	**NU311	NJ	NUP	N
	120	29	2	2	162	143	17.4	5 300	7 600	**NU311EA	NJ	NUP	N
	120	43	2	2	164	162	19.8	5 200	6 100	**NU2311	NJ	NUP	N
	120	43	2	2	238	233	28.4	4 700	6 700	**NU2311EA	NJ	NUP	N
140	33	2.1	2.1	154	138	16.9	4 300	5 000	NU411	NJ	NUP	N	
60	95	18	1.1	1	44.5	48.5	5.95	7 500	8 800	NU1012	NJ	NUP	N
	110	22	1.5	1.5	76.0	75.0	9.15	6 400	7 600	**NU212	NJ	NUP	N
	110	22	1.5	1.5	115	107	13.1	5 800	8 200	**NU212EA	NJ	NUP	N
	110	28	1.5	1.5	107	116	14.1	5 800	6 800	**NU2212	NJ	NUP	N
	110	28	1.5	1.5	155	157	19.1	5 200	7 300	**NU2212EA	NJ	NUP	N

1) Smallest allowable dimension for chamfer dimension r or r_1 .
 2) This value is for machined cages; when pressed cages are used, 80% of this value is acceptable.
 3) Bearing numbers marked "*" designate ULTAGE series bearings. 4) Bearing marked "**" are going to be integrated with ULTAGE Series.

Cylindrical Roller Bearings

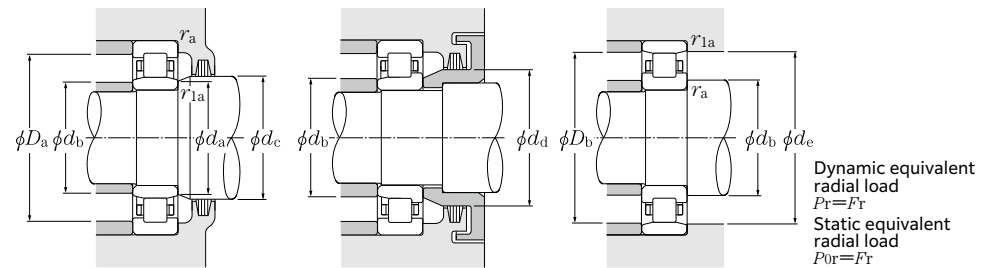

NF type	Dimension				Installation-related dimensions							Mass				
	F_w	E_w	d_1	mm	d_a	d_e	d_b	d_c	d_d	mm	D_a	D_b	r_{as}	r_{1as}	kg	kg
				Min.	Min.	Max.	Min.	Min.	Min.	Max.	Max.	Min. ⁵⁾	Max.	Max.	NU type	N type
NF	55	75	59	51.5	51.5	54	57	61	78.5	78.5	77	1	1	0.432	0.423	
NF	54.5	76.5	58.9	51.5	51.5	54	57	61	78.5	78.5	77.5	1	1	0.495	0.487	
—	55	75	59	51.5	51.5	54	57	61	78.5	78.5	77	1	1	0.53	0.52	
NF	54.5	76.5	58.9	51.5	51.5	54	57	61	78.5	78.5	77.5	1	1	0.6	0.533	
NF	58.5	86.5	64	53	53	57	60	66	92	92	89	1.5	1.5	0.877	0.857	
NF	58.5	88.5	64.5	53	53	57	60	66	92	92	90.5	1.5	1.5	0.996	0.865	
—	58.5	86.5	64	53	53	57	60	66	92	92	89	1.5	1.5	1.27	1.24	
NF	58.5	88.5	64.5	53	53	57	60	66	92	92	90.5	1.5	1.5	1.41	1.3	
NF	64.5	100.5	71.8	54	54	63	66	74	111	111	102	2	2	1.62	1.58	
—	57.5	72.5	60.5	54	55	57	59	61	75	76	73.5	1	0.6	0.295	0.291	
NF	60.4	80.4	64.6	56.5	56.5	58	62	67	83.5	83.5	83	1	1	0.47	0.46	
NF	59.5	81.5	63.9	56.5	56.5	58	62	67	83.5	83.5	82.5	1	1	0.503	0.47	
—	60.4	80.4	64.6	56.5	56.5	58	62	67	83.5	83.5	83	1	1	0.571	0.56	
NF	59.5	81.5	63.9	56.5	56.5	58	62	67	83.5	83.5	82.5	1	1	0.587	—	
NF	65	95	71	59	59	63	67	73	101	101	98	2	2	1.14	1.11	
NF	65	97	71.4	59	59	63	67	73	101	101	99	2	2	1.3	1.12	
—	65	95	71	59	59	63	67	73	101	101	98	2	2	1.7	1.67	
NF	65	97	71.4	59	59	63	67	73	101	101	99	2	2	1.9	1.75	
NF	70.8	110.8	78.8	61	61	69	73	81	119	119	112	2	2	2.02	1.97	
—	64.5	80.5	67.7	60	61.5	63	66	68.5	83.5	85	81.5	1	1	0.442	0.435	
NF	66.5	88.5	70.8	61.5	63	65	68	73	92	93.5	91	1.5	1	0.638	0.626	
NF	66	90	70.8	61.5	63	65	68	73	92	92	91	1.5	1	0.675	0.635	
—	66.5	88.5	70.8	61.5	63	65	68	73	92	93.5	91	1.5	1	0.773	0.758	
NF	66	90	70.8	61.5	63	65	68	73	92	92	91	1.5	1	0.807	—	
NF	70.5	104.5	77.2	64	64	69	72	80	111	111	107	2	2	1.45	1.42	
NF	70.5	106.5	77.7	64	64	69	72	80	111	111	108.5	2	2	1.65	1.43	
—	70.5	104.5	77.2	64	64	69	72	80	111	111	107	2	2	2.17	2.13	
NF	70.5	106.5	77.7	64	64	69	72	80	111	111	108.5	2	2	2.37	2.23	
NF	77.2	117.2	85.2	66	66	76	79	87	129	129	119	2	2	2.48	2.42	
—	69.5	85.5	72.7	65	66.5	68	71	73.5	88.5	90	86.5	1	1	0.474	0.467	
NF	73.5	97.5	78.4	68	68	71	75	80	102	102	100	1.5	1.5	0.818	0.802	
NF	72	100	77.6	68	68	71	75	80	102	102	101	1.5	1.5	0.923	0.798	
—	73.5	97.5	78.4	68	68	71	75	80	102	102	100	1.5	1.5	1.06	1.04	
NF	72	100	77.6	68	68	71	75	80	102	102	101	1.5	1.5	1.21	1.08	

5) Does not apply to the sides of the outer ring rib of type NF bearings.

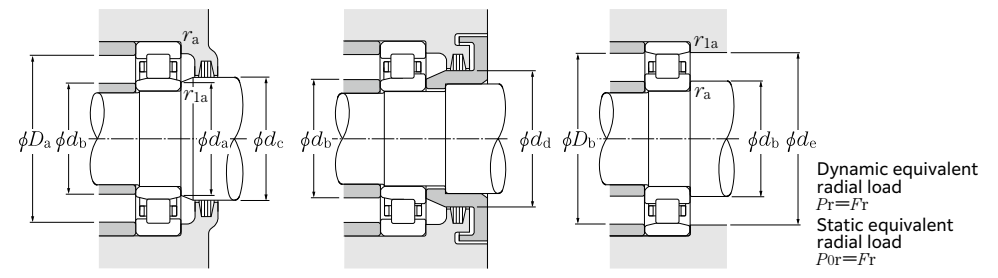
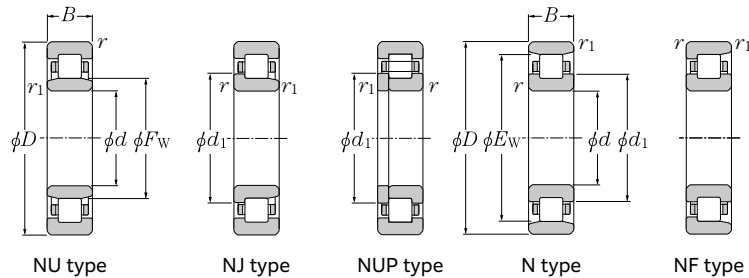

d 60 ~ 75mm

d	Boundary dimensions				Basic load rating		Fatigue load limit kN Cu	Allowable speed ²⁾		Bearing number ^{3) 4)}			
	mm				dynamic	static		min ⁻¹					
	D	B	r _{s min¹⁾}	r _{1s min¹⁾}	C _r	C _{0r}		Grease lubrication	Oil lubrication	NU type	NJ type	NUP type	N type
60	130	31	2.1	2.1	137	126	15.4	5 500	6 500	**NU312	NJ	NUP	N
	130	31	2.1	2.1	177	157	19.1	4 900	7 000	**NU312EA	NJ	NUP	N
	130	46	2.1	2.1	187	188	22.9	4 800	5 700	**NU2312	NJ	NUP	N
	130	46	2.1	2.1	263	262	32.0	4 400	6 200	**NU2312EA	NJ	NUP	N
	150	35	2.1	2.1	185	168	20.2	3 900	4 600	NU412	NJ	NUP	N
65	100	18	1.1	1	45.5	51.0	6.30	7 000	8 200	NU1013	NJ	NUP	N
	120	23	1.5	1.5	93.0	94.5	11.5	5 900	7 000	**NU213	NJ	NUP	N
	120	23	1.5	1.5	127	119	14.5	5 400	7 600	**NU213EA	NJ	NUP	N
	120	31	1.5	1.5	133	149	18.2	5 400	6 300	**NU2213	NJ	NUP	N
	120	31	1.5	1.5	176	181	22.1	4 800	6 700	**NU2213EA	NJ	NUP	N
	140	33	2.1	2.1	150	139	16.8	5 100	6 000	**NU313	NJ	NUP	N
	140	33	2.1	2.1	213	191	23.1	4 600	6 500	**NU313EA	NJ	NUP	N
	140	48	2.1	2.1	208	212	25.7	4 400	5 200	**NU2313	NJ	NUP	N
	140	48	2.1	2.1	293	287	34.5	4 100	5 800	**NU2313EA	NJ	NUP	N
160	37	2.1	2.1	202	186	21.9	3 600	4 300	NU413	NJ	NUP	N	
70	110	20	1.1	1	64.5	70.5	8.60	6 500	7 600	NU1014	NJ	NUP	N
	125	24	1.5	1.5	92.5	95.0	11.6	5 500	6 500	**NU214	NJ	NUP	N
	125	24	1.5	1.5	140	137	16.7	5 000	7 100	**NU214EA	NJ	NUP	N
	125	31	1.5	1.5	132	151	18.4	5 000	5 900	**NU2214	NJ	NUP	N
	125	31	1.5	1.5	184	194	23.7	4 500	6 200	**NU2214EA	NJ	NUP	N
	150	35	2.1	2.1	175	168	20.0	4 700	5 500	**NU314	NJ	NUP	N
	150	35	2.1	2.1	242	222	26.2	4 200	6 000	**NU314EA	NJ	NUP	N
	150	51	2.1	2.1	247	262	31.0	4 100	4 800	**NU2314	NJ	NUP	N
	150	51	2.1	2.1	325	325	38.0	3 800	5 300	**NU2314EA	NJ	NUP	N
180	42	3	3	253	236	26.8	3 400	4 000	NU414	NJ	NUP	N	
75	115	20	1.1	1	66.5	74.5	9.10	6 100	7 100	NU1015	NJ	NUP	N
	130	25	1.5	1.5	107	111	13.4	5 100	6 000	**NU215	NJ	NUP	N
	130	25	1.5	1.5	154	156	18.9	4 700	6 600	**NU215EA	NJ	NUP	N
	130	31	1.5	1.5	144	162	19.6	4 700	5 500	**NU2215	NJ	NUP	N
	130	31	1.5	1.5	191	207	25.0	4 200	5 900	**NU2215EA	NJ	NUP	N
	160	37	2.1	2.1	211	205	23.8	4 400	5 200	**NU315	NJ	NUP	N
	160	37	2.1	2.1	284	263	30.5	4 000	5 600	**NU315EA	NJ	NUP	N
	160	55	2.1	2.1	286	300	35.0	3 800	4 500	**NU2315	NJ	NUP	N
	160	55	2.1	2.1	390	395	45.5	3 500	4 900	**NU2315EA	NJ	NUP	N
190	45	3	3	291	274	30.5	3 200	3 700	NU415	NJ	NUP	N	

1) Smallest allowable dimension for chamfer dimension r or r₁.
 2) This value is for machined cages; when pressed cages are used, 80% of this value is acceptable.
 3) Bearing numbers marked "*" designate ULTAGE series bearings. 4) Bearing marked "**" are going to be integrated with ULTAGE Series.

NF type	Dimension				Installation-related dimensions								Mass		
	mm				mm								kg		
	F _w	E _w	d ₁	d _a Min.	d _e Min.	d _b Max.	d _c Min.	d _d Min.	D _a Max.	D _b Max. Min. ⁵⁾	r _{as} Max.	r _{1as} Max.	NU type (approx.)	N type	
NF	77	113	84.2	71	71	75	79	86	119	119	116	2	2	1.8	1.76
NF	77	115	84.6	71	71	75	79	86	119	119	117	2	2	2.05	1.77
—	77	113	84.2	71	71	75	79	86	119	119	116	2	2	2.71	2.66
NF	77	115	84.6	71	71	75	79	86	119	119	117	2	2	2.96	2.73
NF	83	127	91.8	71	71	82	85	94	139	139	128	2	2	3	2.93
—	74.5	90.5	77.7	70	71.5	73	76	78.5	93.5	95	91.5	1	1	0.485	0.477
NF	79.6	105.6	84.8	73	73	77	81	87	112	112	108	1.5	1.5	1.02	1
NF	78.5	108.5	84.5	73	73	77	81	87	112	112	110	1.5	1.5	1.21	1.01
—	79.6	105.6	84.8	73	73	77	81	87	112	112	108	1.5	1.5	1.4	1.37
NF	78.5	108.5	84.5	73	73	77	81	87	112	112	110	1.5	1.5	1.6	1.44
NF	83.5	121.5	91	76	76	81	85	93	129	129	125	2	2	2.23	2.18
NF	82.5	124.5	91	76	76	81	85	93	129	129	127	2	2	2.54	2.2
—	83.5	121.5	91	76	76	81	85	93	129	129	125	2	2	3.27	3.2
NF	82.5	124.5	91	76	76	81	85	93	129	129	127	2	2	3.48	3.25
NF	89.3	135.3	98.5	76	76	88	91	100	149	149	137	2	2	3.6	3.5
—	80	100	84	75	76.5	78	82	85	103.5	105	101	1	1	0.699	0.689
NF	84.5	110.5	89.6	78	78	82	86	92	117	117	114	1.5	1.5	1.12	1.1
NF	83.5	113.5	89.5	78	78	82	86	92	117	117	115	1.5	1.5	1.3	1.13
—	84.5	110.5	89.6	78	78	82	86	92	117	117	114	1.5	1.5	1.47	1.44
NF	83.5	113.5	89.5	78	78	82	86	92	117	117	115	1.5	1.5	1.7	1.52
NF	90	130	98	81	81	87	92	100	139	139	134	2	2	2.71	2.65
NF	89	133	98	81	81	87	92	100	139	139	136	2	2	3.1	2.75
—	90	130	98	81	81	87	92	100	139	139	134	2	2	3.98	3.9
NF	89	133	98	81	81	87	92	100	139	139	136	2	2	4.25	3.95
NF	100	152	110.5	83	83	99	102	112	167	167	153	2.5	2.5	5.24	5.1
—	85	105	89	80	81.5	83	87	90	108.5	110	106	1	1	0.738	0.727
NF	88.5	116.5	94	83	83	87	90	96	122	122	120	1.5	1.5	1.23	1.21
NF	88.5	118.5	94.5	83	83	87	90	96	122	122	120	1.5	1.5	1.41	1.28
—	88.5	116.5	94	83	83	87	90	96	122	122	120	1.5	1.5	1.55	1.52
NF	88.5	118.5	94.5	83	83	87	90	96	122	122	120	1.5	1.5	1.79	1.61
NF	95.5	139.5	104.2	86	86	93	97	106	149	149	143	2	2	3.28	3.21
NF	95	143	104.6	86	86	93	97	106	149	149	146	2	2	3.74	3.28
—	95.5	139.5	104.2	86	86	93	97	106	149	149	143	2	2	4.87	4.77
NF	95	143	104.6	86	86	93	97	106	149	149	—	2	2	5.25	4.85
NF	104.5	160.5	116	88	88	103	107	118	177	177	162	2.5	2.5	6.22	6.06

5) Does not apply to the sides of the outer ring rib of type NF bearings.

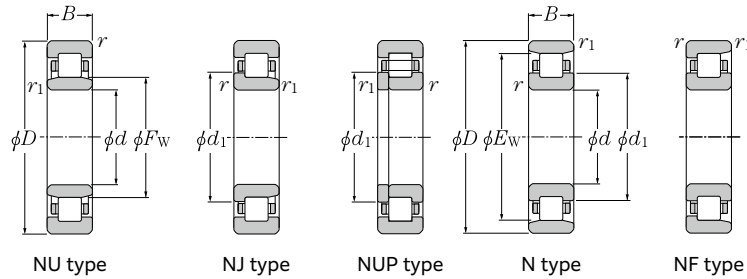

d 80 ~ 95mm

	Boundary dimensions				Basic load rating		Fatigue load limit kN C _u	Allowable speed ²⁾		Bearing number ^{3) 4)}			
	d	D	B	r _s min ¹⁾	r _{1s} min ¹⁾	C _r		C _{0r}	Grease lubrication	Oil lubrication	NU type	NJ type	NUP type
80	125	22	1.1	1	80.0	90.5	11.0	5 700	6 700	NU1016	NJ	NUP	N
	140	26	2	2	118	122	14.5	4 800	5 700	**NU216	NJ	NUP	N
	140	26	2	2	165	167	19.7	4 400	6 100	**NU216EA	NJ	NUP	N
	140	33	2	2	163	186	22.0	4 400	5 100	**NU2216	NJ	NUP	N
	140	33	2	2	220	243	28.7	3 900	5 500	**NU2216EA	NJ	NUP	N
	170	39	2.1	2.1	211	207	23.7	4 100	4 800	NU316	NJ	NUP	N
	170	39	2.1	2.1	284	282	32.0	3 700	4 400	NU316E	NJ	NUP	N
	170	58	2.1	2.1	305	330	38.0	3 600	4 200	NU2316	NJ	NUP	N
	170	58	2.1	2.1	395	430	49.0	3 300	3 900	NU2316E	NJ	NUP	N
200	48	3	3	330	315	34.5	3 000	3 500	NU416	NJ	NUP	N	
85	130	22	1.1	1	82.5	95.5	11.4	5 400	6 300	NU1017	NJ	NUP	N
	150	28	2	2	134	140	16.3	4 500	5 300	**NU217	NJ	NUP	N
	150	28	2	2	198	199	23.0	4 100	5 800	**NU217EA	NJ	NUP	N
	150	36	2	2	188	218	25.3	4 100	4 800	**NU2217	NJ	NUP	N
	150	36	2	2	257	279	32.5	3 700	5 200	**NU2217EA	NJ	NUP	N
	180	41	3	3	235	228	25.6	3 900	4 600	NU317	NJ	NUP	N
	180	41	3	3	325	330	37.0	3 500	4 100	NU317E	NJ	NUP	N
180	60	3	3	350	380	43.0	3 400	4 000	NU2317	NJ	NUP	N	
180	60	3	3	435	485	54.0	3 100	3 700	NU2317E	NJ	NUP	N	
90	140	24	1.5	1.1	98.0	114	13.4	5 100	5 900	NU1018	NJ	NUP	N
	160	30	2	2	169	178	20.3	4 300	5 000	**NU218	NJ	NUP	N
	160	30	2	2	215	217	24.7	3 900	5 500	**NU218EA	NJ	NUP	N
	160	40	2	2	219	248	28.3	3 900	4 600	**NU2218	NJ	NUP	N
	160	40	2	2	286	315	35.5	3 500	4 900	**NU2218EA	NJ	NUP	N
	190	43	3	3	266	265	29.3	3 700	4 300	NU318	NJ	NUP	N
	190	43	3	3	350	355	39.0	3 300	3 900	NU318E	NJ	NUP	N
190	64	3	3	360	395	43.5	3 200	3 800	NU2318	NJ	NUP	N	
190	64	3	3	485	535	58.5	2 900	3 400	NU2318E	NJ	NUP	N	
95	145	24	1.5	1.1	101	120	13.9	4 800	5 600	NU1019	NJ	NUP	N
	170	32	2.1	2.1	184	195	21.8	4 000	4 700	**NU219	NJ	NUP	N
	170	32	2.1	2.1	260	265	29.6	3 600	5 200	**NU219EA	NJ	NUP	N
	170	43	2.1	2.1	256	298	33.5	3 600	4 300	NU2219	NJ	NUP	N
	170	43	2.1	2.1	315	370	41.5	3 300	3 800	NU2219E	NJ	NUP	N
	200	45	3	3	287	289	31.5	3 400	4 000	NU319	NJ	NUP	N
200	45	3	3	370	385	42.0	3 100	3 600	NU319E	NJ	NUP	N	

1) Smallest allowable dimension for chamfer dimension r or r₁.
 2) This value is for machined cages; when pressed cages are used, 80% of this value is acceptable.
 3) Bearing numbers marked "*" designate ULTAGE series bearings. 4) Bearing marked "**" are going to be integrated with ULTAGE Series.

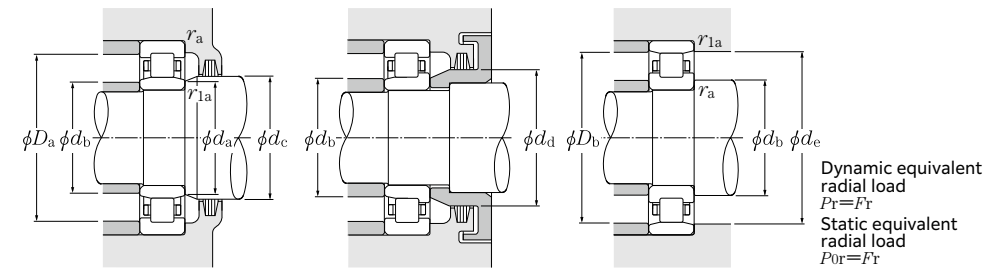

NF type	Dimension				Installation-related dimensions								Mass		
	F _w	E _w	d ₁	d _a Min.	d _e Min.	d _b Max.	d _c Min.	d _d Min.	d _a Max.	D _b Max.	r _{as} Max.	r _{1as} Max.	NU type (approx.)	N type (approx.)	
—	91.5	113.5	95.9	85	86.5	90	94	97	118.5	120	114.5	1	1	0.98	0.965
NF	95.3	125.3	101.2	89	89	94	97	104	131	131	128	2	2	1.5	1.47
NF	95.3	127.3	101.7	89	89	94	97	104	131	131	128.5	2	2	1.67	1.56
—	95.3	125.3	101.2	89	89	94	97	104	131	131	128	2	2	1.93	1.89
NF	95.3	127.3	101.7	89	89	94	97	104	131	131	128.5	2	2	2.12	2.02
NF	103	147	111.8	91	91	99	105	114	159	159	151	2	2	3.86	3.77
NF	101	151	111	91	91	99	105	114	159	159	154	2	2	4.22	4.12
—	103	147	111.8	91	91	99	105	114	159	159	151	2	2	5.79	5.67
NF	101	151	111	91	91	99	105	114	159	159	154	2	2	6.25	5.78
NF	110	170	122	93	93	109	112	124	187	187	172	2.5	2.5	7.32	7.14
—	96.5	118.5	100.9	90	91.5	95	99	102	123.5	125	119.5	1	1	1.03	1.01
NF	101.8	133.8	108.2	94	94	99	104	110	141	141	137	2	2	1.87	1.83
NF	100.5	136.5	107.7	94	94	99	104	110	141	141	138	2	2	2.11	1.93
—	101.8	133.8	108.2	94	94	99	104	110	141	141	137	2	2	2.44	2.39
NF	100.5	136.5	107.7	94	94	99	104	110	141	141	138	2	2	2.68	2.52
NF	108	156	117.5	98	98	106	110	119	167	167	160	2.5	2.5	4.54	4.44
—	108	—	118.4	98	—	106	110	119	167	—	—	2.5	2.5	4.81	—
—	108	156	117.5	98	98	106	110	119	167	167	160	2.5	2.5	6.7	6.57
—	108	—	118.4	98	—	106	110	119	167	—	—	2.5	2.5	7.16	—
—	103	127	107.8	96.5	98	101	106	109	132	133.5	129	1.5	1	1.33	1.31
NF	107	143	114.2	99	99	105	109	116	151	151	146	2	2	2.3	2.25
NF	107	145	114.6	99	99	105	109	116	151	151	147	2	2	2.44	2.37
—	107	143	114.2	99	99	105	109	116	151	151	146	2	2	3.1	3.04
NF	107	145	114.6	99	99	105	109	116	151	151	147	2	2	3.33	3.2
NF	115	165	125	103	103	111	117	127	177	177	169	2.5	2.5	5.3	5.18
—	113.5	—	124.7	103	—	111	117	127	177	—	—	2.5	2.5	5.72	—
—	115	165	125	103	103	111	117	127	177	177	169	2.5	2.5	7.95	7.79
—	113.5	—	124.7	103	—	111	117	127	177	—	—	2.5	2.5	8.56	—
—	108	132	112.8	101.5	103	106	111	114	137	138.5	134	1.5	1	1.4	1.38
NF	113.5	151.5	121	106	106	111	116	123	159	159	155	2	2	2.78	2.72
NF	112.5	154.5	121	106	106	111	116	123	159	159	156.5	2	2	3.02	2.85
—	113.5	151.5	121	106	106	111	116	123	159	159	155	2	2	3.79	3.71
NF	112.5	154.5	121	106	106	111	116	123	159	159	156.5	2	2	4.14	3.84
NF	121.5	173.5	132	108	108	119	124	134	187	187	178	2.5	2.5	6.13	5.99
—	121.5	—	132.7	108	—	119	124	134	187	—	—	2.5	2.5	6.62	—

5) Does not apply to the sides of the outer ring rib of type NF bearings.

Cylindrical Roller Bearings

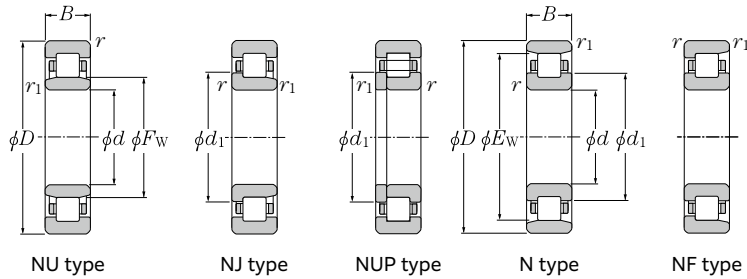

d 95 ~ 130mm

d	Boundary dimensions				Basic load rating		Fatigue load limit kN C _u	Allowable speed ²⁾		Bearing number			
	D	B	r _s min ¹⁾	r _{1s} min ¹⁾	dynamic kN C _r	static kN C _{0r}		Grease lubrication	Oil lubrication	NU type	NJ type	NUP type	N type
95	200	67	3	3	410	460	50.0	3 000	3 500	NU2319	NJ	NUP	N
	200	67	3	3	510	585	63.0	2 700	3 200	NU2319E	NJ	NUP	—
100	150	24	1.5	1.1	103	126	14.4	4 600	5 400	NU1020	NJ	NUP	N
	180	34	2.1	2.1	203	217	23.9	3 800	4 500	NU220	NJ	NUP	N
	180	34	2.1	2.1	277	305	33.5	3 500	4 100	NU220E	NJ	NUP	—
	180	46	2.1	2.1	286	340	37.5	3 500	4 100	NU220	NJ	NUP	N
	180	46	2.1	2.1	370	445	49.0	3 100	3 600	NU220E	NJ	NUP	—
	215	47	3	3	330	335	36.0	3 300	3 800	NU320	NJ	NUP	N
	215	47	3	3	420	425	45.0	2 900	3 500	NU320E	NJ	NUP	—
105	215	73	3	3	455	505	54.0	2 900	3 400	NU2320	NJ	NUP	N
	215	73	3	3	630	715	76.0	2 600	3 100	NU2320E	NJ	NUP	—
	160	26	2	1.1	117	142	16.0	4 300	5 100	NU1021	NJ	NUP	N
110	190	36	2.1	2.1	223	241	26.1	3 600	4 300	NU221	NJ	NUP	N
	225	49	3	3	355	360	37.5	3 100	3 700	NU321	NJ	NUP	N
	170	28	2	1.1	146	174	19.2	4 100	4 800	NU1022	NJ	NUP	N
	200	38	2.1	2.1	266	290	31.0	3 400	4 000	NU222	NJ	NUP	N
	200	38	2.1	2.1	325	365	39.0	3 100	3 700	NU222E	NJ	NUP	—
	200	53	2.1	2.1	350	415	44.0	3 100	3 700	NU2222	NJ	NUP	N
	200	53	2.1	2.1	425	515	55.0	2 800	3 300	NU2222E	NJ	NUP	—
120	240	50	3	3	395	400	41.5	3 000	3 500	NU322	NJ	NUP	N
	240	50	3	3	500	525	54.0	2 700	3 100	NU322E	NJ	NUP	—
	240	80	3	3	670	790	81.5	2 600	3 100	NU2322	NJ	NUP	N
	240	80	3	3	750	880	90.5	2 400	2 800	NU2322E	NJ	NUP	—
	180	28	2	1.1	154	191	20.6	3 800	4 400	NU1024	NJ	NUP	N
130	215	40	2.1	2.1	370	420	44.0	2 900	3 400	NU224E	NJ	NUP	—
	215	58	2.1	2.1	385	460	48.0	2 900	3 400	NU224	NJ	NUP	N
	215	58	2.1	2.1	500	620	64.5	2 600	3 000	NU224E	NJ	NUP	—
	260	55	3	3	500	510	51.0	2 700	3 200	NU324	NJ	NUP	N
	260	55	3	3	585	610	61.0	2 400	2 800	NU324E	NJ	NUP	—
	260	86	3	3	785	920	92.5	2 400	2 800	NU2324	NJ	NUP	N
	260	86	3	3	880	1 030	103	2 200	2 500	NU2324E	NJ	NUP	—
	200	33	2	1.1	191	238	24.9	3 400	4 000	NU1026	NJ	NUP	N

1) Smallest allowable dimension for chamfer dimension r or r₁.
2) This value is for machined cages; when pressed cages are used, 80% of this value is acceptable.

Cylindrical Roller Bearings

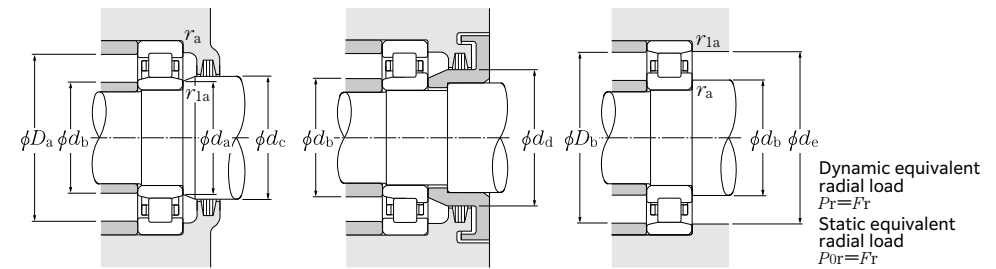

Dimension	Installation-related dimensions													Mass	
	mm	mm											kg		
NF type	F _w	E _w	d ₁	d _a Min.	d _e Min.	d _b Max.	d _c Min.	d _d Min.	d _a Max.	D _b Max.	D _b Min. ³⁾	r _{as} Max.	r _{1as} Max.	NU type (approx.)	N type (approx.)
—	121.5	173.5	132	108	108	119	124	134	187	187	178	2.5	2.5	9.2	9.02
—	121.5	—	132.7	108	—	119	124	134	187	—	—	2.5	2.5	9.8	—
—	113	137	117.8	106.5	108	111	116	119	142	143.5	139	1.5	1	1.45	1.43
NF	120	160	128	111	111	117	122	130	169	169	164	2	2	3.33	3.26
—	119	—	128	111	—	117	122	130	169	—	—	2	2	3.66	—
—	120	160	128	111	111	117	122	130	169	169	164	2	2	4.57	4.48
—	119	—	128	111	—	117	122	130	169	—	—	2	2	5.01	—
NF	129.5	185.5	140.5	113	113	125	132	143	202	202	190	2.5	2.5	7.49	7.32
—	127.5	—	140.3	113	—	125	132	143	202	—	—	2.5	2.5	8.57	—
—	129.5	185.5	140.5	113	113	125	132	143	202	202	190	2.5	2.5	11.7	11.5
—	127.5	—	140.3	113	—	125	132	143	202	—	—	2.5	2.5	12.8	—
—	119.5	145.5	124.7	111.5	114	118	122	126	151	153.5	147.5	2	1	1.84	1.81
NF	126.8	168.8	135	116	116	124	129	137	179	179	173	2	2	3.95	3.87
NF	135	195	147	118	118	132	137	149	212	212	199	2.5	2.5	8.53	8.33
—	125	155	131	116.5	119	124	128	132	161	163.5	157	2	1	2.33	2.3
NF	132.5	178.5	141.5	121	121	130	135	144	189	189	182	2	2	4.63	4.54
—	132.5	—	142.1	121	—	130	135	144	189	—	—	2	2	4.27	—
—	132.5	178.5	141.5	121	121	130	135	144	189	189	182	2	2	6.56	6.43
—	132.5	—	142.1	121	—	130	135	144	189	—	—	2	2	7.4	—
NF	143	207	155.5	123	123	140	145	158	227	227	211	2.5	2.5	10	9.77
—	143	—	156.6	123	—	140	145	158	227	—	—	2.5	2.5	11.1	11.4
—	143	207	155.5	123	123	140	145	158	227	227	211	2.5	2.5	17.1	16.8
—	143	—	156.6	123	—	140	145	158	227	—	—	2.5	2.5	19.4	—
—	135	165	141	126.5	129	134	138	142	171	173.5	167	2	1	2.44	2.4
NF	143.5	191.5	153	131	131	141	146	156	204	204	196	2	2	5.57	5.46
—	143.5	—	153.9	131	—	141	146	156	204	—	—	2	2	5.97	—
—	143.5	191.5	153	131	131	141	146	156	204	204	196	2	2	8.19	8.03
—	143.5	—	153.9	131	—	141	146	156	204	—	—	2	2	9.18	—
NF	154	226	168.5	133	133	151	156	171	247	247	230	2.5	2.5	12.8	12.5
—	154	—	169.2	133	—	151	156	171	247	—	—	2.5	2.5	13.9	—
—	154	226	168.5	133	133	151	156	171	247	247	230	2.5	2.5	21.5	21.1
—	154	—	169.2	133	—	151	156	171	247	—	—	2.5	2.5	26.1	—
—	148	182	154.8	136.5	139	146	151	156	191	193.5	184	2	1	3.69	3.63

3) Does not apply to the sides of the outer ring rib of type NF bearings.

Cylindrical Roller Bearings

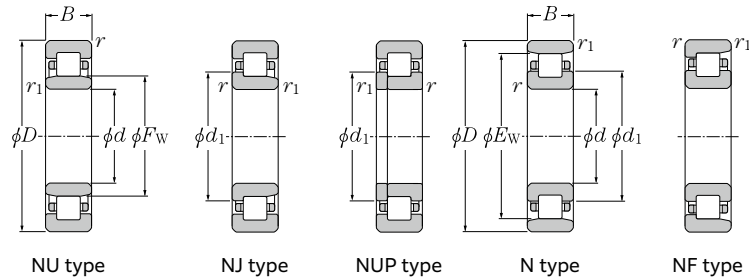

d 130 ~ 160mm

	Boundary dimensions				Basic load rating		Fatigue load limit kN C _u	Allowable speed ²⁾		Bearing number			
	mm				dynamic	static		min ⁻¹					
	d	D	B	r _{s min¹⁾}	r _{1s min¹⁾}	C _r		C _{0r}	Grease lubrication	Oil lubrication	NU type	NJ type	NUP type
130	230	40	3	3	300	340	35.0	2 900	3 400	NU226	NJ	NUP	N
	230	40	3	3	405	455	46.0	2 600	3 100	NU226E	NJ	NUP	—
	230	64	3	3	420	530	54.0	2 600	3 100	NU2226	NJ	NUP	N
	230	64	3	3	590	735	75.0	2 300	2 700	NU2226E	NJ	NUP	—
	280	58	4	4	620	665	65.5	2 500	2 900	NU326	NJ	NUP	N
	280	58	4	4	685	735	72.0	2 200	2 600	NU326E	NJ	NUP	—
	280	93	4	4	930	1 130	111	2 200	2 600	NU2326	NJ	NUP	N
	280	93	4	4	1 020	1 230	121	2 000	2 300	NU2326E	NJ	NUP	—
140	210	33	2	1.1	195	250	25.7	3 200	3 800	NU1028	NJ	NUP	N
	250	42	3	3	345	400	39.5	2 700	3 100	NU228	NJ	NUP	N
	250	42	3	3	435	515	51.0	2 400	2 800	NU228E	NJ	NUP	—
	250	68	3	3	495	635	63.5	2 400	2 800	NU2228	NJ	NUP	N
	250	68	3	3	635	835	83.0	2 100	2 500	NU2228E	NJ	NUP	—
	300	62	4	4	685	745	72.0	2 300	2 700	NU328	NJ	NUP	N
	300	62	4	4	735	795	76.5	2 100	2 400	NU328E	NJ	NUP	—
	300	102	4	4	1 020	1 250	120	2 000	2 300	NU2328	NJ	NUP	N
	300	102	4	4	1 130	1 380	133	1 800	2 100	NU2328E	NJ	NUP	—
150	225	35	2.1	1.5	224	294	29.6	3 000	3 500	NU1030	NJ	NUP	N
	270	45	3	3	380	435	42.5	2 500	2 900	NU230	NJ	NUP	N
	270	45	3	3	495	595	58.0	2 200	2 600	NU230E	NJ	NUP	—
	270	73	3	3	555	710	69.5	2 200	2 600	NU2230	NJ	NUP	N
	270	73	3	3	735	980	95.5	2 000	2 400	NU2230E	NJ	NUP	—
	320	65	4	4	735	805	76.0	2 100	2 500	NU330	NJ	NUP	N
	320	65	4	4	840	920	86.5	1 900	2 300	NU330E	NJ	NUP	—
	320	108	4	4	1 130	1 400	132	1 900	2 200	NU2330	NJ	NUP	N
	320	108	4	4	1 290	1 600	150	1 700	2 000	NU2330E	NJ	NUP	—
160	240	38	2.1	1.5	263	340	34.0	2 800	3 300	NU1032	NJ	NUP	N
	290	48	3	3	475	570	54.5	2 300	2 700	NU232	NJ	NUP	N
	290	48	3	3	555	665	63.5	2 100	2 400	NU232E	NJ	NUP	—
	290	80	3	3	700	940	90.0	2 100	2 400	NU2232	NJ	NUP	N
	290	80	3	3	895	1 190	114	1 900	2 200	NU2232E	NJ	NUP	—
	340	68	4	4	775	875	81.0	2 000	2 300	NU332	NJ	NUP	N
	340	68	4	4	950	1 050	97.5	1 800	2 100	NU332E	NJ	NUP	—
	340	114	4	4	1 190	1 520	141	1 700	2 000	NU2332	NJ	NUP	N
	340	114	4	4	1 460	1 820	168	1 600	1 900	NU2332E	NJ	NUP	—

1) Smallest allowable dimension for chamfer dimension r or r₁.

2) This value is for machined cages; when pressed cages are used, 80% of this value is acceptable.

Cylindrical Roller Bearings

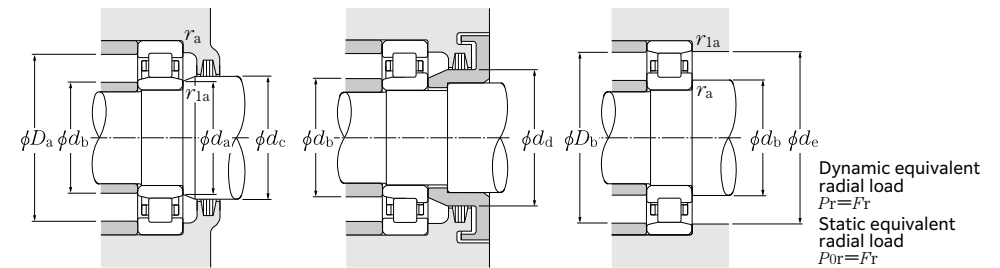

	Dimension				Installation-related dimensions								Mass		
	mm				mm								kg		
	NF type	F _w	E _w	d ₁	d _a Min.	d _e Min.	d _b Max.	d _c Min.	d _d Min.	D _a Max.	D _b Max.	r _{as} Min. ³⁾	r _{1as} Max.	NU type (approx.)	N type (approx.)
NF	156	204	165.5	143	143	151	158	168	217	217	208	2.5	2.5	6.3	6.17
—	153.5	—	164.7	143	—	151	158	168	217	—	—	2.5	2.5	6.9	—
—	156	204	165.5	143	143	151	158	168	217	217	208	2.5	2.5	10.2	10
—	153.5	—	164.7	143	—	151	158	168	217	—	—	2.5	2.5	11.8	—
NF	167	243	182	146	146	164	169	184	264	264	247	3	3	17.4	17
—	167	—	183	146	—	164	169	184	264	—	—	3	3	19.4	—
—	167	243	182	146	146	164	169	184	264	264	247	3	3	26.9	26.4
—	167	—	183	146	—	164	169	184	264	—	—	3	3	30.9	—
—	158	192	164.8	146.5	149	156	161	166	201	203.5	194	2	1	4.05	3.98
NF	169	221	179.5	153	153	166	171	182	237	237	225	2.5	2.5	7.88	7.72
—	169	—	180.2	153	—	166	171	182	237	—	—	2.5	2.5	8.73	—
—	169	221	179.5	153	153	166	171	182	237	237	225	2.5	2.5	12.9	12.6
—	169	—	180.2	153	—	166	171	182	237	—	—	2.5	2.5	15.8	—
NF	180	260	196	156	156	176	182	198	284	284	265	3	3	21.2	20.7
—	180	—	196.8	156	—	176	182	198	284	—	—	3	3	23.2	—
—	180	260	196	156	156	176	182	198	284	284	265	3	3	33.8	33.1
—	180	—	196.8	156	—	176	182	198	284	—	—	3	3	38.7	—
—	169.5	205.5	176.7	158	161	167	173	178	214	217	207.5	2	1.5	4.77	4.7
NF	182	238	193	163	163	179	184	196	257	257	242	2.5	2.5	9.92	9.72
—	182	—	194	163	—	179	184	196	257	—	—	2.5	2.5	11	—
—	182	238	193	163	163	179	184	196	257	257	242	2.5	2.5	16.3	16
—	182	—	194	163	—	179	184	196	257	—	—	2.5	2.5	19.7	—
NF	193	277	210	166	166	190	195	213	304	304	282	3	3	25.3	24.7
—	193	—	211	166	—	190	195	213	304	—	—	3	3	28.4	—
—	193	277	210	166	166	190	195	213	304	304	282	3	3	40.6	39.8
—	193	—	211	166	—	190	195	213	304	—	—	3	3	47.2	—
—	180	220	188	168	171	178	184	189	229	232	222	2	1.5	5.9	5.81
NF	195	255	207	173	173	192	197	210	277	277	259	2.5	2.5	13.7	13.4
—	195	—	207.8	173	—	192	197	210	277	—	—	2.5	2.5	15.6	—
—	195	255	207	173	173	192	197	210	277	277	259	2.5	2.5	22	21.6
—	193	—	206.6	173	—	192	197	210	277	—	—	2.5	2.5	25.1	—
NF	208	292	225	176	176	200	211	228	324	324	297	3	3	31.3	30.6
—	204	—	223.2	176	—	200	211	228	324	—	—	3	3	34	—
—	208	292	225	176	176	200	211	228	324	324	297	3	3	50.5	49.5
—	204	—	223.2	176	—	200	211	228	324	—	—	3	3	56	—

3) Does not apply to the sides of the outer ring rib of type NF bearings.

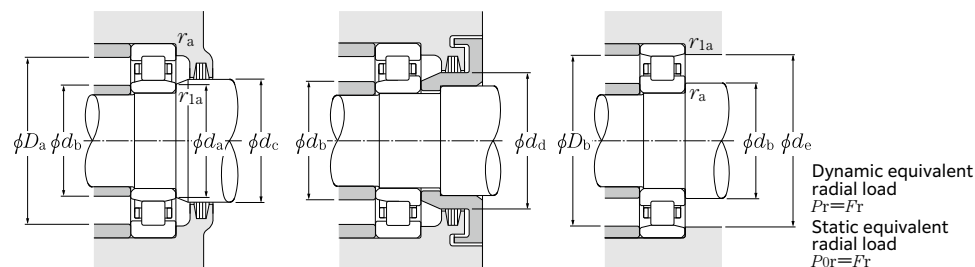
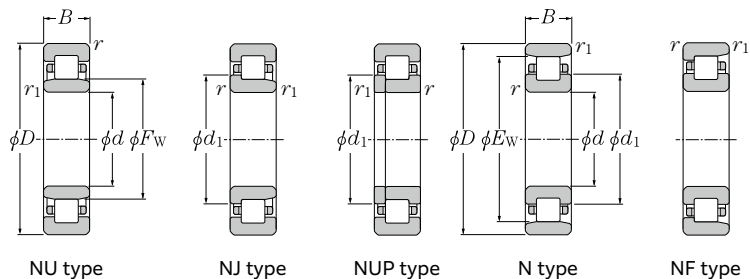

d 170 ~ 220mm

d	Boundary dimensions				Basic load rating		Fatigue load limit kN Cu	Allowable speed ²⁾		Bearing number			
	D	B	rs min ¹⁾	r1s min ¹⁾	dynamic kN Cr	static kN C0r		Grease lubrication	Oil lubrication	NU type	NJ type	NUP type	N type
170	260	42	2.1	2.1	310	400	38.5	2 600	3 000	NU1034	NJ	NUP	N
	310	52	4	4	530	635	59.5	2 200	2 500	NU234	NJ	NUP	N
	310	52	4	4	670	800	75.0	2 000	2 300	NU234E	NJ	NUP	—
	310	86	4	4	795	1 080	101	2 000	2 300	NU2234	NJ	NUP	N
	310	86	4	4	1 070	1 410	132	1 800	2 100	NU2234E	NJ	NUP	—
	360	72	4	4	885	1 010	92.0	1 800	2 200	NU334	NJ	NUP	N
	360	120	4	4	1 360	1 750	159	1 600	1 900	NU2334	NJ	NUP	N
180	280	46	2.1	2.1	380	485	46.5	2 400	2 900	NU1036	NJ	NUP	N
	320	52	4	4	550	675	62.5	2 000	2 400	NU236	NJ	NUP	N
	320	52	4	4	695	850	78.5	1 800	2 200	NU236E	NJ	NUP	—
	320	86	4	4	825	1 140	106	1 800	2 200	NU2236	NJ	NUP	N
	320	86	4	4	1 120	1 510	139	1 600	1 900	NU2236E	NJ	NUP	—
	380	75	4	4	1 000	1 150	103	1 700	2 000	NU336	NJ	NUP	N
	380	126	4	4	1 530	1 990	179	1 500	1 800	NU2336	NJ	NUP	N
190	290	46	2.1	2.1	390	510	48.0	2 300	2 700	NU1038	NJ	NUP	N
	340	55	4	4	615	770	70.0	1 900	2 200	NU238	NJ	NUP	N
	340	55	4	4	770	955	86.5	1 700	2 000	NU238E	NJ	NUP	—
	340	92	4	4	920	1 290	117	1 700	2 000	NU2238	NJ	NUP	N
	340	92	4	4	1 220	1 670	152	1 500	1 800	NU2238E	NJ	NUP	—
	400	78	5	5	1 080	1 260	111	1 600	1 900	NU338	NJ	NUP	N
	400	132	5	5	1 680	2 220	196	1 400	1 700	NU2338	NJ	NUP	N
200	310	51	2.1	2.1	430	580	53.5	2 200	2 600	NU1040	NJ	NUP	N
	360	58	4	4	690	865	77.5	1 800	2 100	NU240	NJ	NUP	N
	360	58	4	4	850	1 060	95.0	1 600	1 900	NU240E	NJ	NUP	—
	360	98	4	4	1 020	1 440	129	1 600	1 900	NU2240	NJ	NUP	N
	360	98	4	4	1 350	1 870	167	1 500	1 700	NU2240E	NJ	NUP	—
	420	80	5	5	1 080	1 270	111	1 500	1 800	NU340	NJ	NUP	N
	420	138	5	5	1 680	2 240	195	1 400	1 600	NU2340	NJ	NUP	N
220	340	56	3	3	555	750	67.0	2 000	2 300	NU1044	NJ	NUP	N
	400	65	4	4	845	1 080	94	1 600	1 900	NU244	NJ	NUP	N
	400	108	4	4	1 260	1 810	157	1 500	1 700	NU2244	NJ	NUP	N
	460	88	5	5	1 320	1 570	133	1 400	1 600	NU344	NJ	NUP	N
	460	145	5	5	1 970	2 620	222	1 200	1 400	NU2344	NJ	NUP	N

1) Smallest allowable dimension for chamfer dimension r or r1.

2) This value is for machined cages; when pressed cages are used, 80% of this value is acceptable.

NF type	Dimension				Installation-related dimensions										Mass	
	Fw	Ew	d1	mm	da	de	db	dc	dd	Da	Db	ras	r1as	NU type	N type	
—	193	237	201.8	181	181	190	197	203	249	249	239	2	2	7.88	7.76	
NF	208	272	220.5	186	186	204	211	223	294	294	277	3	3	17	16.7	
—	207	—	221.4	186	—	204	211	223	294	—	—	3	3	19.6	—	
—	208	272	220.5	186	186	204	211	223	294	294	277	3	3	27.2	26.7	
—	205	—	220.2	186	—	204	211	223	294	—	—	3	3	31	—	
NF	220	310	238	186	186	216	223	241	344	344	315	3	3	37	36.1	
—	220	310	238	186	186	216	223	241	344	344	315	3	3	59.5	58.3	
—	205	255	215	191	191	203	209	216	269	269	257	2	2	10.3	10.1	
NF	218	282	230.5	196	196	214	221	233	304	304	287	3	3	17.7	17.3	
—	217	—	231.4	196	—	214	221	233	304	—	—	3	3	20.4	—	
—	218	282	230.5	196	196	214	221	233	304	304	287	3	3	28.4	27.8	
—	215	—	230.2	196	—	214	221	233	304	—	—	3	3	31.9	—	
NF	232	328	252	196	196	227	235	255	364	364	333	3	3	44.2	43.2	
—	232	328	252	196	196	227	235	255	364	364	333	3	3	69.5	68.1	
—	215	265	225	201	201	213	219	226	279	279	267	2	2	10.7	10.5	
NF	231	299	244.5	206	206	227	234	247	324	324	304	3	3	21.3	20.8	
—	230	—	245.2	206	—	227	234	247	324	—	—	3	3	24.2	—	
—	231	299	244.5	206	206	227	234	247	324	324	304	3	3	34.4	33.7	
—	228	—	244	206	—	227	234	247	324	—	—	3	3	39.5	—	
NF	245	345	265	210	210	240	248	268	380	380	351	4	4	49.4	48.3	
—	245	345	265	210	210	240	248	268	380	380	351	4	4	80.5	78.9	
—	229	281	239.4	211	211	226	233	241	299	299	283	2	2	13.9	13.7	
NF	244	316	258	216	216	240	247	261	344	344	321	3	3	25.3	24.8	
—	243	—	259	216	—	240	247	261	344	—	—	3	3	28.1	—	
—	244	316	258	216	216	240	247	261	344	344	321	3	3	41.3	40.5	
—	241	—	257.8	216	—	240	247	261	344	—	—	3	3	47.8	—	
NF	260	360	280	220	220	254	263	283	400	400	366	4	4	55.8	54.5	
—	260	360	280	220	220	254	263	283	400	400	366	4	4	92.6	90.7	
—	250	310	262	233	233	248	254	264	327	327	313	2.5	2.5	18.2	17.9	
NF	270	350	286	236	236	266	273	289	384	384	355	3	3	37.7	37	
—	270	350	286	236	236	266	273	289	384	384	355	3	3	59	57.8	
NF	284	396	307	240	240	279	287	307	440	440	402	4	4	73.4	71.7	
—	284	396	307	240	240	279	287	307	440	440	402	4	4	116	114	

3) Does not apply to the sides of the outer ring rib of type NF bearings.

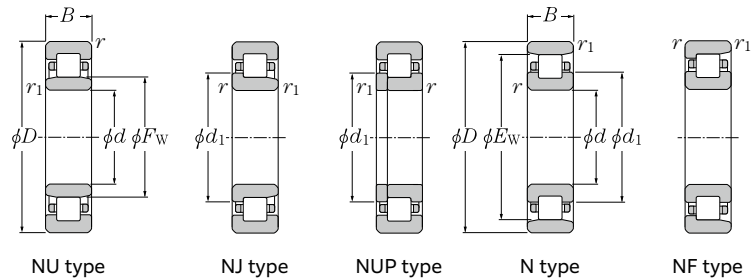

d 240 ~ 440mm

d	Boundary dimensions			Basic load rating		Fatigue load limit kN C _u	Allowable speed ²⁾		Bearing number				
	D	B	r _s min ¹⁾	r _{1s} min ¹⁾	C _r		C _{0r}	Grease lubrication	Oil lubrication	NU type	NJ type	NUP type	N type
240	360	56	3	3	585	820	72.0	1 800	2 100	NU1048	NJ	NUP	N
	440	72	4	4	1 040	1 340	113	1 500	1 700	NU248	NJ	NUP	N
	440	120	4	4	1 590	2 320	196	1 300	1 600	NU2248	NJ	NUP	N
	500	95	5	5	1 590	1 950	160	1 300	1 500	NU348	NJ	NUP	N
	500	155	5	5	2 330	3 200	262	1 100	1 300	NU2348	NJ	NUP	N
260	400	65	4	4	715	1 000	85.0	1 600	1 900	NU1052	NJ	NUP	N
	480	80	5	5	1 270	1 660	137	1 300	1 600	NU252	NJ	NUP	N
	480	130	5	5	1 980	2 930	241	1 200	1 400	NU2252	NJ	NUP	N
	540	102	6	6	1 790	2 230	180	1 200	1 400	NU352	NJ	NUP	N
	540	165	6	6	2 600	3 600	289	1 000	1 200	NU2352	NJ	NUP	N
280	420	65	4	4	730	1 050	88.0	1 500	1 800	NU1056	NJ	NUP	N
	500	80	5	5	1 320	1 760	143	1 200	1 400	NU256	NJ	NUP	N
	500	130	5	5	2 050	3 100	252	1 100	1 300	NU2256	NJ	NUP	N
	580	108	6	6	2 010	2 540	200	1 100	1 200	NU356	NJ	NUP	N
	580	175	6	6	3 000	4 250	335	920	1 100	NU2356	NJ	NUP	N
300	460	74	4	4	950	1 340	109	1 400	1 600	NU1060	NJ	NUP	N
	540	85	5	5	1 560	2 070	164	1 100	1 300	NU260	NJ	NUP	N
	540	140	5	5	2 420	3 650	290	1 000	1 200	NU2260	NJ	NUP	N
320	480	74	4	4	970	1 410	113	1 300	1 500	NU1064	NJ	NUP	N
	580	92	5	5	1 780	2 390	186	1 000	1 200	NU264	NJ	NUP	N
	580	150	5	5	2 830	4 350	340	950	1 100	NU2264	NJ	NUP	N
340	520	82	5	5	1 160	1 670	132	1 200	1 400	NU1068	NJ	NUP	N
360	540	82	5	5	1 190	1 750	136	1 100	1 300	NU1072	NJ	NUP	N
380	560	82	5	5	1 220	1 840	141	1 100	1 200	NU1076	NJ	NUP	N
400	600	90	5	5	1 460	2 190	164	990	1 200	NU1080	NJ	NUP	N
420	620	90	5	5	1 500	2 290	170	950	1 100	NU1084	NJ	NUP	N
440	650	94	6	6	1 590	2 430	178	900	1 100	NU1088	NJ	NUP	N

1) Smallest allowable dimension for chamfer dimension r or r₁.

2) This value is for machined cages; when pressed cages are used, 80% of this value is acceptable.

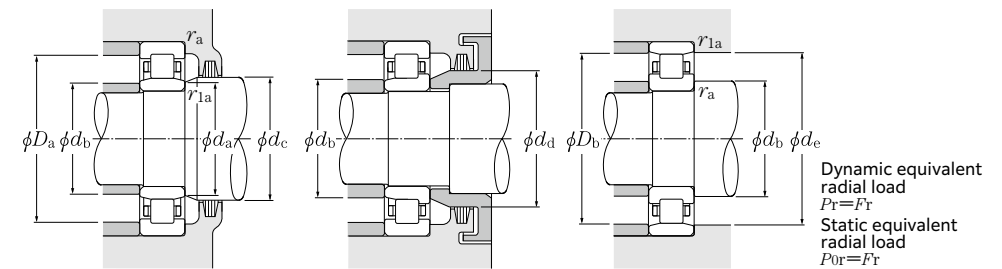

Dynamic equivalent radial load
P_r = F_r
Static equivalent radial load
P_{0r} = F_r

NF type	Dimension			Installation-related dimensions										Mass	
	F _w	E _w	d ₁	d _a Min.	d _e Min.	d _b Max.	d _c Min.	d _d Min.	D _a Max.	D _b Max.	D _b Min. ³⁾	r _{as} Max.	r _{1as} Max.	NU type (approx.)	N type
—	270	330	282	253	253	268	275	284	347	347	333	2.5	2.5	19.6	19.3
NF	295	385	313	256	256	293	298	316	424	424	390	3	3	50.2	49.2
—	295	385	313	256	256	293	298	316	424	424	390	3	3	80	78.4
NF	310	430	335	260	260	305	313	333	480	480	436	4	4	93.4	91.3
—	310	430	335	260	260	305	313	333	480	480	436	4	4	147	144
—	296	364	309.6	276	276	292	300	312	384	384	367	3	3	29.1	28.7
NF	320	420	340	280	280	318	323	343	460	460	426	4	4	66.9	65.6
—	320	420	340	280	280	318	323	343	460	460	426	4	4	104	102
NF	336	464	362	284	284	331	339	359	516	516	471	5	5	117	114
—	336	464	362	284	284	331	339	359	516	516	471	5	5	182	178
—	316	384	329.6	296	296	312	320	332	404	404	387	3	3	30.9	30.4
NF	340	440	360	300	300	336	343	365	480	480	446	4	4	70.8	69.4
—	340	440	360	300	300	336	343	365	480	480	446	4	4	109	107
NF	362	498	390	304	304	356	366	386	556	556	505	5	5	142	139
—	362	498	390	304	304	356	366	386	556	556	505	5	5	222	218
—	340	420	356	316	316	336	344	358	444	444	423	3	3	43.6	42.9
NF	364	476	387	320	320	361	368	392	520	520	482	4	4	88.2	86.4
—	364	476	387	320	320	361	368	392	520	520	482	4	4	138	135
—	360	440	376	336	336	356	364	378	464	464	443	3	3	46	45.3
NF	390	510	415	340	340	386	393	419	560	560	516	4	4	111	109
—	390	510	415	340	340	386	393	419	560	560	516	4	4	172	168
—	385	475	403	360	360	381	390	405	500	500	479	4	4	61.8	60.8
—	405	495	423	380	380	401	410	425	520	520	499	4	4	64.7	63.7
—	425	515	443	400	400	421	430	445	540	540	519	4	4	67.5	66.5
—	450	550	470	420	420	446	455	473	580	580	554	4	4	87.6	86.3
—	470	570	490	440	440	466	475	493	600	600	574	4	4	91	89.6
—	493	597	513.8	464	464	488	499	517	626	626	602	5	5	105	103

3) Does not apply to the sides of the outer ring rib of type NF bearings.

Cylindrical Roller Bearings

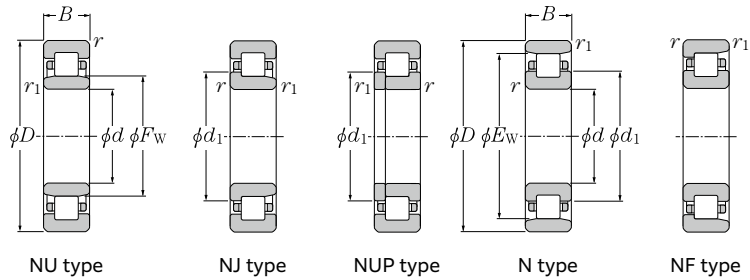

d 460 ~ 500mm

d	Boundary dimensions					Basic load rating		Fatigue load limit kN C_u	Allowable speed ²⁾		Bearing number				
	D	B	r_s min ¹⁾	r_{1s} min ¹⁾	mm	dynamic kN C_r	static kN C_{0r}		Grease lubrication	Oil lubrication	min ⁻¹	min ⁻¹	NU type	NJ type	NUP type
460	680	100	6	6	1 710	2 630	191	850	1 000			NU1092	NJ	NUP	N
480	700	100	6	6	1 750	2 750	197	810	960			NU1096	NJ	NUP	N
500	720	100	6	6	1 790	2 870	203	770	910			NU10/500	NJ	NUP	N

1) Smallest allowable dimension for chamfer dimension r or r_1 .
2) This value is for machined cages; when pressed cages are used, 80% of this value is acceptable.

Cylindrical Roller Bearings

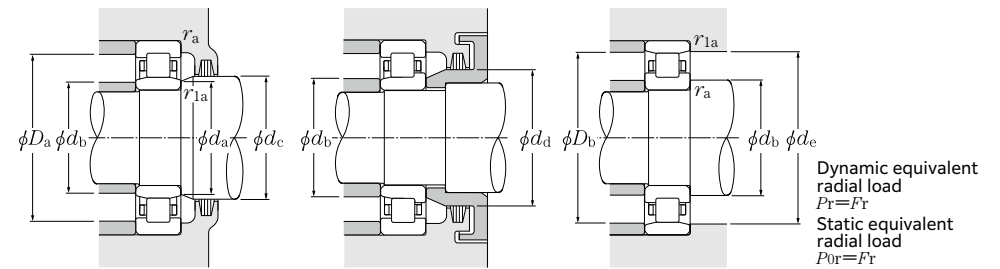

NF type	Dimension					Installation-related dimensions								Mass	
	F_w	E_w	d_1	d_a Min.	d_e Min.	d_b Max.	d_c Min.	d_d Min.	mm D_a Max.	D_b Max.	D_b Min. ³⁾	r_{as} Max.	r_{1as} Max.	kg NU type (approx.)	kg N type (approx.)
—	516	624	537.6	484	484	511	522	541	656	656	629	5	5	122	120
—	536	644	557.6	504	504	531	542	561	676	676	649	5	5	126	124
—	556	664	577.6	524	524	551	562	581	696	696	669	5	5	130	128

3) Does not apply to the sides of the outer ring rib of type NF bearings.

L type collar ring

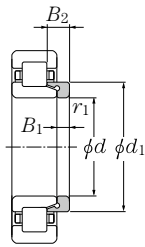

NH=NJ+HJ

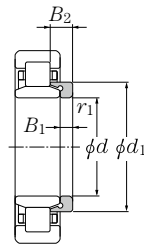

NUJ=NU+HJ

d 20 ~ 60mm

d	Dimension mm				L type collar ring number	Mass kg (approx.)
	d ₁	B ₁	B ₂	r _{1s} min ¹⁾		
20	29.9	3	6.75	0.6	HJ204	0.012
	29.5	3	5.5	0.6	HJ204E	0.009
	29.9	3	7.5	0.6	HJ2204	0.013
	29.5	3	6.5	0.6	HJ2204E	0.01
	31.8	4	7.5	0.6	HJ304	0.017
	31.1	4	6.5	0.6	HJ304E	0.014
	31.8	4	8.5	0.6	HJ2304	0.018
31.1	4	7.5	0.6	HJ2304E	0.015	
25	34.8	3	7.25	0.6	HJ205	0.015
	34.5	3	6	0.6	HJ205E	0.012
	34.8	3	7.5	0.6	HJ2205	0.015
	34.5	3	6.5	0.6	HJ2205E	0.013
	39	4	8	1.1	HJ305	0.025
	38	4	7	1.1	HJ305E	0.021
	39	4	9	1.1	HJ2305	0.027
38	4	8	1.1	HJ2305E	0.024	
43.6	6	10.5	1.5	HJ405	0.057	
30	41.7	4	8.25	0.6	HJ206	0.025
	41.1	4	7	0.6	HJ206E	0.017
	41.7	4	8.5	0.6	HJ2206	0.025
	41.1	4	7.5	0.6	HJ2206E	0.02
	45.9	5	9.5	1.1	HJ306	0.039
	44.9	5	8.5	1.1	HJ306E	0.035
	45.9	5	11.5	1.1	HJ2306	0.043
44.9	5	9.5	1.1	HJ2306E	0.035	
50.5	7	11.5	1.5	HJ406	0.08	
35	47.6	4	8	0.6	HJ207	0.03
	48	4	7	0.6	HJ207E	0.027
	47.6	4	8.5	0.6	HJ2207	0.031
	48	4	8.5	0.6	HJ2207E	0.031
	50.8	6	11	1.1	HJ307	0.056
	51	6	9.5	1.1	HJ307E	0.048
	50.8	6	14	1.1	HJ2307	0.064
51	6	11	1.1	HJ2307E	0.055	
59	8	13	1.5	HJ407	0.12	

d	Dimension mm				L type collar ring number	Mass kg (approx.)
	d ₁	B ₁	B ₂	r _{1s} min ¹⁾		
40	54.2	5	9	1.1	HJ208	0.046
	53.9	5	8.5	1.1	HJ208E	0.042
	54.2	5	9.5	1.1	HJ2208	0.047
	53.9	5	9	1.1	HJ2208E	0.045
	58.4	7	12.5	1.5	HJ308	0.083
	57.6	7	11	1.5	HJ308E	0.07
	58.4	7	14.5	1.5	HJ2308	0.09
57.6	7	12.5	1.5	HJ2308E	0.08	
64.8	8	13	2	HJ408	0.14	
45	59	5	9.5	1.1	*HJ209	0.053
	58.9	5	8.5	1.1	HJ209E	0.047
	58.9	5	9	1.1	HJ2209E	0.05
	64	7	12.5	1.5	HJ309	0.099
	64.5	7	11.5	1.5	HJ309E	0.093
	64	7	15	1.5	HJ2309	0.109
	64.5	7	13	1.5	HJ2309E	0.103
71.8	8	13.5	2	HJ409	0.175	
50	64.6	5	10	1.1	HJ210	0.063
	63.9	5	9	1.1	*HJ210E	0.055
	64.6	5	9.5	1.1	HJ2210	0.061
	71	8	14	2	HJ310	0.142
	71.4	8	13	2	HJ310E	0.134
	71	8	17	2	HJ2310	0.157
	71.4	8	14.5	2	HJ2310E	0.15
78.8	9	14.5	2.1	HJ410	0.23	
55	70.8	6	11	1.1	*HJ211	0.084
	70.8	6	9.5	1.1	HJ211E	0.072
	70.8	6	10	1.1	HJ2211E	0.076
	77.2	9	15	2	HJ311	0.182
	77.7	9	14	2	HJ311E	0.168
	77.2	9	18.5	2	HJ2311	0.203
	77.7	9	15.5	2	HJ2311E	0.185
85.2	10	16.5	2.1	HJ411	0.29	
60	78.4	6	11	1.5	*HJ212	0.108
	77.6	6	10	1.5	*HJ212E	0.094

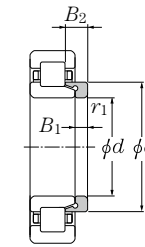

NH=NJ+HJ

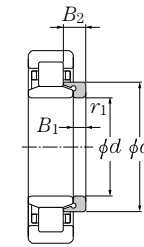

NUJ=NU+HJ

d 60 ~ 105mm

d	Dimension mm				L type collar ring number	Mass kg (approx.)
	d ₁	B ₁	B ₂	r _{1s} min ¹⁾		
60	84.2	9	15.5	2.1	HJ312	0.22
	84.6	9	14.5	2.1	HJ312E	0.205
	84.2	9	19	2.1	HJ2312	0.245
	84.6	9	16	2.1	HJ2312E	0.23
	91.8	10	16.5	2.1	HJ412	0.34
65	84.8	6	11	1.5	HJ213	0.123
	84.5	6	10	1.5	HJ213E	0.111
	84.8	6	11.5	1.5	HJ2213	0.126
	84.5	6	10.5	1.5	HJ2213E	0.118
	91	10	17	2.1	HJ313	0.28
70	91	10	15.5	2.1	HJ313E	0.25
	91	10	20	2.1	HJ2313	0.304
	91	10	18	2.1	HJ2313E	0.29
	98.5	11	18	2.1	HJ413	0.42
	75	89.6	7	12.5	1.5	*HJ214
89.5		7	11	1.5	HJ214E	0.13
89.5		7	11.5	1.5	HJ2214E	0.138
98		10	17.5	2.1	HJ314	0.33
98		10	15.5	2.1	HJ314E	0.293
80	98	10	20.5	2.1	HJ2314	0.358
	98	10	18.5	2.1	HJ2314E	0.35
	110.5	12	20	3	HJ414	0.605
	94	7	12.5	1.5	*HJ215	0.156
	94.5	7	11	1.5	HJ215E	0.141
85	94.5	7	11.5	1.5	HJ2215E	0.164
	104.2	11	18.5	2.1	HJ315	0.4
	104.6	11	16.5	2.1	HJ315E	0.35
	104.2	11	21.5	2.1	HJ2315	0.432
	104.6	11	19.5	2.1	HJ2315E	0.41
90	116	13	21.5	3	HJ415	0.71
	101.2	8	13.5	2	*HJ216	0.207
	101.7	8	12.5	2	*HJ216E	0.193
	111.8	11	19.5	2.1	HJ316	0.47
	111	11	17	2.1	HJ316E	0.405
95	111.8	11	23	2.1	HJ2316	0.511
	121	9	15.5	2.1	HJ219	0.352
	121	9	14	2.1	HJ219E	0.304
	121	9	16.5	2.1	HJ2219	0.363
	121	9	15.5	2.1	HJ2219E	0.335
100	132	13	22.5	3	HJ319	0.76
	132.7	13	20.5	3	HJ319E	0.7
	132	13	26.5	3	HJ2319	0.826
	132.7	13	24.5	3	HJ2319E	0.8
	105	128	10	17	2.1	HJ220
128		10	15	2.1	HJ220E	0.38
128		10	18	2.1	HJ2220	0.456
128		10	16	2.1	HJ2220E	0.385
140.5		13	22.5	3	HJ320	0.895
110	140.3	13	20.5	3	HJ320E	0.8
	140.5	13	27.5	3	HJ2320	0.986
	140.3	13	23.5	3	HJ2320E	0.92
	140.5	13	25	3	HJ2320E	0.92
	140.5	13	27.5	3	HJ2320E	0.92
115	135	10	17.5	2.1	HJ221	0.505

1) Smallest allowable dimension for chamfer dimension r. Note: 1 This L type collar ring is used with NU type cylindrical roller bearings; in duplex arrangements with NJ or NU type bearing numbers, they become NH type and NUJ type respectively. Refer to pages B-98 to B-101 for bearing dimensions, allowable rotations, and mass. 2. "*" indicates L type collar rings that can also be used with dimension series 22 bearings.

1) Smallest allowable dimension for chamfer dimension r. Note: 1 This L type collar ring is used with NU type cylindrical roller bearings; in duplex arrangements with NJ or NU type bearing numbers, they become NH type and NUJ type respectively. Refer to pages B-102 to B-107 for bearing dimensions, allowable rotations, and mass. 2. "*" indicates L type collar rings that can also be used with dimension series 22 bearings.

L type collar ring

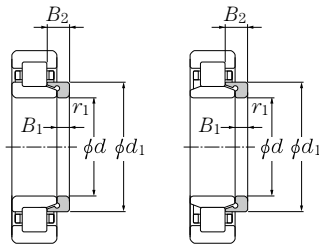

NH=NJ+HJ

NUJ=NU+HJ

d 105 ~ 200mm

d	Dimension mm				L type collar ring number	Mass kg (approx.)
	d ₁	B ₁	B ₂	r _{1s} min ¹⁾		
105	147	13	22.5	3	HJ321	0.97
110	141.5	11	18.5	2.1	HJ222	0.615
	142.1	11	17	2.1	HJ222E	0.553
	141.5	11	20.5	2.1	HJ2222	0.645
	142.1	11	19.5	2.1	HJ2222E	0.605
	155.5	14	23	3	HJ322	1.17
	156.6	14	22	3	HJ322E	1.09
120	155.5	14	28	3	HJ2322	1.28
	156.6	14	26.5	3	HJ2322E	1.25
	153	11	19	2.1	HJ224	0.715
	153.9	11	17	2.1	HJ224E	0.634
	153	11	22	2.1	HJ2224	0.767
	153.9	11	20	2.1	HJ2224E	0.705
130	168.5	14	23.5	3	HJ324	1.4
	169.2	14	22.5	3	HJ324E	1.28
	168.5	14	28	3	HJ2324	1.53
	169.2	14	26	3	HJ2324E	1.42
	165.5	11	19	3	HJ226	0.84
	164.7	11	17	3	HJ226E	0.684
140	165.5	11	25	3	HJ2226	0.953
	164.7	11	21	3	HJ2226E	0.831
	182	14	24	4	HJ326	1.62
	183	14	23	4	HJ326E	1.53
	182	14	29.5	4	HJ2326	1.8
	183	14	28	4	HJ2326E	1.75
150	179.5	11	19	3	HJ228	1
	180.2	11	18	3	HJ228E	0.929
	179.5	11	25	3	HJ2228	1.14
	180.2	11	23	3	HJ2228E	1.11
	196	15	26	4	HJ328	1.93
	196.8	15	25	4	HJ328E	1.91

150 193 12 20.5 3 **HJ230** 1.24

1) Smallest allowable dimension for chamfer dimension r.

Note: 1 This L type collar ring is used with NU type cylindrical roller bearings; in duplex arrangements with NJ or NU type bearing numbers, they become NH type and NUJ type respectively. Refer to pages B-106 to B-111 for bearing dimensions, allowable rotations, and mass.

d	Dimension mm				L type collar ring number	Mass kg (approx.)
	d ₁	B ₁	B ₂	r _{1s} min ¹⁾		
150	194	12	19.5	3	HJ230E	1.18
	193	12	26.5	3	HJ2230	1.39
	194	12	24.5	3	HJ2230E	1.42
	210	15	26.5	4	HJ330	2.37
	211	15	25	4	HJ330E	2.25
	210	15	34	4	HJ2330	2.69
160	211	15	31.5	4	HJ2330E	2.6
	207	12	21	3	HJ232	1.48
	207.8	12	20	3	HJ232E	1.34
	207	12	28	3	HJ2232	1.69
	206.6	12	24.5	3	HJ2232E	1.61
	225	15	28	4	HJ332	2.75
170	223.2	15	25	4	HJ332E	2.4
	225	15	37	4	HJ2332	3.16
	223.2	15	32	4	HJ2332E	2.85
	220.5	12	22	4	HJ234	1.7
	221.4	12	20	4	HJ234E	1.51
	220.5	12	29	4	HJ2234	1.93
180	220.2	12	24	4	HJ2234E	1.82
	238	16	29.5	4	HJ334	3.25
	238	16	38.5	4	HJ2334	3.71
	230.5	12	22	4	HJ236	1.8
	231.4	12	20	4	HJ236E	1.7
	230.5	12	29	4	HJ2236	2.04
190	230.2	12	24	4	HJ2236E	1.91
	252	17	30.5	4	HJ336	3.85
	252	17	40	4	HJ2336	4.42
	244.5	13	23.5	4	HJ238	2.2
	245.2	13	21.5	4	HJ238E	1.94
	244.5	13	31.5	4	HJ2238	2.52
200	244	13	26.5	4	HJ2238E	2.38
	265	18	32	5	HJ338	4.45
	265	18	41.5	5	HJ2338	5.05
	258	14	25	4	HJ240	2.6

200 258 14 25 4 **HJ240** 2.6

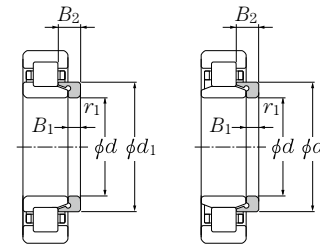

NH=NJ+HJ

NUJ=NU+HJ

d 200 ~ 320mm

d	Dimension mm				L type collar ring number	Mass kg (approx.)
	d ₁	B ₁	B ₂	r _{1s} min ¹⁾		
200	259	14	23	4	HJ240E	2.35
	258	14	34	4	HJ2240	2.99
	257.8	14	28	4	HJ2240E	2.86
	280	18	33	5	HJ340	5
	280	18	44.5	5	HJ2340	5.76
	220	286	15	27.5	4	HJ244
307		20	36	5	HJ344	7.05
240	313	16	29.5	4	HJ248	4.65
	335	22	39.5	5	HJ348	8.2
260	340	18	33	5	HJ252	6.2
	362	24	43	6	HJ352	11.4
280	360	18	33	5	HJ256	7.39
	390	26	46	6	HJ356	13.9
300	387	20	34.5	5	HJ260	9.14
320	415	21	37	5	HJ264	11.3

1) Smallest allowable dimension for chamfer dimension r.

Note: 1 This L type collar ring is used with NU type cylindrical roller bearings; in duplex arrangements with NJ or NU type bearing numbers, they become NH type and NUJ type respectively. Refer to pages B-110 to B-113 for bearing dimensions, allowable rotations, and mass.

● Double Row Cylindrical Roller Bearings

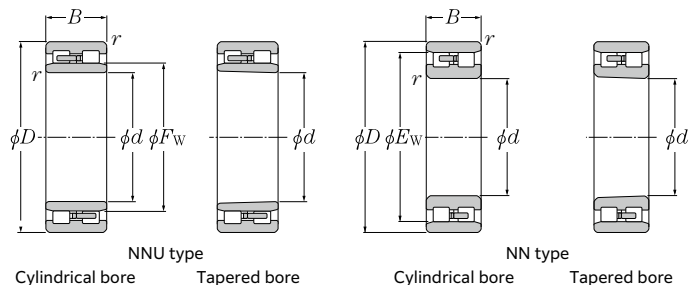

d 25 ~ 110mm

d	Boundary dimensions			Basic load rating		Fatigue load limit kN C _u	Allowable speed		Bearing number ²⁾	
	D	B	r _{s min} ¹⁾	dynamic kN C _r	static kN C _{0r}		min ⁻¹ Grease lubrication	Oil lubrication	Cylindrical bore	NNU type Tapered bore
25	47	16	0.6	28.6	30.0	3.65	14 000	17 000	—	—
30	55	19	1	34.0	37.0	4.55	12 000	15 000	—	—
35	62	20	1	42.0	47.5	5.80	11 000	13 000	—	—
40	68	21	1	48.0	55.5	6.75	9 700	11 000	—	—
45	75	23	1	57.5	68.5	8.35	8 800	10 000	—	—
50	80	23	1	59.0	72.5	8.85	8 000	9 400	—	—
55	90	26	1.1	77.0	96.5	11.8	7 300	8 600	—	—
60	95	26	1.1	78.5	102	12.4	6 700	7 900	—	—
65	100	26	1.1	83.0	111	13.6	6 200	7 300	—	—
70	110	30	1.1	105	143	17.4	5 800	6 800	—	—
75	115	30	1.1	107	149	18.2	5 400	6 300	—	—
80	125	34	1.1	128	179	21.6	5 100	5 900	—	—
85	130	34	1.1	135	194	23.1	4 800	5 600	—	—
90	140	37	1.5	158	228	26.6	4 500	5 300	—	—
95	145	37	1.5	162	238	27.4	4 300	5 000	—	—
100	140	40	1.1	145	260	30.0	4 300	5 100	NNU4920	NNU4920K
	150	37	1.5	170	256	29.2	4 000	4 800	—	—
105	145	40	1.1	147	268	30.5	4 100	4 800	NNU4921	NNU4921K
	160	41	2	220	320	36.0	3 800	4 500	—	—
110	150	40	1.1	152	284	32.0	3 900	4 600	NNU4922	NNU4922K
	170	45	2	254	375	41.5	3 600	4 300	—	—

1) Smallest allowable dimension for chamfer dimension r.
2) "K" indicates bearings having a tapered bore with a taper ratio of 1:12.

● Double Row Cylindrical Roller Bearings

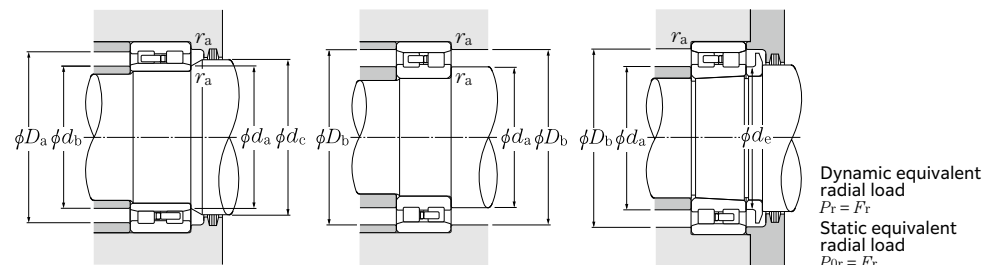

Bearing number ²⁾	Dimension		Installation-related dimensions								Mass (approx.) kg				
	Cylindrical bore	Tapered bore	F _w	E _w	d _a Min.	d _e Min.	d _b Max.	d _c Min.	D _a Max.	D _b Max.	D _b Min.	r _{as} Max.	NNU type Cylindrical bore	NN type Tapered bore	NN type Cylindrical bore
NN3005	NN3005K	—	41.3	29	30	—	—	—	43	42	0.6	—	—	0.124	0.121
NN3006	NN3006K	—	48.5	35	36.5	—	—	—	50	49	1	—	—	0.199	0.193
NN3007	NN3007K	—	55	40	41.5	—	—	—	57	56	1	—	—	0.242	0.235
NN3008	NN3008K	—	61	45	47	—	—	—	63	62	1	—	—	0.312	0.303
NN3009	NN3009K	—	67.5	50	52	—	—	—	70	69	1	—	—	0.405	0.393
NN3010	NN3010K	—	72.5	55	57	—	—	—	75	74	1	—	—	0.433	0.419
NN3011	NN3011K	—	81	61.5	63.5	—	—	—	83.5	82	1	—	—	0.651	0.631
NN3012	NN3012K	—	86.1	66.5	68.5	—	—	—	88.5	87	1	—	—	0.704	0.683
NN3013	NN3013K	—	91	71.5	73.5	—	—	—	93.5	92	1	—	—	0.758	0.735
NN3014	NN3014K	—	100	76.5	79	—	—	—	103.5	101	1	—	—	1.04	1.01
NN3015	NN3015K	—	105	81.5	84	—	—	—	108.5	106	1	—	—	1.14	1.11
NN3016	NN3016K	—	113	86.5	89.5	—	—	—	118.5	114	1	—	—	1.52	1.47
NN3017	NN3017K	—	118	91.5	94.5	—	—	—	123.5	119	1	—	—	1.61	1.56
NN3018	NN3018K	—	127	98	101	—	—	—	132	129	1.5	—	—	2.07	2.01
NN3019	NN3019K	—	132	103	106	—	—	—	137	134	1.5	—	—	2.17	2.1
NN4920	NN4920K	113	129	106.5	110	111	115	133.5	133.5	131	1	1.83	1.75	1.75	1.67
NN3020	NN3020K	—	137	108	111	—	—	—	142	139	1.5	—	—	2.26	2.19
NN4921	NN4921K	118	134	111.5	115	116	120	138.5	138.5	136	1	1.91	1.82	1.82	1.73
NN3021	NN3021K	—	146	114	117	—	—	—	151	148	2	—	—	2.89	2.8
NN4922	NN4922K	123	139	116.5	120	121	125	143.5	143.5	141	1	1.99	1.9	1.9	1.81
NN3022	NN3022K	—	155	119	123	—	—	—	161	157	2	—	—	3.69	3.56

● Double Row Cylindrical Roller Bearings

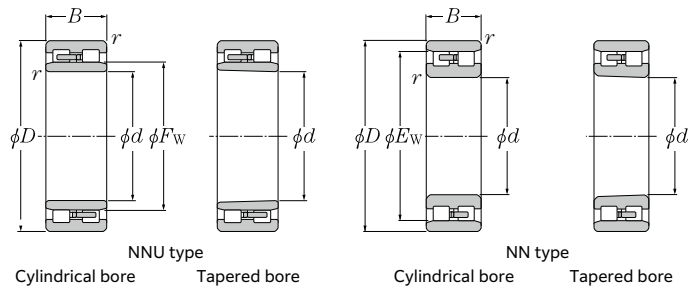

● Double Row Cylindrical Roller Bearings

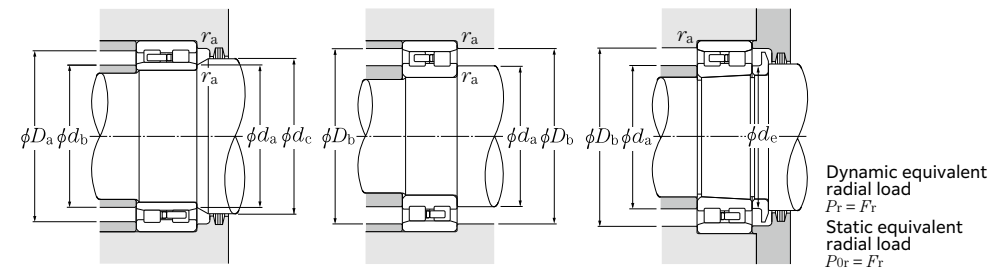

d 120 ~ 280mm

d	Boundary dimensions			Basic load rating		Fatigue load limit kN C _u	Allowable speed		Bearing number ²⁾	
	D	B	r _{s min} ¹⁾	dynamic kN C _r	static kN C _{0r}		min ⁻¹ Grease lubrication	Oil lubrication	NNU type	
	mm	mm	mm						Cylindrical bore	Tapered bore
120	165	45	1.1	203	360	39.5	3 600	4 200	NNU4924	NNU4924K
	180	46	2	258	390	42.5	3 300	3 900	—	—
130	180	50	1.5	244	440	47.0	3 300	3 900	NNU4926	NNU4926K
	200	52	2	315	475	50.0	3 100	3 600	—	—
140	190	50	1.5	251	470	49.0	3 000	3 600	NNU4928	NNU4928K
	210	53	2	330	515	53.0	2 800	3 300	—	—
150	210	60	2	380	690	70.5	2 800	3 300	NNU4930	NNU4930K
	225	56	2.1	370	585	59.0	2 600	3 100	—	—
160	220	60	2	395	740	74.0	2 600	3 100	NNU4932	NNU4932K
	240	60	2.1	415	660	65.5	2 500	2 900	—	—
170	230	60	2	400	765	75.5	2 500	2 900	NNU4934	NNU4934K
	260	67	2.1	490	775	75.0	2 300	2 700	—	—
180	250	69	2	510	965	93.0	2 300	2 700	NNU4936	NNU4936K
	280	74	2.1	630	995	94.5	2 200	2 600	—	—
190	260	69	2	525	1 030	98.0	2 200	2 600	NNU4938	NNU4938K
	290	75	2.1	640	1 040	97.0	2 000	2 400	—	—
200	280	80	2.1	615	1 180	110	2 100	2 400	NNU4940	NNU4940K
	310	82	2.1	725	1 170	107	1 900	2 300	—	—
220	300	80	2.1	650	1 300	118	1 900	2 200	NNU4944	NNU4944K
	340	90	3	905	1 480	132	1 700	2 100	—	—
240	320	80	2.1	680	1 410	126	1 700	2 000	NNU4948	NNU4948K
	360	92	3	945	1 600	140	1 600	1 900	—	—
260	360	100	2.1	1 000	2 070	179	1 600	1 800	NNU4952	NNU4952K
	400	104	4	1 180	1 990	170	1 500	1 700	—	—
280	380	100	2.1	1 030	2 200	187	1 400	1 700	NNU4956	NNU4956K
	420	106	4	1 200	2 080	174	1 300	1 600	—	—

1) Smallest allowable dimension for chamfer dimension r.
2) "K" indicates bearings having a tapered bore with a taper ratio of 1:12.
B-122

Bearing number ²⁾	Dimension		Installation-related dimensions								Mass (approx.) kg				
	mm F _w	mm E _w	mm								NNU type		NN type		
			d _a Min.	d _e Min.	d _b Max.	d _c Min.	D _a Max.	D _b Max.	D _b Min.	r _{as} Max.	Cylindrical bore	Tapered bore	Cylindrical bore	Tapered bore	
NN4924	NN4924K	134.5	154.5	126.5	130	133	137	158.5	158.5	156.5	1	2.75	2.63	2.63	2.51
NN3024	NN3024K	—	165	129	133	—	—	—	171	167	2	—	—	3.98	3.83
NN4926	NN4926K	146	168	138	142	144	148	172	172	170	1.5	3.69	3.52	3.52	3.35
NN3026	NN3026K	—	182	139	143	—	—	—	191	183	2	—	—	5.92	5.71
NN4928	NN4928K	156	178	148	152	154	158	182	182	180	1.5	3.94	3.76	3.76	3.58
NN3028	NN3028K	—	192	149	153	—	—	—	201	194	2	—	—	6.44	6.21
NN4930	NN4930K	168.5	196.5	159	164	166	171	201	201	198.5	2	6.18	5.9	5.9	5.62
NN3030	NN3030K	—	206	161	166	—	—	—	214	208	2	—	—	7.81	7.53
NN4932	NN4932K	178.5	206.5	169	174	176	182	211	211	208.5	2	6.53	6.23	6.24	5.94
NN3032	NN3032K	—	219	171	176	—	—	—	229	221	2	—	—	8.92	8.59
NN4934	NN4934K	188.5	216.5	179	184	186	192	221	221	218.5	2	6.87	6.55	6.56	6.24
NN3034	NN3034K	—	236	181	187	—	—	—	249	238	2	—	—	12.6	12.2
NN4936	NN4936K	202	234	189	195	199	205	241	241	236	2	9.9	9.46	9.45	9.01
NN3036	NN3036K	—	255	191	197	—	—	—	269	257	2	—	—	16.6	16
NN4938	NN4938K	212	244	199	205	209	215	251	251	246	2	10.4	9.94	9.93	9.47
NN3038	NN3038K	—	265	201	207	—	—	—	279	267	2	—	—	18	17.4
NN4940	NN4940K	225	261	211	218	222	228	269	269	264	2	14.7	14	14	13.3
NN3040	NN3040K	—	282	211	218	—	—	—	299	285	2	—	—	21.6	20.8
NN4944	NN4944K	245	281	231	238	242	248	289	289	284	2	15.9	15.2	15.2	14.5
NN3044	NN3044K	—	310	233	240	—	—	—	327	313	2.5	—	—	29.3	28.2
NN4948	NN4948K	265	301	251	258	262	269	309	309	304	2	17.2	16.4	16.4	15.6
NN3048	NN3048K	—	330	253	261	—	—	—	347	333	2.5	—	—	32.8	31.6
NN4952	NN4952K	292	336	271	279	288	296	349	349	339	2	29.6	28.3	28.3	27
NN3052	NN3052K	—	364	276	285	—	—	—	384	367	3	—	—	47.4	45.8
NN4956	NN4956K	312	356	291	299	308	316	369	369	359	2	31.6	30.2	30.2	28.8
NN3056	NN3056K	—	384	296	305	—	—	—	404	387	3	—	—	51.1	49.3

● Double Row Cylindrical Roller Bearings

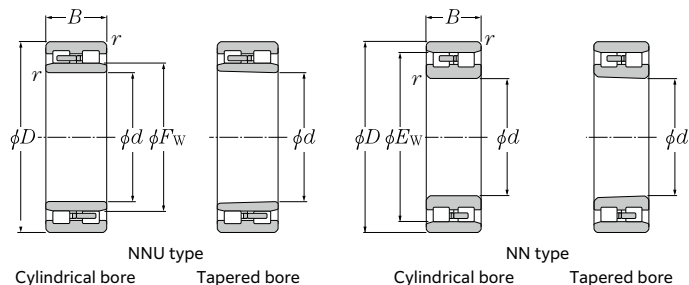

● Double Row Cylindrical Roller Bearings

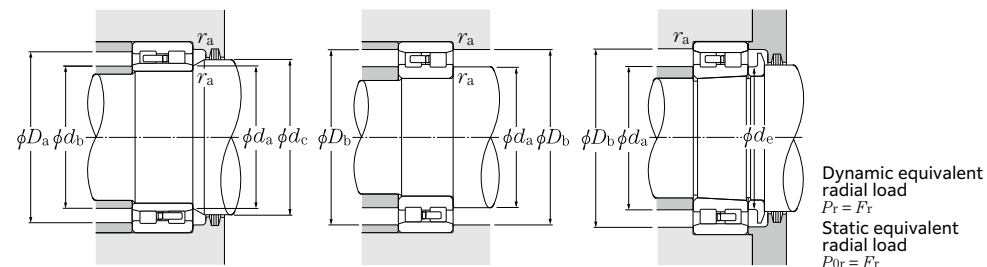

d 300 ~ 500mm

d	Boundary dimensions			Basic load rating		Fatigue load limit kN C _u	Allowable speed		Bearing number ²⁾	
	D	B	r _{s min} ¹⁾	dynamic kN C _r	static kN C _{0r}		Grease lubrication min ⁻¹	Oil lubrication	Cylindrical bore	Tapered bore
300	420	118	3	1 330	2 800	231	1 300	1 500	NNU4960	NNU4960K
	460	118	4	1 470	2 560	209	1 200	1 500	—	—
320	440	118	3	1 370	2 970	242	1 200	1 400	NNU4964	NNU4964K
	480	121	4	1 500	2 670	214	1 100	1 300	—	—
340	460	118	3	1 410	3 150	252	1 100	1 300	NNU4968	NNU4968K
	520	133	5	1 800	3 200	251	1 100	1 300	—	—
360	480	118	3	1 430	3 250	255	1 100	1 300	NNU4972	NNU4972K
	540	134	5	1 830	3 300	258	1 000	1 200	—	—
380	520	140	4	1 810	4 050	315	1 000	1 200	NNU4976	NNU4976K
	560	135	5	1 870	3 450	265	940	1 100	—	—
400	540	140	4	1 870	4 300	325	940	1 100	NNU4980	NNU4980K
	600	148	5	2 260	4 150	310	880	1 000	—	—
420	560	140	4	1 930	4 500	340	900	1 100	NNU4984	NNU4984K
	620	150	5	2 300	4 300	320	840	990	—	—
440	600	160	4	2 380	5 550	410	850	1 000	NNU4988	NNU4988K
	650	157	6	2 680	5 100	370	800	940	—	—
460	620	160	4	2 460	5 850	430	800	950	NNU4992	NNU4992K
	680	163	6	2 830	5 350	385	750	890	—	—
480	650	170	5	2 530	5 900	425	770	910	NNU4996	NNU4996K
500	670	170	5	2 670	6 400	455	730	860	NNU49/500	NNU49/500K

Bearing number ²⁾	Dimension		Installation-related dimensions										Mass (approx.) kg			
	Cylindrical bore	Tapered bore	F _w	E _w	d _a Min.	d _e Min.	d _b Max.	d _c Min.	D _a Max.	D _b Max.	D _b Min.	r _{as} Max.	NNU type Cylindrical bore	NN type Tapered bore	NN type Cylindrical bore	NN type Tapered bore
NN4960	NN4960K	339	391	313	323	335	343	407	407	394	2.5	48.6	46.4	46.4	44.2	
NN3060	NN3060K	—	418	316	326	—	—	—	444	421	3	—	—	70.8	68.6	
NN4964	NN4964K	359	411	333	343	355	363	427	427	414	2.5	51.4	49.1	49	46.7	
NN3064	NN3064K	—	438	336	346	—	—	—	464	441	3	—	—	76.2	73.5	
—	—	379	—	353	363	375	383	447	—	—	2.5	54.2	51.7	—	—	
NN3068	NN3068K	—	473	360	371	—	—	—	500	477	4	—	—	102	98.5	
—	—	398	—	373	383	394	402	467	—	—	2.5	57	54.4	—	—	
NN3072	NN3072K	—	493	380	391	—	—	—	520	497	4	—	—	107	103	
—	—	425	—	396	408	420	430	504	—	—	3	84.5	80.6	—	—	
NN3076	NN3076K	—	512	400	411	—	—	—	540	516	4	—	—	113	109	
—	—	445	—	416	428	440	450	524	—	—	3	88.2	84.1	—	—	
NN3080	NN3080K	—	547	420	432	—	—	—	580	551	4	—	—	146	141	
—	—	465	—	436	448	460	470	544	—	—	3	92	87.7	—	—	
NN3084	NN3084K	—	567	440	452	—	—	—	600	571	4	—	—	154	148	
—	—	492	—	456	469	487	497	584	—	—	3	127	121	—	—	
NN3088	NN3088K	—	596	464	477	—	—	—	626	601	5	—	—	178	172	
—	—	512	—	476	489	507	517	604	—	—	3	132	126	—	—	
NN3092	NN3092K	—	622	484	498	—	—	—	656	627	5	—	—	202	195	
—	—	534	—	500	514	531	541	630	—	—	4	156	149	—	—	
—	—	556	—	520	534	551	561	650	—	—	4	162	155	—	—	

1) Smallest allowable dimension for chamfer dimension r.
2) "K" indicates bearings having a tapered bore with a taper ratio of 1:12.

Tapered Roller Bearings



Single row tapered roller bearing

Double row tapered roller bearing

1. Types, design features, and characteristics

Tapered roller bearings are designed so the tapered vertex of the raceway surfaces of the inner and outer rings and rollers converge at one point on the centerline of the bearing (see Fig. 1).

The tapered rollers are guided by the compound force of the inner and outer raceway surfaces which keep the rollers pressed up against the large rib on the inner ring.

A large variety of these bearings, including single, double, and four row arrangements, are available in both metric and inch series. Each

type and associated characteristics are shown in Table 1. For four-row tapered roller bearings, see section "C. Special application bearings."

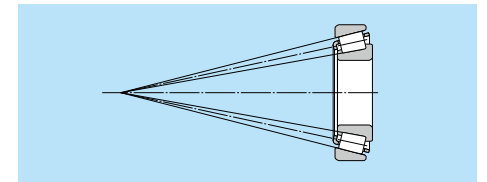

Fig. 1

Table 1 Tapered roller bearing types and characteristics

Type	Characteristics									
Single row tapered roller bearings	(1) There are both metric and inch series adhering to the standards shown in the following table. Dimension series <table border="1"> <thead> <tr> <th></th> <th>Metric series</th> <th>Inch series</th> </tr> </thead> <tbody> <tr> <td>Standard</td> <td> <ul style="list-style-type: none"> ● JIS B 1534 ● JIS B 1512 ● ISO 355 </td> <td> <ul style="list-style-type: none"> ● ABMA (includes metric J-series) </td> </tr> <tr> <td>Basic number</td> <td>Example, 30210 *T2EE040</td> <td>Inner ring no. / outer ring no. ("J" appears at the beginning of the basic number in the case of J-series.)</td> </tr> </tbody> </table> <p>* Dimension series previously not covered by 3XX are regulated under JIS B 1512; dimensions previously missing from 3XX will henceforth use the bearing number.</p>		Metric series	Inch series	Standard	<ul style="list-style-type: none"> ● JIS B 1534 ● JIS B 1512 ● ISO 355 	<ul style="list-style-type: none"> ● ABMA (includes metric J-series) 	Basic number	Example, 30210 *T2EE040	Inner ring no. / outer ring no. ("J" appears at the beginning of the basic number in the case of J-series.)
		Metric series	Inch series							
Standard	<ul style="list-style-type: none"> ● JIS B 1534 ● JIS B 1512 ● ISO 355 	<ul style="list-style-type: none"> ● ABMA (includes metric J-series) 								
Basic number	Example, 30210 *T2EE040	Inner ring no. / outer ring no. ("J" appears at the beginning of the basic number in the case of J-series.)								
	(2) In addition to the standard design, there are also medium contact angle and large contact angle types, denoted by the contact angle codes at the end of the part numbers (C and D, respectively). (3) Subunits Tapered roller bearings can be disassembled into parts: the inner ring, rollers, and cage (collectively known as the "CONE") and the outer ring (known as the "CUP"). These are the bearing's "subunits". Subunit dimensions are standardized under ISO or ABMA standards, and unified subunits are interchangeable within each dimensional standard. However, high precision grade bearings are generally not interchangeable, and these subunits must be used by assembling only subunits with identical manufacturing numbers. Aside from any cautionary notes that may appear, the single row tapered roller bearings listed in the dimension tables have subunits standardized for both metric and inch systems (including J series). (Refer to Fig. 2) <div style="text-align: center;"> </div>									

Table 1 (continued)

Type	Characteristics
Single row tapered roller bearings	<p>(4) These bearings are constructed to have a high capacity for radial loads, axial loads, and combined loads. The larger the contact angle, the greater the axial load capacity. When a pure radial load is applied to a tapered roller bearing, an induced load in the axial direction is also generated, so these bearings are generally used in pairs.</p> <p>(5) Single row tapered roller bearings are separable, so both the inner and outer rings can be used with tight fits.</p> <p>(6) Tapered roller bearings are also manufactured with flanges attached to the outer rings. For more details, contact NTN Engineering. (Refer to Fig. 3)</p>
Duplex tapered roller bearings	<p>(1) When two single-row tapered roller bearings are to be used in combination, the bearing clearance and preload are adjusted by the inner ring spacer or the outer ring spacer (see Fig. 4).</p> <p>(2) A product number and a combination code are indicated on inner rings, outer rings, and spacers. Parts displaying the same number and code must be used in combination.</p> <p>(3) See A-96 Table 8.14 for the axial internal clearance.</p>
Double row tapered roller bearings	<p>(1) Back-to-back arrangement (using double row outer rings) and face-to-face arrangement (using double row inner rings) are both available. The assemblies have been adjusted so that each type's internal clearance values are fixed. Only parts with identical manufacturing numbers can be used and they must be assembled according to their code numbers. (Refer to Fig. 5)</p> <p>(2) See A-96 Table 8.14 for the axial internal clearance of double-row and duplex bearings.</p>

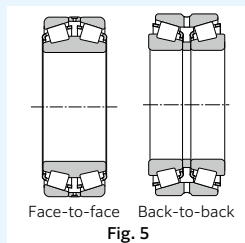
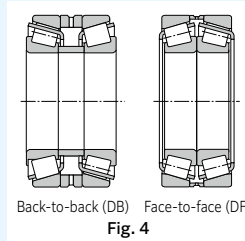
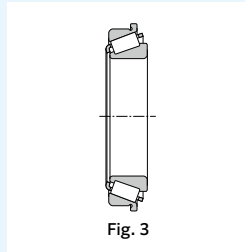

2. Standard cage type

In general, pressed cages (see **Fig. 6**) are used in tapered roller bearings. For large sized bearings, machined or pin type cages may also be used, while resin cages may also be used for smaller sized bearings.



Fig. 6 Pressed steel cage

3. Allowable misalignment

In order to avoid edge loading and potential for premature failure, the maximum allowable misalignment based on bearing series can be found below.

The allowable misalignment of combined bearings is influenced by the load center position, so please consult **NTN Engineering**.

- Single row (standard) 1/ 2 000
- Single row (ULTAGE) 1/ 600

4. Precautions

If bearing load is light during operation, or if the ratio of axial to radial load for duplex and double row bearings exceeds the value of e , slipping may develop between the rollers and raceway surface, sometimes resulting in smearing. The mass of rollers and cages particularly tends to be large for large tapered roller bearings. For additional details, please contact **NTN Engineering**.

In tapered roller bearings, the cage may protrude beyond the inner and/or outer ring side faces. Care should be taken when designing the housing and shaft to ensure contact with the cage does not occur.

5. Tapered roller bearing (ULTAGE) series

The **ULTAGE tapered roller bearings** have been developed for “long operating life,” “improved load capacity,” and “higher speed” required for various types of industrial machinery.

For details, see the **special catalog (CAT. No. 3035/E)**.

Inch Series Tapered Roller Bearings (Single Row) Index

Series number	Bearing number CONE / CUP	Page of bearing dimension table	Series number	Bearing number CONE / CUP	Page of bearing dimension table	Series number	Bearing number CONE / CUP	Page of bearing dimension table
335	336 / 332	B-167	495	498 / 493	B-185	745	749 / 742	B-185
335	339 / 332	B-163	525	527 / 522	B-167	745	749A / 742	B-183
335	344 / 332	B-165	525	528 / 522	B-169	755	756A / 752	B-183
355	350A / 354A	B-165	525	529 / 522	B-173	755	757 / 752	B-183
355	355 / 354A	B-167	535	537 / 532X	B-173	755	758 / 752	B-185
355	358 / 354A	B-169	535	539 / 532X	B-173	755	759 / 752	B-185
355	359A / 354A	B-169	535	543 / 532X	B-165	755	760 / 752	B-185
355	359S / 352	B-169	555	555 / 552A	B-173	775	780 / 772	B-187
365	365 / 362A	B-171	555	555S / 552A	B-175	775	782 / 772	B-187
365	366 / 362A	B-171	555	557S / 552A	B-173	795	799 / 792	B-189
365	367 / 362A	B-169	555	558 / 552A	B-177	795	799A / 792	B-189
365	368 / 362A	B-171	555	559 / 552A	B-177	835	835 / 832	B-179
365	368A / 362	B-171	555	560 / 552A	B-179	835	842 / 832	B-183
365	368S / 362A	B-173	555	560S / 552A	B-179	835	850 / 832	B-185
365	369A / 362A	B-169	565	565 / 563	B-177	855	861 / 854	B-187
365	370A / 362A	B-171	565	566 / 563	B-179	895	896 / 892	B-191
385	385 / 382A	B-175	565	567 / 563	B-181	895	898 / 892	B-191
385	385A / 382A	B-171	565	567A / 563	B-181	935	936 / 932	B-187
385	386A / 382A	B-169	565	568 / 563	B-181	935	938 / 932	B-189
385	387 / 382A	B-175	575	575 / 572	B-181	935	941 / 932	B-187
385	387A / 382A	B-175	575	575S / 572	B-181	1200	1280 / 1220	B-157
385	387AS / 382A	B-175	575	576 / 572	B-181	1300	1380 / 1328	B-155
385	387S / 382A	B-175	575	577 / 572	B-181	1300	1380 / 1329	B-155
385	388A / 382A	B-175	575	580 / 572	B-183	1700	1755 / 1729	B-157
385	389 / 382A	B-175	575	581 / 572	B-183	1700	1775 / 1729	B-155
385	389A / 382A	B-173	575	582 / 572	B-183	1700	1779 / 1729	B-157
395	390 / 394A	B-175	595	593 / 592A	B-185	1700	1780 / 1729	B-157
395	390A / 394A	B-177	595	594 / 592A	B-187	1900	1985 / 1930	B-157
395	392 / 394A	B-177	595	594A / 592XE	B-187	1900	1985 / 1931	B-159
395	395A / 394A	B-179	595	595 / 592A	B-183	1900	1985 / 1932	B-159
395	396 / 394A	B-171	595	596 / 592A	B-185	2400	2474 / 2420	B-159
395	397 / 394A	B-179	595	598A / 592A	B-185	2500	2558 / 2523	B-159
395	399A / 394A	B-179	615	619 / 612	B-173	2500	2578 / 2523	B-159
415	418 / 414	B-165	615	621 / 612	B-173	2500	2580 / 2520	B-161
415	420 / 414	B-165	615	623 / 612	B-175	2500	2580 / 2523	B-161
435	436 / 432	B-169	635	639 / 632	B-177	2500	2582 / 2523	B-161
435	438 / 432	B-167	635	641 / 632	B-179	2500	2585 / 2523	B-161
455	455 / 453X	B-173	635	641 / 633	B-179	2600	2682 / 2631	B-157
455	460 / 453X	B-167	635	643 / 632	B-179	2600	2687 / 2631	B-157
455	462 / 453X	B-175	635	644 / 632	B-181	2600	2688 / 2631	B-157
455	463 / 453X	B-169	655	655 / 653	B-179	2600	2689 / 2631	B-159
455	469 / 453A	B-175	655	659 / 653	B-181	2600	2695 / 2631	B-159
455	469 / 453X	B-175	655	661 / 653	B-183	2700	2776 / 2720	B-165
455	469 / 454	B-175	655	663 / 652	B-183	2700	2780 / 2720	B-163
475	477 / 472	B-177	655	663 / 653	B-183	2700	2785 / 2720	B-161
475	480 / 472	B-179	655	665 / 653	B-185	2700	2788 / 2720	B-165
475	482 / 472	B-179	675	681 / 672	B-185	2700	2789 / 2720	B-165
475	483 / 472	B-177	675	683 / 672	B-187	2700	2793 / 2720	B-161
475	484 / 472	B-181	675	685 / 672	B-187	2700	2796 / 2729	B-163
495	495 / 493	B-183	675	687 / 672	B-187	2700	2793 / 2735X	B-161
495	495A / 493	B-181	745	740 / 742	B-183	2800	2878 / 2820	B-161
495	495AS / 493	B-183	745	744 / 742	B-181	2800	2879 / 2820	B-161
495	496 / 493	B-183	745	745A / 742	B-179	2900	2984 / 2924	B-169
495	497 / 492A	B-185	745	748S / 742	B-181	3100	3187 / 3120	B-159

Inch Series Tapered Roller Bearings (Single Row) Index

Series number	Bearing number CONE / CUP	Page of bearing dimension table	Series number	Bearing number CONE / CUP	Page of bearing dimension table	Series number	Bearing number CONE / CUP	Page of bearing dimension table
3100	3188 / 3120	B-161	6500	6576 / 6535	B-183	15000	15112 / 15245	B-159
3100	3193 / 3120	B-161	6500	6580 / 6535	B-185	15000	15116 / 15245	B-159
3100	3196 / 3120	B-161	02400	02474 / 02420	B-159	15000	15117 / 15245	B-159
3300	3379 / 3320	B-163	02400	02475 / 02420	B-161	15000	15118 / 15245	B-159
3300	3382 / 3321	B-165	02400	02476 / 02420	B-161	15000	15119 / 15245	B-159
3300	3382 / 3339	B-165	02800	02872 / 02820	B-159	15000	15120 / 15245	B-159
3300	3386 / 3320	B-165	02800	02875 / 02820	B-161	15000	15123 / 15245	B-159
3400	3476 / 3420	B-161	02800	02877 / 02820	B-161	15000	15125 / 15245	B-159
3400	3478 / 3420	B-163	02800	02878 / 02820	B-161	15000	15126 / 15245	B-161
3400	3479 / 3420	B-163	03000	03062 / 03162	B-155	15500	15580 / 15523	B-157
3400	3490 / 3420	B-165	05000	05062 / 05185	B-155	15500	15590 / 15520	B-157
3500	3576 / 3525	B-167	05000	05066 / 05185	B-155	15500	15590 / 15523	B-159
3500	3578 / 3520	B-167	05000	05075 / 05185	B-155	16000	16137 / 16284	B-161
3500	3578 / 3525	B-167	05000	05079 / 05185	B-155	16000	16150 / 16282	B-163
3500	3579 / 3525	B-167	07000	07079 / 07196	B-155	17000	17118 / 17244	B-159
3500	3580 / 3525	B-165	07000	07087 / 07196	B-155	17000	17119 / 17244	B-159
3500	3586 / 3525	B-169	07000	07093 / 07196	B-157	17500	17580 / 17520	B-155
JS3500	JS3549A / JS3510	B-163	07000	07096 / 07196	B-157	18500	18590 / 18520	B-165
3700	3767 / 3720	B-173	07000	07097 / 07196	B-157	18600	18685 / 18620	B-167
3700	3775 / 3720	B-171	07000	07098 / 07196	B-157	18600	18690 / 18620	B-169
3700	3776 / 3720	B-169	07000	07100 / 07196	B-157	18700	18790 / 18720	B-171
3700	3777 / 3720	B-169	07000	07100 / 07204	B-157	18700	18790 / 18724	B-171
3700	3778 / 3720	B-169	07000	07100S / 07196	B-157	19000	19150 / 19281	B-163
3700	3780 / 3720	B-171	09000	09062 / 09195	B-155	21000	21075 / 21212	B-155
3700	3780 / 3726	B-171	09000	09067 / 09195	B-155	22700	22780 / 22720	B-167
3700	3780 / 3732	B-171	09000	09067 / 09196	B-155	23000	23100 / 23256	B-157
3700	3781 / 3720	B-171	09000	09078 / 09195	B-155	24700	24780 / 24720	B-165
3700	3782 / 3720	B-167	09000	09081 / 09195	B-155	25500	25572 / 25520	B-165
3800	3872 / 3820	B-163	11000	11162 / 11300	B-165	25500	25577 / 25520	B-167
3800	3875 / 3820	B-165	11000	11162 / 11315	B-165	25500	25578 / 25520	B-167
3800	3880 / 3820	B-167	11500	11590 / 11520	B-155	25500	25580 / 25520	B-167
3900	3975 / 3920	B-173	LM11700	LM11749 / LM11710	B-155	25500	25582 / 25520	B-167
3900	3979 / 3920	B-175	LM11900	LM11949 / LM11910	B-155	25500	25584 / 25520	B-169
3900	3980 / 3920	B-177	12000	12175 / 12303	B-167	25500	25590 / 25519	B-169
3900	3982 / 3920	B-177	12500	12580 / 12520	B-155	25500	25590 / 25520	B-169
3900	3984 / 3925	B-179	M12600	M12648 / M12610	B-155	25500	25590 / 25522	B-169
3900	3994 / 3920	B-179	M12600	M12649 / M12610	B-155	25500	25590 / 25526	B-169
A4000	A4050 / A4138	B-155	LM12700	LM12749 / LM12711	B-155	25500	25592 / 25520	B-169
A4000	A4059 / A4138	B-155	13600	13685 / 13621	B-163	25800	25877 / 25820	B-161
4300	4388 / 4335	B-167	13600	13687 / 13621	B-163	25800	25877 / 25821	B-161
4300	4395 / 4335	B-167	13800	13889 / 13830	B-163	25800	25880 / 25821	B-163
5300	5395 / 5335	B-171	14000	14116 / 14274	B-159	26800	26878 / 26822	B-165
5500	5578 / 5535	B-173	14000	14116 / 14276	B-159	26800	26880 / 26822	B-165
5500	5583 / 5535	B-177	14000	14117A / 14276	B-159	26800	26882 / 26823	B-165
5500	5584 / 5535	B-177	14000	14124 / 14276	B-161	26800	26882 / 26824	B-167
5700	5760 / 5735	B-181	14000	14125A / 14276	B-161	26800	26883 / 26822	B-163
A6000	A6075 / A6157	B-155	14000	14130 / 14276	B-161	26800	26884 / 26822	B-167
6200	6277 / 6220	B-169	14000	14137A / 14276	B-161	26800	26885 / 26822	B-165
6300	6379 / 6320	B-179	14000	14139 / 14276	B-163	27600	27687 / 27620	B-183
6300	6386 / 6320	B-179	15000	15100 / 15245	B-157	27600	27689 / 27620	B-183
6400	6460 / 6420	B-181	15000	15101 / 15243	B-157	27600	27690 / 27620	B-183
6400	6461 / 6420	B-183	15000	15102 / 15245	B-157	27600	27691 / 27620	B-183
6400	6461A / 6420	B-181	15000	15103 / 15245	B-157	27800	27880 / 27820	B-165
6500	6559C / 6535	B-183	15000	15106 / 15245	B-157	28000	28150 / 28300	B-165

Inch Series Tapered Roller Bearings (Single Row) Index

Series number	Bearing number CONE / CUP	Page of bearing dimension table	Series number	Bearing number CONE / CUP	Page of bearing dimension table	Series number	Bearing number CONE / CUP	Page of bearing dimension table
28000	28150 / 28315	B-165	44000	44143 / 44348	B-163	67300	67389 / 67322	B-189
28000	28158 / 28300	B-165	44000	44150 / 44348	B-165	67300	67390 / 67322	B-191
28500	28579 / 28521	B-171	44000	44158 / 44348	B-165	67300	67391 / 67322	B-191
28500	28580 / 28521	B-171	L44600	L44640 / L44610	B-157	67700	67790 / 67720	B-191
28500	28584 / 28521	B-173	L44600	L44643 / L44610	B-157	68000	68450 / 68712	B-189
28600	28678 / 28622	B-171	L44600	L44649 / L44610	B-157	68000	68462 / 68712	B-191
28600	28680 / 28622	B-175	45200	45280 / 45220	B-169	L68100	L68149 / L68111	B-163
28600	28682 / 28622	B-175	45200	45282 / 45220	B-171	L69300	JL69349 / JL69310	B-163
28900	28985 / 28921	B-177	45200	45284 / 45220	B-173	71000	71453 / 71750	B-189
28900	28990 / 28920	B-177	45200	45287 / 45220	B-173	72000	72188 / 72487	B-171
28900	28995 / 28920	B-177	45200	45289 / 45220	B-175	72000C	72200C / 72487	B-173
29500	29580 / 29520	B-175	L45400	L45449 / L45410	B-159	72000C	72212C / 72487	B-173
29500	29585 / 29520	B-177	46000	46162 / 46368	B-167	72000C	72218C / 72487	B-175
29500	29585 / 29521	B-177	46000	46175 / 46368	B-167	72000C	72225C / 72487	B-175
29500	29586 / 29520	B-179	46700	46780 / 46720	B-191	LM72800	LM72849 / LM72810	B-157
29500	29590 / 29520	B-179	46700	46790 / 46720	B-191	74000	74500 / 74850	B-189
29600	29675 / 29620	B-179	47400	47487 / 47420	B-179	74000	74525 / 74850	B-191
29600	29675 / 29630	B-181	47400	47490 / 47420	B-181	74000	74550 / 74850	B-191
29600	29685 / 29620	B-181	47600	47678 / 47620	B-181	78000	78225 / 78551	B-175
29600	29688 / 29620	B-163	47600	47681 / 47620	B-183	78000	78250 / 78551	B-177
LM29700	LM29748 / LM29710	B-163	47600	47686 / 47620	B-183	78000C	78214C / 78551	B-173
31500	31593 / 31520	B-163	47800	47890 / 47820	B-185	LM78300	LM78349 / LM78310C	B-163
31500	31594 / 31520	B-163	47800	47896 / 47820	B-187	LM78300	LM78349A / LM78310A	B-163
31500	31597 / 31520	B-163	48200	48286 / 48220	B-189	M84500	M84548 / M84510	B-157
33000	33225 / 33462	B-175	48200	48290 / 48220	B-189	M86600	M86643 / M86610	B-157
33000	33275 / 33462	B-179	48300	48385 / 48320	B-191	M86600	M86647 / M86610	B-159
33000	33281 / 33462	B-181	48300	48393 / 48320	B-191	M86600	M86649 / M86610	B-159
33000	33287 / 33462	B-181	LM48500	LM48548 / LM48510	B-161	M88000	M88048 / M88010	B-161
33800	33885 / 33821	B-167	LM48500	LM48548A / LM48510	B-161	HM88500	JHM88540 / JHM88513	B-159
33800	33889 / 33821	B-171	48600	48684 / 48620	B-191	HM88500	HM88542 / HM88510	B-161
33800	33890 / 33821	B-173	48600	48685 / 48620	B-191	HM88500	HM88542 / HM88512	B-161
33800	33895 / 33822	B-173	49500	49585 / 49520	B-173	HM88500	HM88547 / HM88510	B-161
34000	34274 / 34478	B-179	52000	52375 / 52618	B-187	HM88600	HM88648 / HM88610	B-163
34000	34300 / 34478	B-181	52000	52387 / 52618	B-187	HM88600	HM88648 / HM88611AS	B-163
34000	34301 / 34478	B-181	52000	52393 / 52618	B-187	HM88600	HM88649 / HM88610	B-161
34000	34306 / 34478	B-183	52000	52400 / 52618	B-187	HM89200	HM89249 / HM89210	B-163
36600	36690 / 36620	B-191	53000	53162 / 53375	B-167	HM89400	HM89440 / HM89410	B-161
36900	36990 / 36920	B-191	53000	53177 / 53375	B-167	HM89400	HM89443 / HM89410	B-161
37000	37425 / 37625	B-187	55000C	55175C / 55437	B-169	HM89400	HM89444 / HM89410	B-161
37000	37431 / 37625	B-187	55000C	55176C / 55437	B-169	HM89400	HM89446 / HM89410	B-163
39500	39575 / 39520	B-173	55000C	55187C / 55437	B-171	HM89400	HM89448 / HM89410	B-163
39500	39580 / 39520	B-175	55000C	55200C / 55443	B-173	HM89400	HM89449 / HM89411	B-163
39500	39581 / 39520	B-175	56000	56425 / 56650	B-187	90000	J90354 / J90748	B-185
39500	39585 / 39520	B-177	59000	59200 / 59412	B-173	90000	90381 / 90744	B-187
39500	39590 / 39520	B-179	64000	64433 / 64700	B-189	95000	95475 / 95925	B-189
41000	41125 / 41286	B-159	64000	64450 / 64700	B-189	95000	95500 / 95905	B-189
42000	42346 / 42584	B-185	65000	65237 / 65500	B-177	95000	95525 / 95925	B-191
42000	42350 / 42584	B-185	65300	65390 / 65320	B-171	97000	97500 / 97900	B-189
42000	42368 / 42584	B-185	66000	66200 / 66462	B-173	99000	99550 / 99100	B-191
42000	42375 / 42584	B-187	66000	66225 / 66462	B-175	99000	99575 / 99100	B-191
42000	42381 / 42584	B-187	66500	66584 / 66520	B-173	LM102900	LM102949 / LM102910	B-169
42600	42687 / 42620	B-181	66500	66589 / 66520	B-175	LM104900	LM104948 / JLM104910	B-171
42600	42690 / 42620	B-183	LM67000	LM67048 / LM67010	B-159	LM104900	LM104947A / LM104911	B-171
43000	43131 / 43312	B-161	67300	67388 / 67322	B-189	LM104900	LM104949 / LM104911	B-171

Inch Series Tapered Roller Bearings (Single Row) Index

Series number	Bearing number CONE / CUP	Page of bearing dimension table	Series number	Bearing number CONE / CUP	Page of bearing dimension table	Series number	Bearing number CONE / CUP	Page of bearing dimension table
M205100	JM205149 / JM205110	B-171	M714200	JM714249 / JM714210	B-181			
M207000	JM207049 / JM207010	B-175	H715300	H715334 / H715311	B-177			
H211700	JH211749 / JH211710	B-179	H715300	H715343 / H715311	B-179			
HM212000	HM212044 / HM212011	B-177	H715300	H715345 / H715311	B-181			
HM212000	HM212046 / HM212011	B-177	H715300	H715348 / H715311	B-183			
HM212000	HM212049 / HM212110	B-179	M716600	JM716648 / JM716610	B-185			
L217800	L217849 / L217810	B-185	M718100	JM718149 / JM718110	B-185			
LL217800	LL217849 / LL217810	B-185	M719100	JM719149 / JM719113	B-185			
HM218200	HM218248 / HM218210	B-185	M720200	JM720249 / JM720210	B-187			
HH221400	HH221430 / HH221410	B-183	L724300	JL724348 / JL724314	B-189			
HH221400	HH221431 / HH221410	B-183	M736100	JM736149 / JM736110	B-191			
HH221400	HH221440 / HH221410	B-187	M738200	JM738249 / JM738210	B-191			
HH221400	HH221449 / HH221410	B-187	HM801300	HM801346 / HM801310	B-165			
HH221400	HH221449A / HH221410	B-187	HM801300	HM801349 / HM801310	B-165			
HH224300	HH224334 / HH224310	B-187	M802000	M802048 / M802011	B-167			
HH224300	HH224335 / HH224310	B-187	HM803100	HM803145 / HM803110	B-167			
HH224300	HH224346 / HH224310	B-189	HM803100	HM803149 / HM803110	B-167			
HH228300	HH228349 / HH228310	B-189	M804000	M804048 / M804010	B-169			
M231600	M231648 / M231610	B-191	HM804800	HM804840 / HM804810	B-167			
LM300800	LM300849 / LM300811	B-165	HM804800	HM804842 / HM804810	B-167			
H307700	JH307749 / JH307710	B-175	HM804800	M804846 / M804810	B-169			
HM318400	JHM318448 / JHM318410	B-185	HM804800	M804848 / M804810	B-171			
L319200	L319249 / L319210	B-187	HM804800	M804849 / M804810	B-171			
L327200	L327249 / L327210	B-189	LM806600	LM806649 / LM806610	B-173			
H414200	H414242 / H414210	B-179	HM807000	HM807040 / HM807010	B-169			
H414200	H414245 / H414210	B-179	HM807000	HM807044 / HM807010	B-171			
H414200	H414249 / H414210	B-181	HM807000	HM807046 / HM807010	B-173			
H415600	JH415647 / JH415610	B-181	HM807000	HM807048 / HM807010	B-173			
L432300	L432349 / L432310	B-191	HM807000	HM807049 / HM807010	B-173			
LM501300	LM501349 / LM501310	B-165	HM807000	JHM807045 / JHM807012	B-171			
LM501300	LM501349A / LM501314	B-165	L812100	L812148 / L812111	B-179			
LM503300	LM503349 / LM503310	B-169	LM813000	JLM813049 / JLM813010	B-179			
HH506300	HH506348 / HH506310	B-171	HM813800	HM813840 / HM813810	B-175			
HH506300	HH506349 / HH506310	B-171	HM813800	HM813841 / HM813810	B-177			
LM506800	JLM506849 / JLM506810	B-173	HM813800	HM813842 / HM813810	B-177			
LM508700	JLM508748 / JLM508710	B-175	HM813800	HM813844 / HM813810	B-179			
M511900	JM511946 / JM511910	B-177	L814700	L814749 / L814710	B-181			
M515600	JM515649 / JM515610	B-183	LM814800	LM814849 / LM814810	B-183			
HM516400	HM516442 / HM516410	B-181	M822000	JM822049 / JM822010	B-189			
HM516400	HM516448 / HM516410	B-183	HM903200	HM903245 / HM903210	B-167			
HM516800	JHM516849 / JHM516810	B-185	HM903200	HM903249 / HM903210	B-167			
LM522500	LM522546 / LM522510	B-187	M903300	M903345 / M903310	B-167			
LM522500	LM522548 / LM522510	B-189	HM907600	HM907643 / HM907614	B-173			
HM522600	JHM522649 / JHM522610	B-189	HM911200	HM911242 / HM911210	B-173			
HM534100	JHM534149 / JHM534110	B-191	HM911200	HM911245 / HM911210	B-177			
LM603000	LM603049 / LM603011	B-169	HM911200	HM911244 / JHM911211	B-177			
L610500	L610549 / L610510	B-177	H913800	H913840 / H913810	B-175			
M612900	JM612949 / JM612910	B-179	H913800	H913842 / H913810	B-177			
HM617000	HM617049 / HM617010	B-185	H913800	JH913848 / JH913811	B-181			
L630300	L630349 / L630310	B-191	H917800	H917840 / H917810	B-183			
LL639200	LL639249 / LL639210	B-191	H924000	H924045 / H924010	B-189			
LM704600	JLM704649 / JLM704610	B-171	HM926700	HM926740 / HM926710	B-189			
LM710900	JLM710949 / JLM710910	B-177	HM926700	HM926747 / HM926710	B-189			
LM714100	JLM714149 / JLM714110	B-181						

Metric series

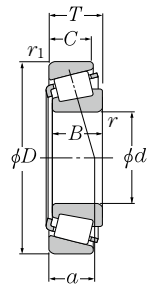

a 15 ~ 30mm

d	Boundary dimensions						Basic load rating		Fatigue load limit kN C _u	Allowable speed min ⁻¹		Bearing number 2)
	D	T	B	C	r _s min ¹⁾	r _{1s} min ¹⁾	dynamic kN C _r	static C _{0r}		Grease lubrication	Oil lubrication	
15	42	14.25	13	11	1	1	25.8	20.8	—	9 900	13 000	4T-30302
	40	13.25	12	11	1	1	22.7	20.3	—	9 900	13 000	4T-30203
17	40	17.25	16	14	1	1	30.5	28.3	—	9 900	13 000	4T-32203
	40	17.25	16	14	1	1	29.1	28.2	—	9 900	13 000	4T-32203R
	47	15.25	14	12	1	1	32.0	26.3	—	9 000	12 000	4T-30303
20	42	15	15	12	0.6	0.6	27.6	27.9	—	9 500	13 000	4T-32004X
	47	15.25	14	12	1	1	31.0	28.7	—	8 800	12 000	4T-30204
	47	19.25	18	15	1	1	40.5	39.5	—	8 800	12 000	4T-32204
	52	16.25	16	13	1.5	1.5	39.0	34.0	—	8 000	11 000	4T-30304A
	52	16.25	16	12	1.5	1.5	34.5	31.0	—	7 600	10 000	4T-30304CA
52	22.25	21	18	1.5	1.5	51.5	48.5	—	8 000	11 000	4T-32304	
22	44	15	15	11.5	0.6	0.6	30.0	31.5	—	8 900	12 000	4T-320/22X
25	47	15	15	11.5	0.6	0.6	31.0	33.5	—	7 900	11 000	4T-32005X
	47	17	17	14	0.6	0.6	36.0	40.5	—	8 000	11 000	4T-33005
	52	16.25	15	13	1	1	35.0	34.0	—	7 300	9 800	4T-30205
	52	19.25	18	16	1	1	46.5	47.0	—	7 300	9 800	4T-32205
	52	19.25	18	15	1	1	42.0	43.0	—	7 300	9 800	4T-32205R
	52	19.25	18	15	1	1	42.5	46.5	—	7 100	9 400	4T-32205C
	52	19.25	18	15	1	1	38.0	42.0	—	7 100	9 400	4T-32205CR
	52	22	22	18	1	1	52.5	57.5	—	7 300	9 800	4T-33205
	62	18.25	17	15	1.5	1.5	54.0	47.5	—	6 700	8 900	4T-30305
	62	18.25	17	14	1.5	1.5	46.0	41.5	—	6 400	8 500	4T-30305C
62	18.25	17	13	1.5	1.5	45.0	43.5	—	5 900	7 800	4T-30305D	
62	25.25	24	20	1.5	1.5	68.0	64.5	—	6 700	8 900	4T-32305	
28	52	16	16	12	1	1	37.0	40.5	—	7 300	9 700	4T-320/28X
	58	24	24	19	1	1	64.5	69.5	—	6 700	8 900	4T-332/28
30	55	17	17	13	1	1	41.5	46.0	—	6 900	9 200	4T-32006X
	55	20	20	16	1	1	47.0	54.0	—	6 900	9 200	4T-33006
	62	17.25	16	14	1	1	48.5	48.0	—	6 300	8 400	4T-30206
	62	21.25	20	17	1	1	60.5	64.0	—	6 300	8 400	4T-32206
	62	21.25	20	17	1	1	55.5	60.0	—	6 100	8 100	4T-32206C
	62	25	25	19.5	1	1	72.0	77.0	—	6 300	8 400	4T-33206
72	20.75	19	16	1.5	1.5	66.5	61.0	—	5 700	7 600	4T-30306	

1) Smallest allowable dimension for chamfer dimension r or r₁.
2) Bearings with a ○ mark do not incorporate the subunit dimensions.

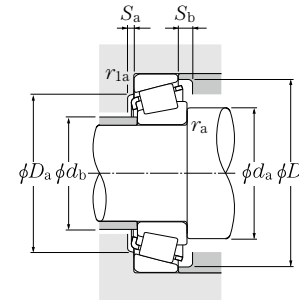

Dynamic equivalent radial load

$$P_r = X F_r + Y F_a$$

$\frac{F_a}{F_r} \leq e$		$\frac{F_a}{F_r} > e$	
X	Y	X	Y
1	0	0.4	Y ₂

Static equivalent radial load

$$P_{0r} = 0.5 F_r + Y_0 F_a$$

When $P_{0r} < F_r$ use $P_{0r} = F_r$.

For values of e, Y₂ and Y₀ see the table below.

ISO Dimension series	Installation-related dimensions										Load center mm a	Constant e	Axial load factors		Mass kg (approx.)
	d _a Min.	d _b Max.	D _a Max.	mm D _b Min.	S _a Min.	S _b Min.	r _{as} Max.	r _{1as} Max.	Y ₂	Y ₀					
2FB	20.5	22	36.5	34.5	38	2	3	1	1	9.5	0.29	2.11	1.16	0.096	
2DB	22.5	23	34.5	32.5	37.5	2	2	1	1	9.5	0.35	1.74	0.96	0.08	
2DD	22.5	22.5	34.5	32	37.5	2	3	1	1	11.5	0.31	1.92	1.06	0.102	
	22.5	22	34.5	31	37.5	2	3	1	1	11	0.35	1.74	0.96	0.105	
2FB	22.5	24.5	41.5	38.5	42.5	3	3.5	1	1	10.5	0.29	2.11	1.16	0.132	
3CC	24.5	25	37.5	33.5	39.5	3	3	0.6	0.6	10.5	0.37	1.6	0.88	0.097	
2DB	25.5	27	41.5	38.5	44	2	3	1	1	11.5	0.35	1.74	0.96	0.124	
2DD	25.5	26	41.5	37	43	2	4	1	1	12.5	0.33	1.81	1.00	0.161	
2FB	28.5	28	43.5	42.5	47.5	3	3	1.5	1.5	10.5	0.30	2.00	1.10	0.172	
	28.5	27.5	43.5	39.5	48	3	4	1.5	1.5	13.5	0.55	1.10	0.60	0.17	
2FD	28.5	27	43.5	41	47.5	3	4	1.5	1.5	14	0.30	2.00	1.10	0.242	
3CC	26.5	27	39.5	35.5	41.5	3	3.5	0.6	0.6	11	0.40	1.51	0.83	0.105	
4CC	29.5	29.5	42.5	38.5	44.5	3	3.5	0.6	0.6	12	0.43	1.39	0.77	0.113	
2CE	29.5	30	42.5	39	44.5	3	3	0.6	0.6	11	0.29	2.07	1.14	0.13	
3CC	30.5	31	46.5	42	48.5	2	3	1	1	12.5	0.37	1.60	0.88	0.155	
2CD	30.5	31	46.5	42.5	49.5	2	4	1	1	14	0.36	1.67	0.92	0.187	
	30.5	30.5	46.5	41.5	49	2	4	1	1	13.5	0.37	1.60	0.88	0.185	
5CD	30.5	30	46.5	38.5	50	2	4	1	1	16	0.58	1.03	0.57	0.192	
	30.5	30.5	46.5	39.5	49.5	2	4	1	1	16	0.55	1.10	0.60	0.189	
2DE	30.5	30.5	46.5	41	49.5	4	4	1	1	14	0.35	1.71	0.94	0.219	
2FB	33.5	34	53.5	52	57.5	3	3	1.5	1.5	13	0.30	2.00	1.10	0.268	
	33.5	34	53.5	48	58	3	4	1.5	1.5	16	0.55	1.10	0.60	0.264	
7FB	33.5	33.5	53.5	45	59	3	5	1.5	1.5	20	0.83	0.73	0.40	0.266	
2FD	33.5	33	53.5	50	57.5	3	5	1.5	1.5	16	0.30	2.00	1.10	0.377	
4CC	33.5	33	46.5	43	49.5	3	4	1	1	12.5	0.43	1.39	0.77	0.146	
2DE	33.5	33.5	52.5	47	55	5	5	1	1	15.5	0.34	1.77	0.97	0.293	
4CC	35.5	35.5	49.5	45.5	52.5	3	4	1	1	13.5	0.43	1.39	0.77	0.172	
2CE	35.5	35.5	49.5	46.5	52	3	4	1	1	13	0.29	2.06	1.13	0.201	
3DB	35.5	37.5	56.5	51	58	2	3	1	1	13.5	0.37	1.60	0.88	0.236	
3DC	35.5	36.5	56.5	50	58	2.5	4	1	1	15.5	0.37	1.60	0.88	0.299	
5DC	35.5	36	56.5	48	59.5	2	5	1	1	18.5	0.56	1.07	0.59	0.297	
2DE	35.5	36	56.5	50.5	59	5	5.5	1	1	16	0.34	1.76	0.97	0.348	
2FB	38.5	40	63.5	60	65.5	3	4.5	1.5	1.5	15	0.31	1.90	1.05	0.404	

Tapered Roller Bearings



Metric series

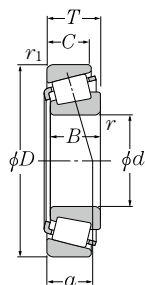

d 30 ~ 45mm

d	Boundary dimensions					Basic load rating		Fatigue load limit kN C _u	Allowable speed min ⁻¹		Bearing number ²⁾	
	mm					dynamic	static		Grease	Oil		
	D	T	B	C	r _{s min¹⁾} r _{ls min¹⁾}	C _R	C _{0r}		lubrication	lubrication		
30	72	20.75	19	15	1.5	1.5	65.0	58.5	—	5 500	7 300	4T-30306CA
	72	20.75	19	14	1.5	1.5	53.5	51.5	—	5 000	6 700	4T-30306D
	72	28.75	27	23	1.5	1.5	89.5	90.0	—	5 700	7 600	4T-32306
	72	28.75	27	23	1.5	1.5	88.0	94.0	—	5 500	7 300	4T-32306C
	72	28.75	27	23	1.5	1.5	77.5	88.5	—	5 500	7 300	○ 4T-32306CR
32	58	17	17	13	1	1	41.0	46.5	—	6 600	8 700	4T-320/32X
	65	26	26	20.5	1	1	78.5	85.0	—	6 000	8 000	4T-332/32
	75	29.75	28	23	1.5	1.5	93.5	102	—	5 200	6 900	4T-323/32C
35	55	14	14	11.5	0.6	0.6	30.5	37.5	4.60	6 800	9 000	32907XU
	62	18	18	14	1	1	46.0	52.5	—	6 100	8 100	4T-32007X
	62	21	21	17	1	1	56.0	66.5	—	6 100	8 100	4T-33007
	72	18.25	17	15	1.5	1.5	61.5	61.5	—	5 500	7 400	4T-30207
	72	24.25	23	19	1.5	1.5	80.5	87.0	—	5 500	7 400	4T-32207
	72	24.25	23	19	1.5	1.5	75.5	85.5	—	5 300	7 100	4T-32207C
	72	24.25	23	18	1.5	1.5	68.5	78.5	—	5 300	7 100	○ 4T-32207CR
	72	28	28	22	1.5	1.5	97.0	109	—	5 500	7 400	4T-33207
	80	22.75	21	18	2	1.5	83.0	77.0	—	5 000	6 600	4T-30307
	80	22.75	21	17	2	1.5	73.5	68.5	—	4 800	6 400	4T-30307C
40	80	22.75	21	15	2	1.5	70.5	70.0	—	4 400	5 800	4T-30307D
	80	32.75	31	25	2	1.5	112	115	—	5 000	6 600	4T-32307
	80	32.75	31	25	2	1.5	103	117	—	4 800	6 400	4T-32307C
	62	15	15	12	0.6	0.6	36.0	48.0	5.85	5 900	7 800	32908XU
	68	19	19	14.5	1	1	55.5	65.5	—	5 300	7 100	4T-32008X
	68	22	22	18	1	1	66.0	82.5	—	5 300	7 100	4T-33008
	75	26	26	20.5	1.5	1.5	88.0	103	—	5 200	6 900	4T-33108
	80	19.75	18	16	1.5	1.5	68.0	67.0	—	4 900	6 600	4T-30208
	80	24.75	23	19	1.5	1.5	88.0	93.5	—	4 900	6 600	4T-32208
	80	32	32	25	1.5	1.5	115	132	—	4 900	6 600	4T-33208
45	85	33	32.5	28	2.5	2	131	144	—	4 600	6 200	4T-T2EE040
	90	25.25	23	20	2	1.5	101	102	—	4 400	5 900	4T-30308
	90	25.25	23	19	2	1.5	92.0	87.0	—	4 200	5 600	4T-30308C
	90	25.25	23	17	2	1.5	85.5	85.5	—	3 900	5 200	4T-30308D
	90	35.25	33	27	2	1.5	136	150	18.3	4 400	5 900	32308U
	90	35.25	33	27	2	1.5	122	140	—	4 200	5 600	4T-32308C
	68	15	15	12	0.6	0.6	37.5	51.5	6.3	5 300	7 000	32909XU

1) Smallest allowable dimension for chamfer dimension r or r₁.
2) Bearings with a ○ mark do not incorporate the subunit dimensions.

Tapered Roller Bearings

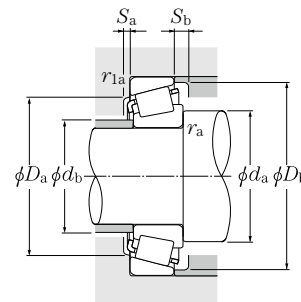

Dynamic equivalent radial load
 $P_r = X F_r + Y F_a$

$\frac{F_a}{F_r} \leq e$		$\frac{F_a}{F_r} > e$	
X	Y	X	Y
1	0	0.4	Y ₂

Static equivalent radial load

$P_{0r} = 0.5 F_r + Y_0 F_a$

When $P_{0r} < F_r$ use $P_{0r} = F_r$.

For values of e, Y₂ and Y₀ see the table below.

ISO Dimension series	Installation-related dimensions										Load center mm a	Constant e	Axial load factors		Mass kg (approx.)
	d _a	d _b	D _a		mm D _b		S _a	S _b	r _{as}	r _{1as}			Y ₂	Y ₀	
	Min.	Max.	Max.	Min.	Min.	Min.	Min.	Min.	Max.	Max.					
7FB	38.5	39.5	63.5	58	67	3	5.5	1.5	1.5	17.5	0.47	1.27	0.70	0.399	
	38.5	39.5	63.5	53.5	68	3	6.5	1.5	1.5	23.5	0.83	0.73	0.40	0.394	
	2FD	38.5	39	63.5	57.5	66.5	3	5.5	1.5	1.5	18.5	0.31	1.90	1.05	0.577
	5FD	38.5	38	63.5	52	69	2	5.5	1.5	1.5	23	0.55	1.10	0.60	0.591
	38.5	38	63.5	49.5	67.5	2	5.5	1.5	1.5	23	0.61	0.99	0.54	0.594	
4CC	37.5	37.5	52.5	47.5	55.5	3	4	1	1	14.5	0.45	1.32	0.73	0.188	
2DE	37.5	38	59.5	53	62	5	5.5	1	1	17	0.35	1.73	0.95	0.394	
5FD	40.5	40	66.5	55	71.5	3	6.5	1.5	1.5	23	0.55	1.10	0.60	0.652	
2BD	39.5	40	50.5	48	52.5	2.5	2.5	0.6	0.6	10.5	0.29	2.06	1.13	0.121	
4CC	40.5	40.5	56.5	51.5	59.5	4	4	1	1	15.5	0.45	1.32	0.73	0.223	
2CE	40.5	40.5	56.5	52	59	3	4	1	1	14	0.31	1.97	1.08	0.263	
3DB	43.5	43.5	63.5	60.5	67.5	3	3	1.5	1.5	15	0.37	1.60	0.88	0.341	
3DC	43.5	42.5	63.5	58.5	67.5	3	5	1.5	1.5	17.5	0.37	1.60	0.88	0.455	
5DC	43.5	41.5	63.5	54.5	68.5	3	6	1.5	1.5	21.5	0.58	1.03	0.57	0.461	
	43.5	42.5	63.5	55.5	68	3	6	1.5	1.5	20.5	0.55	1.10	0.60	0.462	
2DE	43.5	42	63.5	58	68.5	5	6	1.5	1.5	18.5	0.35	1.70	0.93	0.539	
2FB	45	45.5	71.5	67.5	75	3	4.5	2	1.5	17	0.31	1.90	1.05	0.535	
	45	44	71.5	63.5	75.5	3	5.5	2	1.5	20.5	0.55	1.10	0.60	0.517	
7FB	45	44.5	71.5	60.5	77	3	7.5	2	1.5	26	0.83	0.73	0.40	0.527	
2FE	45	43.5	71.5	65	75	3	7.5	2	1.5	20.5	0.31	1.90	1.05	0.782	
5FE	45	43.5	71.5	59	76	3	7.5	2	1.5	25	0.55	1.10	0.60	0.804	
2BC	44.5	45.5	57.5	54	58.5	3	3	0.6	0.6	11.5	0.29	2.07	1.14	0.161	
3CD	45.5	45.5	62.5	58	65	4	4.5	1	1	15	0.38	1.58	0.87	0.272	
2BE	45.5	46	62.5	58.5	65	2.5	4	1	1	15	0.28	2.12	1.17	0.32	
2CE	48.5	47	66.5	62.5	71.5	4	5.5	1.5	1.5	18	0.36	1.69	0.93	0.498	
3DB	48.5	48.5	71.5	67.5	74.5	3	3.5	1.5	1.5	16.5	0.37	1.60	0.88	0.431	
3DC	48.5	48.5	71.5	66.5	75	3	5.5	1.5	1.5	19	0.37	1.60	0.88	0.547	
2DE	48.5	47	71.5	64.5	76.5	5	7	1.5	1.5	21	0.36	1.68	0.92	0.738	
2EE	52	47.5	75	68	81	5	5	2	2	22.5	0.34	1.74	0.96	0.905	
2FB	50	52.5	81.5	74.5	83.5	3	5	2	1.5	19.5	0.35	1.74	0.96	0.765	
	50	50	81.5	72	85.5	3.5	6	2	1.5	23	0.55	1.10	0.60	0.726	
7FB	50	51	81.5	68.5	86	3	8	2	1.5	29.5	0.83	0.73	0.40	0.727	
2FD	50	49.5	81.5	71	83.5	3	8	2	1.5	23	0.35	1.74	0.96	1.08	
5FD	50	49	81.5	65.5	84.5	3	8	2	1.5	27.5	0.55	1.10	0.60	1.1	
2BC	49.5	51	63.5	59.5	64.5	3	3	0.6	0.6	12	0.32	1.88	1.04	0.187	

Metric series

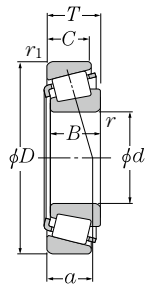

a 45 ~ 55mm

	Boundary dimensions						Basic load rating		Fatigue load limit kN C _u	Allowable speed min ⁻¹		Bearing number 2)
	mm						dynamic kN C _R	static C _{0r}		Grease lubrication	Oil lubrication	
d	D	T	B	C	r _{s min} ¹⁾	r _{1s min} ¹⁾	C _R	C _{0r}	C _u			
45	75	20	20	15.5	1	1	64.0	76.5	—	4 800	6 400	4T-32009X
	75	24	24	19	1	1	73.5	93.5	—	4 800	6 400	4T-33009
	80	26	26	20.5	1.5	1.5	94.0	115	—	4 700	6 200	4T-33109
	85	20.75	19	16	1.5	1.5	75.0	78.5	—	4 400	5 900	4T-30209
	85	24.75	23	19	1.5	1.5	91.0	100	—	4 400	5 900	4T-32209
	85	32	32	25	1.5	1.5	119	141	—	4 400	5 900	4T-33209
	95	29	26.5	20	2.5	2.5	99.5	108	—	4 100	5 500	4T-T7FC045
	100	27.25	25	22	2	1.5	123	126	—	4 000	5 300	4T-30309D
	100	27.25	25	18	2	1.5	106	109	—	3 500	4 600	4T-30309D
	100	38.25	36	30	2	1.5	170	191	23.3	4 000	5 300	32309U
100	38.25	36	30	2.5	0.6	145	175	21.4	3 800	5 100	32309CU	
50	72	15	15	12	0.6	0.6	39.5	57.0	6.95	4 700	6 300	32910XU
	72	15	14	12	0.6	0.6	35.0	50.5	6.15	4 700	6 300	○ 32910
	80	20	20	15.5	1	1	69.5	88.0	—	4 400	5 800	4T-32010X
	80	24	24	19	1	1	77.5	103	—	4 400	5 800	4T-33010
	85	26	26	20	1.5	1.5	96.0	121	—	4 200	5 600	4T-33110
	90	21.75	20	17	1.5	1.5	85.5	93.0	—	4 000	5 300	4T-30210
	90	24.75	23	19	1.5	1.5	97.0	109	—	4 000	5 300	4T-32210
	90	32	32	24.5	1.5	1.5	127	158	—	4 000	5 300	4T-33210
	100	36	35	30	2.5	2.5	167	190	—	3 800	5 100	4T-T2ED050
	105	32	29	22	3	3	119	132	—	3 400	4 500	4T-T7FC050
110	29.25	27	23	2.5	2	147	152	—	3 600	4 800	4T-30310	
110	29.25	27	19	2.5	2	126	130	—	3 200	4 200	4T-30310D	
110	42.25	40	33	2.5	2	204	232	28.3	3 600	4 800	32310U	
110	42.25	40	33	2.5	2.5	178	220	—	3 500	4 600	4T-32310C	
55	80	17	17	14	1	1	49.5	73.5	8.95	4 300	5 700	32911XU
	90	23	23	17.5	1.5	1.5	89.0	118	—	4 000	5 400	4T-32011X
	90	27	27	21	1.5	1.5	102	138	—	4 000	5 400	4T-33011
	95	30	30	23	1.5	1.5	123	155	—	3 900	5 200	4T-33111
	100	22.75	21	18	2	1.5	103	111	—	3 600	4 900	4T-30211
	100	26.75	25	21	2	1.5	120	134	—	3 600	4 900	4T-32211
	100	35	35	27	2	1.5	153	188	—	3 600	4 900	4T-33211
	115	34	31	23.5	3	3	137	156	—	3 300	4 400	4T-T7FC055
	120	31.5	29	25	2.5	2	172	179	—	3 300	4 400	4T-30311
	120	31.5	29	21	2.5	2	146	154	—	2 900	3 800	4T-30311D
120	45.5	43	35	2.5	2	238	275	33.5	3 300	4 400	32311U	
120	45.5	43	35	2.5	2.5	204	252	30.5	3 100	4 200	32311CU	

1) Smallest allowable dimension for chamfer dimension r or r₁.
2) Bearings with a ○ mark do not incorporate the subunit dimensions.

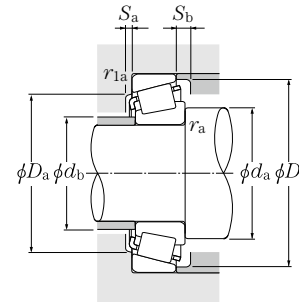

Dynamic equivalent radial load

$P_r = XF_r + YF_a$

$\frac{F_a}{F_r} \leq e$	$\frac{F_a}{F_r} > e$
X	Y
1	Y ₂

Static equivalent radial load

$P_{0r} = 0.5F_r + Y_0F_a$

When $P_{0r} < F_r$ use $P_{0r} = F_r$.

For values of e, Y₂ and Y₀ see the table below.

ISO Dimension series	Installation-related dimensions										Load center mm a	Constant e	Axial load factors		Mass kg (approx.)
	d _a Min.	d _b Max.	D _a Max.	mm D _b Min.	S _a Min.	S _b Min.	r _{as} Max.	r _{1as} Max.	Y ₂	Y ₀					
3CC	50.5	51	69.5	64	72.5	4	4.5	1	1	16.5	0.39	1.53	0.84	0.341	
2CE	50.5	51.5	69.5	64	71.5	4	5	1	1	16	0.29	2.04	1.12	0.405	
3CE	53.5	51.5	71.5	67.5	76.5	4	5.5	1.5	1.5	19.5	0.38	1.57	0.86	0.544	
3DB	53.5	53.5	76.5	72	80	3	4.5	1.5	1.5	18	0.40	1.48	0.81	0.493	
3DC	53.5	53.5	76.5	71	81	3	5.5	1.5	1.5	20	0.40	1.48	0.81	0.604	
3DE	53.5	52	76.5	69	82	5	7	1.5	1.5	22	0.39	1.56	0.86	0.795	
7FC	57	53	83	69	91	3	9	2	2	33	0.87	0.69	0.38	0.907	
2FB	55	58.5	91.5	84	93.5	3	5	2	1.5	21	0.35	1.74	0.96	1.01	
7FB	55	56.5	91.5	76	96.5	3	9	2	1.5	32.5	0.83	0.73	0.40	0.966	
2FD	55	56.5	91.5	80.5	93.5	3	8	2	1.5	25.5	0.35	1.74	0.96	1.45	
5FD	55	55.5	91.5	73.5	95	4	9	2.5	0.6	30	0.55	1.10	0.60	1.47	
2BC	54.5	55	67.5	63.5	69	3	3	0.6	0.6	13.5	0.34	1.76	0.97	0.192	
	54.5	56.5	67.5	63.5	69.5	3	3	0.6	0.6	14.5	0.36	1.67	0.92	0.193	
3CC	55.5	55.5	74.5	68.5	77.5	4	4.5	1	1	17.5	0.42	1.42	0.78	0.373	
2CE	55.5	56	74.5	69	76.5	4	5	1	1	17.5	0.32	1.90	1.04	0.44	
3CE	58.5	56.5	76.5	71	81.5	4	6	1.5	1.5	20.5	0.41	1.46	0.80	0.583	
3DB	58.5	58	81.5	76.5	85.5	3	4.5	1.5	1.5	19.5	0.42	1.43	0.79	0.56	
3DC	58.5	57.5	81.5	76	86	3	5.5	1.5	1.5	21	0.42	1.43	0.79	0.639	
3DE	58.5	56.5	81.5	73.5	87	5	7.5	1.5	1.5	23.5	0.41	1.45	0.80	0.862	
2ED	62	58	88	82	94.5	6	6	2	2	25.5	0.34	1.75	0.96	1.3	
7FC	64	59	91	82	94.5	4	10	2.5	2.5	36.5	0.87	0.69	0.38	1.22	
2FB	62	64.5	100	92.5	103	3	6	2	2	33	0.35	1.74	0.96	1.31	
7FB	62	61.5	100	83.5	104.5	3	10	2	2	35	0.83	0.73	0.40	1.25	
2FD	62	61.5	100	88	102.5	3	9	2	2	28.5	0.35	1.74	0.96	1.92	
5FD	62	61.5	100	80.5	104	3	9	2	2.5	33.5	0.55	1.1	0.60	1.97	
2BC	60.5	61	74.5	70.5	76.5	3	3	1	1	14.5	0.31	1.94	1.07	0.274	
3CC	63.5	63	81.5	77.5	87	4	5.5	1.5	1.5	20	0.41	1.48	0.81	0.56	
2CE	63.5	63	81.5	78	86	5	6	1.5	1.5	19.5	0.31	1.92	1.06	0.654	
3CE	63.5	62.5	86.5	80	91	5	7	1.5	1.5	22	0.37	1.60	0.88	0.858	
3DB	65	64	91.5	86	95.5	4	4.5	2	1.5	21	0.40	1.48	0.81	0.725	
3DC	65	63	91.5	85	96	4	5.5	2	1.5	22.5	0.40	1.48	0.81	0.873	
3DE	65	62.5	91.5	82	96.5	6	8	2	1.5	25.5	0.40	1.50	0.83	1.17	
7FC	69	65.5	101	83.5	110	4	10.5	2.5	2.5	43.5	0.87	0.69	0.38	1.57	
2FB	67	70.5	110	101	112	4	6.5	2	2	24.5	0.35	1.74	0.96	1.65	
7FB	67	67	110	91.5	113.5	4	10.5	2	2	38	0.83	0.73	0.40	1.58	
2FD	67	67.5	110	96.5	111.5	4	10.5	2	2	30.5	0.35	1.74	0.96	2.44	
5FD	67	67	110	88.5	113.5	4	10	2	2.5	36.5	0.55	1.10	0.60	2.47	

Metric series

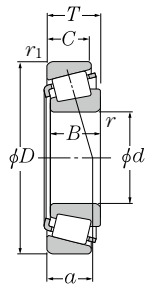

a 60 ~ 75mm

d	Boundary dimensions					Basic load rating		Fatigue load limit kN C _u	Allowable speed min ⁻¹		Bearing number ²⁾	
	mm					dynamic kN C _R	static C _{0r}		Grease lubrication	Oil lubrication		
	D	T	B	C	r _{s min} ¹⁾ r _{1s min} ¹⁾							
60	85	17	17	14	1	1	56.5	83.0	10.1	4 000	5 300	○32912XA
	95	23	23	17.5	1.5	1.5	91.0	123	—	3 700	4 900	4T-32012X
	95	27	27	21	1.5	1.5	104	145	—	3 700	4 900	4T-33012
	100	30	30	23	1.5	1.5	126	164	—	3 600	4 700	4T-33112
	110	23.75	22	19	2	1.5	116	125	—	3 400	4 500	4T-30212
	110	29.75	28	24	2	1.5	144	164	20.1	3 400	4 500	32212U
	110	38	38	29	2	1.5	179	223	27.1	3 400	4 500	33212U
	115	40	39	33	2.5	2.5	209	249	—	3 200	4 300	4T-T2EE060
	125	37	33.5	26	3	3	161	186	—	2 800	3 700	4T-T7FC060
	130	33.5	31	26	3	2.5	199	210	25.6	3 000	4 000	30312U
65	130	33.5	31	22	3	2.5	167	176	—	2 700	3 600	4T-30312D
	130	48.5	46	37	3	2.5	271	315	38.5	3 000	4 000	32312U
	130	48.5	46	37	3	2.5	237	296	—	2 900	3 900	4T-32312C
	90	17	17	14	1	1	53.5	85.0	10.4	3 700	4 900	32913XU
	100	23	23	17.5	1.5	1.5	92.0	128	—	3 400	4 600	4T-32013X
	100	27	27	21	1.5	1.5	108	156	—	3 400	4 600	4T-33013
	110	34	34	26.5	1.5	1.5	160	211	—	3 300	4 400	4T-33113
	120	24.75	23	20	2	1.5	136	148	—	3 100	4 200	4T-30213
	120	32.75	31	27	2	1.5	176	206	25.1	3 100	4 200	32213U
	120	41	41	32	2	1.5	216	265	32.5	3 100	4 200	33213U
70	140	36	33	28	3	2.5	225	238	28.7	2 800	3 700	30313U
	140	36	33	23	3	2.5	192	204	—	2 500	3 300	4T-30313D
	140	51	48	39	3	2.5	305	350	42.5	2 800	3 700	32313U
	100	20	20	16	1	1	76.0	110	13.4	3 400	4 600	32914XU
	110	25	25	19	1.5	1.5	116	160	—	3 200	4 200	4T-32014X
	110	31	31	25.5	1.5	1.5	140	204	—	3 200	4 200	4T-33014
	120	37	37	29	2.5	0.6	190	251	30.5	3 100	4 100	33114U
	125	26.25	24	21	2	1.5	146	162	—	2 900	3 900	4T-30214
	125	33.25	31	27	2	1.5	184	220	26.8	2 900	3 900	32214U
	125	41	41	32	2	1.5	223	282	34.5	2 900	3 900	33214U
75	140	39	35.5	27	3	3	191	231	—	2 400	3 200	4T-T7FC070
	150	38	35	30	3	2.5	255	272	32.0	2 600	3 500	30314U
	150	38	35	25	3	2.5	214	229	—	2 300	3 000	4T-30314D
	150	54	51	42	3	2.5	345	405	48.0	2 600	3 500	32314U
	150	54	51	42	3	2.5	300	380	45.0	2 500	3 300	32314CU

1) Smallest allowable dimension for chamfer dimension r or r₁.
2) Bearings with a ○ mark do not incorporate the subunit dimensions.

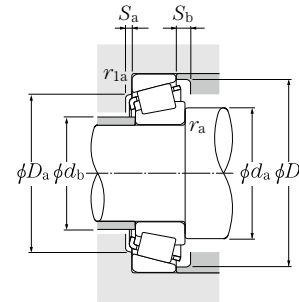

Dynamic equivalent radial load

$$P_r = X F_r + Y F_a$$

$\frac{F_a}{F_r} \leq e$		$\frac{F_a}{F_r} > e$	
X	Y	X	Y
1	0	0.4	Y ₂

Static equivalent radial load

$$P_{0r} = 0.5 F_r + Y_0 F_a$$

When $P_{0r} < F_r$ use $P_{0r} = F_r$.

For values of e, Y₂ and Y₀ see the table below.

ISO Dimension series	Installation-related dimensions									Load center mm a	Constant e	Axial load factors		Mass kg (approx.)
	d _a Min.	d _b Max.	D _a Max.	mm D _b Min.	S _a Min.	S _b Min.	r _{as} Max.	r _{1as} Max.	Y ₂			Y ₀		
4CC	65.5	66	79.5	76.5	82.5	3	3	1	1	15.5	0.33	1.80	0.99	0.281
	68.5	67.5	86.5	81.5	91.5	4	5.5	1.5	1.5	21	0.43	1.39	0.77	0.596
	68.5	67	86.5	82	90	5	6	1.5	1.5	20.5	0.33	1.83	1.01	0.693
	68.5	67	91.5	84.5	96.5	5	7	1.5	1.5	23.5	0.40	1.51	0.83	0.913
	70	69.5	101.5	94	103.5	4	4.5	2	1.5	22	0.40	1.48	0.81	0.929
	70	68.5	101.5	92	105	4	5.5	2	1.5	25	0.40	1.48	0.81	1.18
	70	68.5	101.5	90	105.5	6	9	2	1.5	27.5	0.40	1.48	0.82	1.53
	72	69.5	103	95	109	6	7	2	2	28.5	0.33	1.80	0.99	1.86
	74	71.5	111	92	120	4	11	2.5	2.5	42	0.82	0.73	0.40	2
	74	77	118	109.5	121.5	4	7.5	2.5	2	26.5	0.35	1.74	0.96	2.05
2FB	74	73	118	99	124	4	11.5	2.5	2	40.5	0.83	0.73	0.40	1.95
	74	73.5	118	106	121.5	4	11.5	2.5	2	32	0.35	1.74	0.96	3.01
	74	73	118	96.5	122	5	11	2.5	2	39	0.55	1.10	0.60	3.07
	70.5	70.5	84.5	80	86	3	3	1	1	16.5	0.35	1.70	0.93	0.315
	73.5	72.5	91.5	86	97	4	5.5	1.5	1.5	22.5	0.46	1.31	0.72	0.631
	73.5	72	91.5	87	95.5	5	6	1.5	1.5	21.5	0.35	1.72	0.95	0.742
	73.5	73	101.5	92.5	106.5	6	7.5	1.5	1.5	26	0.39	1.55	0.85	1.27
	75	77	111.5	103	114.5	4	4.5	2	1.5	23.5	0.40	1.48	0.81	1.18
	75	75.5	111.5	101.5	115.5	4	5.5	2	1.5	27	0.40	1.48	0.81	1.57
	75	74	111.5	99	115.5	7	9	2	1.5	29.5	0.39	1.54	0.85	2
2GB	79	83	128	119	131.5	4	8	2.5	2	28.5	0.35	1.74	0.96	2.54
	79	79	128	107.5	133	4	13	2.5	2	44	0.83	0.73	0.40	2.41
	79	79.5	128	115	131.5	4	12	2.5	2	34.5	0.35	1.74	0.96	3.63
	75.5	76.5	94.5	90	96.5	4	4	1	1	18	0.32	1.90	1.05	0.475
	78.5	78	101.5	94.5	105.5	5	6	1.5	1.5	24	0.43	1.38	0.76	0.863
	78.5	79	101.5	96.5	105.5	5	5.5	1.5	1.5	22.5	0.28	2.11	1.16	1.07
	80	79	111.5	101.5	115.5	6	8	2.5	0.6	28	0.38	1.58	0.87	1.68
	80	81	116.5	107.5	119	4	5	2	1.5	25.5	0.42	1.43	0.79	1.3
	80	79.5	116.5	105.5	120.5	4	6	2	1.5	28.5	0.42	1.43	0.79	1.68
	80	78.5	116.5	104	121.5	7	9	2	1.5	31	0.41	1.47	0.81	2.12
7FC	84	81.5	126	104.5	135	5	12	2.5	2.5	47.5	0.87	0.69	0.38	2.62
	84	88.5	138	128	141	4	8	2.5	2	30	0.35	1.74	0.96	3.05
	84	84.5	138	115.5	142.5	4	13	2.5	2	47	0.83	0.73	0.40	2.92
	84	85	138	122.5	141	4	12	2.5	2	36.5	0.35	1.74	0.96	4.44
	84	85	138	112.5	143	5	12	2.5	2	44	0.55	1.10	0.60	4.53

Metric series

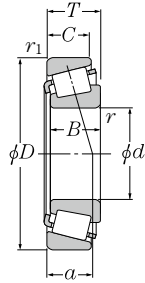

d 75 ~ 90mm

	Boundary dimensions					Basic load rating		Fatigue load limit kN C _u	Allowable speed min ⁻¹		Bearing number	
	d	D	T	B	C	dynamic C _R	static C _{0r}		Grease	Oil lubrication		
75	115	25	25	19	1.5	1.5	118	167	20.3	3 000	4 000	32015XU
	115	31	31	25.5	1.5	1.5	123	186	22.7	3 000	4 000	33015U
	130	27.25	25	22	2	1.5	154	175	—	2 700	3 600	4T-30215
	130	33.25	31	27	2	1.5	186	224	27.1	2 700	3 600	32215U
	130	41	41	31	2	1.5	231	298	36.0	2 700	3 600	33215U
	160	40	37	31	3	2.5	283	305	35.0	2 400	3 200	30315U
	160	40	37	26	3	2.5	238	256	29.8	2 100	2 800	30315DU
	160	58	55	45	3	2.5	395	470	54.5	2 400	3 200	32315U
160	58	55	45	3	2.5	365	480	56.0	2 300	3 100	32315CU	
80	110	20	20	16	1	1	79.5	121	14.8	3 000	4 000	32916XU
	125	29	29	22	1.5	1.5	154	216	26.1	2 800	3 700	32016XU
	125	36	36	29.5	1.5	1.5	192	284	34.5	2 800	3 700	33016U
	130	37	37	29	2.5	0.6	199	276	33.0	2 700	3 600	33116U
	140	28.25	26	22	2.5	2	177	200	23.7	2 500	3 400	30216U
	140	35.25	33	28	2.5	2	221	265	31.5	2 500	3 400	32216U
	140	46	46	35	2.5	2	278	365	43.5	2 500	3 400	33216U
	160	45	41	31	3	2	238	297	—	2 400	3 200	4T-T7FC080
	170	42.5	39	33	3	2.5	325	350	39.5	2 300	3 000	30316U
	170	42.5	39	27	3	2.5	262	283	32.5	2 000	2 700	30316DU
170	61.5	58	48	3	2.5	440	525	60.0	2 300	3 000	32316U	
170	61.5	58	48	3	2.5	390	505	58.0	2 200	2 900	32316CU	
85	120	23	23	18	1.5	1.5	104	157	19.1	2 800	3 800	32917XU
	130	29	29	22	1.5	1.5	157	224	26.7	2 600	3 500	32017XU
	130	36	36	29.5	1.5	1.5	195	296	35.5	2 600	3 500	33017U
	140	41	41	32	2.5	2.5	234	330	39.0	2 500	3 400	33117U
	150	30.5	28	24	2.5	2	203	232	27.0	2 400	3 200	30217U
	150	38.5	36	30	2.5	2	249	300	35.0	2 400	3 200	32217U
	150	49	49	37	2.5	2	315	420	49.0	2 400	3 200	33217U
	180	44.5	41	34	4	3	335	365	40.5	2 100	2 900	30317U
	180	44.5	41	28	4	3	274	293	33.0	1 900	2 500	30317DU
180	63.5	60	49	4	3	445	525	59.0	2 100	2 900	32317U	
180	63.5	60	49	4	3	435	575	64.5	2 100	2 700	32317CU	
90	125	23	23	18	1.5	1.5	108	168	20.0	2 700	3 600	32918XU
	140	32	32	24	2	1.5	187	270	31.5	2 500	3 300	32018XU
	140	39	39	32.5	2	1.5	238	360	42.0	2 500	3 300	33018U
	150	45	45	35	2.5	2.5	280	400	46.0	2 400	3 200	33118U

1) Smallest allowable dimension for chamfer dimension r or r₁.

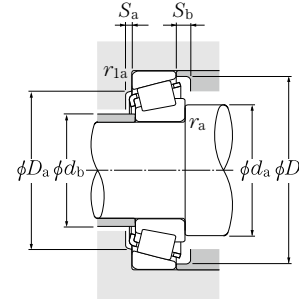

Dynamic equivalent radial load

$$P_r = XF_r + YF_a$$

$\frac{F_a}{F_r} \leq e$		$\frac{F_a}{F_r} > e$	
X	Y	X	Y
1	0	0.4	Y ₂

Static equivalent radial load

$$P_{0r} = 0.5F_r + Y_0F_a$$

When $P_{0r} < F_r$ use $P_{0r} = F_r$.

For values of e, Y₂ and Y₀ see the table below.

ISO Dimension series	Installation-related dimensions									Load center mm a	Constant e	Axial load factors		Mass kg (approx.)
	d _a Min.	d _b Max.	D _a Max.	mm Min.	S _a Min.	S _b Min.	r _{as} Max.	r _{1as} Max.	Y ₂			Y ₀		
4CC	83.5	83	106.5	99.5	111	5	6	1.5	1.5	25.5	0.46	1.31	0.72	0.912
2CE	83.5	85	106.5	101	110.5	6	5.5	1.5	1.5	23	0.30	2.01	1.11	1.11
4DB	85	85.5	121.5	112.5	124.5	4	5	2	1.5	27	0.44	1.38	0.76	1.4
4DC	85	84.5	121.5	111	126	4	6	2	1.5	30	0.44	1.38	0.76	1.74
3EE	85	83	121.5	107.5	125	7	10	2	1.5	32	0.43	1.40	0.77	2.23
2GB	89	95	148	137	150.5	4	9	2.5	2	32	0.35	1.74	0.96	3.61
7GB	89	91	148	124	152.5	6	14	2.5	2	50	0.83	0.73	0.40	3.46
2GD	89	91	148	131	150.5	4	13	2.5	2	39	0.35	1.74	0.96	5.4
5GD	89	90	148	119.5	152	6	15	2.5	2	47	0.55	1.10	0.60	5.65
2BC	85.5	86	104.5	99	106.5	4	4	1	1	20	0.35	1.71	0.94	0.54
3CC	88.5	89	116.5	108.5	120.5	6	7	1.5	1.5	27	0.42	1.42	0.78	1.28
2CE	88.5	88.5	116.5	108.5	119.5	6	6.5	1.5	1.5	25	0.28	2.16	1.19	1.61
3DE	90	88.5	121.5	110.5	126	6	15	2.5	2	30.5	0.42	1.44	0.79	1.87
3EB	92	91	130	121	133	4	6	2	2	27.5	0.42	1.43	0.79	1.71
3EC	92	90	130	119.5	134.5	4	7	2	2	31	0.42	1.43	0.79	2.17
3EE	92	89	130	116	135.5	7	11	2	2	35	0.43	1.41	0.78	2.94
7FC	94	94	146	119	153.5	6	15	2	2.5	55	0.87	0.69	0.38	3.92
2GB	94	101.5	158	145	160	4	9.5	2.5	2	34	0.35	1.74	0.96	4.41
7GB	94	97	158	131	160.5	6	15.5	2.5	2	53.5	0.83	0.73	0.40	4.17
2GD	94	97	158	138.5	161.5	4	13.5	2.5	2	41.5	0.35	1.74	0.96	6.48
5GD	94	96	158	127.5	162	4	13.5	2.5	2	50.5	0.55	1.10	0.60	6.61
2BC	93.5	92	111.5	107.5	115.5	4	5	1.5	1.5	21	0.33	1.83	1.01	0.773
4CC	93.5	93.5	121.5	113	126	6	7	1.5	1.5	28.5	0.44	1.36	0.75	1.34
2CE	93.5	94	121.5	114	125.5	6	6.5	1.5	1.5	26	0.29	2.06	1.13	1.69
3DE	97	95	130	118	135.5	7	9	2	2	33	0.41	1.48	0.81	2.44
3EB	97	96.5	140	128.5	141.5	5	6.5	2	2	30	0.42	1.43	0.79	2.13
3EC	97	96	140	127	143.5	5	8.5	2	2	33.5	0.42	1.43	0.79	2.75
3EE	97	95	140	124	144.5	7	12	2	2	37.5	0.42	1.43	0.79	3.61
2GB	103	106.5	166	153.5	168	5	10.5	3	2.5	35.5	0.35	1.74	0.96	5.01
7GB	103	102.5	166	140.5	170	6	16.5	3	2.5	56	0.83	0.73	0.40	4.74
2GD	103	103.5	166	147	169	5	14.5	3	2.5	43	0.35	1.74	0.96	7.22
5GD	103	102	166	135.5	170	7	13	2	2.5	53	0.55	1.10	0.60	7.71
2BC	98.5	97	116.5	112.5	120.5	4	5	1.5	1.5	22	0.34	1.75	0.96	0.815
3CC	100	100	131.5	121	134.5	6	8	2	1.5	30	0.42	1.42	0.78	1.78
2CE	100	100.5	131.5	123.5	135	7	6.5	2	1.5	28	0.27	2.23	1.23	2.22
3DE	102	101	140	127.5	145.5	7	10	2	2	35.5	0.40	1.51	0.83	3.1

Metric series

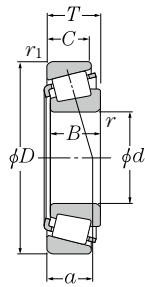

a 90 ~ 110mm

d	Boundary dimensions					Basic load rating		Fatigue load limit kN C _u	Allowable speed		Bearing number ²⁾	
	mm					dynamic	static		Grease lubrication	Oil lubrication		
	D	T	B	C	r _{s min} ¹⁾ r _{1s min} ¹⁾	C _r	C _{0r}					
90	160	32.5	30	26	2.5	2	230	267	30.5	2 200	3 000	30218U
	160	42.5	40	34	2.5	2	291	360	41.0	2 200	3 000	32218U
	160	55	55	42	2.5	2.5	360	490	56.0	2 300	3 000	33218U
	190	46.5	43	36	4	3	375	405	44.5	2 000	2 700	30318U
	190	46.5	43	30	4	3	300	320	35.5	1 800	2 400	30318DU
	190	67.5	64	53	4	3	500	595	65.5	2 000	2 700	32318U
95	130	23	23	18	1.5	1.5	112	178	21.0	2 500	3 400	32919XU
	145	32	32	24	2	1.5	190	280	32.5	2 300	3 100	32019XU
	145	39	39	32.5	2	1.5	243	375	43.0	2 300	3 100	33019U
	170	34.5	32	27	3	2.5	250	290	32.5	2 100	2 800	30219U
	170	45.5	43	37	3	2.5	330	415	47.0	2 100	2 800	32219U
	200	49.5	45	38	4	3	405	445	48.5	1 900	2 500	30319U
	200	49.5	45	32	4	3	330	355	38.5	1 700	2 200	30319DU
	200	71.5	67	55	4	3	560	670	73.0	1 900	2 500	32319U
100	140	25	25	20	1.5	1.5	134	206	23.8	2 400	3 200	32920XU
	140	25	24	20	1.5	1.5	108	162	18.6	2 400	3 200	32920
	145	24	22.5	17.5	3	3	119	153	—	1 800	2 400	4T-T4CB100
	150	32	32	24	2	1.5	188	281	32.0	2 200	3 000	32020XU
	150	39	39	32.5	2	1.5	248	390	44.5	2 200	3 000	33020U
	180	37	34	29	3	2.5	286	335	37.0	2 000	2 700	30220U
	180	49	46	39	3	2.5	365	465	51.0	2 000	2 700	32220U
	180	63	63	48	3	2.5	465	650	71.5	2 000	2 700	33220U
	215	51.5	47	39	4	3	455	500	53.0	1 800	2 400	30320U
	215	56.5	51	35	4	3	395	435	46.0	1 800	2 400	31320XU
	215	77.5	73	60	4	3	635	770	82.0	1 800	2 400	32320U
105	145	25	25	20	1.5	1.5	139	219	25.0	2 300	3 000	32921XA
	160	35	35	26	2.5	2	223	335	37.5	2 100	2 800	32021XU
	160	43	43	34	2.5	2	272	420	47.0	2 100	2 800	33021U
	190	39	36	30	3	2.5	320	380	41.0	1 900	2 500	30221U
	190	53	50	43	3	2.5	420	540	59.0	1 900	2 500	32221U
	225	53.5	49	41	4	3	485	535	56.0	1 700	2 300	30321U
	225	58	53	36	4	3	420	470	49.0	1 700	2 300	31321XU
	225	81.5	77	63	4	3	680	825	87.0	1 700	2 300	32321U
110	150	25	25	20	1.5	1.5	141	226	25.5	2 200	2 900	32922XA
	170	38	38	29	2.5	2	261	390	43.0	2 000	2 700	32022XU

1) Smallest allowable dimension for chamfer dimension r or r₁.
2) Bearings with a ○ mark do not incorporate the subunit dimensions.
B-144

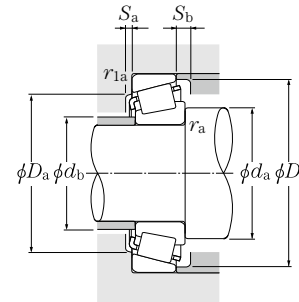

Dynamic equivalent radial load

$$P_r = X F_r + Y F_a$$

$\frac{F_a}{F_r} \leq e$		$\frac{F_a}{F_r} > e$	
X	Y	X	Y
1	0	0.4	Y ₂

Static equivalent radial load

$$P_{0r} = 0.5 F_r + Y_0 F_a$$

When $P_{0r} < F_r$ use $P_{0r} = F_r$.

For values of e, Y₂ and Y₀ see the table below.

ISO Dimension series	Installation-related dimensions									Load center mm	Constant	Axial load factors		Mass kg (approx.)			
	d _a	d _b	D _a		D _b		S _a	S _b	r _{as}			r _{1as}	a		e	Y ₂	Y ₀
	Min.	Max.	Max.	Min.	Min.	Min.	Min.	Min.	Max.			Max.					
3FB	102	103	150	137	151	5	6.5	2	2	32	0.42	1.43	0.79	2.66			
3FC	102	101.5	150	134.5	153.5	5	8.5	2	2	36	0.42	1.43	0.79	3.49			
3FE	102	101.5	150	131.5	154.5	9	13	2	2.5	41	0.42	1.43	0.78	4.62			
2GB	108	112.5	176	162	177.5	5	10.5	3	2.5	37.5	0.35	1.74	0.96	5.83			
7GB	108	108.5	176	148.5	180.5	6	16.5	3	2.5	59	0.83	0.73	0.40	5.58			
2GD	108	108.5	176	154.5	179	5	14.5	3	2.5	45.5	0.35	1.74	0.96	8.66			
2BC	103.5	102	121.5	117	125.5	4	5	1.5	1.5	23.5	0.36	1.68	0.92	0.851			
4CC	105	105	136.5	126	140	6	8	2	1.5	31.5	0.44	1.36	0.75	1.85			
2CE	105	104.5	136.5	127.5	139.5	7	6.5	2	1.5	28.5	0.28	2.16	1.19	2.3			
3FB	109	109.5	158	146.5	160.5	5	7.5	2.5	2	34	0.42	1.43	0.79	3.12			
3FC	109	107.5	158	142.5	163	5	8.5	2.5	2	39	0.42	1.43	0.79	4.29			
2GB	113	118	186	168	185.5	5	11.5	3	2.5	40	0.35	1.74	0.96	6.69			
7GB	113	113.5	186	154.5	189	6	17.5	3	2.5	62.5	0.83	0.73	0.40	6.35			
2GD	113	114.5	186	163.5	187.5	5	16.5	3	2.5	49	0.35	1.74	0.96	10.1			
2CC	108.5	109	131.5	127.5	135.5	4	5	1.5	1.5	24.5	0.33	1.82	1.00	1.12			
	108.5	110	131.5	127	135	4	5	1.5	1.5	25	0.35	1.73	0.95	1.08			
4CB	114	108.5	131	130	140.5	4	6.5	2.5	2.5	30	0.47	1.27	0.70	1.14			
4CC	110	109.5	141.5	130.5	145	6	8	2	1.5	32.5	0.46	1.31	0.72	1.91			
2CE	110	108.5	141.5	132.5	144.5	7	6.5	2	1.5	29.5	0.29	2.09	1.15	2.4			
3FB	114	115.5	168	154.5	169.5	5	8	2.5	2	36	0.42	1.43	0.79	3.76			
3FC	114	113.5	168	151	172	5	10	2.5	2	41.5	0.42	1.43	0.79	5.11			
3FE	114	113	168	147	173	10	15	2.5	2	45.5	0.40	1.48	0.82	6.76			
2GB	118	126	201	181.5	199.5	5	12.5	3	2.5	41.5	0.35	1.74	0.96	8.3			
7GB	118	122.5	201	165.5	203	7	21.5	3	2.5	69	0.83	0.73	0.40	8.7			
2GD	118	122.5	201	174.5	201.5	5	17.5	3	2.5	53	0.35	1.74	0.96	12.8			
	113.5	113.5	136.5	131.5	140.5	5	5	1.5	1.5	25	0.34	1.76	0.97	1.2			
4DC	117	115.5	150	138.5	153.5	6	9	2	2	34.5	0.44	1.35	0.74	2.44			
2DE	117	116	150	141.5	153.5	7	9	2	2	31	0.28	2.12	1.17	3			
3FB	119	121.5	178	163	178.5	6	9	2.5	2	38	0.42	1.43	0.79	4.45			
3FC	119	119	178	158.5	181.5	6	10	2.5	2	44	0.42	1.43	0.79	6.23			
2GB	123	132	211	190	208.5	6	12.5	3	2.5	43.5	0.35	1.74	0.96	9.37			
7GB	123	128.5	211	173.5	213.5	7	22	3	2.5	71.5	0.83	0.73	0.40	9.65			
2GD	123	129	211	182.5	210.5	6	18.5	3	2.5	55	0.35	1.74	0.96	14.7			
	118.5	118.5	141.5	136.5	146	5	5	1.5	1.5	26.5	0.36	1.69	0.93	1.24			
4DC	122	122	160	147.5	164	7	9	2	2	36.5	0.43	1.39	0.77	3.07			

Metric series

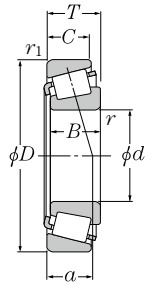

d 110 ~ 140mm

d	Boundary dimensions					Basic load rating		Fatigue load limit kN C _u	Allowable speed		Bearing number ^{2) 3)}	
	mm					dynamic	static		Grease	Oil		
	D	T	B	C	r _{s min} ¹⁾ r _{1s min} ¹⁾	C _r	C _{0r}		lubrication	lubrication		
110	170	47	47	37	2.5	2	320	500	55.5	2 000	2 700	33022U
	180	56	56	43	2.5	2.5	400	610	66.5	1 900	2 600	33122UE1
	200	41	38	32	3	2.5	360	435	46.5	1 800	2 400	30222U
	200	56	53	46	3	2.5	465	605	65.0	1 800	2 400	32222U
	240	54.5	50	42	4	3	530	585	60.0	1 600	2 200	30322U
	240	63	57	38	4	3	480	535	55.0	1 600	2 200	31322XU
240	84.5	80	65	4	3	785	970	99.5	1 600	2 200	32322U	
120	165	29	29	23	1.5	1.5	180	294	32.0	2 000	2 600	32924XU
	165	29	27	23	1.5	1.5	131	205	22.5	2 000	2 600	○ 32924
	170	27	25	19.5	3	2	171	235	—	1 900	2 600	4T-T4CB120
	180	38	38	29	2.5	2	272	420	45.5	1 800	2 500	32024XU
	180	48	48	38	2.5	2.5	325	520	56.5	1 800	2 500	33024U
	200	62	62	48	2.5	2.5	510	760	80.5	1 800	2 300	33124U
	215	43.5	40	34	3	2.5	385	470	49.0	1 700	2 200	30224U
	215	61.5	58	50	3	2.5	510	680	71.5	1 700	2 200	32224U
	260	59.5	55	46	4	3	620	695	69.5	1 500	2 000	30324U
	260	68	62	42	4	3	570	655	66.0	1 500	2 000	31324XU
260	90.5	86	69	4	3	905	1 130	114	1 500	2 000	32324U	
130	180	32	32	25	2	1.5	215	350	37.5	1 800	2 400	32926XU
	180	32	30	26	2	2	157	252	26.9	1 800	2 400	○ 32926
	200	45	45	34	2.5	2	350	545	57.0	1 700	2 200	32026XU
	200	55	55	43	2.5	2.5	415	660	69.5	1 700	2 300	33026U
	230	43.75	40	34	4	3	415	505	51.5	1 500	2 000	30226U
	230	67.75	64	54	4	3	585	815	83.5	1 500	2 000	32226U
	280	63.75	58	49	5	4	830	830	81.0	1 400	2 000	* 30326UUTG
	280	72	66	44	5	4	670	780	77.0	1 400	1 800	31326XU
280	98.75	93	78	4	4	1 140	1 240	122	1 400	2 000	* 32326UUTG	
140	190	32	32	25	2	1.5	221	375	39.0	1 700	2 200	32928XU
	195	29	27	21	3	3	208	299	—	1 700	2 200	4T-T4CB140
	210	45	45	34	2.5	2	365	580	60.0	1 600	2 100	32028XU
	210	56	56	44	2.5	2	435	715	74.0	1 600	2 100	33028U
	250	45.75	42	36	4	3	465	570	57.0	1 400	1 900	30228U
	250	71.75	68	58	4	3	675	920	92.0	1 400	1 900	32228U
	300	67.75	62	53	5	4	945	950	91.5	1 300	1 800	* 30328UUTG
	300	77	70	47	5	4	760	905	87.0	1 300	1 700	31328XU
300	107.75	102	85	4	4	1 270	1 370	132	1 300	1 800	* 32328UUTG	

1) Smallest allowable dimension for chamfer dimension r or r₁. 2) Bearings with a ○ mark do not incorporate the subunit dimensions.
3) Bearing numbers marked "*" designate ULTAGE series bearings.

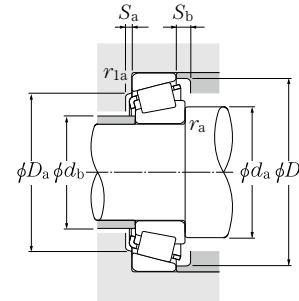

Dynamic equivalent radial load

$$P_r = X F_r + Y F_a$$

$\frac{F_a}{F_r} \leq e$		$\frac{F_a}{F_r} > e$	
X	Y	X	Y
1	0	0.4	Y ₂

Static equivalent radial load

$$P_{0r} = 0.5 F_r + Y_0 F_a$$

When $P_{0r} < F_r$ use $P_{0r} = F_r$.

For values of e, Y₂ and Y₀ see the table below.

ISO Dimension series	Installation-related dimensions									Load center mm a	Constant e	Axial load factors		Mass kg (approx.)	
	d _a	d _b	D _a		mm D _b		S _a	S _b	r _{as}			r _{1as}	Y ₂		Y ₀
	Min.	Max.	Max.	Min.	Min.	Min.	Min.	Min.	Max.			Max.			
2DE	122	121	160	148	162	7	10	2	2	33.5	0.29	2.09	1.15	3.84	
3FE	122	121.5	170	150.5	174	9	13	2	2.5	44	0.42	1.43	0.79	5.52	
3FB	124	128	188	170.5	188.5	6	9	2.5	2	40	0.42	1.43	0.79	5.19	
3FC	124	125.5	188	167	192	6	10	2.5	2	47	0.42	1.43	0.79	7.44	
2GB	128	141	226	203	222	6	12.5	3	2.5	45.5	0.35	1.74	0.96	11.1	
7GB	128	137	226	184	225.5	7	25	3	2.5	76	0.83	0.73	0.40	11.9	
2GD	128	136.5	226	195	224	6	19.5	3	2.5	57.5	0.35	1.74	0.96	17.6	
2CC	128.5	129.5	156.5	150	160	6	6	1.5	1.5	29.5	0.35	1.72	0.95	1.76	
	128.5	129.5	156.5	147.5	159.5	6	6	1.5	1.5	31	0.37	1.60	0.88	1.65	
4CB	134	128.5	156	153	165	7	7.5	2.5	2.5	35	0.47	1.27	0.70	1.69	
4DC	132	131	170	156	174.5	7	9	2	2	39	0.46	1.31	0.72	3.29	
2DE	132	130	170	157	172	6	10	2	2.5	36	0.31	1.97	1.08	4.14	
3FE	132	132.5	190	168	193	9	14	2	2.5	48	0.40	1.51	0.83	7.67	
4FB	134	139.5	203	184.5	203	6	9.5	2.5	2	44	0.44	1.38	0.76	6.32	
4FD	134	135.5	203	178	206	6	11.5	2.5	2	51.5	0.44	1.38	0.76	9.08	
2GB	138	153	246	218	239	6	13.5	3	2.5	49	0.35	1.74	0.96	14.1	
7GB	138	147	246	200	245	9	26	3	2.5	82.5	0.83	0.73	0.40	15.2	
2GD	138	146.5	246	210	240.5	6	21.5	3	2.5	61.5	0.35	1.74	0.96	22.1	
2CC	140	140.5	171.5	163	174	6	7	2	1.5	31.5	0.34	1.77	0.97	2.41	
	140	141.5	170	161.5	174	6	6	2	2	34	0.37	1.60	0.88	2.24	
4EC	142	144	190	173.5	193.5	8	11	2	2	43.5	0.43	1.38	0.76	5	
2FE	142	143	190	173.5	193	8	12	2	2.5	42.5	0.34	1.76	0.97	6.09	
4FB	148	151	216	199.5	218	7	9.5	3	2.5	45.5	0.44	1.38	0.76	7.05	
4FD	148	147	216	190	220.5	7	13.5	3	2.5	57	0.44	1.38	0.76	11.3	
2GB	152	165.5	262	235	257.5	8	14.5	4	3	53.5	0.35	1.74	0.96	17.4	
7GB	152	154	262	214.5	263	9	28	4	3	87.5	0.83	0.73	0.40	19	
	148	159	262	230	264	2.4	20	3	3	67.5	0.35	1.73	0.95	27.4	
2CC	150	150	181.5	172.5	184	6	6	2	1.5	34	0.36	1.67	0.92	2.5	
4CB	154	149	181	176	190	5	8	2.5	2.5	40.5	0.50	1.19	0.66	2.35	
4DC	152	153	200	182.5	203	8	11	2	2	46	0.46	1.31	0.72	5.32	
2DE	152	152	200	182.5	203	7	12	2	2	45.5	0.36	1.67	0.92	6.59	
4FB	158	163	236	214	235	7	9.5	3	2.5	48.5	0.44	1.38	0.76	8.73	
4FD	158	158.5	236	207	239.5	9	13.5	3	2.5	61	0.44	1.38	0.76	14.2	
2GB	162	175.5	282	252	275.5	9	14.5	4	3	56.5	0.35	1.74	0.96	21.1	
7GB	162	162.5	282	232	282.5	9	30	4	3	94	0.83	0.73	0.40	22.9	
	158	168.5	282	244	281	1.5	20	3	3	74.5	0.35	1.73	0.95	33.5	

Tapered Roller Bearings



Metric series

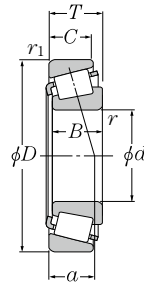

d 150 ~ 200mm

	Boundary dimensions					Basic load rating		Fatigue load limit kN C_u	Allowable speed min^{-1}		Bearing number ^{2) 3)}	
	d	D	T	B	C	dynamic kN C_r	static kN C_{0r}		Grease lubrication	Oil lubrication		
150	210	38	38	30	2.5	2	297	490	50.0	1 600	2 100	32930XU
	225	48	48	36	3	2.5	410	655	66.0	1 400	1 900	32030XU
	270	49	45	38	4	3	500	605	59.0	1 300	1 700	30230U
	270	77	73	60	4	3	775	1 070	105	1 300	1 700	32230U
	320	72	65	55	5	4	1 060	1 070	101	1 200	1 700	* 30330UUTG
	320	82	75	50	5	4	860	1 030	97.5	1 200	1 600	31330XU
	320	114	108	90	4	4	1 490	1 750	166	1 200	1 700	* 32330UUTG
160	220	38	38	30	2.5	2	305	520	52.5	1 500	1 900	32932XU
	240	51	51	38	3	2.5	485	790	78.5	1 400	1 800	32032XU
	290	52	48	40	4	3	675	720	68.5	1 200	1 700	* 30232UUTG
	290	84	80	67	4	3	1 140	1 420	136	1 200	1 700	* 32232UUTG
	340	75	68	58	5	4	1 170	1 200	110	1 100	1 600	* 30332UUTG
	340	121	114	95	4	4	1 580	1 840	170	1 100	1 600	* 32332UUTG
170	230	38	38	30	2.5	2	315	560	55.0	1 400	1 800	32934XU
	260	57	57	43	3	2.5	555	895	86.5	1 300	1 700	32034XU
	310	57	52	43	5	4	780	845	79.5	1 100	1 600	* 30234UUTG
	310	91	86	71	5	4	1 280	1 600	150	1 100	1 600	* 32234UUTG
	360	80	72	62	5	4	1 290	1 320	120	1 000	1 500	* 30334UUTG
	360	127	120	100	4	4	1 680	1 940	177	1 000	1 500	* 32334UUTG
180	250	45	45	34	2.5	2	390	700	68.0	1 300	1 700	32936XU
	280	64	64	48	3	2.5	825	1 170	111	1 200	1 700	* 32036XUUTG
	320	57	52	43	5	4	805	890	82.5	1 100	1 500	* 30236UUTG
	320	91	86	71	5	4	1 320	1 690	157	1 100	1 500	* 32236UUTG
	380	83	75	64	4	4	1 170	1 190	107	960	1 400	* 30336UUTG
	380	134	126	106	4	4	1 850	2 150	192	960	1 400	* 32336UUTG
190	260	45	45	34	2.5	2	390	710	68.0	1 200	1 600	32938XU
	260	45	42	36	2.5	2.5	310	525	50.5	1 200	1 600	○ 32938
	290	64	64	48	3	2.5	840	1 210	113	1 100	1 600	* 32038XUUTG
	340	60	55	46	5	4	920	1 000	91.5	1 000	1 400	* 30238UUTG
	340	97	92	75	5	4	1 480	1 850	169	1 000	1 400	* 32238UUTG
	400	86	78	65	5	5	1 200	1 200	106	900	1 300	* 30338UUTG
400	140	132	109	5	5	2 040	2 390	211	900	1 300	* 32338UUTG	
200	280	51	51	39	3	2.5	620	895	84.0	1 100	1 600	* 32940XUUTG
	310	70	70	53	3	2.5	1 030	1 470	135	1 100	1 500	* 32040XUUTG

1) Smallest allowable dimension for chamfer dimension r or r_1 . 2) Bearings with a ○ mark do not incorporate the subunit dimensions.
3) Bearing numbers marked "*" designate ULTAGE series bearings.

Tapered Roller Bearings

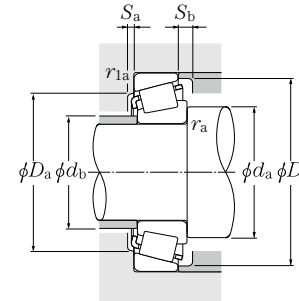

Dynamic equivalent radial load

$$P_r = X F_r + Y F_a$$

$\frac{F_a}{F_r} \leq e$		$\frac{F_a}{F_r} > e$	
X	Y	X	Y
1	0	0.4	Y ₂

Static equivalent radial load

$$P_{0r} = 0.5 F_r + Y_0 F_a$$

When $P_{0r} < F_r$ use $P_{0r} = F_r$.

For values of e , Y_2 and Y_0 see the table below.

ISO Dimension series	Installation-related dimensions										Load center mm a	Constant e	Axial load factors		Mass kg (approx.)
	d_a Min.	d_b Max.	D_a Max.	D_b Min.	S_a Min.	S_b Min.	r_{as} Max.	r_{1as} Max.	Y_2	Y_0					
2DC	162	162	200	189.5	202	7	8	2	2	36.5	0.33	1.83	1.01	3.93	
4EC	164	164	213	195	217.5	8	12	2.5	2	49.5	0.46	1.31	0.72	6.45	
4GB	168	175	256	230	251.5	7	11	3	2.5	51.5	0.44	1.38	0.76	11	
4GD	168	169	256	222	256	8	17	3	2.5	64.5	0.44	1.38	0.76	18	
2GB	172	188.5	302	270	294	8	17	4	3	61	0.35	1.74	0.96	25.4	
7GB	172	173.5	302	248	302	9	32	4	3	100.5	0.83	0.73	0.40	27.7	
	168	182.5	302	254	298	4.3	24	3	3	80	0.37	1.60	0.88	42.1	
2DC	172	172	210	199	213	7	8	2	2	38.5	0.35	1.73	0.95	4.14	
4EC	174	174.5	228	208	231.5	8	13	2.5	2	52.5	0.46	1.31	0.72	7.86	
4GB	178	188.5	276	248	271	8	12	3	2.5	55.5	0.44	1.38	0.76	13.4	
4GD	178	181	276	238	277	10	17	3	2.5	70	0.44	1.38	0.76	23.9	
2GB	182	200.5	322	286.5	312.5	10	17	4	3	64	0.35	1.74	0.96	29.8	
	178	196.5	322	272	318.5	2.3	26	3	3	85	0.37	1.60	0.88	48.9	
3DC	182	181	220	208	223.5	7	8	2	2	42.5	0.38	1.56	0.86	4.4	
4EC	184	187	248	224.5	250	10	14	2.5	2	56	0.44	1.35	0.74	10.6	
4GB	192	202	292	265.5	290.5	8	14	4	3	60.5	0.44	1.38	0.76	16.9	
4GD	192	194	292	255	297	10	20	4	3	75	0.44	1.38	0.76	29.2	
2GB	192	212.5	342	305	332.5	10	18	4	3	68	0.35	1.74	0.96	35.2	
	188	208	342	287	336	1.5	27	3	3	89.5	0.37	1.60	0.88	56.5	
4DC	192	192	240	219.5	241.5	8	11	2	2	54	0.48	1.25	0.69	6.55	
3FD	194	199	268	243	269	10	16	2.5	2	59.5	0.42	1.42	0.78	14.5	
4GB	202	210.5	302	274	299.5	9	14	4	3	63	0.45	1.33	0.73	17.8	
4GD	202	202	302	263	305.5	10	20	4	3	77.5	0.45	1.33	0.73	30.4	
	198	227.5	362	314	345	1.5	19	3	3	72.5	0.37	1.60	0.88	38.9	
	198	219	362	305	357	2.4	28	3	3	95	0.37	1.60	0.88	67.7	
4DC	202	201.5	250	230	251	8	11	2	2	55	0.48	1.26	0.69	6.82	
	202	205	248	233	250.5	8	9	2	2	48.5	0.37	1.60	0.88	6.27	
4FD	204	206.5	278	252	281	10	16	2.5	2	62.5	0.44	1.36	0.75	15	
4GB	212	223	322	293	320.5	9	14	4	3	64	0.44	1.38	0.76	21.5	
4GD	212	214	322	283	325.5	11	22	4	3	87.5	0.44	1.38	0.76	36.1	
	212	241	378	335	366.5	2.3	21	4	4	74.5	0.37	1.60	0.88	43.6	
	212	233	378	320	373.5	1.5	31	4	4	100	0.37	1.60	0.88	77	
3EC	214	213.5	268	251.5	272	9	12	2.5	2	53.5	0.39	1.52	0.84	9.28	
4FD	214	218.5	298	269	298.5	11	17	2.5	2	66.5	0.43	1.39	0.77	19.2	

Metric series

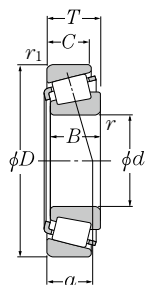

a 200 ~ 320mm

d	Boundary dimensions					Basic load rating		Fatigue load limit kN C _u	Allowable speed min ⁻¹		Bearing number ^{2) 3)}	
	mm					dynamic	static		Grease lubrication	Oil lubrication		
	D	T	B	C	r _{s min¹⁾} r _{1s min¹⁾}	C _r	C _{0r}					
200	360	64	58	48	5	4	1 010	1 110	99.0	950	1 300	* 30240UTG
	360	104	98	82	5	4	1 690	2 130	191	950	1 300	* 32240UTG
	420	89	80	67	5	5	1 340	1 370	119	850	1 200	* 30340UTG
	420	146	138	115	5	5	2 240	2 650	230	850	1 200	* 32340UTG
220	300	51	51	39	3	2.5	615	950	87.0	1 000	1 500	* 32944XUUTG
	300	51	48	41	2.5	2.5	385	670	61.0	1 000	1 400	○ 32944E1
	340	76	76	57	4	3	1 180	1 690	152	960	1 400	* 32044XUUTG
	400	72	65	54	4	4	1 050	1 220	106	840	1 200	* 30244UTG
	400	114	108	90	4	4	1 780	2 410	209	840	1 200	* 32244UTG
	460	97	88	73	5	5	1 620	1 690	142	770	1 100	* 30344UTG
240	460	154	145	122	5	5	2 590	3 050	259	770	1 100	* 32344UTG
	320	51	51	39	3	2.5	625	1 000	90.0	940	1 300	* 32948XUUTG
	360	76	76	57	4	3	1 190	1 760	154	870	1 200	* 32048XUUTG
	440	79	72	60	4	4	1 250	1 480	125	760	1 100	* 30248UTG
	440	127	120	100	4	4	2 180	2 750	232	760	1 100	* 30348UTG
260	500	105	95	80	5	5	1 900	2 000	165	690	990	* 30348UTG
	360	63.5	63.5	48	3	2.5	905	1 430	124	860	1 200	* 32952XUUTG
	400	87	87	65	5	4	1 540	2 270	193	800	1 100	* 32052XUUTG
	480	89	80	67	5	5	1 500	1 810	149	690	990	* 30252UTG
280	480	137	130	106	5	5	2 410	3 350	275	690	990	* 32252UTG
	380	63.5	63.5	48	3	2.5	930	1 520	129	790	1 100	* 32956XUUTG
	420	87	87	65	5	4	1 570	2 350	197	740	1 000	* 32056XUUTG
	500	89	80	67	5	5	1 590	1 910	155	630	900	* 30256UTG
300	500	137	130	106	5	5	2 530	3 500	283	630	900	* 32256UTG
	420	76	76	57	4	3	1 290	2 090	173	720	1 000	* 32960XUUTG
	460	100	100	74	5	4	1 920	2 830	232	680	960	* 32060XUUTG
	540	96	85	71	5	5	1 820	2 220	176	580	830	* 30260UTG
320	540	149	140	115	5	5	2 950	4 100	325	580	830	* 32260UTG
	440	76	76	57	4	3	1 300	2 150	176	670	960	* 32964XUUTG
	440	76	72	63	3	3	955	1 880	153	670	900	○ 32964E1
	480	100	100	74	5	4	1 940	2 940	237	630	900	* 32064XUUTG
	580	104	92	75	5	5	2 130	2 580	201	540	770	* 30264UTG
580	159	150	125	5	5	3 350	4 650	360	540	770	* 32264UTG	

1) Smallest allowable dimension for chamfer dimension r or r₁. 2) Bearings with a ○ mark do not incorporate the subunit dimensions.
3) Bearing numbers marked "*" designate ULTAGE series bearings.

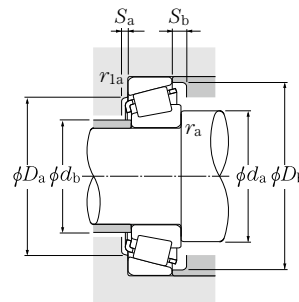

Dynamic equivalent radial load

$$P_r = X F_r + Y F_a$$

$\frac{F_a}{F_r} \leq e$	X	Y
	1	0
$\frac{F_a}{F_r} > e$	X	Y
	0.4	Y ₂

Static equivalent radial load

$$P_{0r} = 0.5 F_r + Y_0 F_a$$

When $P_{0r} < F_r$ use $P_{0r} = F_r$.

For values of e, Y₂ and Y₀ see the table below.

ISO Dimension series	Installation-related dimensions									Load center mm	Constant	Axial load factors		Mass kg (approx.)			
	d _a	d _b	D _a		mm D _b		S _a	S _b	r _{as}			r _{1as}	a		e	Y ₂	Y ₀
	Min.	Max.	Max.	Min.	Min.	Min.	Min.	Min.	Max.			Max.					
4GB	222	235	342	311	338	10	16	4	3	70	0.44	1.38	0.76	25.2			
3GD	222	224.5	342	299	342.5	11	22	4	3	85	0.41	1.48	0.81	43.8			
	222	251	398	350	382.5	5.3	22	4	4	77	0.37	1.60	0.88	51.5			
	222	242	398	335	391.5	3.2	31	4	4	105	0.37	1.60	0.88	89.6			
	3EC	234	233.5	288	269.5	291	10	12	2.5	2	59.5	0.43	1.41	0.78	9.98		
	232	238	288	270	291	10	10	2	2	57	0.39	1.55	0.85	9.47			
	4FD	238	239.5	326	293.5	326	12	19	3	2.5	72.5	0.43	1.39	0.77	24.9		
	238	262.5	382	334	368	3.4	18	3	3	82	0.49	1.23	0.68	34.8			
	238	249	382	323	380.5	4.4	24	3	3	102	0.49	1.23	0.68	59.8			
	242	270	438	383	418.5	4.2	24	4	4	86.5	0.37	1.60	0.88	66.6			
	242	262.5	438	371	431	1.5	32	4	4	112	0.37	1.60	0.88	110			
4EC	254	252.5	308	289	312.5	10	12	2.5	2	65.5	0.46	1.31	0.72	10.9			
4FD	258	258.5	346	311.5	347	12	19	3	2.5	78	0.46	1.31	0.72	26.5			
	258	284.5	422	368	406	3.9	19	3	3	91	0.49	1.23	0.68	47.7			
	258	270.5	422	365	421.5	4.1	27	3	3	107	0.43	1.39	0.77	78.9			
	262	294.5	478	417	456	8.1	25	4	4	94	0.37	1.60	0.88	88.3			
3EC	274	278	348	323	348.5	11	15	2.5	2	69.5	0.41	1.48	0.81	18.7			
4FC	282	283.5	382	346	383	14	22	4	3	85.5	0.43	1.38	0.76	39			
	282	307	458	396	438.5	4.2	22	4	4	99.5	0.49	1.23	0.68	63.4			
	282	297	458	385	453	2.9	31	4	4	121.5	0.49	1.23	0.68	100			
4EC	294	297	368	341.5	369.5	11	15	2.5	2	75	0.43	1.39	0.76	19.9			
4FC	302	301	402	363	403	14	22	4	3	90.5	0.46	1.31	0.72	40.5			
	302	324.5	478	422	464.5	5.9	22	4	4	102	0.49	1.23	0.68	66.5			
	302	312	478	405	473	6.4	31	4	4	123.5	0.49	1.23	0.68	110			
3FD	318	322	406	377.5	406.5	13	19	3	2.5	80	0.39	1.52	0.84	31.4			
4GD	322	324.5	442	398.5	441.5	15	26	4	3	98	0.43	1.38	0.76	57.2			
	322	349.5	518	453	498	4.9	25	4	4	111	0.49	1.23	0.68	83.5			
	322	339	518	438	511.5	2.6	34	4	4	135.5	0.49	1.23	0.68	140			
3FD	338	341	426	395.5	427	13	19	3	2.5	85	0.42	1.44	0.79	32.8			
	334	345.5	426	392	424.5	13	13	3	2.5	85	0.39	1.55	0.85	33.2			
4GD	342	344.5	462	418.5	463	15	26	4	3	104	0.46	1.31	0.72	60.2			
	342	372	558	485	531.5	4.7	29	4	4	118.5	0.47	1.27	0.70	100			
	342	363	558	473	551	3.9	34	4	4	142	0.47	1.27	0.70	170			

Metric series

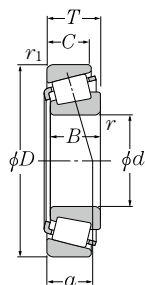

d 340 ~ 440mm

	Boundary dimensions						Basic load rating		Fatigue load limit kN C_u	Allowable speed min^{-1}		Bearing number ^{2) 3)}
	d	D	T	B	C	$r_s \text{ min}^{1)}$	$r_{1s} \text{ min}^{1)}$	dynamic kN C_r		static C_{0r}	Grease lubrication	
340	460	76	76	57	4	3	1 340	2 270	183	630	900	* 32968XUUTG
	460	76	72	63	3	3	1 010	1 980	159	630	900	○ 32968E1
	520	112	106	90	5	5	2 120	3 150	249	590	840	* 32068UTG
360	480	76	76	57	4	3	1 350	2 330	185	590	840	* 32972XUUTG
	540	112	106	90	5	5	2 230	3 300	258	550	780	* 32072UTG
380	520	87	82	72	4	4	1 460	2 500	194	550	790	* 32976UTG
	560	112	106	90	5	5	2 460	3 800	292	520	740	* 32076UTG
400	540	87	82	71	4	4	1 530	2 710	207	520	740	* 32980UTG
	600	125	118	100	5	5	2 790	4 250	320	490	700	* 32080UTG
420	560	87	82	71	4	4	1 570	2 840	215	490	700	* 32984UTG
	620	125	118	100	6	5	2 920	4 550	340	460	660	* 32084UTG
440	600	100	95	82	4	4	2 060	3 450	258	470	670	* 32988UTG
	650	130	122	104	6	6	3 250	5 000	365	440	620	* 32088UTG

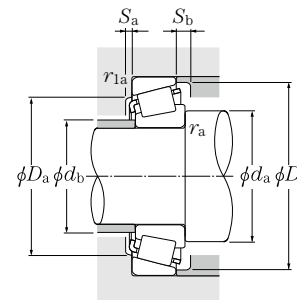

Dynamic equivalent radial load

$$P_r = X F_r + Y F_a$$

$\frac{F_a}{F_r} \leq e$		$\frac{F_a}{F_r} > e$	
X	Y	X	Y
1	0	0.4	Y_2

Static equivalent radial load

$$P_{0r} = 0.5 F_r + Y_0 F_a$$

When $P_{0r} < F_r$ use $P_{0r} = F_r$.

For values of e , Y_2 and Y_0 see the table below.

ISO Dimension series	Installation-related dimensions									Load center mm a	Constant e	Axial load factors		Mass kg (approx.)
	d_a Min.	d_b Max.	D_a Max.	mm D_b Min.	S_a Min.	S_b Min.	r_{as} Max.	r_{1as} Max.	Y_2			Y_0		
4FD	358	360	446	414	447.5	13	19	3	2.5	90.5	0.44	1.37	0.75	34.5
	354	364	446	413	445.5	13	13	3	2.5	87	0.39	1.55	0.85	34
	362	368.5	498	452	496	3.5	22	4	4	103.5	0.37	1.60	0.88	78.5
4FD	378	379.5	466	431.5	467.5	13	19	3	2.5	96.5	0.46	1.31	0.72	36.3
	382	388	518	476	520	5.5	22	4	4	106	0.37	1.60	0.88	83
	398	404.5	502	464.5	503	4	15	3	3	101	0.40	1.49	0.82	51.3
	402	406.5	538	495	539	6.5	22	4	4	109.5	0.37	1.60	0.88	89.1
	418	422.5	522	482	521.5	4	16	3	3	106	0.42	1.43	0.79	54
	422	428.5	578	526	575	5	25	4	4	119	0.37	1.60	0.88	110
	438	442	542	501.5	543	3.5	16	3	3	111.5	0.44	1.37	0.76	56.2
	448	449.5	598	549	598	6.5	25	4	4	120	0.37	1.60	0.88	120
	458	465.5	582	543	580.5	3.5	18	3	3	106	0.35	1.70	0.93	76
	468	469.5	622	576.5	627.5	5	26	5	5	127	0.37	1.60	0.88	140

1) Smallest allowable dimension for chamfer dimension r or r_1 . 2) Bearings with a ○ mark do not incorporate the subunit dimensions.
3) Bearing numbers marked "*" designate ULTAGE series bearings.

Inch series

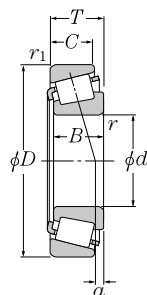

d 12.700 ~ 22.225mm

d	Boundary dimensions				Basic load rating		Allowable speed	
	D	T	B	C	dynamic C_r kN	static C_{0r}	Grease lubrication min ⁻¹	Oil lubrication
12.700	34.988	10.998	10.988	8.730	13.7	11.6	12 000	16 000
14.989	34.988	10.998	10.988	8.730	13.7	11.6	12 000	16 000
15.875	41.275	14.288	14.681	11.112	22.6	18.7	10 000	13 000
	42.862	14.288	14.288	9.525	19.5	17.5	8 700	12 000
	42.862	16.670	16.670	13.495	29.6	26.0	9 800	13 000
	47.000	14.381	14.381	11.112	26.6	24.2	8 600	11 000
	49.225	19.845	21.539	14.288	42.5	39.0	8 500	11 000
16.993	47.000	14.381	14.381	11.112	26.6	24.2	8 600	11 000
17.462	39.878	13.843	14.605	10.668	26.4	24.2	10 000	13 000
19.050	39.992	12.014	11.153	9.525	14.2	12.8	10 000	13 000
	45.237	15.494	16.637	12.065	31.5	28.6	8 900	12 000
	47.000	14.381	14.381	11.112	26.6	24.2	8 600	11 000
	49.225	18.034	19.050	14.288	42.5	39.0	8 500	11 000
	49.225	19.845	21.539	14.288	42.5	39.0	8 500	11 000
	49.225	21.209	19.050	17.462	42.5	39.0	8 500	11 000
	53.975	22.225	21.839	15.875	44.5	39.0	8 000	11 000
56.896	19.368	19.837	15.875	47.5	46.5	7 200	9 600	
19.987	47.000	14.381	14.381	11.112	26.6	24.2	8 600	11 000
20.000	50.005	13.495	14.260	9.525	28.8	27.9	7 500	10 000
20.625	49.225	19.845	21.539	14.288	42.5	39.0	8 500	11 000
20.638	49.225	19.845	19.845	15.875	41.5	39.0	8 200	11 000
21.430	50.005	17.526	18.288	13.970	42.0	39.0	8 000	11 000
21.986	45.974	15.494	16.637	12.065	33.0	34.0	8 400	11 000
22.225	50.005	13.495	14.260	9.525	28.8	27.9	7 500	10 000
	50.005	17.526	18.288	13.970	42.0	39.0	8 000	11 000
	52.388	19.368	20.168	14.288	45.0	43.0	7 600	10 000
	53.975	19.368	20.168	14.288	45.0	43.0	7 600	10 000

Note: Chamfer dimensions on the back face of the inner and outer rings of the bearing are larger than the maximum values of installation-related dimensions r_{as} and r_{1as} .

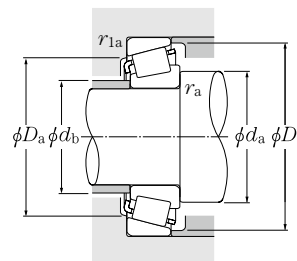

Dynamic equivalent radial load

$$P_r = X F_r + Y F_a$$

$\frac{F_a}{F_r} \leq e$		$\frac{F_a}{F_r} > e$	
X	Y	X	Y
1	0	0.4	Y_2

Static equivalent radial load

$$P_{0r} = 0.5 F_r + Y_0 F_a$$

When $P_{0r} < F_r$ use $P_{0r} = F_r$.

For values of e , Y_2 and Y_0 see the table below.

Bearing number ¹⁾	Installation-related dimensions						Load center mm	Constant e	Axial load factors		Mass kg (approx.)
	d_a	d_b	D_a	D_b	r_{as} Max.	r_{1as} Max.			Y_2	Y_0	
4T-A4050/A4138	18.5	17	29	32	1.3	1.3	2.5	0.45	1.32	0.73	0.053
4T-A4059†/A4138	19.5	19	29	32	0.8	1.3	2.5	0.45	1.32	0.73	0.049
4T-03062/03162	21.5	20	34	37.5	1.3	2	5.4	0.31	1.93	1.06	0.093
4T-11590/11520	24.5	22.5	34.5	39.5	1.5	1.5	1.2	0.70	0.85	0.47	0.103
4T-17580/17520	23	21	36.5	39	1.5	1.5	5.8	0.33	1.81	1.00	0.123
4T-05062/05185	23.5	21	40.5	42.5	1.5	1.3	4.2	0.36	1.68	0.92	0.131
4T-09062/09195	22	21.5	42	44.5	0.8	1.3	9.4	0.27	2.26	1.24	0.203
4T-05066/05185	24.5	22	40.5	42.5	1.5	1.3	4.2	0.36	1.68	0.92	0.13
4T-LM11749/LM11710	24	22	34	37	1.3	1.3	5.3	0.29	2.10	1.15	0.084
4T-A6075/A6157	24	23	34	37	1	1.3	1.5	0.53	1.14	0.63	0.065
4T-LM11949/LM11910	25	23.5	39.5	41.5	1.3	1.3	5.6	0.30	2.00	1.10	0.123
4T-05075/05185	25	23.5	40.5	42.5	1.3	1.3	4.2	0.36	1.68	0.92	0.121
4T-09067/09195	25.5	24	42	44.5	1.3	1.3	7.6	0.27	2.26	1.24	0.179
4T-09078/09195	25.5	24	42	44.5	1.3	1.3	9.4	0.27	2.26	1.24	0.19
4T-09067/09196	25.5	24	41.5	44.5	1.3	1.5	7.6	0.27	2.26	1.24	0.198
4T-21075/21212††	31.5	26	43	50	1.5	2.3	5.6	0.59	1.02	0.56	0.248
4T-1775/1729	27	25	49	51	1.5	1.3	6.5	0.31	1.95	1.07	0.268
4T-05079†/05185	26.5	24	40.5	42.5	1.5	1.3	4.2	0.36	1.68	0.92	0.118
4T-07079/07196	27.5	26	44.5	47	1.5	1	3.0	0.40	1.49	0.82	0.138
4T-09081/09195	27.5	25.4	42	44.5	1.5	1.3	9.4	0.27	2.26	1.24	0.18
4T-12580/12520	28.5	26	42.5	45.5	1.5	1.5	7.1	0.32	1.86	1.02	0.183
4T-M12649/M12610	29.5	27.5	44	46	1.3	1.3	6.4	0.28	2.16	1.19	0.169
4T-LM12749†/LM12711††	27.5	26	40	42.5	1.3	1.3	5.4	0.31	1.96	1.08	0.123
4T-07087/07196	28.5	27	44.5	47	1.3	1	3.0	0.40	1.49	0.82	0.128
4T-M12648/M12610	28.5	26.5	44	46	1.3	1.3	6.4	0.28	2.16	1.19	0.165
4T-1380/1328	29.5	27	45	48.5	1.5	1.5	7.4	0.29	2.05	1.13	0.196
4T-1380/1329††	29.5	27	46	49	1.5	1.5	7.4	0.29	2.05	1.13	0.22

1) As for the maximum value for inner and outer ring diameters of bearings whose bearing numbers are marked with "†" (inner ring) and "††" (outer ring), the precision class is an integer for class 4 and class 2 bearings only.

Inch series

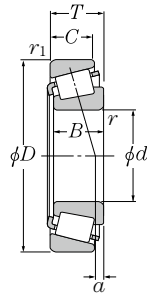

d 22.225 ~ 28.575mm

d	Boundary dimensions				Basic load rating		Allowable speed	
	D	T	B	C	dynamic C _r	static C _{0r}	Grease lubrication	Oil lubrication
22.225	56.896	19.368	19.837	15.875	47.5	46.5	7 200	9 600
	57.150	22.225	22.225	17.462	52.5	49.5	7 100	9 500
22.606	47.000	15.500	15.500	12.000	30.5	32.5	8 200	11 000
23.812	50.005	13.495	14.260	9.525	28.8	27.9	7 500	10 000
	50.292	14.224	14.732	10.668	32.0	34.0	7 400	9 900
	56.896	19.368	19.837	15.875	47.5	46.5	7 200	9 600
24.981	50.005	13.495	14.260	9.525	28.8	27.9	7 500	10 000
25.000	50.005	13.495	14.260	9.525	28.8	27.9	7 500	10 000
25.159	50.005	13.495	14.260	9.525	28.8	27.9	7 500	10 000
25.400	50.005	13.495	14.260	9.525	28.8	27.9	7 500	10 000
	50.005	13.495	14.260	9.525	28.8	27.9	7 500	10 000
	50.292	14.224	14.732	10.668	32.0	34.0	7 400	9 900
	51.994	15.011	14.260	12.700	28.8	27.9	7 500	10 000
	56.896	19.368	19.837	15.875	47.5	46.5	7 200	9 600
	57.150	19.431	19.431	14.732	47.0	48.5	6 900	9 200
	61.912	19.050	20.638	14.288	52.0	54.0	6 100	8 200
	62.000	19.050	20.638	14.288	52.0	54.0	6 100	8 200
	62.000	19.050	20.638	14.288	52.0	54.0	6 100	8 200
	64.292	21.433	21.433	16.670	57.5	64.5	6 100	8 100
65.088	22.225	21.463	15.875	52.0	50.5	5 700	7 600	
66.421	23.812	25.433	19.050	71.5	72.5	6 200	8 200	
26.157	62.000	19.050	20.638	14.288	52.0	54.0	6 100	8 200
26.162	66.421	23.812	25.433	19.050	71.5	72.5	6 200	8 200
26.988	50.292	14.224	14.732	10.668	32.0	34.0	7 400	9 900
	60.325	19.842	17.462	15.875	44.0	45.5	6 700	8 900
	62.000	19.050	20.638	14.288	52.0	54.0	6 100	8 200
	66.421	23.812	25.433	19.050	71.5	72.5	6 200	8 200
28.575	56.896	19.845	19.355	15.875	45.0	44.5	6 700	8 900
	57.150	17.462	17.462	13.495	44.0	45.5	6 700	8 900

Note: Chamfer dimensions on the back face of the inner and outer rings of the bearing are larger than the maximum values of installation-related dimensions r_{as} and r_{1as} .

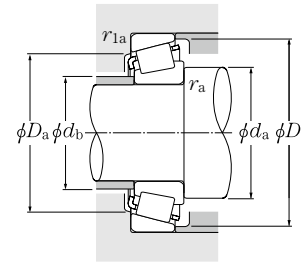

Dynamic equivalent radial load

$$P_r = X F_r + Y F_a$$

$\frac{F_a}{F_r} \leq e$		$\frac{F_a}{F_r} > e$	
X	Y	X	Y
1	0	0.4	Y_2

Static equivalent radial load

$$P_{0r} = 0.5 F_r + Y_0 F_a$$

When $P_{0r} < F_r$ use $P_{0r} = F_r$.

For values of e , Y_2 and Y_0 see the table below.

Bearing number ¹⁾	Installation-related dimensions						Load center mm	Constant e	Axial load factors		Mass kg (approx.)
	mm								Y_2	Y_0	
4T-1755/1729	29	27.5	49	51	1.3	1.3	6.5	0.31	1.95	1.07	0.252
4T-1280/1220	29.5	29	49	52	0.8	1.5	7.1	0.35	1.73	0.95	0.287
4T-LM72849/LM72810	30	28	40.5	44	1.5	1	3.0	0.47	1.27	0.70	0.125
4T-07093/07196	30.5	28.5	44.5	47	1.5	1	3	0.40	1.49	0.82	0.121
4T-L44640/L44610	30.5	28.5	44.5	47	1.5	1.3	3.4	0.37	1.60	0.88	0.133
4T-1779/1729	29.5	28.5	49	51	0.8	1.3	6.5	0.31	1.95	1.07	0.244
4T-07098/07196	31	29	44.5	47	1.5	1	3.0	0.40	1.49	0.82	0.121
4T-07097/07196	31	29	44.5	47	1.5	1	3.0	0.40	1.49	0.82	0.116
4T-07096/07196	31.5	29.5	44.5	47	1.5	1	3.0	0.40	1.49	0.82	0.12
4T-07100/07196	30.5	29.5	44.5	47	1	1	3.0	0.40	1.49	0.82	0.114
4T-07100S/07196	31.5	29.5	44.5	47	1.5	1	3.0	0.40	1.49	0.82	0.114
4T-L44643/L44610	32	30	44.5	47	1.3	1.3	3.4	0.37	1.60	0.88	0.13
4T-07100/07204	30.5	29.5	45	48	1	1.3	3.0	0.40	1.49	0.82	0.141
4T-1780/1729	30.5	30	49	51	0.8	1.3	6.5	0.31	1.95	1.07	0.234
4T-M84548/M84510	38.5	33	48.5	54	1.5	1.5	3.4	0.55	1.10	0.60	0.244
4T-15101/15243	32.5	31.5	54	58	0.8	2	6.0	0.35	1.71	0.94	0.301
4T-15100/15245	38	31.5	55	58	3.5	1.3	6.0	0.35	1.71	0.94	0.301
4T-15102/15245	34	31.5	55	58	1.5	1.3	6.0	0.35	1.71	0.94	0.303
4T-M86643/M86610	38	36.5	54	60	1.5	1.5	3.3	0.55	1.10	0.60	0.372
4T-23100/23256	39	34.5	53	63	1.5	1.5	2.0	0.73	0.82	0.45	0.363
4T-2687/2631	33.5	31.5	58	60	1.3	1.3	9.3	0.25	2.36	1.30	0.444
4T-15103/15245	33	32.5	55	58	0.8	1.3	6.0	0.35	1.71	0.94	0.3
4T-2682/2631	34.5	32	58	60	1.5	1.3	9.3	0.25	2.36	1.30	0.436
4T-L44649†/L44610	37.5	31	44.5	47	3.5	1.3	3.4	0.37	1.60	0.88	0.12
4T-15580†/15523	38.5	32	51	54	3.5	1.5	5.0	0.35	1.73	0.95	0.261
4T-15106†/15245	33.5	33	55	58	0.8	1.3	6.0	0.35	1.71	0.94	0.291
4T-2688†/2631	35	33	58	60	1.5	1.3	9.3	0.25	2.36	1.30	0.429
4T-1985/1930	34	33.5	51	54	0.8	0.8	5.9	0.33	1.82	1.00	0.217
4T-15590/15520	39.5	33.5	51	53	3.5	1.5	5.0	0.35	1.73	0.95	0.197

1) As for the maximum value for inner ring bore diameters of bearings whose bearing numbers are marked with "†" (inner ring), the precision class is an integer for class 4 and class 2 bearings only.

Inch series
J series

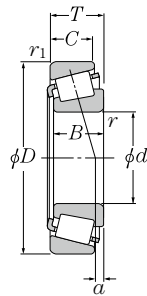

a 28.575 ~ 31.750mm

	Boundary dimensions				Basic load rating		Allowable speed	
	mm				dynamic C _r kN	static C _{0r}	Grease lubrication min ⁻¹	Oil lubrication
	d	D	T	B				
28.575	58.738	19.050	19.355	15.080	45.0	44.5	6 700	8 900
	60.325	19.842	17.462	15.875	44.0	45.5	6 700	8 900
	60.325	19.845	19.355	15.875	45.0	44.5	6 700	8 900
	62.000	19.050	20.638	14.288	52.0	54.0	6 100	8 200
	64.292	21.433	21.433	16.670	57.5	64.5	6 100	8 100
	66.421	23.812	25.433	19.050	71.5	72.5	6 200	8 200
	68.262	22.225	22.225	17.462	63.0	67.0	5 800	7 700
	68.262	22.225	23.812	17.462	64.0	65.5	5 700	7 700
	69.850	23.812	25.357	19.050	76.5	81.5	5 700	7 600
	72.626	24.608	24.257	17.462	64.5	55.5	5 800	7 700
73.025	22.225	22.225	17.462	62.5	68.0	5 300	7 000	
29.000	50.292	14.224	14.732	10.668	31.0	35.5	7 200	9 600
29.367	66.421	23.812	25.433	19.050	71.5	72.5	6 200	8 200
29.987	62.000	16.002	16.566	14.288	43.0	42.0	6 300	8 400
	62.000	19.050	20.638	14.288	52.0	54.0	6 100	8 200
30.000	69.012	19.845	19.583	15.875	53.5	58.0	5 600	7 400
	72.000	29.370	27.783	23.020	80.0	97.0	5 400	7 100
30.112	62.000	19.050	20.638	14.288	52.0	54.0	6 100	8 200
30.162	62.000	16.002	16.566	14.288	43.0	42.0	6 300	8 400
	64.292	21.433	21.433	16.670	57.5	64.5	6 100	8 100
	69.850	23.812	25.357	19.050	76.5	81.5	5 700	7 600
	72.626	30.162	29.997	23.812	93.5	98.0	5 500	7 300
30.213	62.000	19.050	20.638	14.288	52.0	54.0	6 100	8 200
	62.000	19.050	20.638	14.288	52.0	54.0	6 100	8 200
	62.000	19.050	20.638	14.288	52.0	54.0	6 100	8 200
30.226	69.012	19.845	19.583	15.875	53.5	58.0	5 600	7 400
	69.012	19.845	19.583	15.875	53.5	58.0	5 600	7 400
31.750	59.131	15.875	16.764	11.811	38.5	41.0	6 300	8 400
	62.000	18.161	19.050	14.288	52.0	54.0	6 100	8 200
	62.000	19.050	20.638	14.288	52.0	54.0	6 100	8 200

Note: Chamfer dimensions on the back face of the inner and outer rings of the bearing are larger than the maximum values of installation-related dimensions r_{1a} and r_{1as} .
1) As for the maximum value for inner ring bore diameters of bearings whose bearing numbers are marked with "T" (inner ring), the precision class is an integer for class 4 and class 2 bearings only.

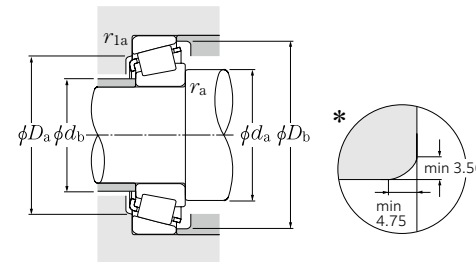

Dynamic equivalent radial load

$$P_r = X F_r + Y F_a$$

$\frac{F_a}{F_r} \leq e$		$\frac{F_a}{F_r} > e$	
X	Y	X	Y
1	0	0.4	Y_2

Static equivalent radial load

$$P_{0r} = 0.5 F_r + Y_0 F_a$$

When $P_{0r} < F_r$ use $P_{0r} = F_r$.

For values of e ,

Y_2 and Y_0 see the table below.

Bearing number ^{1) 2)}	Installation-related dimensions						Load center mm	Constant e	Axial load factors		Mass kg (approx.)		
	mm								a	e		Y_2	Y_0
	d_a	d_b	D_a	D_b	$r_{as}^{3)}$ Max.	r_{1as} Max.							
4T-1985/1932	34	33.5	52	54	0.8	1.3	5.9	0.33	1.82	1.00	0.231		
4T-15590/15523	39.5	33.5	51	54	3.5	1.5	5.0	0.35	1.73	0.95	0.25		
4T-1985/1931	34	33.5	52	55	0.8	1.3	5.9	0.33	1.82	1.00	0.256		
4T-15112/15245	40	34	55	58	3.5	1.3	6.0	0.35	1.71	0.94	0.279		
4T-M86647/M86610	40	31	54	60	1.5	1.5	3.3	0.55	1.10	0.60	0.348		
4T-2689/2631	37.5	36	58	60	1.3	1.3	9.3	0.25	2.36	1.30	0.363		
4T-02474/02420	36.5	36	59	63	0.8	1.5	5.2	0.42	1.44	0.79	0.41		
4T-2474/2420	36	35	60	63	0.8	1.5	6.5	0.34	1.77	0.97	0.38		
4T-2578/2523	39	35	61	64	2.3	1.3	9.1	0.27	2.19	1.21	0.484		
4T-41125/41286	48	36.5	61	68	4.8	1.5	3.7	0.60	1.00	0.55	0.475		
4T-02872/02820	37.5	37	62	68	0.8	3.3	3.9	0.45	1.32	0.73	0.481		
4T-L45449/L45410	40	33.5	44.5	48	3.5	1.3	3.5	0.37	1.62	0.89	0.113		
4T-2690/2631	41	35	58	60	3.5	1.3	9.3	0.25	2.36	1.30	0.407		
4T-17118†/17244	38.5	36	54	57	1.5	1.5	3.3	0.38	1.57	0.86	0.229		
4T-15117†/15245	36.5	35	55	58	1.3	1.3	6.0	0.35	1.71	0.94	0.27		
4T-14117A/14276	44	41	60	63	3.5	1.3	4.1	0.38	1.57	0.86	0.37		
#4T-JHM88540/JHM88513	44.5	42.5	58	69	1.3	3.3	6.0	0.55	1.10	0.60	0.62		
4T-15116/15245	36	35.5	55	58	0.8	1.3	6.0	0.35	1.71	0.94	0.27		
4T-17119/17244	37	34.5	54	57	1.5	1.5	3.3	0.38	1.57	0.86	0.228		
4T-M86649/M86610	44	38	54	60	1.5	1.5	3.3	0.55	1.10	0.60	0.336		
4T-2558/2523	40	36.5	61	64	2.3	1.3	9.1	0.27	2.19	1.21	0.467		
4T-3187/3120	39	38.5	61	67	0.8	3.3	9.9	0.33	1.80	0.99	0.621		
4T-15118/15245	43	36.5	55	58	3.5	1.3	6.0	0.35	1.71	0.94	0.266		
4T-15119/15245	37.5	35.5	55	58	1.5	1.3	6.0	0.35	1.71	0.94	0.269		
4T-15120/15245	36	35.5	55	58	0.8	1.3	6.0	0.35	1.71	0.94	0.269		
4T-14116/14274	38.5	38	59	63	0.8	3.3	4.1	0.38	1.57	0.86	0.369		
4T-14116/14276	38.5	38	60	63	0.8	1.3	4.1	0.38	1.57	0.86	0.371		
4T-LM67048/LM67010	42.5	36	52	56	*	1.3	2.8	0.41	1.46	0.80	0.183		
4T-15123/15245	44	38	55	58	*	1.3	5.1	0.35	1.71	0.94	0.249		
4T-15125/15245	42.5	36.5	55	58	3.5	1.3	6.0	0.35	1.71	0.94	0.254		

2) Bearing numbers marked with "#" designate J-series bearings. The tolerance of these bearings is listed in Table 6.8 on page A-66 to A-67.
3) Chamfer dimensions of the bearings marked with "*" are shown in the above drawings.

Tapered Roller Bearings



Inch series
J series

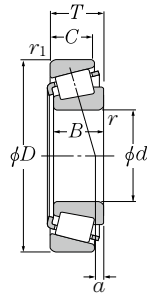

d 31.750 ~ 34.925mm

	Boundary dimensions					Basic load rating		Allowable speed	
	mm					dynamic C _r kN	static C _{0r}	Grease lubrication	Oil lubrication
	d	D	T	B	C				
31.750	62.000	19.050	20.638	14.288	52.0	54.0	6 100	8 200	
	66.421	25.400	25.357	20.638	76.5	81.5	5 700	7 600	
	68.262	22.225	22.225	17.462	63.0	67.0	5 800	7 700	
	68.262	22.225	22.225	17.462	63.0	67.0	5 800	7 700	
	69.012	19.845	19.583	15.875	53.5	58.0	5 600	7 400	
	69.012	19.845	19.583	15.875	53.5	58.0	5 600	7 400	
	69.850	23.812	25.357	19.050	76.5	81.5	5 700	7 600	
	69.850	23.812	25.357	19.050	76.5	81.5	5 700	7 600	
	72.626	30.162	29.997	23.812	93.5	98.0	5 500	7 300	
	72.626	30.162	29.997	23.812	93.5	98.0	5 500	7 300	
	73.025	22.225	22.225	17.462	62.5	68.0	5 300	7 000	
	73.025	22.225	23.812	17.462	69.5	75.5	5 200	7 000	
	73.025	29.370	27.783	23.020	80.0	97.0	5 400	7 100	
	73.812	29.370	27.783	23.020	80.0	97.0	5 400	7 100	
76.200	29.370	28.575	23.020	86.5	105	5 100	6 800		
79.375	29.370	29.771	23.812	103	114	4 900	6 600		
33.338	68.262	22.225	22.225	17.462	62.5	71.0	5 700	7 500	
	69.012	19.845	19.583	15.875	53.5	58.0	5 600	7 400	
	69.850	23.812	25.357	19.050	76.5	81.5	5 700	7 600	
	72.626	30.162	29.997	23.812	93.5	98.0	5 500	7 300	
	73.025	29.370	27.783	23.020	80.0	97.0	5 400	7 100	
	76.200	23.812	25.654	19.050	81.0	90.5	5 100	6 800	
	76.200	29.370	28.575	23.020	86.5	105	5 100	6 800	
	76.200	29.370	28.575	23.020	86.5	105	5 100	6 800	
	79.375	25.400	24.074	17.462	72.5	67.0	5 200	6 900	
34.925	65.088	18.034	18.288	13.970	51.5	56.0	5 700	7 600	
	65.088	18.034	18.288	13.970	51.5	56.0	5 700	7 600	
	69.012	19.845	19.583	15.875	53.5	58.0	5 600	7 400	
	72.233	25.400	25.400	19.842	72.0	84.5	5 400	7 200	
	72.238	20.638	20.638	15.875	53.0	58.5	5 300	7 000	
	73.025	22.225	22.225	17.462	62.5	68.0	5 300	7 000	
	73.025	22.225	22.225	17.462	62.5	68.0	5 300	7 000	
	73.025	22.225	23.812	17.462	69.5	75.5	5 200	7 000	
	73.025	23.812	24.608	19.050	78.5	85.0	5 300	7 100	
	73.025	23.812	24.608	19.050	78.5	85.0	5 300	7 100	
	73.025	23.812	25.654	19.050	81.0	90.5	5 100	6 800	
	76.200	23.812	25.654	19.050	81.0	90.5	5 100	6 800	

Note: Chamfer dimensions on the back face of the inner and outer rings of the bearing are larger than the maximum values of installation-related dimensions r_{as} and r_{1as} .

Tapered Roller Bearings

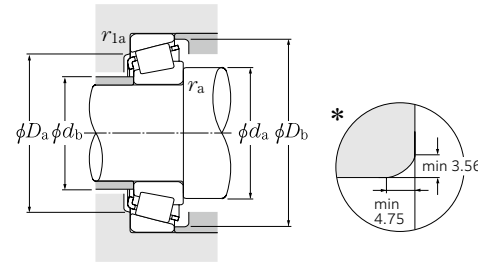

Dynamic equivalent radial load

$$P_r = X F_r + Y F_a$$

$\frac{F_a}{F_r} \leq e$		$\frac{F_a}{F_r} > e$	
X	Y	X	Y
1	0	0.4	Y_2

Static equivalent radial load

$$P_{0r} = 0.5 F_r + Y_0 F_a$$

When $P_{0r} < F_r$ use $P_{0r} = F_r$.

For values of e ,

Y_2 and Y_0 see the table below.

Bearing number ¹⁾	Installation-related dimensions						Load center mm	Constant mm	Axial load factors		Mass kg (approx.)		
	mm								a	e		Y ₂	Y ₀
	d _a	d _b	D _a	D _b	r _{as} ¹⁾ Max.	r _{1as} Max.							
4T-15126/15245	38.5	38	55	58	0.8	1.3	6.0	0.35	1.71	0.94	0.257		
4T-2580/2520	38.5	37.5	56.9	62.5	0.8	3.3	9.1	0.27	2.19	1.21	0.41		
4T-02475/02420	44.5	38.5	59	63	3.5	1.5	5.2	0.42	1.44	0.79	0.382		
4T-02476/02420	39	38.5	59	63	0.8	1.5	5.2	0.42	1.44	0.79	0.384		
4T-14124/14276	39.5	39	60	63	0.8	1.3	4.1	0.38	1.57	0.86	0.36		
4T-14125A/14276	45	39	60	63	3.5	1.3	4.1	0.38	1.57	0.86	0.357		
4T-2580/2523	38.5	37.5	61	64	0.8	1.3	9.1	0.27	2.19	1.21	0.455		
4T-2582/2523	44	37.5	61	64	3.5	1.3	9.1	0.27	2.19	1.21	0.452		
4T-3188/3120	40	39.5	61	67	0.8	3.3	9.9	0.33	1.80	0.99	0.606		
4T-3193/3120	45.5	39.5	61	67	3.5	3.3	9.9	0.33	1.80	0.99	0.605		
4T-02875/02820	45.5	39.5	62	68	3.5	3.3	3.9	0.45	1.32	0.73	0.453		
4T-2879/2820	39.5	38.5	63	68	0.8	3.3	5.5	0.37	1.63	0.90	0.466		
4T-HM88542/HM88510	45.5	42.6	59	70	1.3	3.3	6.0	0.55	1.10	0.60	0.622		
4T-HM88542/HM88512	45.5	42.6	60	70	1.3	3.3	6.0	0.55	1.10	0.60	0.638		
4T-HM89440/HM89410	45.5	44.3	62	73	0.8	3.3	5.8	0.55	1.10	0.60	0.686		
4T-3476/3420	43	41	67	74	1.3	3.3	8.7	0.37	1.64	0.90	0.772		
4T-M88048/M88010	42.5	41.2	58	65	0.8	1.5	2.9	0.55	1.10	0.60	0.379		
4T-14130/14276	46.5	40	60	63	3.5	1.3	4.1	0.38	1.57	0.86	0.345		
4T-2585/2523	45	39	61	64	3.5	1.3	9.1	0.27	2.19	1.21	0.436		
4T-3196/3120	47	40.5	61	67	3.5	3.3	9.9	0.33	1.80	0.99	0.584		
4T-HM88547/HM88510	45.5	42.6	59	70	0.8	3.3	6.0	0.55	1.10	0.60	0.603		
4T-2785/2720	46	40	66	70	3.5	3.3	7.8	0.30	1.98	1.09	0.548		
4T-HM89443/HM89410	46.5	44.3	62	73	0.8	3.3	5.8	0.55	1.10	0.60	0.667		
4T-HM89444/HM89410	53	44.3	62	73	3.8	3.3	5.8	0.55	1.10	0.60	0.665		
4T-43131/43312	51	42.1	67	74	3.5	1.5	1.4	0.67	0.90	0.49	0.568		
4T-LM48548/LM48510	48	41.5	58	61	*	1.3	3.7	0.38	1.59	0.88	0.25		
4T-LM48548A/LM48510	40.5	42.2	58	61	0.8	1.3	3.7	0.38	1.59	0.88	0.252		
4T-14137A/14276	43.5	41.5	60	63	1.5	1.3	4.1	0.38	1.57	0.86	0.334		
4T-HM88649/HM88610	48.5	42.5	60	69	2.3	2.3	4.6	0.55	1.10	0.60	0.489		
4T-16137/16284	47	40.5	63	67	3.5	1.3	4.2	0.40	1.49	0.82	0.37		
4T-02877/02820	48.5	42	62	68	3.5	3.3	3.9	0.45	1.32	0.73	0.423		
4T-02878/02820	42.5	42	62	68	0.8	3.3	3.9	0.45	1.32	0.73	0.426		
4T-2878/2820	42	41	63	68	0.8	3.3	5.5	0.37	1.63	0.90	0.435		
4T-25877/25820	43	40.5	64	68	1.5	2.3	8.1	0.29	2.07	1.14	0.47		
4T-25877/25821	43	40.5	65	68	1.5	0.8	8.1	0.29	2.07	1.14	0.473		
4T-2793/2735X	42	41	66	69	0.8	0.8	7.8	0.30	1.98	1.09	0.444		
4T-2793/2720	42	41	66	70	0.8	3.3	7.8	0.30	1.98	1.09	0.534		

1) Chamfer dimensions of the bearings marked "*" are shown in the above drawings.

Tapered Roller Bearings



Inch series
J series

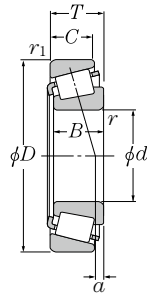

d 34.925 ~ 38.100mm

d	Boundary dimensions				Basic load rating		Allowable speed	
	mm				dynamic C _r kN	static C _{0r}	Grease lubrication min ⁻¹	Oil lubrication
	D	T	B	C				
34.925	76.200	23.812	25.654	19.050	81.0	90.5	5 100	6 800
	76.200	29.370	28.575	23.020	86.5	105	5 100	6 800
	76.200	29.370	28.575	23.812	89.5	97.0	5 100	6 800
	76.200	29.370	28.575	23.812	89.5	97.0	5 100	6 800
	79.375	29.370	29.771	23.812	103	114	4 900	6 600
	80.167	29.370	30.391	23.812	105	112	4 800	6 400
85.725	30.162	30.162	23.812	116	132	4 500	6 000	
34.976	69.012	19.845	19.583	15.875	53.5	58.0	5 600	7 400
34.988	59.974	15.875	16.764	11.938	39.0	47.5	6 100	8 100
	61.973	16.700	17.000	13.600	41.0	48.0	5 900	7 900
	61.973	18.000	17.000	15.000	41.0	48.0	5 900	7 900
35.000	70.000	24.000	23.500	19.000	69.0	78.0	5 500	7 300
	79.375	23.812	25.400	19.050	85.0	97.5	4 800	6 400
	80.000	21.000	22.403	17.826	75.5	75.0	4 700	6 300
35.717	72.233	25.400	25.400	19.842	72.0	84.5	5 400	7 200
	72.626	25.400	25.400	19.842	72.0	84.5	5 400	7 200
36.487	73.025	23.812	24.608	19.050	78.5	85.0	5 300	7 100
	76.200	23.812	25.654	19.050	81.0	90.5	5 100	6 800
36.512	76.200	29.370	28.575	23.020	86.5	105	5 100	6 800
	76.200	29.370	28.575	23.020	86.5	105	5 100	6 800
	76.200	29.370	28.575	23.812	89.5	97.0	5 100	6 800
	79.375	29.370	28.829	22.664	95.5	104	5 000	6 600
	79.375	29.370	29.771	23.812	103	114	4 900	6 600
	88.500	25.400	23.698	17.462	78.5	78.0	4 000	5 300
38.000	63.000	17.000	17.000	13.500	43.0	52.5	5 700	7 600
38.100	63.500	12.700	11.908	9.525	28.7	33.5	5 500	7 300
	65.088	18.034	18.288	13.970	48.0	57.0	5 500	7 400
	69.012	19.050	19.050	15.083	53.0	59.5	5 300	7 100
	69.012	19.050	19.050	15.083	53.0	59.5	5 300	7 100
	71.438	15.875	16.520	11.908	48.0	51.0	5 400	7 200
	72.000	19.000	20.638	14.237	53.0	58.5	5 300	7 000

Note: Chamfer dimensions on the back face of the inner and outer rings of the bearing are larger than the maximum values of installation-related dimensions r_{1a} and r_{1as} .
1) As for the maximum value for inner and outer ring diameters of bearings whose bearing numbers are marked with "†" (inner ring) and "††" (outer ring), the precision class is an integer for class 4 and class 2 bearings only. B-162

Tapered Roller Bearings

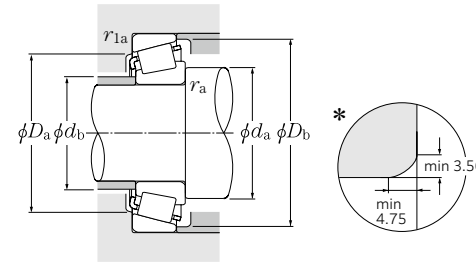

Dynamic equivalent radial load

$$P_r = X F_r + Y F_a$$

$\frac{F_a}{F_r} \leq e$		$\frac{F_a}{F_r} > e$	
X	Y	X	Y
1	0	0.4	Y_2

Static equivalent radial load

$$P_{0r} = 0.5 F_r + Y_0 F_a$$

When $P_{0r} < F_r$ use $P_{0r} = F_r$.

For values of e ,
 Y_2 and Y_0 see the table below.

Bearing number 1) 2)	Installation-related dimensions						Load center ⁴⁾ mm	Constant e	Axial load factors		Mass kg (approx.)	
	mm								a	Y ₂		Y ₀
	d _a	d _b	D _a	D _b	r _{as} ³⁾ Max.	r _{1as} Max.						
4T-2796/2729	47.5	41	68	70	3.5	0.8	7.8	0.30	1.98	1.09	0.536	
4T-HM89446/HM89410	56	44.3	62	73	3.5	3.3	5.8	0.55	1.10	0.60	0.646	
4T-31593/31520	50	43.5	64	72	3.5	3.3	7.8	0.40	1.49	0.82	0.626	
4T-31594/31520	46	43.5	64	72	1.5	3.3	7.8	0.40	1.49	0.82	0.628	
4T-3478/3420	50	43.5	67	74	3.5	3.3	8.7	0.37	1.64	0.90	0.731	
4T-3379/3320	48	41.5	70	75	3.5	3.3	11.2	0.27	2.20	1.21	0.736	
4T-3872/3820	53	46	73	81	3.5	3.3	8.1	0.40	1.49	0.82	0.902	
4T-14139/14276	43.5	41.5	60	63	1.3	1.3	4.1	0.38	1.57	0.86	0.33	
4T-L68149†/L68111††	45.5	39	53	56	*	1.3	2.5	0.42	1.44	0.79	0.179	
4T-LM78349A†/LM78310A††	42	39.5	54	59	1.5	1.5	2.4	0.44	1.35	0.74	0.206	
4T-LM78349†/LM78310C††	46	40	56	59	*	1.5	2.4	0.44	1.35	0.74	0.218	
#4T-JS3549A/JS3510	47	42	60	66.5	2	1.5	3.6	0.55	1.10	0.60	0.42	
4T-26883/26822	42.5	42	71	74	0.8	0.8	7.4	0.32	1.88	1.04	0.61	
4T-339/332	42.5	41.5	73	75	0.8	1.3	6.6	0.27	2.20	1.21	0.534	
4T-HM88648/HM88610	54	42.5	60	69	3.5	2.3	4.6	0.55	1.10	0.60	0.477	
4T-HM88648/HM88611AS	54	42.5	59	69	3.5	3.3	3.0	0.55	1.10	0.60	0.482	
4T-25880/25821	44	42	65	68	1.5	0.8	8.1	0.29	2.07	1.14	0.456	
4T-2780/2720	44.5	42.5	66	70	1.5	3.3	7.8	0.30	1.98	1.09	0.516	
4T-HM89448/HM89410	48.5	44.3	62	73	0.8	3.3	5.8	0.55	1.10	0.60	0.628	
4T-HM89449/HM89411	57	44.3	65	73	3.5	0.8	5.8	0.55	1.10	0.60	0.63	
4T-31597/31520	51	44.5	64	72	3.5	3.3	7.8	0.40	1.49	0.82	0.606	
4T-HM89249/HM89210	55	44	66	75	3.5	3.3	5.8	0.55	1.10	0.60	0.689	
4T-3479/3420	45.5	44.5	67	74	0.8	3.3	8.7	0.37	1.64	0.90	0.707	
4T-44143/44348	54	50	75	84	2.3	1.5	-2.9	0.78	0.77	0.42	0.73	
#4T-JL69349/JL69310	46.5	42.5	56	60	*	1.3	2.3	0.42	1.44	0.79	0.2	
4T-13889/13830	45	42.5	59	60	1.5	0.8	0.8	0.35	1.73	0.95	0.148	
4T-LM29748/LM29710	49	42.5	58.9	62	*	1.3	4.3	0.33	1.80	0.99	0.227	
4T-13685/13621	49.5	43	61	65	3.5	2.3	3.0	0.40	1.49	0.82	0.294	
4T-13687/13621	46.5	43	61	65	2	2.3	3.0	0.40	1.49	0.82	0.296	
4T-19150/19281	45	43	63	66	1.5	1.5	1.4	0.44	1.35	0.74	0.241	
4T-16150/16282	49.5	43	63	67	3.5	1.5	4.2	0.40	1.49	0.82	0.331	

2) Bearing numbers marked with "#" designate J-series bearings. The tolerance of these bearings is listed in Table 6.8 on page A-66 to A-67.
3) Chamfer dimensions of the bearings marked with "*" are shown in the above drawings. 4) Dimensions with "-" indicate a load center at the outside on the end of an inner ring. B-163

Inch series

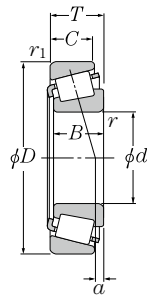

d 38.100 ~ 41.275mm

d	Boundary dimensions				Basic load rating		Allowable speed	
	mm				dynamic C _r kN	static C _{0r}	Grease lubrication min ⁻¹	Oil lubrication
	D	T	B	C				
38.100	76.200	20.638	20.940	15.507	61.5	63.0	5 000	6 700
	76.200	23.812	25.654	19.050	81.0	90.5	5 100	6 800
	76.200	23.812	25.654	19.050	81.0	90.5	5 100	6 800
	79.375	23.812	25.400	19.050	85.0	97.5	4 800	6 400
	79.375	29.370	29.771	23.812	103	114	4 900	6 600
	80.000	21.006	20.940	15.875	61.5	63.0	5 000	6 700
	80.035	24.608	23.698	18.512	74.5	82.5	4 800	6 400
	82.550	29.370	28.575	23.020	96.5	117	4 700	6 200
	82.931	23.812	25.400	19.050	84.5	98.0	4 500	6 000
	85.725	30.162	30.162	23.812	116	132	4 500	6 000
87.312	30.162	30.886	23.812	104	117	4 400	5 900	
88.500	25.400	23.698	17.462	78.5	78.0	4 000	5 300	
88.500	26.988	29.083	22.225	106	107	4 600	6 100	
39.688	76.200	23.812	25.654	19.050	81.0	90.5	5 100	6 800
	77.534	29.370	30.391	23.812	105	112	4 800	6 400
	79.375	23.812	25.400	19.050	85.0	97.5	4 800	6 400
	80.035	29.370	30.391	23.812	105	112	4 800	6 400
	80.167	29.370	30.391	23.812	105	112	4 800	6 400
	88.500	25.400	23.698	17.462	78.5	78.0	4 000	5 300
40.000	76.200	20.638	20.940	15.507	61.5	63.0	5 000	6 700
	80.000	21.000	22.403	17.826	75.5	75.0	4 700	6 300
	85.000	20.638	21.692	17.462	77.5	79.5	4 400	5 800
	88.500	26.988	29.083	22.225	106	107	4 600	6 100
	107.950	36.512	36.957	28.575	157	177	3 600	4 800
40.483	82.550	29.370	28.575	23.020	96.5	117	4 700	6 200
40.988	67.975	17.500	18.000	13.500	51.0	62.5	5 300	7 000
41.275	73.025	16.667	17.462	12.700	51.0	55.5	5 000	6 600
	73.431	19.558	19.812	14.732	62.0	69.5	5 000	6 600
	73.431	21.430	19.812	16.604	62.0	69.5	5 000	6 600
	76.200	18.009	17.384	14.288	47.0	51.5	4 900	6 500
	76.200	22.225	23.020	17.462	72.0	80.5	4 900	6 500
	76.200	25.400	25.400	20.638	85.0	97.5	4 800	6 400
	79.378	23.812	25.400	19.050	85.0	97.5	4 800	6 400
	80.000	18.009	17.384	14.288	47.0	51.5	4 900	6 500

Note: Chamfer dimensions on the back face of the inner and outer rings of the bearing are larger than the maximum values of installation-related dimensions r_{1a} and r_{1as} .
 1) As for the maximum value for inner and outer ring diameters of bearings whose bearing numbers are marked with "†" (inner ring) and "††" (outer ring), the precision class is an integer for class 4 and class 2 bearings only.
 B-164

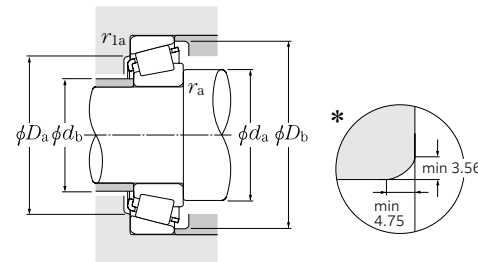

Dynamic equivalent radial load

$$P_r = X F_r + Y F_a$$

$\frac{F_a}{F_r} \leq e$		$\frac{F_a}{F_r} > e$	
X	Y	X	Y
1	0	0.4	Y_2

Static equivalent radial load

$$P_{0r} = 0.5 F_r + Y_0 F_a$$

When $P_{0r} < F_r$ use $P_{0r} = F_r$.

For values of e ,

Y_2 and Y_0 see the table below.

Bearing number ¹⁾	Installation-related dimensions						Load center ³⁾ mm	Constant e	Axial load factors		Mass kg (approx.)		
	mm								a	e		Y ₂	Y ₀
	d _a	d _b	D _a	D _b	r _{as} ²⁾ Max.	r _{1as} Max.							
4T-28150/28300	45.5	43.5	68	71	1.5	1.3	4.8	0.40	1.49	0.82	0.406		
4T-2776/2720	52	43.5	66	70	4.3	0.8	7.8	0.30	1.98	1.09	0.495		
4T-2788/2720	50	43.5	66	70	3.5	3.3	7.8	0.30	1.98	1.09	0.494		
4T-26878/26822	45	44.5	71	74	0.8	0.8	7.4	0.32	1.88	1.04	0.575		
4T-3490/3420	52	45.5	67	74	3.5	3.3	8.7	0.37	1.64	0.90	0.688		
4T-28150/28315	45.5	43.5	69	73	1.5	1.5	4.8	0.40	1.49	0.82	0.467		
4T-27880/27820	48	47	68	75	0.8	1.5	2.5	0.56	1.07	0.59	0.567		
4T-HM801346/HM801310	51	49.1	68	78	0.8	3.3	4.7	0.55	1.10	0.60	0.767		
4T-25572/25520	46	46	74	77	0.8	0.8	6.2	0.33	1.79	0.99	0.646		
4T-3875/3820	49.5	48.5	73	81	0.8	3.3	8.1	0.40	1.49	0.82	0.861		
4T-3580/3525	48	45.5	75	81	1.5	3.3	10.0	0.31	1.96	1.08	0.881		
4T-44150/44348	55	50.8	75	84	2.3	1.5	-2.9	0.78	0.77	0.42	0.714		
4T-418/414	51	44.5	77	80	3.5	1.5	9.1	0.26	2.28	1.25	0.843		
4T-2789/2720	52	45	66	70	3.5	3.3	7.8	0.30	1.98	1.09	0.475		
4T-3382/3321	52	45.5	68	75	3.5	3.3	11.2	0.27	2.20	1.21	0.669		
4T-26880/26822	48	45.5	71	74	1.5	0.8	7.4	0.32	1.88	1.04	0.556		
4T-3382/3339	52	45.5	71	74.8	3.5	1.5	11.2	0.27	2.20	1.21	0.666		
4T-3386/3320	46.5	45.5	70	75	0.8	3.3	11.2	0.27	2.20	1.21	0.672		
4T-44158/44348	58	50.8	75	84	3.5	1.5	-2.9	0.78	0.77	0.42	0.691		
4T-28158/28300	47.5	45	68	71	1.5	1.3	4.8	0.40	1.49	0.82	0.387		
4T-344/332	52	45.5	73	75	3.5	1.3	6.6	0.27	2.20	1.21	0.479		
4T-350A/354A	47.5	46.5	77	80	0.8	1.3	5.1	0.31	1.96	1.08	0.566		
4T-420/414	52	46	77	80	3.5	1.5	9.1	0.26	2.28	1.25	0.817		
4T-543/532X	57	50	94	100	3.5	3.3	12.3	0.30	2.02	1.11	1.77		
4T-HM801349/HM801310	58	49.1	68	78	3.5	3.3	4.7	0.55	1.10	0.60	0.734		
4T-LM300849†/LM300811††	52	45.5	61	65	*	1.5	3.6	0.35	1.72	0.95	0.232		
4T-18590/18520	53	46	66	69	3.5	1.5	2.9	0.35	1.71	0.94	0.283		
4T-LM501349/LM501310	54	48	67	70	3.5	0.8	3.3	0.40	1.50	0.83	0.334		
4T-LM501349/LM501314	54	48	65	70	3.5	0.8	3.3	0.40	1.50	0.83	0.354		
4T-11162/11300	49	46.5	67	71	1.5	1.5	0.7	0.49	1.23	0.68	0.337		
4T-24780/24720	54	47	68	72	3.5	0.8	4.5	0.39	1.53	0.84	0.435		
4T-26882/26823	54	47	69	73	3.5	1.5	7.4	0.32	1.88	1.04	0.49		
4T-26885/26822	48	47	71	74	0.8	0.8	7.4	0.32	1.88	1.04	0.535		
4T-11162/11315	49	46.5	69	73	1.5	1.5	0.7	0.49	1.23	0.68	0.389		

2) Chamfer dimensions of the bearings marked "*" are shown in the above drawings.
 3) Dimensions with "-" indicate a load center at the outside on the end of an inner ring.
 B-165

Inch series

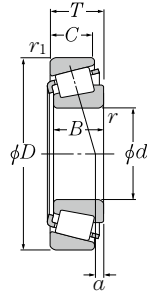

d 41.275 ~ 44.450mm

d	Boundary dimensions				Basic load rating		Allowable speed	
	mm				dynamic C _r	static C _{0r}	min ⁻¹	
	D	T	B	C			Grease lubrication	Oil lubrication
41.275	80.000	21.000	22.403	17.826	75.5	75.0	4 700	6 300
	79.378	23.812	25.400	19.050	85.0	97.5	4 800	6 400
	82.550	26.543	25.654	20.193	89.0	104	4 600	6 100
	85.725	30.162	30.162	23.812	116	132	4 500	6 000
	87.312	30.162	30.886	23.812	104	117	4 400	5 900
	88.900	30.162	29.370	23.020	104	125	4 300	5 800
	90.488	39.688	40.386	33.338	151	175	4 300	5 800
	92.075	26.195	23.812	16.670	80.5	81.5	3 800	5 000
	93.662	31.750	31.750	26.195	115	131	4 100	5 500
	95.250	30.162	29.370	23.020	120	147	4 000	5 300
95.250	30.958	28.300	20.638	91.5	92.0	3 700	5 000	
95.250	30.958	28.575	22.225	107	116	3 700	4 900	
42.070	90.488	39.688	40.386	33.338	151	175	4 300	5 800
42.862	82.550	26.195	26.988	20.638	83.5	97.0	4 600	6 100
	82.931	23.812	25.400	19.050	84.5	98.0	4 500	6 000
	87.312	30.162	30.886	23.812	104	117	4 400	5 900
42.875	79.375	23.812	25.400	19.050	85.0	97.5	4 800	6 400
	82.931	23.812	25.400	19.050	84.5	98.0	4 500	6 000
44.450	76.992	17.462	17.145	11.908	48.5	54.0	4 700	6 300
	79.375	17.462	17.462	13.495	50.5	56.0	4 600	6 200
	82.931	23.812	25.400	19.050	84.5	98.0	4 500	6 000
	82.931	23.812	25.400	19.050	84.5	98.0	4 500	6 000
	84.138	30.162	30.886	23.812	104	117	4 400	5 900
	85.000	20.638	21.692	17.462	77.5	79.5	4 400	5 800
	87.312	30.162	30.886	23.812	104	117	4 400	5 900
	88.900	30.162	29.370	23.020	104	125	4 300	5 800
	93.264	30.162	30.302	23.812	113	134	4 000	5 300
	93.662	31.750	31.750	26.195	115	131	4 100	5 500
	95.250	27.783	28.575	22.225	119	139	3 900	5 200
	95.250	27.783	29.900	22.225	120	129	4 200	5 600
	95.250	30.162	29.370	23.020	120	147	4 000	5 300
	95.250	30.958	28.300	20.638	91.5	92.0	3 700	5 000
95.250	30.958	28.575	22.225	107	116	3 700	4 900	
101.600	34.925	36.068	26.988	150	165	3 800	5 000	
104.775	30.162	29.317	24.605	127	148	3 500	4 700	

Note: Chamfer dimensions on the back face of the inner and outer rings of the bearing are larger than the maximum values of installation-related dimensions r_{as} and r_{1as} .

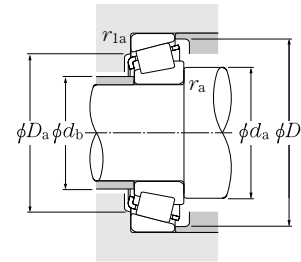

Dynamic equivalent radial load

$$P_r = X F_r + Y F_a$$

$\frac{F_a}{F_r} \leq e$		$\frac{F_a}{F_r} > e$	
X	Y	X	Y
1	0	0.4	Y ₂

Static equivalent radial load

$$P_{0r} = 0.5 F_r + Y_0 F_a$$

When $P_{0r} < F_r$ use $P_{0r} = F_r$.

For values of e , Y_2 and Y_0 see the table below.

Bearing number	Installation-related dimensions						Load center ¹⁾ mm	Constant e	Axial load factors		Mass kg (approx.)	
	mm								a	Y ₂		Y ₀
	d _a	d _b	D _a	D _b	r _{as} Max.	r _{1as} Max.						
4T-336/332	47	46	73	75	0.8	1.3	6.6	0.27	2.20	1.21	0.468	
4T-26882/26824	54	47	70	74	3.5	0.8	7.4	0.32	1.88	1.04	0.532	
4T-M802048/M802011	57	50.6	70	79	3.5	3.3	3.2	0.55	1.10	0.60	0.641	
4T-3880/3820	52	50	73	81	0.8	3.3	8.1	0.40	1.49	0.82	0.814	
4T-3576/3525	49	48	75	81	0.8	3.3	10.0	0.31	1.96	1.08	0.83	
4T-HM803145/HM803110	54	53	74	85	0.8	3.3	4.6	0.55	1.10	0.60	0.902	
4T-4388/4335	60	52	77	85	3.5	3.3	15.0	0.28	2.11	1.16	1.26	
4T-M903345/M903310	65	54	78	88	3.5	1.5	-3.6	0.83	0.72	0.40	0.758	
4T-46162/46368	52	51	79	87	0.8	3.3	7.1	0.40	1.49	0.82	1.09	
4T-HM804840/HM804810	61	54	81	91	3.5	3.3	3.7	0.55	1.10	0.60	1.08	
4T-53162/53375	57	52.7	81	89	1.5	0.8	0.5	0.74	0.81	0.45	0.974	
4T-HM903245/HM903210	63	54	81	91	3.5	0.8	-0.4	0.74	0.81	0.45	1.05	
4T-4395/4335	60	52	77	85	3.5	3.3	15.0	0.28	2.11	1.16	1.24	
4T-22780/22720	56	50	71	77	3.5	3.3	6.4	0.40	1.49	0.82	0.618	
4T-25578/25520	53	49.5	74	77	2.3	0.8	6.2	0.33	1.79	0.99	0.584	
4T-3579/3525	56	49.5	75	81	3.5	3.3	10.0	0.31	1.96	1.08	0.807	
4T-26884/26822	55	48.5	71	74	3.5	0.8	7.4	0.32	1.88	1.04	0.511	
4T-25577/25520	55	49	74	77	3.5	0.8	6.2	0.33	1.79	0.99	0.582	
4T-12175/12303	52	49.5	68	73	1.5	1.5	-0.2	0.51	1.19	0.65	0.308	
4T-18685/18620	54	49.5	71	74	2.8	1.5	2.2	0.37	1.60	0.88	0.347	
4T-25580/25520	57	50	74	77	3.5	0.8	6.2	0.33	1.79	0.99	0.56	
4T-25582/25520	60	50	74	77	5	0.8	6.2	0.33	1.79	0.99	0.564	
4T-3578/3520	57	51	74	79.5	3.5	3.3	10.0	0.31	1.96	1.08	0.701	
4T-355/354A	54	50	77	80	2.3	1.3	5.1	0.31	1.96	1.08	0.511	
4T-3578/3525	57	51	75	81	3.5	3.3	10.0	0.31	1.96	1.08	0.78	
4T-HM803149/HM803110	62	53.4	74	85	3.5	3.3	4.6	0.55	1.10	0.60	0.85	
4T-3782/3720	58	52	82	87.9	3.5	3.3	8.3	0.34	1.77	0.97	0.959	
4T-46175/46368	55	54	79	87	0.8	3.3	7.1	0.40	1.49	0.82	1.04	
4T-33885/33821	53	53	85	90	0.8	2.3	8.0	0.33	1.82	1.00	0.986	
4T-438/432	57	51	83	87	3.5	2.3	9.2	0.28	2.11	1.16	0.957	
4T-HM804842/HM804810	57	57	81	91	0.8	3.3	3.7	0.55	1.10	0.60	1.04	
4T-53177/53375	63	52.7	81	89	3.5	0.8	0.5	0.74	0.81	0.45	0.93	
4T-HM903249/HM903210	65	54	81	91	3.5	0.8	-0.4	0.74	0.81	0.45	0.999	
4T-527/522	59	53	89	95	3.5	3.3	12.9	0.29	2.10	1.16	1.36	
4T-460/453X	60	54	92	98	3.5	3.3	7.1	0.34	1.79	0.98	1.29	

1) Dimensions with "-" indicate a load center at the outside on the end of an inner ring.

Inch series

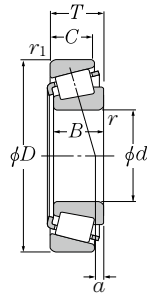

a 44.450 ~ 47.625mm

d	Boundary dimensions				Basic load rating		Allowable speed	
	mm				dynamic C _r kN	static C _{0r}	Grease lubrication min ⁻¹	Oil lubrication
	D	T	B	C				
44.450	104.775	30.162	30.958	23.812	144	169	3 500	4 700
	104.775	36.512	36.512	28.575	153	189	3 600	4 800
	111.125	30.162	26.909	20.638	115	136	3 200	4 200
	111.125	30.162	26.909	20.638	115	136	3 200	4 200
	127.000	50.800	52.388	41.275	277	320	3 200	4 300
44.983	82.931	23.812	25.400	19.050	84.5	98.0	4 500	6 000
	93.264	30.162	30.302	23.812	113	134	4 000	5 300
45.000	85.000	20.638	21.692	17.462	77.5	79.5	4 400	5 800
	88.900	20.638	22.225	16.513	85.0	90.5	4 100	5 500
45.237	87.312	30.162	30.886	23.812	104	117	4 400	5 900
45.242	73.431	19.558	19.812	15.748	60.0	76.0	4 800	6 400
	77.788	19.842	19.842	15.080	63.5	73.5	4 600	6 200
45.618	82.550	23.812	25.400	19.050	84.5	98.0	4 500	6 000
	82.931	23.812	25.400	19.050	84.5	98.0	4 500	6 000
	83.058	23.876	25.400	19.114	84.5	98.0	4 500	6 000
	85.000	23.812	25.400	19.050	84.5	98.0	4 500	6 000
45.987	74.976	18.000	18.000	14.000	56.5	71.0	4 700	6 300
46.038	79.375	17.462	17.462	13.495	50.5	56.0	4 600	6 200
	82.931	23.812	25.400	19.050	84.5	98.0	4 500	6 000
	85.000	20.638	21.692	17.462	77.5	79.5	4 400	5 800
	85.000	25.400	25.608	20.638	87.5	104	4 400	5 800
	90.119	23.000	21.692	21.808	77.5	79.5	4 400	5 800
	93.264	30.162	30.302	23.812	113	134	4 000	5 300
	95.250	27.783	29.900	22.225	120	129	4 200	5 600
47.625	88.900	20.638	22.225	16.513	85.0	90.5	4 100	5 500
	88.900	25.400	25.400	19.050	91.0	101	4 200	5 600
	93.264	30.162	30.302	23.812	113	134	4 000	5 300
	95.250	30.162	29.370	23.020	120	147	4 000	5 300
	96.838	21.000	21.946	15.875	86.5	96.5	3 700	5 000
	101.600	34.925	36.068	26.988	150	165	3 800	5 000
104.775	30.162	29.317	24.605	127	148	3 500	4 700	

Note: Chamfer dimensions on the back face of the inner and outer rings of the bearing are larger than the maximum values of installation-related dimensions r_{1a} and r_{1as} .
 1) As for the maximum value for inner and outer ring diameters of bearings whose bearing numbers are marked with "†" (inner ring) and "††" (outer ring), the precision class is an integer for class 4 and class 2 bearings only. B-168

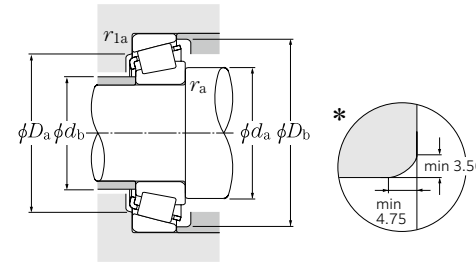

Dynamic equivalent radial load

$$P_r = X F_r + Y F_a$$

$\frac{F_a}{F_r} \leq e$		$\frac{F_a}{F_r} > e$	
X	Y	X	Y
1	0	0.4	Y_2

Static equivalent radial load

$$P_{0r} = 0.5 F_r + Y_0 F_a$$

When $P_{0r} < F_r$ use $P_{0r} = F_r$.

For values of e , Y_2 and Y_0 see the table below.

Bearing number ¹⁾	Installation-related dimensions						Load center ³⁾ mm	Constant e	Axial load factors		Mass kg (approx.)
	mm								Y ₂	Y ₀	
	d _a	d _b	D _a	D _b	r _{as} ²⁾ Max.	r _{1as} Max.					
4T-45280/45220	55	54	93	99	0.8	3.3	7.9	0.33	1.80	0.99	1.33
4T-HM807040/HM807010	66	59	89	100	3.5	3.3	7.4	0.49	1.23	0.68	1.62
4T-55175C/55437	70	64	92	105	3.5	3.3	-7.4	0.88	0.68	0.37	1.45
4T-55176C/55437	71	65	92	105	0.8	3.3	-7.4	0.88	0.68	0.37	1.09
4T-6277/6220	67	60	108	117	3.5	3.3	19.5	0.30	2.01	1.11	3.59
4T-25584/25520	53	51	74	77	1.5	0.8	6.2	0.33	1.79	0.99	0.556
4T-3776/3720	59	53	82	87.9	3.5	3.3	8.3	0.34	1.77	0.97	0.95
4T-358/354A	53	50	77	80	1.5	1.3	5.1	0.31	1.96	1.08	0.505
4T-367/362A	55	51	81	84	2	1.3	4.0	0.32	1.88	1.03	0.6
4T-3586/3525	58	52	75	81	3.5	3.3	10.0	0.31	1.96	1.08	0.767
4T-LM102949/LM102910	56	50	68	70	3.5	0.8	4.7	0.31	1.97	1.08	0.309
4T-LM603049/LM603011	58	52	71	74	3.5	0.8	2.2	0.43	1.41	0.77	0.371
4T-25590/25519	58	51	73	77	3.5	2	6.2	0.33	1.79	0.99	0.534
4T-25590/25520	58	51	74	77	3.5	0.8	6.2	0.33	1.79	0.99	0.544
4T-25590/25522	58	51	73	77	3.5	2	6.2	0.33	1.79	0.99	0.545
4T-25590/25526	58	51	74	78	3.5	2.3	6.2	0.33	1.79	0.99	0.581
4T-LM503349A†/LM503310††	57	51	67	71	*	1.5	1.9	0.40	1.49	0.82	0.298
4T-18690/18620	56	51	71	74	2.8	1.5	2.2	0.37	1.60	0.88	0.331
4T-25592/25520	58	52	74	77	3.5	0.8	6.2	0.33	1.79	0.99	0.538
4T-359A/354A	57	51	77	80	3.5	1.3	5.1	0.31	1.96	1.08	0.489
4T-2984/2924	58	52	76	80	3.5	1.3	6.4	0.35	1.73	0.95	0.616
4T-359S/352	55	51	78	82	2.3	2.3	5.1	0.31	1.96	1.08	0.654
4T-3777/3720	60	53	82	87.9	3.5	3.3	8.3	0.34	1.77	0.97	0.934
4T-436/432	59	52	83	87	3.5	2.3	9.2	0.28	2.11	1.16	0.93
4T-369A/362A	60	53	81	84	3.5	1.3	4.0	0.32	1.88	1.03	0.564
4T-M804048/M804010	59	56	77	85	0.8	3.3	1.7	0.55	1.10	0.60	0.664
4T-3778/3720	67	55	82	87.9	6.4	3.3	8.3	0.34	1.77	0.97	0.896
4T-HM804846/HM804810	66	57	81	91	3.5	3.3	3.7	0.55	1.10	0.60	0.979
4T-386A/382A	56	55	89	92	0.8	0.8	3.1	0.35	1.69	0.93	0.719
4T-528/522	62	55	89	95	3.5	3.3	12.9	0.29	2.10	1.16	1.3
4T-463/453X	65	56	92	98	4.8	3.3	7.1	0.34	1.79	0.98	1.24

2) Chamfer dimensions of the bearings marked "*" are shown in the above drawings.
 3) Dimensions with "-" indicate a load center at the outside on the end of an inner ring. B-169

Tapered Roller Bearings



Inch series
J series

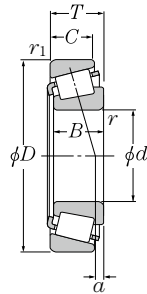

a 47.625 ~ 50.800mm

d	Boundary dimensions				Basic load rating		Allowable speed	
	mm				dynamic C _r kN	static C _{0r}	Grease lubrication min ⁻¹	Oil lubrication
	D	T	B	C				
47.625	104.775	30.162	30.958	23.812	144	169	3 500	4 700
	111.125	30.162	26.909	20.638	115	136	3 200	4 200
	123.825	36.512	32.791	25.400	171	188	2 900	3 900
48.412	95.250	30.162	29.370	23.020	120	147	4 000	5 300
	95.250	30.162	29.370	23.020	120	147	4 000	5 300
49.212	93.264	30.162	30.302	23.812	113	134	4 000	5 300
	103.188	43.658	44.475	36.512	193	232	3 800	5 000
	104.775	36.512	36.512	28.575	153	189	3 600	4 800
	114.300	44.450	44.450	34.925	206	225	3 600	4 800
49.987	82.550	21.590	22.225	16.510	77.5	94.0	4 300	5 700
	92.075	24.608	25.400	19.845	93.0	116	4 000	5 300
50.000	114.300	44.450	44.450	36.068	226	261	3 500	4 700
	82.000	21.500	21.500	17.000	77.5	94.0	4 300	5 700
	84.000	22.000	22.000	17.500	77.5	94.5	4 300	5 700
	88.900	20.638	22.225	16.513	85.0	90.5	4 100	5 500
	88.900	20.638	22.225	16.513	85.0	90.5	4 100	5 500
	90.000	28.000	28.000	23.000	118	141	4 100	5 400
	105.000	37.000	36.000	29.000	153	189	3 600	4 800
50.800	110.000	22.000	21.996	18.824	99.5	120	3 200	4 300
	82.550	21.590	22.225	16.510	77.5	94.0	4 300	5 700
	85.000	17.462	17.462	13.495	55.0	65.0	4 200	5 600
	88.900	17.462	17.462	13.495	55.0	65.0	4 200	5 600
	88.900	20.638	22.225	16.513	85.0	90.5	4 100	5 500
	88.900	20.638	22.225	16.513	85.0	90.5	4 100	5 500
	90.000	20.000	22.225	15.875	85.0	90.5	4 100	5 500
	92.075	24.608	25.400	19.845	93.0	116	4 000	5 300
	93.264	30.162	30.302	23.812	113	134	4 000	5 300
	93.264	30.162	30.302	23.812	113	134	4 000	5 300
	95.250	27.783	28.575	22.225	119	139	3 900	5 200
	95.250	30.162	30.302	23.812	113	134	4 000	5 300
	96.838	21.000	21.946	15.875	86.5	96.5	3 700	5 000
	97.630	24.608	24.608	19.446	98.0	128	3 700	4 900
98.425	30.162	30.302	23.812	113	134	4 000	5 300	

Note: Chamfer dimensions on the back face of the inner and outer rings of the bearing are larger than the maximum values of installation-related dimensions r_{1a} and r_{1as} .
1) As for the maximum value for inner ring bore diameters of bearings whose bearing numbers are marked with "T" (inner ring), the precision class is an integer for class 4 and class 2 bearings only.

Tapered Roller Bearings

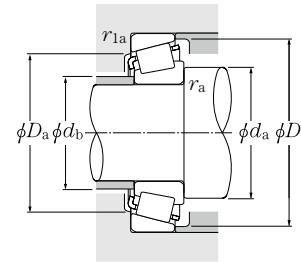

Dynamic equivalent radial load

$$P_r = X F_r + Y F_a$$

$\frac{F_a}{F_r} \leq e$		$\frac{F_a}{F_r} > e$	
X	Y	X	Y
1	0	0.4	Y_2

Static equivalent radial load

$$P_{0r} = 0.5 F_r + Y_0 F_a$$

When $P_{0r} < F_r$ use $P_{0r} = F_r$.

For values of e , Y_2 and Y_0 see the table below.

Bearing number 1) 2)	Installation-related dimensions						Load center ³⁾ mm	Constant e	Axial load factors		Mass kg (approx.)	
	mm								a	Y ₂		Y ₀
	d _a	d _b	D _a	D _b	r _{as} Max.	r _{1as} Max.						
4T-45282/45220	63	57	93	99	3.5	3.3	7.9	0.33	1.80	0.99	1.33	
4T-55187C/55437	69	62	92	105	3.5	3.3	-7.4	0.88	0.68	0.37	1.4	
4T-72188C/72487	69	67	102	116	0.8	3.3	-1.5	0.74	0.81	0.45	2.16	
4T-HM804848/HM804810	63	57	81	91	2.3	3.3	3.7	0.55	1.10	0.60	0.967	
4T-HM804849/HM804810	66	57	81	91	3.5	3.3	3.7	0.55	1.10	0.60	0.965	
4T-3781/3720	62	56	82	87.9	3.5	3.3	8.3	0.34	1.77	0.97	0.876	
4T-5395/5335	66	60	89	97	3.5	3.3	16.1	0.30	2.02	1.11	1.75	
4T-HM807044/HM807010	69	63	89	100	3.5	3.3	7.4	0.49	1.23	0.68	1.52	
4T-65390/65320	70	60	97	107	3.5	3.3	12.5	0.43	1.39	0.77	2.23	
4T-HH506348/HH506310	71	61	97	107	3.5	3.3	13.3	0.40	1.49	0.82	2.33	
4T-LM104947A†/LM104911	55	55	75	78	0.5	1.3	5.8	0.31	1.97	1.08	0.434	
4T-28579†/28521	60	56	83	87	2.3	0.8	4.6	0.38	1.59	0.87	0.718	
4T-HH506349†/HH506310	72	61	97	107	3.5	3.3	13.3	0.40	1.49	0.82	2.31	
#4T-JLM104948/JLM104910	61	55	76	78	3	0.5	5.4	0.31	1.97	1.08	0.42	
#4T-JLM704649/JLM704610	64	56	76	80	3.5	1.5	2.3	0.44	1.37	0.75	0.466	
4T-365/362A	58	55	81	84	2	1.3	4.0	0.32	1.88	1.03	0.534	
4T-366/362A	59	55	81	84	2.3	1.3	4.0	0.32	1.88	1.03	0.53	
#4T-JM205149/JM205110	63	57	80	85	3	2.5	7.4	0.33	1.82	1.00	0.755	
#4T-JHM807045/JHM807012	69	63	90	100	3	2.5	7.5	0.49	1.23	0.68	1.52	
4T-396/394A	61	60	101	105	0.8	1.3	0.7	0.40	1.49	0.82	1.07	
4T-LM104949/LM104911	63	56	75	78	3.5	1.3	5.8	0.31	1.97	1.08	0.418	
4T-18790/18720	62	56	77	80	3.5	1.5	0.8	0.41	1.48	0.81	0.375	
4T-18790/18724	62	56	78	82	3.5	1.5	0.8	0.41	1.48	0.81	0.431	
4T-368/362A	58	56	81	84	1.5	1.3	4.0	0.32	1.88	1.03	0.524	
4T-370A/362A	65	56	81	84	5	1.3	4.0	0.32	1.88	1.03	0.516	
4T-368A/362	62	56	81	84	3.5	2	4.0	0.32	1.88	1.03	0.53	
4T-28580/28521	63	57	83	87	3.5	0.8	4.6	0.38	1.59	0.87	0.703	
4T-3775/3720	58	58	82	87.9	0.8	3.3	8.3	0.34	1.77	0.97	0.85	
4T-3780/3720	64	58	82	87.9	3.5	3.3	8.3	0.34	1.77	0.97	0.846	
4T-33889/33821	64	58	85	90	3.5	2.3	8.0	0.33	1.82	1.00	0.878	
4T-3780/3726	64	58	83.1	88.9	3.5	3.3	8.3	0.34	1.77	0.97	0.899	
4T-385A/382A	61	60	89	92	2.3	0.8	3.1	0.35	1.69	0.93	0.675	
4T-28678/28622	65	58	88	92	3.5	0.8	3.3	0.40	1.49	0.82	0.854	
4T-3780/3732	64	58	84.1	89.9	3.5	3.3	8.3	0.34	1.77	0.97	0.99	

2) Bearing numbers marked with "#" designate J-series bearings. The tolerance of these bearings is listed in Table 6.8 on page A-66 to A-67.
3) Dimensions with "-" indicate a load center at the outside on the end of an inner ring.

Tapered Roller Bearings



Inch series
J series

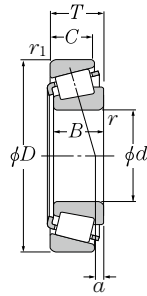

a 50.800 ~ 55.000mm

d	Boundary dimensions				Basic load rating		Allowable speed	
	mm				dynamic C _r	static C _{0r}	Grease lubrication	Oil lubrication
	D	T	B	C				
50.800	101.600	31.750	31.750	25.400	122	136	3 700	5 000
	101.600	34.925	36.068	26.988	150	165	3 800	5 000
	104.775	30.162	29.317	24.605	127	148	3 500	4 700
	104.775	30.162	30.958	23.812	144	169	3 500	4 700
	104.775	36.512	36.512	28.575	153	189	3 600	4 800
	104.775	36.512	36.512	28.575	158	178	3 700	4 900
	107.950	36.512	36.957	28.575	157	177	3 600	4 800
	111.125	30.162	28.575	20.638	115	136	3 200	4 200
	112.712	30.162	26.909	20.638	115	136	3 200	4 200
	112.712	30.162	30.048	23.812	132	174	3 200	4 300
	112.712	30.162	30.162	23.812	153	195	3 200	4 200
	117.475	33.338	31.750	23.812	144	153	3 300	4 400
	120.650	41.275	41.275	31.750	190	213	3 300	4 400
123.825	36.512	32.791	25.400	171	188	2 900	3 900	
123.825	38.100	36.678	30.162	175	216	3 000	4 100	
51.592	88.900	20.638	22.225	16.513	85.0	90.5	4 100	5 500
52.388	92.075	24.608	25.400	19.845	93.0	116	4 000	5 300
	93.264	30.162	30.302	23.812	113	134	4 000	5 300
	95.250	27.783	28.575	22.225	119	139	3 900	5 200
53.975	88.900	19.050	19.050	13.492	67.5	82.5	4 000	5 300
	95.250	27.783	28.575	22.225	119	139	3 900	5 200
	96.838	21.000	21.946	15.875	86.5	96.5	3 700	5 000
	104.775	30.162	30.958	23.812	144	169	3 500	4 700
	104.775	36.512	36.512	28.575	153	189	3 600	4 800
	107.950	36.512	36.957	28.575	157	177	3 600	4 800
	120.650	41.275	41.275	31.750	190	213	3 300	4 400
	122.238	33.338	31.750	23.812	149	163	3 100	4 200
	122.238	43.658	43.764	36.512	215	283	3 100	4 100
	123.825	36.512	32.791	25.400	171	188	2 900	3 900
	123.825	38.100	36.678	30.162	175	216	3 000	4 100
130.175	36.512	33.338	23.812	173	186	2 700	3 600	
140.030	36.512	33.236	23.520	190	212	2 600	3 400	
54.488	104.775	36.512	36.512	28.575	153	189	3 600	4 800
55.000	90.000	23.000	23.000	18.500	86.0	109	3 900	5 300

Note: Chamfer dimensions on the back face of the inner and outer rings of the bearing are larger than the maximum values of installation-related dimensions r_{as} and r_{1as} .

Tapered Roller Bearings

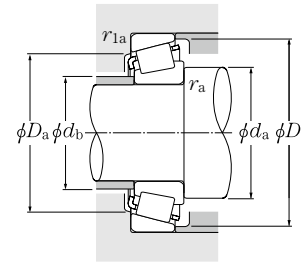

Dynamic equivalent radial load

$$P_r = X F_r + Y F_a$$

$\frac{F_a}{F_r} \leq e$		$\frac{F_a}{F_r} > e$	
X	Y	X	Y
1	0	0.4	Y_2

Static equivalent radial load

$$P_{0r} = 0.5 F_r + Y_0 F_a$$

When $P_{0r} < F_r$ use $P_{0r} = F_r$.

For values of e , Y_2 and Y_0 see the table below.

Bearing number ¹⁾	Installation-related dimensions						Load center ²⁾ mm	Constant e	Axial load factors		Mass kg (approx.)
	mm								Y_2	Y_0	
	d_a	d_b	D_a	D_b	r_{as} Max.	r_{1as} Max.	a	e	Y_2	Y_0	
4T-49585/49520	66	59	88	96	3.5	3.3	7.1	0.40	1.50	0.82	1.13
4T-529/522	61	60	89	95	0.8	3.3	12.9	0.29	2.10	1.16	1.23
4T-455/453X	60	59	92	98	0.8	3.3	7.1	0.34	1.79	0.98	1.19
4T-45284/45220	71	59	93	99	6.4	3.3	7.9	0.33	1.80	0.99	1.24
4T-HM807046/HM807010	70	63.1	89	100	3.5	3.3	7.4	0.49	1.23	0.68	1.48
4T-59200/59412	68	61	92	99	3.5	3.3	9.6	0.40	1.49	0.82	1.44
4T-537/532X	65	59	94	100	3.5	3.3	12.3	0.30	2.02	1.11	1.55
4T-HM907643/HM907614	74	65.3	91	105	3.5	3.3	-7.2	0.88	0.68	0.37	1.36
4T-55200C/55443	71	64.4	92	106	3.5	3.3	-7.4	0.88	0.68	0.37	1.34
4T-3975/3920	68	61	99	106	3.5	3.3	4.5	0.40	1.49	0.82	1.53
4T-39575/39520	68	61	101	107	3.5	3.3	6.6	0.34	1.77	0.97	1.54
4T-66200/66462	71	65	100	111	3.5	3.3	0.4	0.63	0.96	0.53	1.68
4T-619/612	67	61	105	110	3.5	3.3	14.4	0.31	1.91	1.05	2.3
4T-72200C/72487	77	67	102	116	3.5	3.3	-1.5	0.74	0.81	0.45	2.1
4T-555/552A	66	62	109	116	2.3	3.3	9.4	0.35	1.73	0.95	2.34
4T-368S/362A	59	56	81	84	2	1.3	4.0	0.32	1.88	1.03	0.512
4T-28584/28521	65	58	83	87	3.5	0.8	4.6	0.38	1.59	0.87	0.703
4T-3767/3720	63	59	82	87.9	2.3	3.3	8.3	0.34	1.77	0.97	0.817
4T-33890/33821	61	59	85	90	1.5	2.3	8.0	0.33	1.82	1.00	0.851
4T-LM806649/LM806610	65	61	80	85	2.3	2	-2.2	0.55	1.10	0.60	0.437
4T-33895/33822	63	60	86	90	1.5	0.8	8.0	0.33	1.82	1.00	0.823
4T-389A/382A	61	60	89	92	0.8	0.8	3.1	0.35	1.69	0.93	0.632
4T-45287/45220	62	62	93	99	0.8	3.3	7.9	0.33	1.80	0.99	1.17
4T-HM807049/HM807010	73	63.1	89	100	3.5	3.3	7.4	0.49	1.23	0.68	1.41
4T-539/532X	68	61	94	100	3.5	3.3	12.3	0.30	2.02	1.11	1.47
4T-621/612	70	63	105	110	3.5	3.3	14.4	0.31	1.91	1.05	2.22
4T-66584/66520	75	68	105	116	3.5	3.3	-1.8	0.67	0.90	0.50	1.81
4T-5578/5535	73	67	106	116	3.5	3.3	13.3	0.36	1.67	0.92	2.64
4T-72212C/72487	79	67	102	116	3.5	3.3	-1.5	0.74	0.81	0.45	2.03
4T-5575/552A	73	67	109	116	3.5	3.3	9.4	0.35	1.73	0.95	2.25
4T-HM911242/HM911210	79	74	109	123.6	3.5	3.3	-5.2	0.82	0.73	0.40	2.28
4T-78214C/78551	79	77.5	117	132	0.8	2.3	-8.5	0.87	0.69	0.38	2.77
4T-HM807048/HM807010	73	63	89	100	3.5	3.3	7.4	0.49	1.23	0.68	1.4
#4T-JLM506849/JLM506810	63	61	82	86	1.5	0.5	2.8	0.40	1.49	0.82	0.556

1) Bearing numbers marked "#" designate J-series bearings. The tolerance of these bearings is listed in Table 6.8 on page A-66 to A-67.
2) Dimensions with "-" indicate a load center at the outside on the end of an inner ring.

Tapered Roller Bearings



Inch series
J series

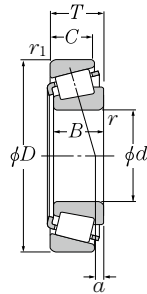

a 55.000 ~ 60.000mm

	Boundary dimensions				Basic load rating		Allowable speed	
	mm				dynamic C _r kN	static C _{0r}	Grease lubrication min ⁻¹	Oil lubrication
	d	D	T	B				
55.000	95.000	29.000	29.000	23.500	119	144	3 800	5 100
	96.838	21.000	21.946	15.875	86.5	96.5	3 700	5 000
	110.000	39.000	39.000	32.000	192	219	3 500	4 600
55.562	97.630	24.608	24.608	19.446	98.0	128	3 700	4 900
	123.825	36.512	32.791	25.400	171	188	2 900	3 900
	127.000	36.512	36.512	26.988	181	228	2 900	3 800
55.575	96.838	21.000	21.946	15.875	86.5	96.5	3 700	5 000
57.150	96.838	21.000	21.946	15.875	86.5	96.5	3 700	5 000
	96.838	21.000	21.946	15.875	86.5	96.5	3 700	5 000
	96.838	21.000	21.946	15.875	86.5	96.5	3 700	5 000
	96.838	21.000	21.946	15.875	86.5	96.5	3 700	5 000
	97.630	24.608	24.608	19.446	98.0	128	3 700	4 900
	104.775	30.162	29.317	24.605	127	148	3 500	4 700
	104.775	30.162	29.317	24.605	127	148	3 500	4 700
	104.775	30.162	30.958	23.812	144	169	3 500	4 700
	107.950	27.783	29.317	22.225	127	148	3 500	4 700
	110.000	22.000	21.996	18.824	99.5	120	3 200	4 300
	110.000	27.795	29.317	27.000	127	148	3 500	4 700
	112.712	30.162	30.048	23.812	132	174	3 200	4 300
	112.712	30.162	30.162	23.812	153	195	3 200	4 200
	112.712	30.162	30.162	23.812	153	195	3 200	4 200
	117.475	30.162	30.162	23.812	129	175	3 000	4 000
	117.475	33.338	31.750	23.812	144	153	3 300	4 400
	120.650	41.275	41.275	31.750	190	213	3 300	4 400
123.825	36.512	32.791	25.400	171	188	2 900	3 900	
123.825	38.100	36.678	30.162	175	216	3 000	4 100	
140.030	36.512	33.236	23.520	190	212	2 600	3 400	
57.531	96.838	21.000	21.946	15.875	86.5	96.5	3 700	5 000
59.972	122.238	33.338	31.750	23.812	149	163	3 100	4 200
59.987	146.050	41.275	39.688	25.400	220	234	2 400	3 200
60.000	95.000	24.000	24.000	19.000	92.5	122	3 700	4 900
	107.950	25.400	25.400	19.050	101	140	3 200	4 300

Note: Chamfer dimensions on the back face of the inner and outer rings of the bearing are larger than the maximum values of installation-related dimensions r_{1a} and r_{1as} .
1) As for the maximum value for inner ring bore diameters of bearings whose bearing numbers are marked with "T" (inner ring), the precision class is an integer for class 4 and class 2 bearings only.

Tapered Roller Bearings

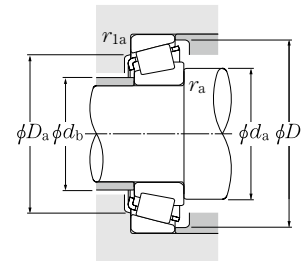

Dynamic equivalent radial load

$$P_r = X F_r + Y F_a$$

$\frac{F_a}{F_r} \leq e$		$\frac{F_a}{F_r} > e$	
X	Y	X	Y
1	0	0.4	Y_2

Static equivalent radial load

$$P_{0r} = 0.5 F_r + Y_0 F_a$$

When $P_{0r} < F_r$ use $P_{0r} = F_r$.

For values of e , Y_2 and Y_0 see the table below.

Bearing number 1) 2)	Installation-related dimensions						Load center ³⁾ mm	Constant e	Axial load factors		Mass kg (approx.)
	mm								Y ₂	Y ₀	
	d _a	d _b	D _a	D _b	r _{as} Max.	r _{1as} Max.					
#4T-JM207049/JM207010	64	62	85	91	1.5	2.5	7.6	0.33	1.79	0.99	0.823
4T-385/382A	65	61	89	92	2.3	0.8	3.1	0.35	1.69	0.93	0.615
#4T-JH307749/JH307710	71	64	97	104	3	2.5	11.7	0.35	1.73	0.95	1.7
4T-28680/28622	68	62	88	92	3.5	0.8	3.3	0.40	1.49	0.82	0.776
4T-72218C/72487	80	67	102	116	3.5	3.3	-1.5	0.74	0.81	0.45	2
4T-HM813840/HM813810	78	72	111	121	3.5	3.3	3.7	0.50	1.20	0.66	2.34
4T-389/382A	65	61	89	92	2.3	0.8	3.1	0.35	1.69	0.93	0.606
4T-387/382A	67	63	89	92	2.3	0.8	3.1	0.35	1.69	0.93	0.582
4T-387A/382A	70	63	89	92	3.5	0.8	3.1	0.35	1.69	0.93	0.58
4T-387AS/382A	73	63	89	92	5	0.8	3.1	0.35	1.69	0.93	0.575
4T-387S/382A	64	63	89	92	0.8	0.8	3.1	0.35	1.69	0.93	0.584
4T-28682/28622	70	63	88	92	3.5	0.8	3.3	0.40	1.49	0.82	0.749
4T-462/453X	67	63	92	98	2.3	3.3	7.1	0.34	1.79	0.98	1.06
4T-469/453X	72	68	92	98	3.5	3.3	7.1	0.34	1.79	0.98	1.06
4T-45289/45220	65	65	93	99	0.8	3.3	7.9	0.33	1.80	0.99	1.1
4T-469/453A	72	68	97	100	3.5	0.8	7.1	0.34	1.79	0.98	1.11
4T-390/394A	70	66	101	105	2.3	1.3	0.7	0.40	1.49	0.82	0.961
4T-469/454	72	68	96	100	3.5	2	7.1	0.34	1.79	0.98	1.24
4T-3979/3920	72	66	99	106	3.5	3.3	4.5	0.40	1.49	0.82	1.41
4T-39580/39520	74	68	101	107	3.5	3.3	6.6	0.34	1.77	0.97	1.41
4T-39581/39520	81	66	101	107	8	3.3	6.6	0.34	1.77	0.97	1.4
4T-33225/33462	74	68	104	112	3.5	3.3	2.6	0.44	1.38	0.76	1.58
4T-66225/66462	76	68.9	100	111	3.5	3.3	0.4	0.63	0.96	0.53	1.54
4T-623/612	72	66	105	110	3.5	3.3	14.4	0.31	1.91	1.05	2.13
4T-72225C/72487	81	67	102	116	3.5	3.3	-1.5	0.74	0.81	0.45	1.96
4T-555S/552A	76	70	109	116	3.5	3.3	9.4	0.35	1.73	0.95	2.17
4T-78225/78551	83	77	117	132	3.5	2.3	-8.5	0.87	0.69	0.38	2.69
4T-388A/382A	70	63	89	92	3.5	0.8	3.1	0.35	1.69	0.93	0.574
4T-66589/66520	74	73	105	116	0.8	3.3	-1.8	0.67	0.90	0.50	1.66
4T-H913840†/H913810	97	82	124	138	3.5	3.3	-4.3	0.78	0.77	0.42	3.22
#4T-JLM508748/JLM508710	75	66	85	91	5	2.5	3.0	0.40	1.49	0.82	0.609
4T-29580/29520	75	68	96	103	3.5	3.3	0.6	0.46	1.31	0.72	0.992

2) Bearing numbers marked with "#" designate J-series bearings. The tolerance of these bearings is listed in Table 6.8 on page A-66 to A-67.
3) Dimensions with "-" indicate a load center at the outside on the end of an inner ring.

Tapered Roller Bearings



Inch series
J series

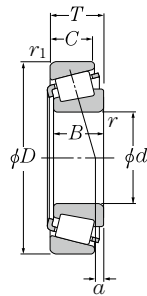

a 60.000 ~ 65.000mm

d	Boundary dimensions				Basic load rating		Allowable speed	
	mm				dynamic C _r	static C _{0r}	Grease lubrication	Oil lubrication
	D	T	B	C				
60.000	110.000	22.000	21.996	18.824	99.5	120	3 200	4 300
	130.000	34.100	30.924	22.650	173	186	2 700	3 600
60.325	100.000	25.400	25.400	19.845	100	134	3 500	4 700
	112.712	30.162	30.048	23.812	132	174	3 200	4 300
	122.238	38.100	38.354	29.718	208	244	3 100	4 100
	122.238	43.658	43.764	36.512	215	283	3 100	4 100
	123.825	38.100	36.678	30.162	175	216	3 000	4 100
	127.000	36.512	36.512	26.988	181	228	2 900	3 800
	127.000	44.450	44.450	34.925	226	263	3 100	4 200
130.175	36.512	33.338	23.812	173	186	2 700	3 600	
61.912	110.000	22.000	21.996	18.824	99.5	120	3 200	4 300
	136.525	46.038	46.038	36.512	248	355	2 600	3 500
	146.050	41.275	39.688	25.400	220	234	2 400	3 200
61.976	101.600	24.608	24.608	19.845	100	134	3 500	4 700
62.738	101.600	25.400	25.400	19.845	100	134	3 500	4 700
63.500	94.458	19.050	19.050	15.083	67.0	103	3 600	4 800
	107.950	25.400	25.400	19.050	101	140	3 200	4 300
	107.950	25.400	25.400	19.050	101	140	3 200	4 300
	110.000	22.000	21.996	18.824	99.5	120	3 200	4 300
	110.000	25.400	25.400	19.050	101	140	3 200	4 300
	112.712	30.162	30.048	23.812	132	174	3 200	4 300
	112.712	30.162	30.162	23.812	153	195	3 200	4 200
	120.000	29.794	29.007	24.237	142	177	3 000	4 000
	120.000	29.794	29.007	24.237	142	177	3 000	4 000
	122.238	38.100	38.354	29.718	208	244	3 100	4 100
	122.238	43.658	43.764	36.512	215	283	3 100	4 100
	123.825	38.100	36.678	30.162	175	216	3 000	4 100
	127.000	36.512	36.170	28.575	181	229	2 900	3 800
	127.000	36.512	36.512	26.988	181	228	2 900	3 800
	136.525	41.275	41.275	31.750	215	262	2 800	3 800
	140.030	36.512	33.236	23.520	190	212	2 600	3 400
65.000	105.000	24.000	23.000	18.500	94.5	117	3 300	4 500
	110.000	28.000	28.000	22.500	132	174	3 200	4 300

Note: Chamfer dimensions on the back face of the inner and outer rings of the bearing are larger than the maximum values of installation-related dimensions r_{as} and r_{1as} .

Tapered Roller Bearings

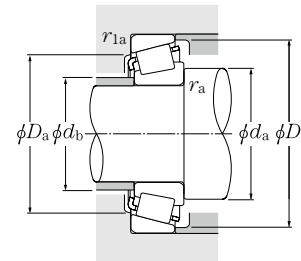

Dynamic equivalent radial load

$$P_r = X F_r + Y F_a$$

$\frac{F_a}{F_r} \leq e$		$\frac{F_a}{F_r} > e$	
X	Y	X	Y
1	0	0.4	Y_2

Static equivalent radial load

$$P_{0r} = 0.5 F_r + Y_0 F_a$$

When $P_{0r} < F_r$ use $P_{0r} = F_r$.

For values of e , Y_2 and Y_0 see the table below.

Bearing number ¹⁾	Installation-related dimensions						Load center ²⁾ mm	Constant e	Axial load factors		Mass kg (approx.)
	mm								Y_2	Y_0	
	d_a	d_b	D_a	D_b	r_{as} Max.	r_{1as} Max.	a	e	Y_2	Y_0	
4T-397/394A	69	68	101	105	0.8	1.3	0.7	0.40	1.49	0.82	0.918
#4T-JHM911244/JHM911211	84	74	109	123	3.5	3.3	-7.6	0.82	0.73	0.40	2.01
4T-28985/28921	73	67	89	96	3.5	3.3	2.5	0.43	1.41	0.78	0.769
4T-3980/3920	75	68	99	106	3.5	3.3	4.5	0.40	1.49	0.82	1.34
4T-HM212044/HM212011	85	70	108	116	8	3.3	11.1	0.34	1.78	0.98	2.02
4T-5583/5535	78	72	106	116	3.5	3.3	13.3	0.36	1.67	0.92	2.45
4T-558/552A	76	72	109	116	2.3	3.3	9.4	0.35	1.73	0.95	2.09
4T-HM813841/HM813810	83	77	111	121	3.5	3.3	3.7	0.50	1.20	0.66	2.21
4T-65237/65500	87	71	107	119	3.5	3.3	9.3	0.49	1.23	0.68	2.59
4T-HM911245/HM911210	93	74	109	123.6	5	3.3	-5.2	0.82	0.73	0.40	2.12
4T-392/394A	70	69	101	105	0.8	1.3	0.7	0.40	1.49	0.82	0.88
4T-H715334/H715311	87	81	118	132	3.5	3.3	8.7	0.47	1.27	0.70	3.47
4T-H913842/H913810	90	82.4	124	138	3.5	3.3	-4.3	0.78	0.77	0.42	3.17
4T-28990/28920	72	68	90	97	2	3.3	1.7	0.43	1.41	0.78	0.766
4T-28995/28920	75	69	90	97	3.5	3.3	2.5	0.43	1.41	0.78	0.762
4T-L610549/L610510	71	69	86	91	1.5	1.5	-0.6	0.42	1.41	0.78	0.453
4T-29585/29520	77	71	96	103	3.5	3.3	0.6	0.46	1.31	0.72	0.924
4T-29586/29520	73	71	96	103	1.5	3.3	0.6	0.46	1.31	0.72	0.93
4T-390A/394A	73	70	101	105	1.5	1.3	0.7	0.40	1.49	0.82	0.858
4T-29585/29521	77	71	99	104	3.5	1.3	0.6	0.46	1.31	0.72	0.982
4T-3982/3920	77	71	99	106	3.5	3.3	4.5	0.40	1.49	0.82	1.27
4T-39585/39520	77	71	101	107	3.5	3.3	6.6	0.34	1.77	0.97	1.27
4T-477/472	73	72	107	114	0.8	2	3.9	0.38	1.56	0.86	1.6
4T-483/472	78	72	107	114	3.5	2	3.9	0.38	1.56	0.86	1.43
4T-HM212046/HM212011	80	73	108	116	3.5	3.3	11.1	0.34	1.78	0.98	1.95
4T-5584/5535	81	75	106	116	3.5	3.3	13.3	0.36	1.67	0.92	2.34
4T-559/552A	81	75	109	116	3.5	3.3	9.4	0.35	1.73	0.95	2.01
4T-565/563	80	73	112	120	3.5	3.3	8.3	0.36	1.65	0.91	2.11
4T-HM813842/HM813810	84	78	111	121	3.5	3.3	3.7	0.50	1.20	0.66	2.13
4T-639/632	81	74	118	125	3.5	3.3	11.4	0.36	1.66	0.91	2.85
4T-78250/78551	85	79	117	132	2.3	2.3	-8.5	0.87	0.69	0.38	2.54
#4T-JLM710949/JLM710910	77	71	96	100.5	3	1	0.3	0.45	1.32	0.73	0.744
#4T-JM511946/JM511910	78	72	99	105	3	2.5	3.4	0.40	1.49	0.82	1.09

1) Bearing numbers marked with “#” designate J-series bearings. The tolerance of these bearings is listed in Table 6.8 on page A-66 to A-67.
2) Dimensions with “-” indicate a load center at the outside on the end of an inner ring.

Tapered Roller Bearings



Inch series
J series

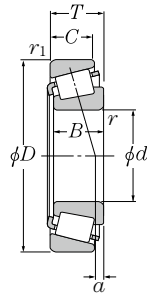

a 65.000 ~ 70.000mm

d	Boundary dimensions				Basic load rating		Allowable speed	
	mm				dynamic C _r kN	static C _{0r}	Grease lubrication min ⁻¹	Oil lubrication
	D	T	B	C				
65.000	120.000	39.000	38.500	32.000	205	248	3 100	4 100
65.088	135.755	53.975	56.007	44.450	310	380	2 900	3 800
66.675	103.213	17.602	17.602	11.989	66.5	78.0	3 300	4 400
	107.950	25.400	25.400	19.050	101	140	3 200	4 300
	110.000	22.000	21.996	18.824	99.5	120	3 200	4 300
	112.712	30.162	30.048	23.812	132	174	3 200	4 300
	112.712	30.162	30.048	23.812	132	174	3 200	4 300
	112.712	30.162	30.162	23.812	153	195	3 200	4 200
	122.238	38.100	38.354	29.718	208	244	3 100	4 100
	123.825	38.100	36.678	30.162	175	216	3 000	4 100
	127.000	36.512	36.512	26.988	181	228	2 900	3 800
	130.175	41.275	41.275	31.750	215	262	2 800	3 800
	135.755	53.975	56.007	44.450	310	380	2 900	3 800
	136.525	41.275	41.275	31.750	215	262	2 800	3 800
136.525	41.275	41.275	31.750	251	293	2 700	3 700	
68.262	110.000	22.000	21.996	18.824	99.5	120	3 200	4 300
	120.000	29.794	29.007	24.237	142	177	3 000	4 000
	123.825	38.100	36.678	30.162	175	216	3 000	4 100
	136.525	41.275	41.275	31.750	251	293	2 700	3 700
	136.525	46.038	46.038	36.512	248	355	2 600	3 500
69.850	112.712	25.400	25.400	19.050	106	151	3 100	4 100
	117.475	30.162	30.162	23.812	129	175	3 000	4 000
	120.000	29.794	29.007	24.237	142	177	3 000	4 000
	120.000	32.545	32.545	26.195	163	214	3 000	4 000
	120.650	25.400	25.400	19.050	106	151	3 100	4 100
	127.000	36.512	36.170	28.575	181	229	2 900	3 800
	136.525	41.275	41.275	31.750	215	262	2 800	3 800
	146.050	41.275	41.275	31.750	228	295	2 500	3 300
	150.089	44.450	46.672	36.512	289	360	2 400	3 200
	168.275	53.975	56.363	41.275	375	460	2 200	3 000
69.952	121.442	24.608	23.012	17.462	101	127	2 900	3 800
70.000	110.000	26.000	25.000	20.500	108	150	3 200	4 200
	115.000	29.000	29.000	23.000	138	171	3 100	4 100

Note: Chamfer dimensions on the back face of the inner and outer rings of the bearing are larger than the maximum values of installation-related dimensions r_{as} and r_{1as} .

Tapered Roller Bearings

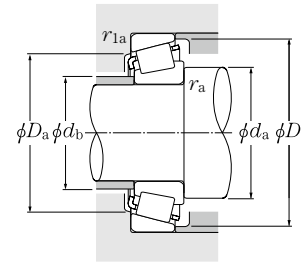

Dynamic equivalent radial load

$$P_r = X F_r + Y F_a$$

$\frac{F_a}{F_r} \leq e$		$\frac{F_a}{F_r} > e$	
X	Y	X	Y
1	0	0.4	Y_2

Static equivalent radial load

$$P_{0r} = 0.5 F_r + Y_0 F_a$$

When $P_{0r} < F_r$ use $P_{0r} = F_r$.

For values of e , Y_2 and Y_0 see the table below.

Bearing number ¹⁾	Installation-related dimensions						Load center ²⁾ mm	Constant e	Axial load factors		Mass kg (approx.)
	mm								Y ₂	Y ₀	
	d _a	d _b	D _a	D _b	r _{as} Max.	r _{1as} Max.					
#4T-JH211749/JH211710	80	74	107	114	3	2.5	10.9	0.34	1.78	0.98	1.9
4T-6379/6320	84	77	117	126	3.5	3.3	18.8	0.32	1.85	1.02	3.71
4T-L812148/L812111	75	72	96	99	1.5	0.8	-3.7	0.49	1.23	0.68	0.48
4T-29590/29520	80	73	96	103	3.5	3.3	0.6	0.46	1.31	0.72	0.86
4T-395A/394A	73	73	101	105	0.8	1.3	0.7	0.40	1.49	0.82	0.803
4T-3984/3925	80	74	101	106	3.5	0.8	4.5	0.40	1.49	0.82	1.19
4T-3994/3920	86	75	99	106	5.5	3.3	4.5	0.40	1.49	0.82	1.18
4T-39590/39520	82	75	101	107	3.5	3.3	6.6	0.34	1.77	0.97	1.28
4T-HM212049/HM212010	82	75.5	110	116	3.5	1.5	11.1	0.34	1.78	0.98	1.84
4T-560/552A	84	77	109	116	3.5	3.3	9.4	0.35	1.73	0.95	1.9
4T-HM813844/HM813810	88	82	111	121	3.5	3.3	3.7	0.50	1.20	0.66	2.03
4T-641/633	83	77	116	124	3.5	3.3	11.4	0.36	1.66	0.91	2.41
4T-6386/6320	87	77	117	126	4.3	3.3	18.8	0.32	1.85	1.02	3.64
4T-641/632	83	77	118	125	3.5	3.3	11.4	0.36	1.66	0.91	2.75
4T-H414242/H414210	85	81	121	129	3.5	3.3	11.0	0.36	1.67	0.92	2.75
4T-399A/394A	78	74	101	105	2.3	1.3	0.7	0.40	1.49	0.82	0.772
4T-480/472	82	75	107	114	3.5	2	3.9	0.38	1.56	0.86	1.13
4T-560S/552A	83	76	109	116	3.5	3.3	9.4	0.35	1.73	0.95	1.87
4T-H414245/H414210	86	82	121	129	3.5	3.3	11.0	0.36	1.67	0.92	2.7
4T-H715343/H715311	92	86	118	132	3.5	3.3	8.7	0.47	1.27	0.70	3.23
4T-29675/29620	80	77	101	109	1.5	3.3	-0.9	0.49	1.23	0.68	0.95
4T-33275/33462	85	79	104	112	3.5	3.3	2.6	0.44	1.38	0.76	1.28
4T-482/472	83	77	107	114	3.5	2	3.9	0.38	1.56	0.86	1.33
4T-47487/47420	84	78	107	114	3.5	3.3	6.1	0.36	1.67	0.92	1.63
4T-29675/29630	80	77	104	113	1.5	3.3	-0.9	0.49	1.23	0.68	1.17
4T-566/563	85	78	112	120	3.5	3.3	8.3	0.36	1.65	0.91	1.91
4T-643/632	86	80	118	125	3.5	3.3	11.4	0.36	1.66	0.91	2.63
4T-655/653	88	82	131	139	3.5	3.3	8.0	0.41	1.47	0.81	3.28
4T-745A/742	88	82	134	142	3.5	3.3	12.0	0.33	1.84	1.01	3.93
4T-835/832	91	84	149	155	3.5	3.3	18.5	0.30	2.00	1.10	6.14
4T-34274/34478	81	78	110	116	2	2	-1.2	0.45	1.33	0.73	1.11
#4T-JLM813049/JLM813010	78	77	98	105	1	2.5	-0.3	0.49	1.23	0.68	0.888
#4T-JM612949/JM612910	83	77	103	110	3	2.5	2.5	0.43	1.39	0.77	1.12

1) Bearing numbers marked "#" designate J-series bearings. The tolerance of these bearings is listed in Table 6.8 on page A-66 to A-67.
2) Dimensions with "-" indicate a load center at the outside on the end of an inner ring.

Inch series
J series

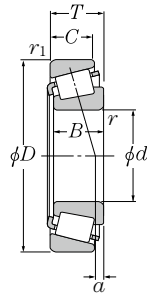

a 70.000 ~ 76.200mm

d	Boundary dimensions				Basic load rating		Allowable speed	
	mm				dynamic C _r	static C _{0r}	Grease lubrication	Oil lubrication
	D	T	B	C				
70.000	120.000	29.794	29.007	24.237	142	177	3 000	4 000
	150.000	41.275	39.688	25.400	220	234	2 400	3 200
71.438	117.475	30.162	30.162	23.812	129	175	3 000	4 000
	120.000	32.545	32.545	26.195	163	214	3 000	4 000
	127.000	36.512	36.170	28.575	181	229	2 900	3 800
	136.525	41.275	41.275	31.750	215	262	2 800	3 800
	136.525	41.275	41.275	31.750	251	293	2 700	3 700
	136.525	46.038	46.038	36.512	248	355	2 600	3 500
73.025	112.712	25.400	25.400	19.050	106	151	3 100	4 100
	117.475	30.162	30.162	23.812	129	175	3 000	4 000
	127.000	36.512	36.170	28.575	181	229	2 900	3 800
	139.992	36.512	36.098	28.575	197	265	2 600	3 400
	149.225	53.975	54.229	44.450	320	410	2 500	3 400
	150.089	44.450	46.672	36.512	289	360	2 400	3 200
73.817	112.712	25.400	25.400	19.050	106	151	3 100	4 100
	127.000	36.512	36.170	28.575	181	229	2 900	3 800
74.612	139.992	36.512	36.098	28.575	197	265	2 600	3 400
75.000	115.000	25.000	25.000	19.000	105	143	3 000	4 000
	120.000	31.000	29.500	25.000	145	197	2 900	3 900
	145.000	51.000	51.000	42.000	320	410	2 500	3 400
76.200	109.538	19.050	19.050	15.083	70.0	115	3 100	4 100
	121.442	24.608	23.012	17.462	101	127	2 900	3 800
	121.442	24.608	23.012	17.462	101	127	2 900	3 800
	127.000	30.162	31.000	22.225	150	194	2 800	3 700
	133.350	33.338	33.338	26.195	170	235	2 600	3 500
	133.350	39.688	39.688	32.545	196	305	2 600	3 500
	135.733	44.450	46.100	34.925	235	330	2 700	3 500
	136.525	30.162	29.769	22.225	143	189	2 600	3 500
	139.992	36.512	36.098	28.575	197	265	2 600	3 400
	139.992	36.512	36.098	28.575	197	265	2 600	3 400
	146.050	41.275	41.275	31.750	228	295	2 500	3 300
	149.225	53.975	54.229	44.450	320	410	2 500	3 400
	150.089	44.450	46.672	36.512	289	360	2 400	3 200

Note: Chamfer dimensions on the back face of the inner and outer rings of the bearing are larger than the maximum values of installation-related dimensions r_{as} and r_{1as} .

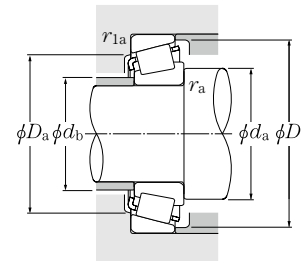

Dynamic equivalent radial load

$$P_r = X F_r + Y F_a$$

$\frac{F_a}{F_r} \leq e$		$\frac{F_a}{F_r} > e$	
X	Y	X	Y
1	0	0.4	Y_2

Static equivalent radial load

$$P_{0r} = 0.5 F_r + Y_0 F_a$$

When $P_{0r} < F_r$ use $P_{0r} = F_r$.

For values of e , Y_2 and Y_0 see the table below.

Bearing number ¹⁾	Installation-related dimensions						Load center ²⁾ mm	Constant e	Axial load factors		Mass kg (approx.)
	mm								Y_2	Y_0	
	d_a	d_b	D_a	D_b	r_{as} Max.	r_{1as} Max.	a	e	Y_2	Y_0	
4T-484/472	80	77	107	114	2	2	3.9	0.38	1.56	0.86	1.33
#4T-JH913848/JH913811	92	82.3	126	146	2	3.3	-4.3	0.78	0.77	0.42	3.09
4T-33281/33462	87	80	104	112	3.5	3.3	2.6	0.44	1.38	0.76	1.24
4T-47490/47420	86	79	107	114	3.5	3.3	6.1	0.36	1.67	0.92	1.42
4T-567A/563	86	80	112	120	3.5	3.3	8.3	0.36	1.65	0.91	1.87
4T-644/632	87	81	118	125	3.5	3.3	11.4	0.36	1.66	0.91	2.58
4T-H414249/H414210	89	83.3	121	129	3.5	3.3	11.0	0.36	1.67	0.92	2.58
4T-H715345/H715311	94	88	118	132	3.5	3.3	8.7	0.47	1.27	0.70	3.11
4T-29685/29620	86	80	101	109	3.5	3.3	-0.9	0.49	1.23	0.68	0.874
4T-33287/33462	88	81	104	112	3.5	3.3	2.6	0.44	1.38	0.76	1.19
4T-567/563	88	81	112	120	3.5	3.3	8.3	0.36	1.65	0.91	1.82
4T-576/572	90	83	125	133	3.5	3.3	5.5	0.40	1.49	0.82	2.52
4T-6460/6420	93	87	129	140	3.5	3.3	14.8	0.36	1.66	0.91	4.43
4T-744/742	91	85	134	142	3.5	3.3	12.0	0.33	1.84	1.01	3.8
4T-29688/29620	83	80	101	109	1.5	3.3	-0.9	0.49	1.23	0.68	0.862
4T-568/563	83	82	112	120	0.8	3.3	8.3	0.36	1.65	0.91	1.8
4T-577/572	91	85	125	133	3.5	3.3	5.5	0.40	1.49	0.82	2.47
#4T-JLM714149/JLM714110	88	82	104	110.5	3	2.5	-0.3	0.46	1.31	0.72	0.88
#4T-JM714249/JM714210	88	82.9	108	115	3	2.5	1.9	0.44	1.35	0.74	1.29
#4T-JH415647/JH415610	94	89	129	139	3	2.5	14.1	0.36	1.66	0.91	3.82
4T-L814749/L814710	84	82	100	105	1.5	1.5	-5.0	0.50	1.20	0.66	0.579
4T-34300/34478	86	83	110	116	2	2	-1.2	0.45	1.33	0.73	0.978
4T-34301/34478	89	83	110	116	3.5	2	-1.2	0.45	1.33	0.73	0.978
4T-42687/42620	90	84	114	121	3.5	3.3	2.8	0.42	1.43	0.79	1.46
4T-47678/47620	97	85	119	128	6.4	3.3	3.9	0.40	1.48	0.82	1.92
4T-HM516442/HM516410	93	87	118	128	3.5	3.3	7.5	0.40	1.49	0.82	2.43
4T-5760/5735	94	88	119	130	3.5	3.3	11.0	0.41	1.48	0.81	2.75
4T-495A/493	92	86	122	130	3.5	3.3	0.7	0.44	1.35	0.74	1.83
4T-575/572	92	86	125	133	3.5	3.3	5.5	0.40	1.49	0.82	2.42
4T-575S/572	99	86	125	133	6.8	3.3	5.5	0.40	1.49	0.82	2.4
4T-659/653	93	87	131	139	3.5	3.3	8.0	0.41	1.47	0.81	3.04
4T-6461A/6420	108	89	129	140	9.7	3.3	14.8	0.36	1.66	0.91	4.24
4T-748S/742	93	87	134	142	3.5	3.3	12.0	0.33	1.84	1.01	3.65

1) Bearing numbers marked "#" designate J-series bearings. The tolerance of these bearings is listed in Table 6.8 on page A-66 to A-67.
2) Dimensions with "-" indicate a load center at the outside on the end of an inner ring.

Tapered Roller Bearings



Inch series
J series

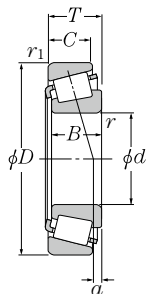

a 76.200 ~ 83.345mm

	Boundary dimensions				Basic load rating		Allowable speed	
	mm				dynamic C _r kN	static C _{0r}	Grease lubrication min ⁻¹	Oil lubrication
	d	D	T	B				
76.200	149.225	53.975	54.229	44.450	320	410	2 500	3 400
	161.925	53.975	55.100	42.862	340	460	2 300	3 000
	180.975	53.975	53.183	35.720	360	415	1 900	2 600
	190.500	57.150	57.531	46.038	490	610	1 900	2 600
77.788	117.475	25.400	25.400	19.050	110	162	2 900	3 900
	121.442	24.608	23.012	17.462	101	127	2 900	3 800
	127.000	30.162	31.000	22.225	150	194	2 800	3 700
	136.525	30.162	29.769	22.225	143	189	2 600	3 500
	136.525	46.038	46.038	36.512	248	355	2 600	3 500
79.375	146.050	41.275	41.275	31.750	228	295	2 500	3 300
	161.925	47.625	48.260	38.100	299	385	2 300	3 100
	190.500	57.150	57.531	46.038	490	610	1 900	2 600
80.000	130.000	35.000	34.000	28.500	184	249	2 700	3 600
80.962	133.350	33.338	33.338	26.195	170	235	2 600	3 500
	136.525	30.162	29.769	22.225	143	189	2 600	3 500
	139.992	36.512	36.098	28.575	197	265	2 600	3 400
	150.089	44.450	46.672	36.512	289	360	2 400	3 200
82.550	125.412	25.400	25.400	19.845	113	163	2 700	3 600
	133.350	33.338	33.338	26.195	170	235	2 600	3 500
	133.350	39.688	39.688	32.545	196	305	2 600	3 500
	136.525	30.162	29.769	22.225	143	189	2 600	3 500
	139.992	36.512	36.098	28.575	197	265	2 600	3 400
	139.992	36.512	36.098	28.575	197	265	2 600	3 400
	146.050	41.275	41.275	31.750	228	295	2 500	3 300
	150.089	44.450	46.672	36.512	289	360	2 400	3 200
	152.400	39.688	36.322	30.162	199	279	2 300	3 100
	152.400	41.275	41.275	31.750	228	295	2 500	3 300
	161.925	47.625	48.260	38.100	299	385	2 300	3 100
	161.925	53.975	55.100	42.862	340	460	2 300	3 000
168.275	53.975	56.363	41.275	375	460	2 200	3 000	
83.345	125.412	25.400	25.400	19.845	113	163	2 700	3 600
	125.412	25.400	25.400	19.845	113	163	2 700	3 600
	125.412	25.400	25.400	19.845	113	163	2 700	3 600

Note: Chamfer dimensions on the back face of the inner and outer rings of the bearing are larger than the maximum values of installation-related dimensions r_{1a} and r_{1as} .
1) As for the maximum value for inner and outer ring diameters of bearings whose bearing numbers are marked with "†" (inner ring) and "††" (outer ring), the precision class is an integer for class 4 and class 2 bearings only.

Tapered Roller Bearings

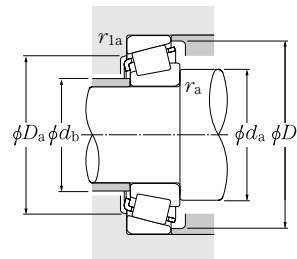

Dynamic equivalent radial load

$$P_r = X F_r + Y F_a$$

$\frac{F_a}{F_r} \leq e$		$\frac{F_a}{F_r} > e$	
X	Y	X	Y
1	0	0.4	Y_2

Static equivalent radial load

$$P_{0r} = 0.5 F_r + Y_0 F_a$$

When $P_{0r} < F_r$ use $P_{0r} = F_r$.

For values of e , Y_2 and Y_0 see the table below.

Bearing number 1) 2)	Installation-related dimensions						Load center ³⁾ mm	Constant e	Axial load factors		Mass kg (approx.)
	mm				r_{as} Max.	r_{1as} Max.			Y_2	Y_0	
	d_a	d_b	D_a	D_b			a				
4T-6461/6420	96	89	129	140	3.5	3.3	14.8	0.36	1.66	0.91	4.26
4T-6576/6535	99	92	141	154	3.5	3.3	12.8	0.40	1.50	0.82	5.43
4T-H917840/H917810††	110	100.1	152	170	3.5	3.3	-0.5	0.73	0.82	0.45	6.57
4T-HH221430/HH221410	101	95	171	179	3.5	3.3	14.4	0.33	1.79	0.99	8.71
4T-LM814849/LM814810	91	85	105	113	3.5	3.3	-2.3	0.51	1.18	0.65	0.929
4T-34306/34478	91	84	110	116	3.5	2	-1.2	0.45	1.33	0.73	0.94
4T-42690/42620	91	85	114	121	3.5	3.3	2.8	0.42	1.43	0.79	1.24
4T-495AS/493	93	87	122	130	3.5	3.3	0.7	0.44	1.35	0.74	1.78
4T-H715348/H715311	99	88	118	132	3.5	3.3	8.7	0.47	1.27	0.70	2.84
4T-661/653	96	90	131	139	3.5	3.3	8.0	0.41	1.47	0.81	2.92
4T-756A/752	109	94	144	150	8	3.3	12.0	0.34	1.76	0.97	4.55
4T-HH221431/HH221410	103	97	171	179	3.5	3.3	14.4	0.33	1.79	0.99	8.52
#4T-JM515649/JM515610	94	88	117	125	3	2.5	4.9	0.39	1.54	0.85	1.74
4T-47681/47620	95	89	119	128	3.5	3.3	3.9	0.40	1.48	0.82	1.78
4T-496/493	95	89	122	130	3.5	3.3	0.7	0.44	1.35	0.74	1.69
4T-581/572	96	90	125	133	3.5	3.3	5.5	0.40	1.49	0.82	2.25
4T-740/742	101	91	134	142	5	3.3	12.0	0.33	1.84	1.01	3.44
4T-27687/27620	96	89	115	120	3.5	1.5	-0.6	0.42	1.44	0.79	1.05
4T-47686/47620	98	92	119	128	3.5	3.3	3.9	0.40	1.48	0.82	1.72
4T-HM516448/HM516410	106	92	118	128	6.8	3.3	7.5	0.40	1.49	0.82	2.16
4T-495/493	97	90	122	130	3.5	3.3	0.7	0.44	1.35	0.74	1.64
4T-580/572	98	91	125	133	3.5	3.3	5.5	0.40	1.49	0.82	2.19
4T-582/572	104	91	125	133	6.8	3.3	5.5	0.40	1.49	0.82	2.18
4T-663/653	99	92	131	139	3.5	3.3	8.0	0.41	1.47	0.81	2.79
4T-749A/742	99	93	134	142	3.5	3.3	12.0	0.33	1.84	1.01	3.37
4T-595/592A	100	93	135	144	3.5	3.3	2.6	0.44	1.36	0.75	3.02
4T-663/652	99	92	134	141	3.5	3.3	8.0	0.41	1.47	0.81	3.16
4T-757/752	100	94	144	150	3.5	3.3	12.0	0.34	1.76	0.97	4.42
4T-6559C/6535	104	98	141	154	3.5	3.3	12.8	0.40	1.50	0.82	5.1
4T-842/832	101	94	149	155	3.5	3.3	18.5	0.30	2.00	1.10	5.47
4T-27689/27620	90	90	115	120	0.8	1.5	-0.6	0.42	1.44	0.79	1.06
4T-27690/27620	96	89	115	120	3.5	1.5	-0.6	0.42	1.44	0.79	1.03
4T-27691/27620	102	90	115	120	6.4	1.5	-0.6	0.42	1.44	0.79	1.04

2) Bearing numbers marked with "#" designate J-series bearings. The tolerance of these bearings is listed in Table 6.8 on page A-66 to A-67.
3) Dimensions with "-" indicate a load center at the outside on the end of an inner ring.

Tapered Roller Bearings



Inch series
J series

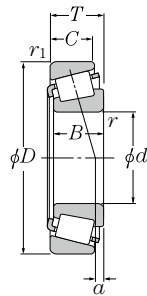

d 84.138 ~ 95.000mm

d	Boundary dimensions				Basic load rating		Allowable speed	
	mm				dynamic C _r kN	static C _{0r}	Grease lubrication min ⁻¹	Oil lubrication
	D	T	B	C				
84.138	136.525	30.162	29.769	22.225	143	189	2 600	3 500
85.000	130.000	30.000	29.000	24.000	149	214	2 600	3 500
	140.000	39.000	38.000	31.500	218	297	2 500	3 400
85.026	150.089	44.450	46.672	36.512	289	360	2 400	3 200
85.725	133.350	30.162	29.769	22.225	143	189	2 600	3 500
	142.138	42.862	42.862	34.133	240	350	2 500	3 300
	146.050	41.275	41.275	31.750	228	295	2 500	3 300
	152.400	39.688	36.322	30.162	199	279	2 300	3 100
	161.925	47.625	48.260	38.100	299	385	2 300	3 100
87.960	148.430	28.575	28.971	21.433	153	215	2 300	3 100
88.900	121.442	15.083	15.083	11.112	63.0	88.0	2 700	3 600
	123.825	20.638	20.638	16.670	89.0	141	2 700	3 500
	148.430	28.575	28.971	21.433	153	215	2 300	3 100
	152.400	39.688	36.322	30.162	199	279	2 300	3 100
	161.925	47.625	48.260	38.100	299	385	2 300	3 100
	161.925	53.975	55.100	42.862	340	460	2 300	3 000
168.275	53.975	56.363	41.275	375	460	2 200	3 000	
89.974	146.975	40.000	40.000	32.500	252	340	2 400	3 200
90.000	145.000	35.000	34.000	27.000	210	279	2 400	3 200
	155.000	44.000	44.000	35.500	299	385	2 300	3 100
	190.000	50.800	46.038	31.750	310	365	1 800	2 400
90.488	161.925	47.625	48.260	38.100	299	385	2 300	3 100
92.075	146.050	33.338	34.925	26.195	181	266	2 400	3 100
	152.400	39.688	36.322	30.162	199	279	2 300	3 100
	168.275	41.275	41.275	30.162	247	340	2 100	2 800
93.662	148.430	28.575	28.971	21.433	153	215	2 300	3 100
95.000	150.000	35.000	34.000	27.000	199	279	2 300	3 100

Note: Chamfer dimensions on the back face of the inner and outer rings of the bearing are larger than the maximum values of installation-related dimensions r_{1a} and r_{1as}.
1) As for the maximum value for inner and outer ring diameters of bearings whose bearing numbers are marked with "†" (inner ring) and "††" (outer ring), the precision class is an integer for class 4 and class 2 bearings only.
B-184

Tapered Roller Bearings

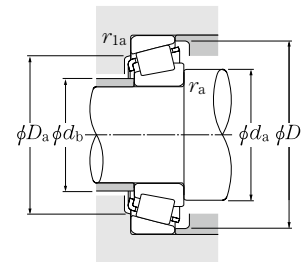

Dynamic equivalent radial load

$$P_r = X F_r + Y F_a$$

$\frac{F_a}{F_r} \leq e$		$\frac{F_a}{F_r} > e$	
X	Y	X	Y
1	0	0.4	Y ₂

Static equivalent radial load

$$P_{0r} = 0.5 F_r + Y_0 F_a$$

When $P_{0r} < F_r$ use $P_{0r} = F_r$.

For values of e, Y₂ and Y₀ see the table below.

Bearing number 1) 2)	Installation-related dimensions						Load center ³⁾ mm	Constant e	Axial load factors		Mass kg (approx.)	
	mm								a	Y ₂		Y ₀
	d _a	d _b	D _a	D _b	r _{as} Max.	r _{1as} Max.						
4T-498/493	98	91	122	130	3.5	3.3	0.7	0.44	1.35	0.74	1.6	
#4T-JM716648/JM716610	104	92	117	125	6	2.5	0.2	0.44	1.35	0.74	1.37	
#4T-JHM516849/JHM516810	100	94	125	134	3	2.5	5.9	0.41	1.47	0.81	2.3	
4T-749/742	101	95	134	142	3.5	3.3	12.0	0.33	1.84	1.01	3.24	
4T-497/492A	99	93	120	128	3.5	3.3	0.7	0.44	1.35	0.74	1.43	
4T-HM617049/HM617010	106	95.2	125	137	4.8	3.3	6.9	0.43	1.39	0.76	2.71	
4T-665/653	102	95	131	139	3.5	3.3	8.0	0.41	1.47	0.81	2.65	
4T-596/592A	102	96	135	144	3.5	3.3	2.6	0.44	1.36	0.75	2.9	
4T-758/752	106	100	144	150	3.5	3.3	12.0	0.34	1.76	0.97	4.26	
4T-42346/42584	103	98	134	142	3	3	-3.0	0.49	1.22	0.67	1.98	
4T-LL217849/LL217810	97	94	115	117	1.5	1.5	-2.9	0.33	1.81	1.00	0.452	
4T-L217849/L217810	97	94	116	119	1.5	1.5	-0.7	0.33	1.82	1.00	0.737	
4T-42350/42584	104	98	134	142	3	3	-3.0	0.49	1.22	0.67	1.95	
4T-593/592A	104	98	135	144	3.5	3.3	2.6	0.44	1.36	0.75	2.77	
4T-759/752	108	101	144	150	3.5	3.3	12.0	0.34	1.76	0.97	4.1	
4T-6580/6535	117	102	141	154	3.5	3.3	12.8	0.40	1.50	0.82	4.72	
4T-850/832	106	100	149	155	3.5	3.3	18.5	0.30	2.00	1.10	5.09	
4T-HM218248†/HM218210††	112	99	133	141	7	3.5	8.6	0.33	1.8	0.99	2.55	
#4T-JM718149/JM718110	106	99	131	138.8	3	2.5	2.0	0.44	1.35	0.74	2.14	
#4T-JHM318448/JHM318410	106	100	140	148	3	2.5	10.1	0.34	1.76	0.97	3.33	
#4T-J90354/J90748	120	111.8	162	179.3	3.5	3.3	-12.9	0.87	0.69	0.38	6.32	
4T-760/752	110	101	144	150	3.5	3.3	12.0	0.34	1.76	0.97	4.01	
4T-47890/47820	107	101	131	140	3.5	3.3	0.6	0.45	1.34	0.74	2.08	
4T-598A/592A	113	101	135	144	6.4	3.3	2.6	0.44	1.36	0.75	2.63	
4T-681/672	110	104	149	160	3.5	3.3	3.0	0.47	1.28	0.7	3.87	
4T-42368/42584	107	102	134	142	3	3	-3.0	0.49	1.22	0.67	1.8	
#4T-JM719149/JM719113	109	104	135	143	3	2.5	1.7	0.44	1.36	0.75	2.19	

2) Bearing numbers marked with "#" designate J-series bearings. The tolerance of these bearings is listed in Table 6.8 on page A-66 to A-67.
3) Dimensions with "-" indicate a load center at the outside on the end of an inner ring.
B-185

Tapered Roller Bearings



Inch series
J series

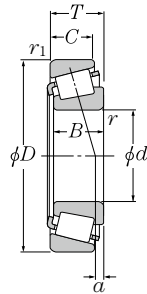

a 95.250 ~ 109.538mm

d	Boundary dimensions				Basic load rating		Allowable speed	
	mm				dynamic kN	static C _{0r}	Grease lubrication	Oil lubrication
	D	T	B	C				
95.250	130.175	20.638	21.433	16.670	90.0	147	2 500	3 300
	146.050	33.338	34.925	26.195	181	266	2 400	3 100
	147.638	35.717	36.322	26.192	199	279	2 300	3 100
	148.430	28.575	28.971	21.433	153	215	2 300	3 100
	152.400	39.688	36.322	30.162	199	279	2 300	3 100
	157.162	36.512	36.116	26.195	208	305	2 200	2 900
	168.275	41.275	41.275	30.162	247	340	2 100	2 800
190.500	57.150	57.531	46.038	490	610	1 900	2 600	
96.838	148.430	28.575	28.971	21.433	153	215	2 300	3 100
	188.912	50.800	46.038	31.750	310	365	1 800	2 400
98.425	157.162	36.512	36.116	26.195	208	305	2 200	2 900
	168.275	41.275	41.275	30.162	247	340	2 100	2 800
99.974	212.725	66.675	66.675	53.975	635	810	1 700	2 300
100.000	155.000	36.000	35.000	28.000	213	310	2 200	2 900
100.012	157.162	36.512	36.116	26.195	208	305	2 200	2 900
101.600	157.162	36.512	36.116	26.195	208	305	2 200	2 900
	168.275	41.275	41.275	30.162	247	340	2 100	2 800
	180.975	47.625	48.006	38.100	315	430	2 000	2 700
	190.500	57.150	57.531	44.450	420	555	2 000	2 600
	190.500	57.150	57.531	46.038	490	610	1 900	2 600
	190.500	57.150	57.531	46.038	490	610	1 900	2 600
	212.725	66.675	66.675	53.975	525	695	1 800	2 300
212.725	66.675	66.675	53.975	635	810	1 700	2 300	
104.775	180.975	47.625	48.006	38.100	315	430	2 000	2 700
107.950	158.750	23.020	21.438	15.875	114	166	2 100	2 800
	159.987	34.925	34.925	26.988	186	320	2 100	2 800
	165.100	36.512	36.512	26.988	212	315	2 100	2 700
	212.725	66.675	66.675	53.975	525	695	1 800	2 300
109.538	158.750	23.020	21.438	15.875	114	166	2 100	2 800

Note: Chamfer dimensions on the back face of the inner and outer rings of the bearing are larger than the maximum values of installation-related dimensions r_{1a} and r_{1as} .
1) As for the maximum value for inner and outer ring diameters of bearings whose bearing numbers are marked with "†" (inner ring) and "††" (outer ring), the precision class is an integer for class 4 and class 2 bearings only. B-186

Tapered Roller Bearings

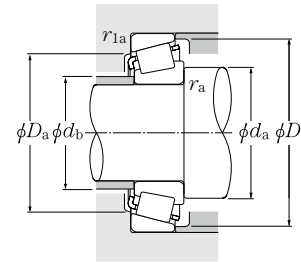

Dynamic equivalent radial load

$$P_r = X F_r + Y F_a$$

$\frac{F_a}{F_r} \leq e$		$\frac{F_a}{F_r} > e$	
X	Y	X	Y
1	0	0.4	Y_2

Static equivalent radial load

$$P_{0r} = 0.5 F_r + Y_0 F_a$$

When $P_{0r} < F_r$ use $P_{0r} = F_r$.

For values of e , Y_2 and Y_0 see the table below.

Bearing number 1) 2)	Installation-related dimensions						Load center ³⁾ mm	Constant e	Axial load factors		Mass kg (approx.)
	mm								Y_2	Y_0	
	d_a	d_b	D_a	D_b	r_{as} Max.	r_{1as} Max.	a	e	Y_2	Y_0	
4T-L319249/L319210	103	101	122	125	1.5	1.5	-1.0	0.35	1.72	0.95	0.786
4T-47896/47820	110	103	131	140	3.5	3.3	0.6	0.45	1.34	0.74	1.95
4T-594A/592XE	113	104	135	142	5	0.8	2.6	0.44	1.36	0.75	2.09
4T-42375/42584	108	103	134	142	3	3	-3.0	0.49	1.22	0.67	1.74
4T-594/592A	110	104	135	144	3.5	3.3	2.6	0.44	1.36	0.75	2.51
4T-52375/52618	112	105	142	152	3.5	3.3	0.6	0.47	1.26	0.69	2.76
4T-683/672	113	106	149	160	3.5	3.3	3.0	0.47	1.28	0.70	3.72
4T-HH221440/HH221410	125	110	171	179	8	3.3	14.4	0.33	1.79	0.99	7.5
4T-42381/42584	112	105	134	142	3.5	3	-3.0	0.49	1.22	0.67	1.69
4T-90381/90744	125	113	161	179	3.5	3.3	-12.9	0.87	0.69	0.38	5.46
4T-52387/52618	114	108	142	152	3.5	3.3	0.6	0.47	1.26	0.69	2.62
4T-685/672	116	109	149	160	3.5	3.3	3.0	0.47	1.28	0.70	3.57
4T-HH224334†/HH224310	124	120	192	201.7	3.5	3.3	18.9	0.33	1.84	1.01	11.5
#4T-JM720249/JM720210	115	109	140	149	3	2.5	-0.3	0.47	1.27	0.70	2.4
4T-52393/52618	116	109	142	152	3.5	3.3	0.6	0.47	1.26	0.69	2.55
4T-52400/52618	117	111	142	152	3.5	3.3	0.6	0.47	1.26	0.69	2.48
4T-687/672	118	112	149	160	3.5	3.3	3.0	0.47	1.28	0.70	3.4
4T-780/772††	119	113	161	168	3.5	3.3	8.1	0.39	1.56	0.86	5.12
4T-861/854	129	114	170	174	8	3.3	15.3	0.33	1.79	0.99	7
4T-HH221449/HH221410	131	115.9	171	179	8	3.3	14.4	0.33	1.79	0.99	7.07
4T-HH221449A/HH221410	122	115.9	171	179	3.5	3.3	14.4	0.33	1.79	0.99	7.06
4T-941/932	130	117	187	193.1	7	3.3	19.7	0.33	1.84	1.01	11.2
4T-HH224335/HH224310	132	121	192	201.7	7	3.3	18.9	0.33	1.84	1.01	11.3
4T-782/772††	122	116	161	168	3.5	3.3	8.1	0.39	1.56	0.86	4.92
4T-37425/37625	122	115	143	152	3.5	3.3	-14.0	0.61	0.99	0.54	1.37
4T-LM522546/LM522510	122	116	146	154	3.5	3.3	1.4	0.40	1.49	0.82	2.37
4T-56425/56650	123	117	149	159	3.5	3.3	-2.0	0.50	1.21	0.66	2.69
4T-936/932	137	122	187	193.1	8	3.3	19.7	0.33	1.84	1.01	10.7
4T-37431/37625	123	116	143	152	3.5	3.3	-14	0.61	0.99	0.54	1.32

2) Bearing numbers marked with "#" designate J-series bearings. The tolerance of these bearings is listed in Table 6.8 on page A-66 to A-67.
3) Dimensions with "-" indicate a load center at the outside on the end of an inner ring. B-187

Tapered Roller Bearings



Inch series
J series

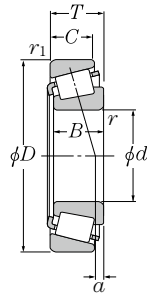

a 109.987 ~ 133.350mm

	Boundary dimensions				Basic load rating		Allowable speed	
	mm				dynamic	static	Grease	Oil
d	D	T	B	C	C _r	C _{0r}	lubrication	lubrication
109.987	159.987	34.925	34.925	26.988	186	320	2 100	2 800
109.992	177.800	41.275	41.275	30.162	257	375	1 900	2 600
110.000	165.000	35.000	35.000	26.500	212	315	2 100	2 700
	180.000	47.000	46.000	38.000	340	480	1 900	2 600
111.125	214.312	55.562	52.388	39.688	450	560	1 500	2 000
114.300	177.800	41.275	41.275	30.162	257	375	1 900	2 600
	180.975	34.925	31.750	25.400	187	245	1 900	2 500
	212.725	66.675	66.675	53.975	525	695	1 800	2 300
	212.725	66.675	66.675	53.975	635	810	1 700	2 300
	228.600	53.975	49.428	38.100	475	620	1 400	1 900
115.087	190.500	47.625	49.212	34.925	335	475	1 800	2 500
117.475	180.975	34.925	31.750	25.400	187	245	1 900	2 500
120.000	170.000	25.400	25.400	19.050	141	210	2 000	2 600
120.650	234.950	63.500	63.500	49.212	580	825	1 500	2 000
123.825	182.562	39.688	38.100	33.338	249	435	1 800	2 400
	182.562	39.688	38.100	33.338	249	435	1 800	2 400
127.000	196.850	46.038	46.038	38.100	340	550	1 700	2 200
	215.900	47.625	47.625	34.925	355	540	1 600	2 100
	228.600	53.975	49.428	38.100	355	445	1 400	1 900
	228.600	53.975	49.428	38.100	475	620	1 400	1 900
	230.000	63.500	63.500	49.212	580	825	1 500	2 000
	254.000	77.788	82.550	61.912	820	1 070	1 400	1 900
128.588	206.375	47.625	47.625	34.925	350	520	1 700	2 200
130.175	196.850	46.038	46.038	38.100	340	550	1 700	2 200
	206.375	47.625	47.625	34.925	350	520	1 700	2 200
133.350	177.008	25.400	26.195	20.638	140	259	1 800	2 400

Note: Chamfer dimensions on the back face of the inner and outer rings of the bearing are larger than the maximum values of installation-related dimensions r_{1a} and r_{1as} .
1) As for the maximum value for inner and outer ring diameters of bearings whose bearing numbers are marked with "†" (inner ring) and "††" (outer ring), the precision class is an integer for class 4 and class 2 bearings only. B-188

Tapered Roller Bearings

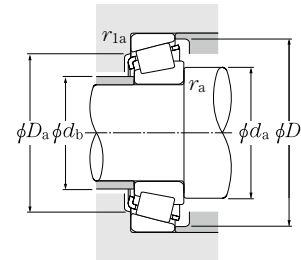

Dynamic equivalent radial load

$$P_r = X F_r + Y F_a$$

$\frac{F_a}{F_r} \leq e$		$\frac{F_a}{F_r} > e$	
X	Y	X	Y
1	0	0.4	Y_2

Static equivalent radial load

$$P_{0r} = 0.5 F_r + Y_0 F_a$$

When $P_{0r} < F_r$ use $P_{0r} = F_r$.

For values of e , Y_2 and Y_0 see the table below.

Bearing number 1) 2)	Installation-related dimensions						Load center ³⁾	Constant	Axial		Mass
	mm								mm	load factors	
	d_a	d_b	D_a	D_b	r_{as} Max.	r_{1as} Max.	a	e	Y_2	Y_0	(approx.)
4T-LM522548/LM522510	133	118	146	154	8	3.3	1.4	0.40	1.49	0.82	2.24
4T-64433/64700	128	121	160	172	3.5	3.3	-1.1	0.52	1.16	0.64	3.77
#4T-JM822049/JM822010	125	119	149	159	3	2.5	-3.0	0.50	1.21	0.66	2.52
#4T-JHM522649/JHM522610	127	122	162	172	3	2.5	6.0	0.41	1.48	0.81	4.61
4T-H924045/H924010	139	131.2	186	205	3.5	3.3	-6.8	0.67	0.89	0.49	8.47
4T-64450/64700	131	125	160	172	3.5	3.3	-1.1	0.52	1.16	0.64	3.52
4T-68450/68712††	130	123	163	172	3.5	3.3	-5.4	0.50	1.21	0.66	2.93
4T-938/932	141	128	187	193.1	7	3.3	19.7	0.33	1.84	1.01	10.1
4T-HH224346/HH224310	143	131	192	201.7	7	3.3	18.9	0.33	1.84	1.01	10.1
4T-HM926740/HM926710	146	142	200	219.3	3.5	3.3	-13.5	0.74	0.81	0.45	9.76
4T-71453/71750	133	126	171	181	3.5	3.3	6.7	0.42	1.44	0.79	5.11
4T-68462/68712††	132	125	163	172	3.5	3.3	-5.4	0.50	1.21	0.66	2.78
#4T-JL724348/JL724314	132	127	156	163	3.3	3.3	-7.9	0.46	1.31	0.72	1.67
4T-95475/95925	149	137	209	217	6.4	3.3	14.0	0.37	1.62	0.89	12.6
4T-48286/48220	139	133	168	176	3.5	3.3	5.7	0.31	1.97	1.08	3.52
4T-48290/48220	141	135	168	176	3.5	3.3	5.7	0.31	1.97	1.08	3.33
4T-67388/67322	144	138	180	189	3.5	3.3	6.3	0.34	1.74	0.96	5.1
4T-74500/74850	148	141	196	208	3.5	3.3	-2.2	0.49	1.23	0.68	7.04
4T-97500/97900	151	144	197	213	3.5	3.3	-13.4	0.74	0.81	0.45	8.43
4T-HM926747/HM926710	156	143	200	219.3	3.5	3.3	-13.5	0.74	0.81	0.45	8.83
4T-95500/95905	154	142	207	217	6.4	3.3	14.0	0.37	1.62	0.89	12.9
4T-HH228349/HH228310	164	148	223	233.6	9.7	6.4	23.4	0.32	1.87	1.03	18
4T-799/792	146	140	186	196	3.3	3.3	1.9	0.46	1.31	0.72	5.77
4T-67389/67322	147	141	180	189	3.5	3.3	6.3	0.34	1.74	0.96	4.87
4T-799A/792	148	142	186	196	3.5	3.3	1.9	0.46	1.31	0.72	5.65
4T-L327249/L327210	142	140	167	171	1.5	1.5	-3.7	0.35	1.72	0.95	1.7

2) Bearing numbers marked with "#" designate J-series bearings. The tolerance of these bearings is listed in Table 6.8 on page A-66 to A-67.
3) Dimensions with "-" indicate a load center at the outside on the end of an inner ring. B-189

Inch series
J series

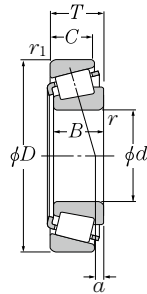

a 133.350 ~ 196.850mm

d	Boundary dimensions				Basic load rating		Allowable speed	
	mm				dynamic C _r kN	static C _{0r}	Grease lubrication min ⁻¹	Oil lubrication
	D	T	B	C				
133.350	190.500	39.688	39.688	33.338	262	475	1 700	2 300
	196.850	46.038	46.038	38.100	340	550	1 700	2 200
	196.850	46.038	46.038	38.100	340	550	1 700	2 200
	215.900	47.625	47.625	34.925	355	540	1 600	2 100
	234.950	63.500	63.500	49.212	580	825	1 500	2 000
136.525	190.500	39.688	39.688	33.338	262	475	1 700	2 300
	228.600	57.150	57.150	44.450	495	735	1 500	2 000
139.700	215.900	47.625	47.625	34.925	355	540	1 600	2 100
	228.600	57.150	57.150	44.450	495	735	1 500	2 000
	254.000	66.675	66.675	47.625	610	910	1 400	1 800
142.875	200.025	41.275	39.688	34.130	265	490	1 600	2 100
	200.025	41.275	39.688	34.130	265	490	1 600	2 100
146.050	193.675	28.575	28.575	23.020	183	340	1 600	2 200
	254.000	66.675	66.675	47.625	610	910	1 400	1 800
152.400	192.088	25.000	24.000	19.000	144	261	1 600	2 100
	222.250	46.830	46.830	34.925	350	585	1 500	2 000
158.750	205.583	23.812	23.812	18.258	140	247	1 500	2 000
	225.425	41.275	39.688	33.338	282	555	1 400	1 900
165.100	225.425	41.275	39.688	33.338	282	555	1 400	1 900
170.000	230.000	39.000	38.000	31.000	310	520	1 400	1 800
177.800	227.012	30.162	30.162	23.020	201	415	1 300	1 800
	247.650	47.625	47.625	38.100	380	690	1 300	1 700
180.000	250.000	47.000	45.000	37.000	410	710	1 300	1 700
190.000	260.000	46.000	44.000	36.500	405	720	1 200	1 600
196.850	241.300	23.812	23.017	17.462	177	330	1 200	1 600

Note: Chamfer dimensions on the back face of the inner and outer rings of the bearing are larger than the maximum values of installation-related dimensions r_{as} and r_{1as} .

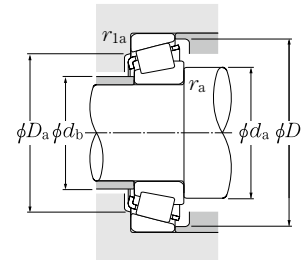

Dynamic equivalent radial load

$$P_r = X F_r + Y F_a$$

$\frac{F_a}{F_r} \leq e$		$\frac{F_a}{F_r} > e$	
X	Y	X	Y
1	0	0.4	Y_2

Static equivalent radial load

$$P_{0r} = 0.5 F_r + Y_0 F_a$$

When $P_{0r} < F_r$ use $P_{0r} = F_r$.

For values of e , Y_2 and Y_0 see the table below.

Bearing number ¹⁾	Installation-related dimensions						Load center ²⁾ mm	Constant e	Axial load factors		Mass kg (approx.)
	mm								Y ₂	Y ₀	
	da	db	Da	D _b	r _{as} Max.	r _{1as} Max.					
4T-48385/48320	148	142	177	184	3.5	3.3	4.0	0.32	1.87	1.03	3.64
4T-67390/67322	150	144	180	189	3.5	3.3	6.3	0.34	1.74	0.96	4.63
4T-67391/67322	157	143	180	189	8	3.3	6.3	0.34	1.74	0.96	4.59
4T-74525/74850	152	146	196	208	3.5	3.3	-2.2	0.49	1.23	0.68	6.56
4T-95525/95925	166	148	209	217	9.7	3.3	14.0	0.37	1.62	0.89	11.3
4T-48393/48320	151	144	177	184	3.5	3.3	4.0	0.32	1.87	1.03	3.43
4T-896/892	156	150	205	216	3.5	3.3	6.0	0.42	1.43	0.78	9.12
4T-74550/74850	158	151	196	208	3.5	3.3	-2.2	0.49	1.23	0.68	6.05
4T-898/892	160	153	205	216	3.5	3.3	6.0	0.42	1.43	0.78	8.81
4T-99550/99100	170	156	227	238	7	3.3	12.1	0.41	1.47	0.81	14.3
4T-48684/48620	166	151	185	193	8	3.3	3.1	0.34	1.78	0.98	3.85
4T-48685/48620	158	151	185	193	3.5	3.3	3.1	0.34	1.78	0.98	3.89
4T-36690/36620	155	153	182	188	1.5	1.5	-5.0	0.37	1.63	0.90	2.26
4T-99575/99100	175	162	227	238	7	3.3	12.1	0.41	1.47	0.81	13.6
4T-L630349/L630310	162	158	183	187	2	2	-10.0	0.42	1.44	0.79	1.57
4T-M231648/M231610	178	163	207	213	8	1.5	5.9	0.33	1.80	0.99	5.7
4T-L432349/L432310	168	166	195	199	1.5	1.5	-9.8	0.37	1.61	0.88	1.89
4T-46780/46720	176	169	209	218	3.5	3.3	-2.6	0.38	1.57	0.86	5.19
4T-46790/46720	181	174	209	218	3.5	3.3	-2.6	0.38	1.57	0.86	4.68
#4T-JHM534149/JHM534110	184	178	217	224	3	2.5	-4.7	0.38	1.57	0.86	4.37
4T-36990/36920	188	186	214	221	1.5	1.5	-12.8	0.44	1.36	0.75	2.91
4T-67790/67720	194	188	229	240	3.5	3.3	-4.8	0.44	1.36	0.75	6.72
#4T-JM736149/JM736110	196	190.5	232	242.6	3	2.5	-9.0	0.48	1.25	0.69	6.74
#4T-JM738249/JM738210	206	200	242	252	3	2.5	-10.9	0.48	1.26	0.69	6.84
4T-LL639249/LL639210	205	203	232	236	1.5	1.5	-17.3	0.42	1.44	0.79	2.07

1) Bearing numbers marked "#" designate J-series bearings. The tolerance of these bearings is listed in Table 6.8 on page A-66 to A-67.
2) Dimensions with "-" indicate a load center at the outside on the end of an inner ring.

● Double Row Tapered Roller Bearings



Back-to-back arrangement

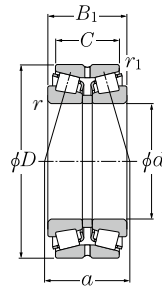

d 40 ~ 70mm

d	Boundary dimensions					Basic load rating		Fatigue load limit kN C _u	Allowable speed	
	D	B ₁	C	r _{s min} ¹⁾	r _{1s min} ¹⁾	dynamic C _R	static C _{0R}		Grease lubrication	Oil lubrication
40	80	45	37.5	1.5	0.6	116	134	—	4 100	5 500
	80	55	43.5	1.5	0.6	151	187	—	4 100	5 500
	90	56	39.5	2	0.6	147	171	—	3 200	4 200
	90	56	45.5	2	0.6	174	204	—	3 700	4 900
45	85	47	37.5	1.5	0.6	129	157	—	3 700	4 900
	85	55	43.5	1.5	0.6	156	200	—	3 700	4 900
	100	60	41.5	2	0.6	183	218	—	2 800	3 800
	100	60	49.5	2	0.6	212	251	—	3 300	4 400
50	90	49	39.5	1.5	0.6	147	186	—	3 400	4 500
	90	55	43.5	1.5	0.6	166	218	26.6	3 400	4 500
	110	64	43.5	2.5	0.6	216	260	—	2 600	3 500
	110	64	51.5	2.5	0.6	252	305	—	3 000	4 000
110	90	71.5	2.5	0.6	350	465	56.5	3 000	4 000	
55	100	51	41.5	2	0.6	177	221	—	3 100	4 100
	100	60	48.5	2	0.6	206	269	33.0	3 100	4 100
	120	70	49	2.5	0.6	251	305	—	2 400	3 100
	120	70	57	2.5	0.6	295	360	43.5	2 700	3 700
120	97	76	2.5	0.6	410	550	67.0	2 700	3 700	
60	110	53	43.5	2	0.6	199	249	—	2 800	3 800
	110	66	54.5	2	0.6	247	330	40.0	2 800	3 800
	130	74	51	3	1	286	350	—	2 200	2 900
	130	74	59	3	1	340	420	51.0	2 500	3 400
130	104	81	3	1	465	625	76.5	2 500	3 400	
65	120	56	46.5	2	0.6	234	295	—	2 600	3 500
	120	73	61.5	2	0.6	300	410	50.0	2 600	3 500
	140	79	53	3	1	330	410	—	2 000	2 700
	140	79	63	3	1	385	475	57.5	2 300	3 100
140	108	84	3	1	520	700	85.0	2 300	3 100	
70	125	59	48.5	2	0.6	250	325	—	2 400	3 200
	125	74	61.5	2	0.6	315	440	53.5	2 400	3 200
	150	83	57	3	1	365	460	—	1 900	2 500
	150	83	67	3	1	435	545	64.0	2 200	2 900
150	116	92	3	1	590	805	95.5	2 200	2 900	

1) Smallest allowable dimension for chamfer dimension r or r₁.

● Double Row Tapered Roller Bearings

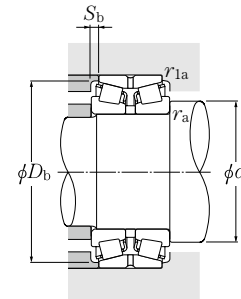

Dynamic equivalent radial load

$$P_r = X F_r + Y F_a$$

$\frac{F_a}{F_r} \leq e$		$\frac{F_a}{F_r} > e$	
X	Y	X	Y
1	Y ₁	0.67	Y ₂

Static equivalent radial load

$$P_{0r} = F_r + Y_0 F_a$$

For values of e, Y₁, Y₂ and Y₀ see the table below.

Bearing number	Abutment and fillet dimensions					Load center mm a	Constant e	Axial load factors			Mass kg (approx.)
	d _a Min.	D _b Min.	mm S _b Min.	r _{as} Max.	r _{1as} Max.			Y ₁	Y ₂	Y ₀	
4T-430208X	48.5	75	3.5	1.5	0.6	38.5	0.37	1.80	2.68	1.76	0.956
4T-432208X	48.5	75	5.5	1.5	0.6	43.5	0.37	1.80	2.68	1.76	1.18
4T-430308DX	50	86.5	8	2	0.6	64.5	0.83	0.82	1.22	0.80	1.59
4T-430308	50	83.5	5	2	0.6	44.5	0.35	1.96	2.91	1.91	1.7
4T-430209	53.5	80	4.5	1.5	0.6	42	0.40	1.67	2.48	1.63	1.08
4T-432209	53.5	81	5.5	1.5	0.6	46	0.40	1.67	2.48	1.63	1.27
4T-430309DX	55	96.5	9	2	0.6	70	0.83	0.82	1.22	0.80	2.11
4T-430309	55	93.5	5	2	0.6	47.5	0.35	1.96	2.91	1.91	2.17
4T-430210	58.5	85	4.5	1.5	0.6	45	0.42	1.61	2.39	1.57	1.23
432210U	58.5	86	5.5	1.5	0.6	47.5	0.42	1.61	2.39	1.57	1.4
4T-430310DX	62	104.5	10	2	0.6	75	0.83	0.82	1.22	0.80	2.7
4T-430310	62	103	6	2	0.6	51	0.35	1.96	2.91	1.91	2.81
432310U	62	102.5	9	2	0.6	62.5	0.35	1.96	2.91	1.91	3.98
4T-430211X	65	95	4.5	2	0.6	47.5	0.40	1.67	2.48	1.63	1.57
432211U	65	96	5.5	2	0.6	47.5	0.40	1.67	2.48	1.63	1.89
4T-430311DX	67	113.5	10.5	2	0.6	83	0.83	0.82	1.22	0.80	3.42
430311XU	67	112.5	6.5	2	0.6	56	0.35	1.96	2.91	1.91	3.57
432311U	67	111.5	10.5	2	0.6	66.5	0.35	1.96	2.91	1.91	5.05
4T-430212X	70	104	4.5	2	0.6	49.5	0.40	1.67	2.48	1.63	1.99
432212U	70	105	5.5	2	0.6	56	0.40	1.67	2.48	1.63	2.49
4T-430312DX	74	124	11.5	2.5	1	88.5	0.83	0.82	1.22	0.80	4.3
430312U	74	122	7.5	2.5	1	60	0.35	1.96	2.91	1.91	4.31
432312U	74	121.5	11.5	2.5	1	71	0.35	1.96	2.91	1.91	6.39
4T-430213X	75	114.5	4.5	2	0.6	54	0.40	1.67	2.48	1.63	2.56
432213U	75	115.5	5.5	2	0.6	62	0.40	1.67	2.48	1.63	3.41
4T-430313DX	79	133.5	13	2.5	1	94.5	0.83	0.82	1.22	0.80	5.26
430313XU	79	131.5	8	2.5	1	64	0.35	1.96	2.91	1.91	5.41
432313U	79	131.5	12	2.5	1	74.5	0.35	1.96	2.91	1.91	7.55
4T-430214	80	119	5	2	0.6	57.5	0.42	1.61	2.39	1.57	2.83
432214U	80	120.5	6	2	0.6	65	0.42	1.61	2.39	1.57	3.65
4T-430314DX	84	142.5	13	2.5	1	101.5	0.83	0.82	1.22	0.80	6.32
430314XU	84	141	8	2.5	1	67	0.35	1.96	2.91	1.91	6.53
432314U	84	141	12	2.5	1	80.5	0.35	1.96	2.91	1.91	9.28

Double Row Tapered Roller Bearings



Back-to-back arrangement

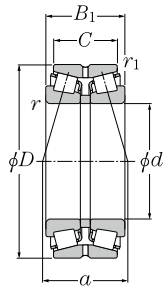

a 75 ~ 105mm

d	Boundary dimensions					Basic load rating		Fatigue load limit kN C _u	Allowable speed	
	D	B ₁	C	r _{s min} ¹⁾	r _{1s min} ¹⁾	dynamic	static		Grease	Oil
	mm	mm	mm	mm	mm	C _r	C _{0r}		lubrication	lubrication
75	130	62	51.5	2	0.6	264	350	—	2 300	3 000
	130	74	61.5	2	0.6	320	445	54.0	2 300	3 000
	160	87	59	3	1	410	510	59.5	1 700	2 300
	160	87	69	3	1	485	605	70.0	2 000	2 700
	160	125	99	3	1	675	935	109	2 000	2 700
80	140	64	51.5	2.5	0.6	305	400	47.5	2 100	2 800
	140	78	63.5	2.5	0.6	380	530	63.0	2 100	2 800
	170	92	61	3	1	450	565	64.5	1 600	2 200
	170	92	73	3	1	555	700	79.5	1 900	2 500
	170	131	104	3	1	755	1 050	120	1 900	2 500
85	150	70	57	2.5	0.6	345	465	54.0	2 000	2 700
	150	86	69	2.5	0.6	425	600	70.0	2 000	2 700
	180	98	65	4	1	470	585	66.0	1 500	2 100
	180	98	77	4	1	580	725	81.0	1 800	2 400
	180	137	108	4	1	765	1 050	118	1 800	2 400
90	160	74	61	2.5	0.6	395	535	61.0	1 900	2 500
	160	94	77	2.5	0.6	500	720	82.5	1 900	2 500
	190	102	69	4	1	515	645	71.0	1 500	1 900
	190	102	81	4	1	640	815	89.0	1 700	2 300
	190	144	115	4	1	855	1 190	131	1 700	2 300
95	170	78	63	3	1	430	580	65.0	1 800	2 400
	170	100	83	3	1	570	835	93.5	1 800	2 400
	200	108	85	4	1	700	890	96.5	1 600	2 100
	200	151	118	4	1	955	1 340	146	1 600	2 100
	100	180	83	67	3	1	490	675	74.5	1 700
180		107	87	3	1	630	925	102	1 700	2 200
215		112	87	4	1	780	995	106	1 500	2 000
215		162	127	4	1	1 090	1 540	164	1 500	2 000
105		190	88	70	3	1	545	760	82.5	1 600
	190	115	95	3	1	720	1 080	118	1 600	2 100

1) Smallest allowable dimension for chamfer dimension r or r₁.

Double Row Tapered Roller Bearings

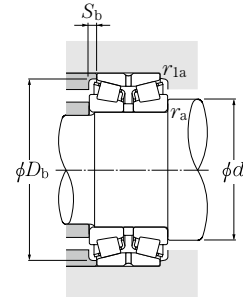

Dynamic equivalent radial load

$$P_r = X F_r + Y F_a$$

$\frac{F_a}{F_r} \leq e$		$\frac{F_a}{F_r} > e$	
X	Y	X	Y
1	Y ₁	0.67	Y ₂

Static equivalent radial load

$$P_{0r} = F_r + Y_0 F_a$$

For values of e, Y₁, Y₂ and Y₀ see the table below.

Bearing number	Abutment and fillet dimensions					Load center mm a	Constant e	Axial load factors			Mass kg (approx.)
	d _a Min.	D _b Min.	mm S _b Min.	r _{as} Max.	r _{1as} Max.			Y ₁	Y ₂	Y ₀	
4T-430215	85	125	5	2	0.6	61.5	0.44	1.55	2.31	1.52	3.1
432215U	85	125.5	6	2	0.6	67	0.44	1.55	2.31	1.52	3.68
430315DU	89	152.5	14	2.5	1	107	0.83	0.82	1.22	0.80	7.31
430315XU	89	150.5	9	2.5	1	70.5	0.35	1.96	2.91	1.91	7.71
432315U	89	150.5	13	2.5	1	87.5	0.35	1.96	2.91	1.91	11.5
430216XU	92	133	6	2	0.6	63	0.42	1.61	2.39	1.57	3.76
432216XU	92	135	7	2	0.6	69.5	0.42	1.61	2.39	1.57	4.7
430316DU	94	160.5	15.5	2.5	1	113.5	0.83	0.82	1.22	0.80	8.99
430316XU	94	160	9.5	2.5	1	75.5	0.35	1.96	2.91	1.91	9.4
432316U	94	161.5	13.5	2.5	1	91	0.35	1.96	2.91	1.91	13.6
430217XU	97	141.5	6.5	2	0.6	69	0.42	1.61	2.39	1.57	4.76
432217XU	97	143.5	8.5	2	0.6	76.5	0.42	1.61	2.39	1.57	5.99
430317DU	103	170	16.5	3	1	121.5	0.83	0.82	1.22	0.80	10.4
430317XU	103	168	10.5	3	1	80	0.35	1.96	2.91	1.91	10.8
432317U	103	169	14.5	3	1	96	0.35	1.96	2.91	1.91	15.4
430218U	102	151	6.5	2	0.6	73	0.42	1.61	2.39	1.57	5.85
432218U	102	153.5	8.5	2	0.6	81	0.42	1.61	2.39	1.57	7.35
430318DU	108	180.5	16.5	3	1	127	0.83	0.82	1.22	0.80	12.2
430318U	108	177.5	10.5	3	1	84	0.35	1.96	2.91	1.91	12.5
432318U	108	179	14.5	3	1	100	0.35	1.96	2.91	1.91	18.3
430219XU	109	160.5	7.5	2.5	1	76.5	0.42	1.61	2.39	1.57	6.85
432219XU	109	163	8.5	2.5	1	86.5	0.42	1.61	2.39	1.57	9.2
430319XU	113	185.5	11.5	3	1	89	0.35	1.96	2.91	1.91	14.6
432319U	113	187.5	16.5	3	1	106	0.35	1.96	2.91	1.91	21
430220XU	114	169.5	8	2.5	1	81.5	0.42	1.61	2.39	1.57	8.27
432220XU	114	172	10	2.5	1	92	0.42	1.61	2.39	1.57	11
430320XU	118	198.5	12.5	3	1	92	0.35	1.96	2.91	1.91	17.9
432320U	118	201.5	17.5	3	1	112.5	0.35	1.96	2.91	1.91	26.8
430221XU	119	178.5	9	2.5	1	86	0.42	1.61	2.39	1.57	9.8
432221XU	119	181.5	10	2.5	1	97.5	0.42	1.61	2.39	1.57	13.3

Double Row Tapered Roller Bearings



Back-to-back arrangement

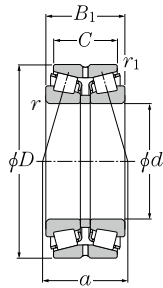

d 110 ~ 150mm

d	Boundary dimensions					Basic load rating		Fatigue load limit kN C _u	Allowable speed	
	D	B ₁	C	r _{s min} ¹⁾	r _{1s min} ¹⁾	dynamic	static		min ⁻¹	Oil
	mm	mm	mm	mm	mm	C _r	C _{0r}		Grease lubrication	lubrication
110	180	56	50	2.5	0.6	253	340	37.5	1 600	2 200
	180	70	56	2.5	0.6	330	485	53.0	1 600	2 200
	200	92	74	3	1	615	865	92.5	1 500	2 000
	200	121	101	3	1	800	1 210	130	1 500	2 000
	240	118	93	4	1	910	1 170	120	1 400	1 800
240	181	142	4	1	1 340	1 940	199	1 400	1 800	
120	180	46	41	2.5	0.6	214	298	32.0	1 500	2 100
	180	58	46	2.5	0.6	255	375	40.0	1 500	2 100
	200	62	55	2.5	0.6	291	435	46.0	1 500	2 000
	200	78	62	2.5	0.6	415	610	64.5	1 500	2 000
	215	97	78	3	1	660	940	98.5	1 400	1 900
	215	132	109	3	1	875	1 360	143	1 400	1 900
	260	128	101	4	1	1 060	1 390	139	1 200	1 700
260	188	145	4	1	1 550	2 270	228	1 200	1 700	
130	200	52	46	2.5	0.6	249	365	38.5	1 400	1 900
	200	65	52	2.5	0.6	325	490	51.5	1 400	1 900
	210	64	57	2.5	0.6	350	485	50.5	1 400	1 800
	210	80	64	2.5	0.6	455	675	70.5	1 400	1 800
	230	98	78.5	4	1	710	1 010	103	1 300	1 700
	230	145	117.5	4	1	1 010	1 630	167	1 300	1 700
	280	137	107.5	5	1.5	1 430	1 660	162	1 200	1 600
280	205	163.5	4	1.5	1 960	2 470	243	1 200	1 600	
140	210	53	47	2.5	0.6	291	415	43.0	1 300	1 800
	210	66	53	2.5	0.6	335	535	55.0	1 300	1 800
	225	68	61	3	1	410	580	59.0	1 200	1 700
	225	84	68	3	1	435	650	66.0	1 200	1 700
	250	102	82.5	4	1	800	1 140	114	1 200	1 600
	250	153	125.5	4	1	1 160	1 840	184	1 200	1 600
	300	145	115.5	5	1.5	1 620	1 900	183	1 100	1 500
	300	223	177.5	4	1.5	2 170	2 740	264	1 100	1 500
150	225	56	50	3	1	305	430	43.5	1 200	1 600
	225	70	56	3	1	395	630	64.0	1 200	1 600
	250	80	71	3	1	540	805	79.5	1 200	1 500
	250	100	80	3	1	670	1 040	103	1 200	1 500

1) Smallest allowable dimension for chamfer dimension r or r₁.

Double Row Tapered Roller Bearings

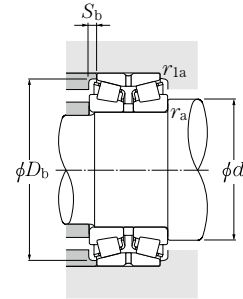

Dynamic equivalent radial load

$$P_r = X F_r + Y F_a$$

$\frac{F_a}{F_r} \leq e$		$\frac{F_a}{F_r} > e$	
X	Y	X	Y
1	Y ₁	0.67	Y ₂

Static equivalent radial load

$$P_{0r} = F_r + Y_0 F_a$$

For values of e, Y₁, Y₂ and Y₀ see the table below.

Bearing number 2)	Abutment and fillet dimensions					Load center mm a	Constant e	Axial load factors			Mass kg (approx.)
	d _a Min.	D _b Min.	mm S _b Min.	r _{as} Max.	r _{1as} Max.			Y ₁	Y ₂	Y ₀	
413122	122	170.5	3	2	0.6	66.5	0.40	1.68	2.50	1.64	4.93
423122	122	167.5	7	2	0.6	66.5	0.33	2.03	3.02	1.98	6.38
430222XU	124	188.5	9	2.5	1	90	0.42	1.61	2.39	1.57	11.4
432222XU	124	192	10	2.5	1	102.5	0.42	1.61	2.39	1.57	15.8
430322U	128	222	12.5	3	1	99	0.35	1.96	2.91	1.91	23.9
432322U	128	224	19.5	3	1	127	0.35	1.96	2.91	1.91	37.4
413024	132	172	2.5	2	0.6	59	0.37	1.80	2.69	1.76	3.85
423024	132	171.5	6	2	0.6	66	0.37	1.80	2.69	1.76	4.35
413124	132	185.5	3.5	2	0.6	76.5	0.43	1.57	2.34	1.53	7.24
423124	132	189.5	8	2	0.6	76.5	0.37	1.80	2.69	1.76	8.69
430224XU	134	203	9.5	2.5	1	98	0.44	1.55	2.31	1.52	13.8
432224XU	134	206	11.5	2.5	1	112.5	0.44	1.55	2.31	1.52	19.2
430324XU	138	239	13.5	3	1	107	0.35	1.96	2.91	1.91	30.3
432324U	138	240.5	21.5	3	1	129.5	0.35	1.96	2.91	1.91	47
413026	142	188	3	2	0.6	66	0.37	1.80	2.69	1.76	5.55
423026	142	190.5	6.5	2	0.6	71.5	0.37	1.80	2.69	1.76	6.62
413126	142	197	3.5	2	0.6	69	0.33	2.03	3.02	1.98	7.83
423126	142	199.5	8	2	0.6	79.5	0.37	1.80	2.69	1.76	9.4
430226XU	148	218	9.5	3	1	101.5	0.44	1.55	2.31	1.52	15.3
432226XU	148	220.5	13.5	3	1	123.5	0.44	1.55	2.31	1.52	24
* 430326XUUTG	152	257.5	14.5	4	1.5	116.5	0.35	1.96	2.91	1.91	37.9
* 432326UTG	148	264	20.5	3	1.5	143	0.35	1.95	2.90	1.91	56.6
413028	152	200	3	2	0.6	68.5	0.37	1.80	2.69	1.76	5.73
423028	152	198	6.5	2	0.6	75	0.37	1.84	2.74	1.80	7.07
413128	154	212	3.5	2.5	1	73.5	0.33	2.03	3.02	1.98	9.29
423128	154	211	8	2.5	1	88	0.37	1.80	2.69	1.76	11.1
430228XU	158	235	9.5	3	1	107.5	0.44	1.55	2.31	1.52	19.2
432228XU	158	239.5	13.5	3	1	131.5	0.44	1.55	2.31	1.52	30
* 430328XUUTG	162	275.5	14.5	4	1.5	122.5	0.35	1.96	2.91	1.91	45.3
430328X	158	275.5	14.5	4	1.5	123.5	0.35	1.95	2.90	1.91	43.2
* 432328UTG	158	280.5	22.5	3	1.5	156	0.35	1.95	2.90	1.91	68.9
413030	164	213.5	3	2.5	1	73.5	0.37	1.80	2.69	1.76	6.66
423030	164	213	7	2.5	1	79.5	0.37	1.80	2.69	1.76	8.48
413130	164	232.5	4.5	2.5	1	83.5	0.33	2.03	3.02	1.98	14.6
423130	164	236	10	2.5	1	96.5	0.37	1.80	2.69	1.76	17.6

2) Bearing numbers marked "*" designate ULTAGE series bearings.

Double Row Tapered Roller Bearings



Back-to-back arrangement

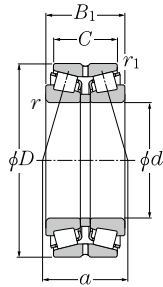

a 150 ~ 200mm

d	Boundary dimensions					Basic load rating		Fatigue load limit kN C _u	Allowable speed	
	D	B ₁	C	r _{s min} ¹⁾	r _{1s min} ¹⁾	dynamic	static		Grease lubrication	Oil lubrication
	mm	mm	mm	mm	mm	C _r	C _{0r}		min ⁻¹	min ⁻¹
150	270	109	87	4	1	855	1 210	118	1 100	1 500
	270	164	130	4	1	1 330	2 140	209	1 100	1 500
	320	154	120	5	1.5	1 810	2 140	201	990	1 400
160	240	60	53	3	1	370	535	53.0	1 100	1 500
	240	75	60	3	1	475	765	76.0	1 100	1 500
	270	86	76	3	1	760	965	93.0	1 100	1 600
	270	108	86	3	1	865	1 180	114	1 100	1 600
	290	115	91	4	1	1 150	1 440	137	1 000	1 400
	290	178	144	4	1	1 960	2 840	272	1 000	1 400
340	160	126	5	1.5	2 010	2 390	221	920	1 300	
170	260	67	60	3	1	405	620	60.0	1 100	1 400
	260	84	67	3	1	545	865	83.5	1 100	1 400
	280	88	78	3	1	705	900	86.0	1 000	1 500
	280	110	88	3	1	930	1 270	122	1 000	1 500
	310	125	97	5	1.5	1 340	1 690	159	950	1 400
310	192	152	5	1.5	2 190	3 200	300	950	1 400	
180	280	74	66	3	1	545	735	69.5	1 000	1 400
	280	93	74	3	1	745	1 050	99.5	1 000	1 400
	300	96	85	4	1.5	910	1 190	111	940	1 400
	300	120	96	4	1.5	1 130	1 530	144	940	1 400
	320	127	99	5	1.5	1 380	1 780	165	890	1 300
	320	192	152	5	1.5	2 260	3 350	315	890	1 300
190	290	75	67	3	1	555	740	69.5	940	1 400
	290	94	75	3	1	790	1 110	104	940	1 400
	320	104	92	4	1.5	1 000	1 280	118	890	1 300
	320	130	104	4	1.5	1 260	1 710	157	890	1 300
	340	133	105	5	1.5	1 570	2 010	183	840	1 200
	340	204	160	5	1.5	2 530	3 700	335	840	1 200
200	310	82	73	3	1	680	940	87.0	900	1 300
	310	103	82	3	1	920	1 320	121	900	1 300
	340	112	100	4	1.5	1 240	1 660	150	840	1 200
	340	140	112	4	1.5	1 400	1 910	173	840	1 200
	360	142	110	5	1.5	1 730	2 210	198	800	1 100
	360	218	174	5	1.5	2 900	4 250	380	800	1 100

1) Smallest allowable dimension for chamfer dimension r or r₁.

Double Row Tapered Roller Bearings

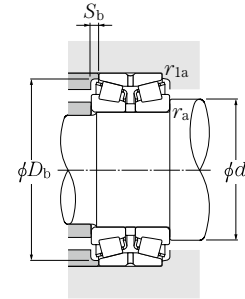

Dynamic equivalent radial load

$$P_r = X F_r + Y F_a$$

$\frac{F_a}{F_r} \leq e$		$\frac{F_a}{F_r} > e$	
X	Y	X	Y
1	Y ₁	0.67	Y ₂

Static equivalent radial load

$$P_{0r} = F_r + Y_0 F_a$$

For values of e, Y₁, Y₂ and Y₀ see the table below.

Bearing number ²⁾	Abutment and fillet dimensions					Load center mm a	Constant e	Axial load factors			Mass kg (approx.)
	d _a Min.	D _b Min.	mm S _b Min.	r _{as} Max.	r _{1as} Max.			Y ₁	Y ₂	Y ₀	
430230U	168	251.5	11	3	1	114	0.44	1.55	2.31	1.52	24.1
432230XU	168	256	17	3	1	139	0.44	1.55	2.31	1.52	38
* 430330UUTG	172	294.5	17	4	1.5	131.5	0.35	1.96	2.91	1.91	54.6
413032	174	228.5	3.5	2.5	1	79	0.37	1.80	2.69	1.76	8.39
423032	174	228.5	7.5	2.5	1	85.5	0.37	1.80	2.69	1.76	10.7
* 413132UTG	174	256	5	2.5	1	98.5	0.40	1.68	2.50	1.64	18.2
* 423132UTG	174	252	11	2.5	1	106	0.37	1.80	2.69	1.76	22.5
* 430232UUTG	178	271	12	3	1	122	0.44	1.55	2.31	1.52	29.3
* 432232UUTG	178	277	17	3	1	149.5	0.44	1.55	2.31	1.52	49.9
* 430332XUUTG	182	312.5	17	4	1.5	137.5	0.35	1.96	2.91	1.91	63.8
413034	184	243.5	3.5	2.5	1	86.5	0.37	1.80	2.69	1.76	11.6
423034	184	245.5	8.5	2.5	1	93.5	0.37	1.80	2.69	1.76	14.3
* 413134UTG	184	262	5	2.5	1	104	0.40	1.68	2.50	1.64	19.2
* 423134UTG	184	262	11	2.5	1	108.5	0.37	1.80	2.69	1.76	24.2
* 430234UUTG	192	290.5	14	4	1.5	132.5	0.44	1.55	2.31	1.52	37.1
* 432234XUUTG	192	296	20	4	1.5	160	0.44	1.55	2.31	1.52	61.3
* 413036UTG	194	262	4	2.5	1	94	0.37	1.80	2.69	1.76	15.2
* 423036UTG	194	264	9.5	2.5	1	102	0.37	1.80	2.69	1.76	19
* 413136UTG	198	282	5.5	3	1.5	110.5	0.40	1.68	2.50	1.64	25
* 423136UTG	198	281	12	3	1.5	119	0.37	1.80	2.69	1.76	30.1
* 430236UUTG	202	300	14	4	1.5	139	0.45	1.50	2.23	1.47	39.1
* 432236UUTG	202	305.5	20	4	1.5	165	0.45	1.50	2.23	1.47	63.8
* 413038UTG	204	272.5	4	2.5	1	96	0.37	1.80	2.69	1.76	15.9
* 423038UTG	204	274	9.5	2.5	1	104.5	0.37	1.80	2.69	1.76	16.1
* 413138UTG	208	303	6	3	1.5	118.5	0.40	1.68	2.50	1.64	30.3
* 423138UTG	208	302	13	3	1.5	126.5	0.37	1.80	2.69	1.76	37.7
* 430238UUTG	212	321	14	4	1.5	141.5	0.44	1.55	2.31	1.52	47
* 432238UUTG	212	325.5	22	4	1.5	173.5	0.44	1.55	2.31	1.52	75.6
* 413040UTG	214	289.5	4.5	2.5	1	103	0.37	1.80	2.69	1.76	20.9
* 423040UTG	214	293	10.5	2.5	1	112	0.37	1.80	2.69	1.76	26.6
* 413140UTG	218	320	6	3	1.5	125.5	0.40	1.68	2.50	1.64	38.6
* 423140UTG	218	319	14	3	1.5	134.5	0.37	1.80	2.69	1.76	47.3
* 430240UUTG	222	338	16	4	1.5	154	0.44	1.55	2.31	1.52	55.8
* 432240UUTG	222	342.5	22	4	1.5	180	0.41	1.66	2.47	1.62	91.5

2) Bearing numbers marked "*" designate ULTAGE series bearings.

● Double Row Tapered Roller Bearings



Back-to-back arrangement

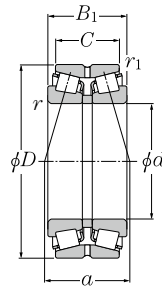

a 220 ~ 340mm

	Boundary dimensions					Basic load rating		Fatigue load limit kN C _u	Allowable speed	
	d	D	B ₁	C	r _{s min} ¹⁾	r _{1s min} ¹⁾	dynamic C _R		static C _{0R}	min ⁻¹ Grease lubrication
220	340	90	80	4	1.5	765	1 060	94.5	810	1 200
	340	113	90	4	1.5	1 130	1 650	148	810	1 200
	370	120	107	5	1.5	1 420	1 920	169	760	1 100
	370	150	120	5	1.5	1 570	2 260	199	760	1 100
	400	158	122	4	1.5	1 790	2 440	212	710	1 000
240	360	92	82	4	1.5	840	1 160	101	730	1 000
	360	115	92	4	1.5	1 170	1 770	155	730	1 000
	400	128	114	5	1.5	1 580	2 130	183	690	1 000
	400	160	128	5	1.5	1 790	2 600	223	690	1 000
	440	165	127	4	1.5	2 150	2 960	250	640	900
260	440	266	212	4	1.5	3 750	5 500	465	640	900
	400	104	92	5	1.5	1 070	1 540	131	670	1 000
	400	130	104	5	1.5	1 470	2 190	187	670	1 000
	440	144	128	5	1.5	1 920	2 630	220	630	910
280	440	180	144	5	1.5	2 510	3 750	310	630	910
	420	106	94	5	1.5	1 140	1 630	137	620	880
	420	133	106	5	1.5	1 540	2 340	196	620	880
	460	146	130	6	2	2 100	2 900	239	580	830
300	460	183	146	6	2	2 480	3 650	300	580	830
	460	118	105	5	1.5	1 370	1 990	163	570	810
	460	148	118	5	1.5	2 070	3 150	257	570	810
	500	160	142	6	2	2 580	3 600	290	530	770
320	500	200	160	6	2	2 690	4 050	325	530	770
	480	121	108	5	1.5	1 520	2 250	181	530	750
	480	151	121	5	1.5	2 030	3 100	247	530	750
	540	176	157	6	2	2 870	4 100	320	500	710
340	540	220	176	6	2	3 200	4 900	385	500	710
	520	133	118	6	2	1 890	2 870	226	500	700
	520	165	133	6	2	2 420	3 750	295	500	700
	580	190	169	6	2	3 450	4 900	380	460	660
	580	238	190	6	2	4 300	6 500	500	460	660

1) Smallest allowable dimension for chamfer dimension r or r₁.

● Double Row Tapered Roller Bearings

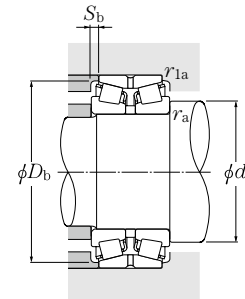

Dynamic equivalent radial load

$$P_r = X F_r + Y F_a$$

$\frac{F_a}{F_r} \leq e$		$\frac{F_a}{F_r} > e$	
X	Y	X	Y
1	Y ₁	0.67	Y ₂

Static equivalent radial load

$$P_{0r} = F_r + Y_0 F_a$$

For values of e, Y₁, Y₂ and Y₀ see the table below.

Bearing number 2)	Abutment and fillet dimensions					Load center mm a	Constant e	Axial load factors			Mass kg (approx.)
	d _a Min.	D _b Min.	mm S _b Min.	r _{as} Max.	r _{1as} Max.			Y ₁	Y ₂	Y ₀	
* 413044UTG	238	320	5	3	1.5	111.5	0.37	1.80	2.69	1.76	27.1
* 423044UTG	238	321	11.5	3	1.5	124.5	0.37	1.80	2.69	1.76	33
* 413144UTG	242	349	6.5	4	1.5	135	0.40	1.68	2.50	1.64	47.8
* 423144UTG	242	344	15	4	1.5	154	0.40	1.68	2.50	1.64	58.1
* 430244UTG	238	368	18	3	1.5	178.5	0.49	1.38	2.06	1.35	77
* 413048UTG	258	341	5	3	1.5	117.5	0.37	1.80	2.69	1.76	29.1
* 423048UTG	258	340.5	11.5	3	1.5	130.5	0.37	1.80	2.69	1.76	36.3
* 413148UTG	262	378	7	4	1.5	144.5	0.40	1.68	2.50	1.64	58.5
* 423148UTG	262	376	16	4	1.5	164	0.40	1.68	2.50	1.64	71.4
* 430248UTG	258	406	19	3	1.5	189	0.49	1.38	2.06	1.35	100
* 432248UTG	258	421.5	27	3	1.5	226	0.43	1.57	2.34	1.53	160
* 413052UTG	282	375	6	4	1.5	130.5	0.37	1.80	2.69	1.76	43.4
* 423052UTG	282	377	13	4	1.5	143	0.37	1.80	2.69	1.76	53
* 413152UTG	282	415	8	4	1.5	161	0.40	1.68	2.50	1.64	82
* 423152UTG	282	416	18	4	1.5	176.5	0.40	1.68	2.50	1.64	100
* 413056UTG	302	396.5	6	4	1.5	136.5	0.37	1.80	2.69	1.76	46
* 423056UTG	302	399.5	13.5	4	1.5	148.5	0.37	1.80	2.69	1.76	56.8
* 413156UTG	308	438	8	5	2	168	0.40	1.68	2.50	1.64	85.5
* 423156UTG	308	435.5	18.5	5	2	182.5	0.40	1.68	2.50	1.64	110
* 413060UTG	322	431	6.5	4	1.5	151	0.37	1.80	2.69	1.76	65.6
* 423060UTG	322	436.5	15	4	1.5	163	0.37	1.80	2.69	1.76	77.8
* 413160UTG	328	475	9	5	2	182	0.40	1.68	2.50	1.64	110
* 423160UTG	328	467	20	5	2	201.5	0.40	1.68	2.50	1.64	140
* 413064UTG	342	452	6.5	4	1.5	156.5	0.37	1.80	2.69	1.76	69.2
* 423064UTG	342	457.5	15	4	1.5	170	0.37	1.80	2.69	1.76	82
* 413164UTG	348	509	9.5	5	2	197.5	0.40	1.68	2.50	1.64	150
* 423164UTG	348	504.5	22	5	2	216.5	0.40	1.68	2.50	1.64	190
* 413068UTG	368	491	7.5	5	2	169.5	0.37	1.80	2.69	1.76	93.1
* 423068UTG	368	492	16	5	2	184	0.37	1.80	2.69	1.76	110
* 413168UTG	368	548	10.5	5	2	213	0.40	1.68	2.50	1.64	190
* 423168UTG	368	546	24	5	2	237	0.40	1.68	2.50	1.64	240

2) Bearing numbers marked "*" designate ULTAGE series bearings.

● Double Row Tapered Roller Bearings



Back-to-back arrangement

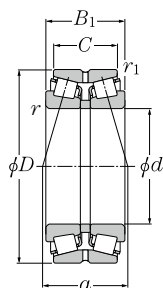

a 360 ~ 500mm

	Boundary dimensions						Basic load rating		Fatigue load limit kN C _u	Allowable speed	
	d	D	B ₁	C	r _{s min} ¹⁾	r _{1s min} ¹⁾	dynamic C _r	static C _{0r}		Grease lubrication	Oil lubrication
360	540	134	120	6	2	1 880	2 810	218	460	660	
	540	169	134	6	2	2 630	4 200	325	460	660	
	600	192	171	6	2	3 500	5 050	385	430	620	
	600	240	192	6	2	4 100	6 500	495	430	620	
380	560	135	122	6	2	2 170	3 350	255	440	620	
	560	171	135	6	2	2 670	4 350	335	440	620	
	620	194	173	6	2	3 650	5 250	395	410	580	
	620	243	194	6	2	4 250	6 700	505	410	580	
400	600	148	132	6	2	2 390	3 700	276	410	580	
	600	185	148	6	2	3 250	5 450	410	410	580	
	650	200	178	6	3	3 850	5 800	430	380	540	
	650	250	200	6	3	4 800	7 850	580	380	540	
420	620	150	134	6	2	2 710	4 250	315	390	550	
	620	188	150	6	2	3 400	5 900	435	390	550	
	700	224	200	6	3	4 750	7 200	525	360	510	
	700	280	224	6	3	6 150	9 700	705	360	510	
440	650	157	140	6	3	3 150	5 150	375	370	520	
	650	196	157	6	3	3 350	5 450	400	370	520	
	720	226	201	6	3	5 150	7 800	560	340	480	
	720	283	226	6	3	6 400	10 300	740	340	480	
460	680	163	145	6	3	3 350	5 350	390	350	500	
	680	204	163	6	3	3 950	6 750	485	350	500	
	760	300	240	7.5	4	6 300	10 300	725	320	450	
480	700	165	147	6	3	3 200	5 000	360	330	470	
	700	206	165	6	3	3 900	6 700	480	330	470	
	790	310	248	7.5	4	6 750	11 100	775	310	430	
500	720	167	149	6	3	3 350	5 400	380	320	450	
	720	209	167	6	3	3 950	6 900	485	320	450	
	830	264	235	7.5	4	6 700	10 500	725	290	410	

1) Smallest allowable dimension for chamfer dimension r or r₁.

● Double Row Tapered Roller Bearings

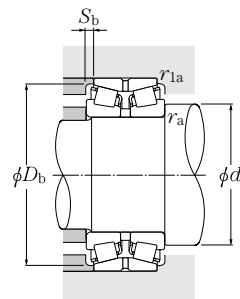

Dynamic equivalent radial load

$$P_r = X F_r + Y F_a$$

$\frac{F_a}{F_r} \leq e$		$\frac{F_a}{F_r} > e$	
X	Y	X	Y
1	Y ₁	0.67	Y ₂

Static equivalent radial load

$$P_{0r} = F_r + Y_0 F_a$$

For values of e, Y₁, Y₂ and Y₀ see the table below.

Bearing number ²⁾	Abutment and fillet dimensions					Load center mm a	Constant e	Axial load factors			Mass kg (approx.)
	d _a Min.	D _b Min.	mm S _b Min.	r _{as} Max.	r _{1as} Max.			Y ₁	Y ₂	Y ₀	
* 413072UTG	388	510	7	5	2	176	0.37	1.80	2.69	1.76	98.2
* 423072UTG	388	512	17.5	5	2	192	0.37	1.80	2.69	1.76	120
* 413172UTG	388	565	10.5	5	2	218.5	0.40	1.68	2.50	1.64	200
* 423172UTG	388	563.5	24	5	2	239.5	0.40	1.68	2.50	1.64	250
* 413076UTG	408	532	6.5	5	2	183	0.37	1.80	2.69	1.76	100
* 423076UTG	408	532	18	5	2	196.5	0.37	1.80	2.69	1.76	130
* 413176UTG	408	587	10.5	5	2	224.5	0.40	1.68	2.50	1.64	210
* 423176UTG	408	582	24.5	5	2	249	0.40	1.68	2.50	1.64	260
* 413080UTG	428	567	8	5	2	194	0.37	1.80	2.69	1.76	130
* 423080UTG	428	567	18.5	5	2	210	0.37	1.80	2.69	1.76	170
* 413180UTG	428	614	11	5	2.5	232	0.40	1.68	2.50	1.64	240
* 423180UTG	428	613.5	25	5	2.5	256.5	0.40	1.68	2.50	1.64	290
* 413084UTG	448	589	8	5	2	199.5	0.37	1.80	2.69	1.76	140
* 423084UTG	448	586	19	5	2	220	0.37	1.80	2.69	1.76	180
* 413184UTG	448	658.5	12	5	2.5	258	0.40	1.68	2.50	1.64	320
* 423184UTG	448	663	28	5	2.5	287	0.40	1.68	2.50	1.64	380
* 413088UTG	468	618	8.5	5	2.5	208	0.37	1.80	2.69	1.76	160
* 423088UTG	468	617.5	19.5	5	2.5	229.5	0.37	1.80	2.69	1.76	190
* 413188UTG	468	675	12.5	5	2.5	263	0.40	1.68	2.50	1.64	330
* 423188UTG	468	681.5	28.5	5	2.5	288.5	0.40	1.68	2.50	1.64	460
* 413092UTG	488	650	9	5	2.5	217.5	0.37	1.80	2.69	1.76	180
* 423092UTG	488	647.5	20.5	5	2.5	239.5	0.37	1.80	2.69	1.76	230
* 423192UTG	496	715.5	30	6	3	305	0.40	1.68	2.50	1.64	480
* 413096UTG	508	669	9	5	2.5	222.5	0.37	1.80	2.69	1.76	190
* 423096UTG	508	667.5	20.5	5	2.5	245.5	0.37	1.80	2.69	1.76	240
* 423196UTG	516	761.5	31	6	3	328.5	0.40	1.68	2.50	1.64	540
* 4130500UTG	528	690	9	5	2.5	230	0.37	1.80	2.69	1.76	200
* 4230500UTG	528	687	21	5	2.5	249.5	0.37	1.80	2.69	1.76	250
* 4131500UTG	536	784	14.5	6	3	296	0.40	1.68	2.50	1.64	530

2) Bearing numbers marked "*" designate ULTAGE series bearings.

● Double Row Tapered Roller Bearings

NTN

Back-to-back arrangement

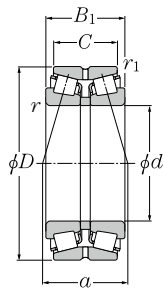

a 530 ~ 710mm

	Boundary dimensions					Basic load rating		Fatigue load limit kN C_u	Allowable speed	
	d	D	B_1	C	$r_{s \min}^{1)}$	$r_{1s \min}^{1)}$	dynamic kN C_r		static C_{0r}	min ⁻¹ Grease lubrication
530	780	185	163	6	3	3 750	5 900	410	290	420
600	870	200	176	6	3	5 000	8 550	570	250	360

1) Smallest allowable dimension for chamfer dimension r or r_1 .

● Double Row Tapered Roller Bearings

NTN

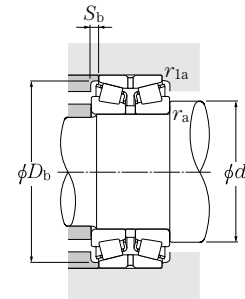

Dynamic equivalent radial load

$$P_r = XF_r + YF_a$$

$\frac{F_a}{F_r} \leq e$		$\frac{F_a}{F_r} > e$	
X	Y	X	Y
1	Y_1	0.67	Y_2

Static equivalent radial load

$$P_{0r} = F_r + Y_0 F_a$$

For values of e , Y_1 , Y_2 and Y_0 see the table below.

Bearing number 2)	Abutment and fillet dimensions					Load center mm a	Constant e	Axial load factors			Mass kg (approx.)
	d_a Min.	D_b Min.	mm S_b Min.	r_{as} Max.	r_{1as} Max.			Y_1	Y_2	Y_0	
* 4130/530UTG	558	740	11	5	2.5	249.5	0.37	1.80	2.69	1.76	270
* 4130/600UTG	628	828	12	5	2.5	277	0.37	1.80	2.69	1.76	350

2) Bearing numbers marked "*" designate ULTAGE series bearings.

● Double Row Tapered Roller Bearings



Face-to-face arrangement

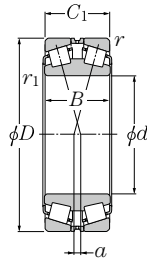

a 110 ~ 280mm

d	Boundary dimensions					Basic load rating		Fatigue load limit kN C _r	Allowable speed	
	D	B	C ₁	r _{1s} min ¹⁾	r _s min ¹⁾	dynamic C _r	static C _{0r}		Grease lubrication	Oil lubrication
110	180	56	56	2.5	2	330	485	53.0	1 600	2 200
	180	46	46	2.5	2	255	375	40.0	1 500	2 100
120	200	62	62	2.5	2	415	610	64.5	1 500	2 000
	200	52	52	2.5	2	325	490	51.5	1 400	1 900
130	210	64	64	2.5	2	455	675	70.5	1 400	1 800
	210	53	53	2.5	2	335	535	55.0	1 300	1 800
140	225	68	68	3	2.5	435	650	66.0	1 200	1 700
	225	56	56	3	2.5	395	630	64.0	1 200	1 600
150	250	80	80	3	2.5	670	1 040	103.0	1 200	1 500
	240	60	60	3	2.5	475	765	76.0	1 100	1 500
160	270	86	86	3	2.5	865	1 180	114	1 100	1 600
	260	67	67	3	2.5	545	865	83.5	1 100	1 400
170	280	88	88	3	2.5	930	1 270	122	1 000	1 500
	280	74	74	3	2.5	745	1 050	99.5	1 000	1 400
180	300	96	96	4	3	1 130	1 530	144	960	1 400
	290	75	75	3	2.5	790	1 110	104	950	1 400
190	320	104	104	4	3	1 260	1 710	157	900	1 300
	310	82	82	3	2.5	920	1 320	121	900	1 300
200	340	112	112	4	3	1 400	1 910	173	850	1 200
	340	90	90	4	3	1 130	1 650	148	810	1 200
220	370	120	120	5	4	1 570	2 260	199	770	1 100
	360	92	92	4	3	1 170	1 770	155	730	1 000
240	400	128	128	5	4	1 790	2 600	223	700	1 000
	400	104	104	5	4	1 470	2 190	187	670	1 000
260	440	144	144	5	4	2 510	3 750	310	640	910
	440	104	104	5	4	1 470	2 190	187	670	1 000
280	420	106	106	5	4	1 540	2 340	196	610	880

1) Smallest allowable dimension for chamfer dimension r or r₁.

● Double Row Tapered Roller Bearings

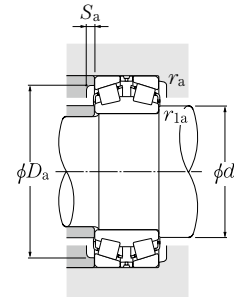

Dynamic equivalent radial load

$$P_r = X F_r + Y F_a$$

$\frac{F_a}{F_r} \leq e$		$\frac{F_a}{F_r} > e$	
X	Y	X	Y
1	Y ₁	0.67	Y ₂

Static equivalent radial load

$$P_{0r} = F_r + Y_0 F_a$$

For values of e, Y₁, Y₂ and Y₀ see the table below.

Bearing number 2)	Installation-related dimensions						Load center mm a	Constant e	Axial load factors			Mass kg (approx.)
	d _a Max.	D _a Max.	S _a Min.	r _{1as} Max.	r _{as} Max.	Y ₁			Y ₂	Y ₀		
323122	126.5	170	157.5	8	2	2	1	0.33	2.03	3.02	1.98	5.54
323024	134	168	162.5	8	2	2	12	0.37	1.80	2.69	1.76	4.08
323124	141.5	190	176	8	2	2	6.5	0.37	1.80	2.69	1.76	7.82
323026	148.5	190	178.5	8	2	2	13.5	0.37	1.80	2.69	1.76	5.74
323126	147.5	200	185	8	2	2	7.5	0.37	1.80	2.69	1.76	8.38
323028	157.5	200	187.5	8	2	2	14	0.37	1.84	2.74	1.80	6.36
323128	161	213	197.5	10	2.5	2	8	0.37	1.80	2.69	1.76	9.82
323030	167.5	213	200	10	2.5	2	15.5	0.37	1.80	2.69	1.76	7.63
323130	175.5	238	219	10	2.5	2	6.5	0.37	1.80	2.69	1.76	15.7
323032	179	228	215.5	10	2.5	2	17.5	0.37	1.80	2.69	1.76	9.42
* 323132UTG	187.5	258	233.5	10	2.5	2	8	0.37	1.80	2.69	1.76	20
323034E1	192	248	231	10	2.5	2	18	0.37	1.80	2.69	1.76	12.8
* 323134UTG	195.5	268	244	10	2.5	2	8.5	0.37	1.80	2.69	1.76	21.8
* 323036UTG	205	268	248.5	10	2.5	2	17	0.37	1.80	2.69	1.76	16.5
* 323136UTG	206	286	262	12	3	2.5	8	0.37	1.80	2.69	1.76	27.2
* 323038UTG	213	278	258	12	2.5	2	17.5	0.37	1.80	2.69	1.76	17.9
* 323138UTG	220.5	306	279.5	12	3	2.5	8.5	0.37	1.80	2.69	1.76	33.2
* 323040UTG	225.5	298	275	12	2.5	2	19	0.37	1.80	2.69	1.76	22.3
* 323140UTG	233	326	294.5	12	3	2.5	8.5	0.37	1.80	2.69	1.76	41.8
* 323044UTG	249	326	302.5	12	3	2.5	21.5	0.37	1.80	2.69	1.76	29.8
* 323144UTG	254.5	352	317	14	4	3	14	0.40	1.68	2.50	1.64	52.2
* 323048UTG	269	346	322	14	3	2.5	25.5	0.37	1.80	2.69	1.76	32.5
* 323148UTG	277.5	382	347	14	4	3	17	0.40	1.68	2.50	1.64	63.4
* 323052UTG	291.5	382	354.5	14	4	3	25	0.37	1.80	2.69	1.76	47.7
* 323152UTG	300.5	422	381.5	16	4	3	16.5	0.40	1.68	2.50	1.64	90.5
* 323056UTG	311.5	402	376	16	4	3	29.5	0.37	1.80	2.69	1.76	50.5

2) Bearing numbers marked "*" designate ULTAGE series bearings.

● Double Row Tapered Roller Bearings



Face-to-face arrangement

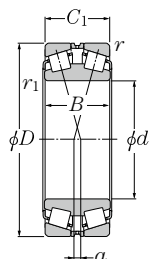

d 280 ~ 710mm

d	Boundary dimensions					Basic load rating		Fatigue load limit kN C _r	Allowable speed	
	D	B	C ₁	r _{1s} min ¹⁾	r _s min ¹⁾	dynamic C _r	static C _{0r}		Grease min ⁻¹	Oil lubrication
280	460	146	146	6	5	2 480	3 650	300	590	830
	460	118	118	5	4	2 070	3 150	257	570	810
300	500	160	160	6	5	2 690	4 050	325	540	770
	480	121	121	5	4	2 030	3 100	247	530	750
320	540	176	176	6	5	3 200	4 900	385	500	710
	520	133	133	6	5	2 420	3 750	295	490	700
340	580	190	190	6	5	4 300	6 500	500	460	660
	540	134	134	6	5	2 630	4 200	325	460	660
360	600	192	192	6	5	4 100	6 500	495	430	620
	560	135	135	6	5	2 310	4 350	335	440	580
380	620	194	194	6	5	3 700	6 700	505	410	540
	600	148	148	6	5	3 250	5 450	410	410	580
400	650	200	200	6	6	4 800	7 850	580	380	540
	620	150	150	6	5	3 400	5 900	435	390	550
420	700	224	224	6	6	6 150	9 700	705	360	510
	650	157	157	6	6	3 350	5 450	400	370	520
440	720	226	226	6	6	6 400	10 300	740	340	480
	680	163	163	6	6	3 950	6 750	485	350	500
460	760	240	240	7.5	7.5	6 300	10 300	725	320	450
	700	165	165	6	6	3 900	6 700	480	330	470
480	790	248	248	7.5	7.5	6 750	11 100	775	300	430
	720	167	167	6	6	3 950	6 900	485	320	450

1) Smallest allowable dimension for chamfer dimension r or r₁.
B-208

● Double Row Tapered Roller Bearings

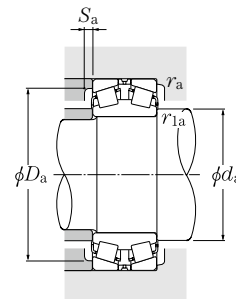

Dynamic equivalent radial load

$$P_r = X F_r + Y F_a$$

$\frac{F_a}{F_r} \leq e$		$\frac{F_a}{F_r} > e$	
X	Y	X	Y
1	Y ₁	0.67	Y ₂

Static equivalent radial load

$$P_{0r} = F_r + Y_0 F_a$$

For values of e, Y₁, Y₂ and Y₀ see the table below.

Bearing number 2)	Installation-related dimensions						Load center mm	Constant e	Axial load factors			Mass kg (approx.)
	d _a Max.	D _a Max.	D _a Min.	S _a Min.	r _{1as} Max.	r _{as} Max.			Y ₁	Y ₂	Y ₀	
* 323156UTG	318.5	438	402	16	5	4	19.5	0.40	1.68	2.50	1.64	93.6
* 323060UTG	337	442	566	16	4	3	31	0.37	1.80	2.69	1.76	69.2
* 323160UTG	344.5	478	432	16	5	4	16.5	0.40	1.68	2.50	1.64	130
* 323064UTG	354	462	432	16	4	3	34	0.37	1.80	2.69	1.76	73.4
* 323164UTG	369.5	518	464	18	5	4	18.5	0.40	1.68	2.50	1.64	170
* 323068UTG	379	498	463.5	18	5	4	36	0.37	1.80	2.69	1.76	100
* 323168UTG	388.5	558	500	18	5	4	20.5	0.40	1.68	2.50	1.64	210
* 323072UTG	398	518	483.5	18	5	4	41	0.37	1.80	2.69	1.76	110
* 323172UTG	412.5	578	518.5	18	5	4	25.5	0.40	1.68	2.50	1.64	220
323076	418	538	504	18	5	4	42.5	0.37	1.80	2.69	1.76	110
323176	428	598	537.5	20	5	4	27	0.40	1.68	2.50	1.64	230
* 323080UTG	444	578	535.5	18	5	4	45	0.37	1.80	2.69	1.76	150
* 323180UTG	452.5	622	566	20	5	5	32.5	0.40	1.68	2.50	1.64	260
* 323084UTG	464.5	598	555	20	5	4	50	0.37	1.80	2.69	1.76	150
* 323184UTG	475	672	611	25	5	5	35	0.40	1.68	2.50	1.64	350
* 323088UTG	485.5	622	584	20	5	5	52.5	0.37	1.80	2.69	1.76	180
* 323188UTG	493.5	692	629	25	5	5	33	0.40	1.68	2.50	1.64	360
* 323092UTG	507.5	652	612.5	25	5	5	56.5	0.37	1.80	2.69	1.76	200
* 323192UTG	525	724	660	25	6	6	31	0.40	1.68	2.50	1.64	430
* 323096UTG	527	672	632.5	25	5	5	60.5	0.37	1.80	2.69	1.76	210
* 323196UTG	547.5	754	688.5	30	6	6	34.5	0.40	1.68	2.50	1.64	480
* 3230/500UTG	548.5	692	652	25	5	5	61.5	0.37	1.80	2.69	1.76	220

2) Bearing numbers marked "*" designate ULTAGE series bearings.
B-209

Spherical Roller Bearings



1. Types, design features, and characteristics

Spherical roller bearings consist of an outer ring having a continuous spherical raceway and two rows of barrel-shaped rollers guided by an inner ring with two raceways. (Refer to **Fig. 1**) This bearing has self-aligning properties, and therefore is suited for use where misalignment between the inner and outer rings occurs from housing installation error or shaft bending.

Spherical roller bearings have a large capacity for radial loads, axial loads in either direction, and combined loads. They are also suited for applications where vibration and shock loads are encountered. When spherical roller bearings are used with a vertical shaft or under a large axial load, the load on the rollers of the row that is not subject to the axial load becomes small, and the resulting skidding on the rollers may result in wear. If the ratio of the axial load to the radial load exceeds the factor e in the dimension table ($F_a/F_r > e$), consult **NTN** Engineering.

In addition to spherical roller bearings with cylindrical bores, spherical roller bearings with tapered bores are also available. Bearings with tapered bores are specified by the suffix "K" at the end of the spherical roller bearing part number. The standard taper ratio is 1:12 for bearings with a "K" suffix; for bearings in series 240 and 241, the suffix "K30" indicates the taper ratio for a bearing is 1:30. Most tapered bore bearings incorporate the use of adapters and withdrawal sleeves for shaft mounting.

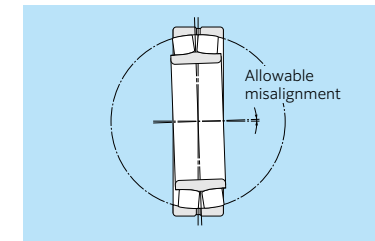
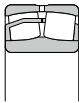
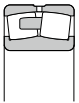
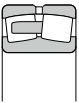

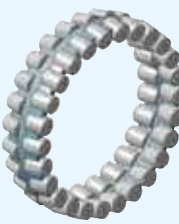
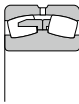
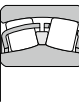
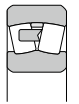
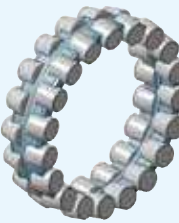

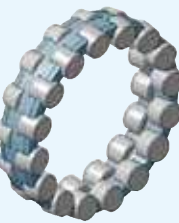

Fig. 1

Table 1 Types of spherical roller bearings

Type	ULTAGE series ¹⁾		
	EA type	EM type	EM type (large size)
Design			
Bearing series	Series other than 213 with outer diameter of 420 mm or smaller		Series with outer diameter of 440 to 580 mm
Rollers	Symmetrical		
Cage type	Pressed cage	Machined cage	Machined cage
Cage shape			
Max. operating temperature	200°C		
Type	B type	213C type	213 type
Design			
Bearing series	Other than ULTAGE series (outer diameter of 300 mm or larger)	Series 213 with bore diameter of 50 mm or smaller	Series 213 with bore diameter of 55 mm or larger
Rollers	Asymmetrical	Symmetrical	Asymmetrical
Cage type	Two-piece machined cage	Two-piece pressed cage	Machined cage
Cage shape			
Max. operating temperature	120°C (instantaneous) 100°C (continuous)		

1) ULTAGE series spherical roller bearings has been developed for "longer life," "improved loading capability," and "higher speed," which are required for various types of industrial machinery.
For details, please refer to the special catalog "ULTAGE series spherical roller bearings [EA and EM types] (CAT. No. 3033/E)."

2. ULTAGE series fits

Table 2 Shaft tolerance class in common use

Condition	Shaft diameter (mm)		Shaft tolerance class	Note	
	Over	Incl.			
Cylindrical bore bearing (class 0)					
Inner ring rotational load or load of undetermined direction	Light load ¹⁾ or Normal load ¹⁾ or Fluctuating load	18	25	k5	
		25	40	m5	
		40	60	n5	
		60	100	n6	
	Heavy load ¹⁾ or Impact load	100	200	p6	Use bearings with larger internal clearances than CN clearance bearings.
		200	500	r6	
		500			
Inner ring: Stationary Load	Inner ring must move easily over shaft.	Overall shaft diameter		g6	For large bearings, f6 will suffice to facilitate movement.
	Inner ring does not have to move easily over shaft.	Overall shaft diameter		h6	
Tapered bore bearing (class 0) (with adapter or withdrawal sleeve)					
Full load	Overall shaft diameter		h9/IT5 ³⁾	h10/IT7 ³⁾ will suffice for power transmitting shafts.	

1) Standards for light loads, normal loads, and heavy loads

- Light loads: dynamic equivalent radial load $\leq 0.05 C_r$
- Normal loads: $0.05 C_r < \text{dynamic equivalent radial load} \leq 0.10 C_r$
- Heavy loads: $0.10 C_r < \text{dynamic equivalent radial load}$

2) When the shaft diameter exceeds $\phi 200$ mm and the bearing is to be used under heavy load or impact load conditions, please consult NTN Engineering.

3) The shaft shape error (roundness, cylindricity, etc.) must be within the tolerance range of IT5 and IT7.

Note: 1. All values and fits listed in the above tables are for solid steel shafts.

2. Use the formula below to calculate necessary interference. The upper limit value should not exceed 1/1 000 of the shaft diameter.

$$\left\{ \begin{array}{l} \text{When } F_r \leq 0.3 C_{0r}, \text{ necessary interference } \Delta d_F (\mu\text{m}) \text{ is } \Delta d_F = 0.08 (d \cdot F_r/B)^{1/2} \\ \text{When } F_r > 0.3 C_{0r}, \Delta d_F = 0.02 (F_r/B) \end{array} \right.$$

(d : bearing bore diameter (mm), B : inner ring width (mm), F_r : radial load, (N), C_{0r} : basic static rating load (N))

When the difference between the bearing temperature and the ambient temperature during bearing operation is to be considered, consider the effective interference Δd_{eT} (μm) by the temperature difference as the necessary interference.

$$\Delta d_{eT} = 0.0015 \cdot d \cdot \Delta T$$

(ΔT : Difference between bearing temperature and ambient temperature °C)

Table 3 Housing bore tolerance class in common use

Housing	Condition		Outer ring axial direction movement	Housing bore tolerance class	Note
	Load type, etc.				
Single housing or divided housing	Static outer ring load	All types of loads	Yes	H7	G7 can be used for large bearings or bearings with a large temperature differential between the outer ring and housing.
		Light ¹⁾ or ordinary load ¹⁾	Yes	H8	—
		Shaft and inner ring become hot.	Easily	G7	F7 can be used for large bearings or bearings with a large temperature differential between the outer ring and housing.
Single housing	Indeterminate load	Requires precise rotation under light or ordinary loads.	Basically no	K6	—
		Requires low noise operation.	Yes	JS6	—
		Light or ordinary load	Yes	H6	—
	Rotating outer ring load	Ordinary or heavy load ¹⁾	Basically no	JS7	—
		High impact load	No	K7	—
		Light or fluctuating load	No	M7	—
Rotating outer ring load	Ordinary or heavy load	No	M7	—	
	Heavy load or large impact load with thin wall housing	No	N7	—	
			No	P7	—

1) Standards for light loads, normal loads, and heavy loads

- Light loads: dynamic equivalent radial load $\leq 0.05 C_r$
- Normal loads: $0.05 C_r < \text{dynamic equivalent radial load} \leq 0.10 C_r$
- Heavy loads: $0.10 C_r < \text{dynamic equivalent radial load}$

Note: All values and fits listed in the above tables are for cast iron or steel housings.

3. Allowable speed of ULTAGE series

As the rotational speed of the bearing increases, the temperature of the bearing also increases because of the friction heat produced inside the bearing. Excessive heat will significantly deteriorate the bearing performance, causing abnormal temperature rises and seizure.

Factors affecting the allowable speed of bearings are as follows.

- (1) Bearing type
- (2) Bearing size
- (3) Lubrication (grease lubrication, circulating lubrication, oil lubrication, etc.)
- (4) Bearing internal clearance (bearing internal clearance during operation)
- (5) Bearing load
- (6) Shaft and housing accuracy

The allowable speed specified in the bearing dimension table is the limit for heat dissipation and satisfactory lubrication conditions before the bearing is adversely affected.

The allowable speed of ULTAGE series spherical roller bearings specified in the catalog is defined as follows.

[Oil lubrication]

The allowable speed for oil lubrication is the speed at which the outer ring temperature reaches 80°C with room temperature spindle oil (lubrication oil viscosity: VG32) supplied at 1 liter/min under an operating load of 5% of the basic static load rating C_{0r} .

[Grease lubrication]

The allowable speed for grease lubrication is the speed at which the outer ring temperature reaches 80°C with lithium-based grease (consistency: NLGI3) filled 20%-30% of the free space under an operating load of 5% of the basic static load rating C_{0r} .

In either of the lubrication methods, the bearing temperature rise differs if the usage condition (operating load, rotational speed pattern, lubricating condition, etc.) is different; therefore, the bearings must be selected with sufficient allowable speed as specified in the catalog.

If 80% of the allowable speed specified in the dimension table is exceeded or the bearing is used in vibration or impact conditions, please consult **NTN Engineering**.

See section "9. Allowable speed" for the allowable speed of the spherical roller bearings that are not part of the ULTAGE series.

4. Oil hole and groove for outer ring

Both ULTAGE series and B type spherical roller bearings are provided with oil holes and an oil groove. (See Fig. 2 and Table 4)

Types 213 and C do not have oil holes and grooves. However, they can be made based on customer request. Contact NTN Engineering with the bearing numbers and supplementary suffix code "D1" (refer to page A-48).

If a pin to prevent outer ring rotation is necessary, contact NTN Engineering.

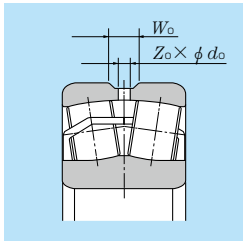

Fig. 2

Table 4 Oil inlet number

Nominal bearing outside diameter mm		Number of oil holes	
		D1	W33 (European spec)
Incl.	Below	Z _o	Z _o
-	320	4	3
320	1 010	8	3
1 010	-	12	-

For oil groove width W_o and diameter of oil hole d_o , see the dimension table.

5. Allowable misalignment angle

Spherical roller bearings have the same self-aligning properties as other self-aligning bearings. The allowable misalignment angle varies according to dimension series and load conditions, but the general allowable misalignment angles are listed below:

- Normal load or more: 1/115
- Light load: 1/30

* Increasing the misalignment angle beyond the allowable angle may cause the rollers to protrude from the outer ring and interfere with nearby components.

6. Adapters and withdrawal sleeves

Adapters are used for installation of bearings with tapered bores on cylindrical shafts. Withdrawal sleeves are also used to install and disassemble bearings with tapered bores onto and off of cylindrical shafts. In disassembling the bearing from the shaft, the nut is turned against the side face of the inner ring utilizing the bolt provided on the withdrawal sleeve, and then the sleeve is drawn away from the bearing's bore. (Precision and dimensions of adapter and withdrawal sleeve are defined in JIS B 1552 and JIS B 1556).

For bearings with a bore diameter of 200 mm or more, high pressure oil (hydraulic) type adapters and withdrawal sleeves can be made to make installation and disassembly easier. As shown in Fig. 3 construction is designed to reduce friction by injecting high pressure oil between the surfaces of the adapter sleeve and bearing inner bore by means of a pressure fitting.

If the oil supply inlet is attached in the nut side of the adapter, the supplementary suffix "HF" is added to the bearing number; if the oil supply inlet is attached on the opposite side, the suffix "HB" is added to the bearing number. For adapter sleeves, the supplementary suffix "H" is added to the bearing's number for both cases. The hydraulic sleeve nut is equipped with holes for bolts used for mounting and dismounting and holes for hydraulic piping. The suffix SP (with screw holes) or SPB (with bolts) is added to the bearing number of the nut.

For information on the **hydraulic adapters and withdrawal sleeves**, see the special catalog (CAT. No. 4201/E).

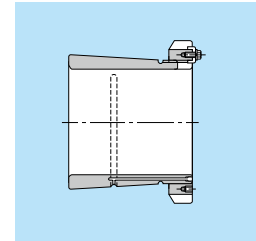
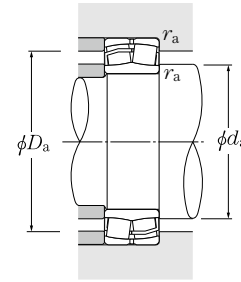
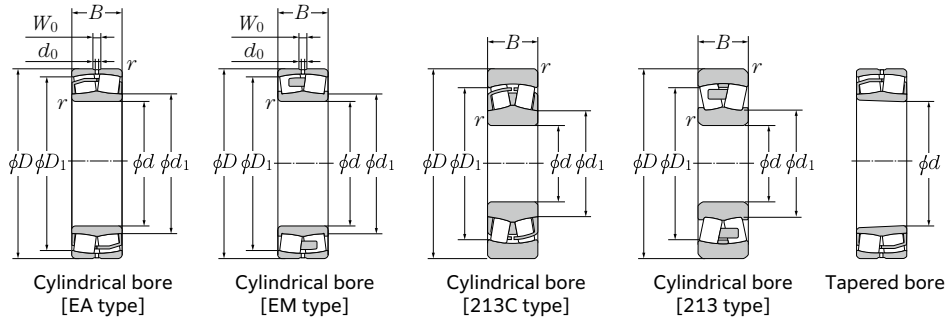

Fig. 3



Dynamic equivalent radial load
 $P_r = X F_r + Y F_a$

$\frac{F_a}{F_r} \leq e$		$\frac{F_a}{F_r} > e$	
X	Y	X	Y
1	Y ₁	0.67	Y ₂

Static equivalent radial load

$$P_{0r} = F_r + Y_0 F_a$$

For values of e , Y_1 , Y_2 and Y_0 see the table below.

d 25 ~ 60mm

d	Boundary dimensions				Basic load rating		Fatigue load limit kN C _u	Allowable speed		Bearing numbers ¹⁾	
	mm	mm	mm	mm	dynamic kN C _r	static kN C _{0r}		min ⁻¹ Grease lubrication	min ⁻¹ Oil lubrication	Cylindrical bore	Tapered bore ^{2) 4)}
25	52	18	1	3	57.3	46.1	3.23	10 400	13 000	*22205EAW33	*22205EAKW33
	52	18	1	3	57.3	46.1	3.23	10 400	13 000	*22205EMW33	*22205EMKW33
30	62	20	1	4	75.7	64.5	4.58	8 800	11 000	*22206EAW33	*22206EAKW33
	62	20	1	4	75.7	64.5	4.58	8 800	11 000	*22206EMW33	*22206EMKW33
35	72	23	1.1	5	100	92.0	6.11	7 500	9 400	*22207EAW33	*22207EAKW33
	72	23	1.1	5	100	92.0	6.11	7 500	9 400	*22207EMW33	*22207EMKW33
40	80	23	1.1	5	116	105	7.78	6 800	8 500	*22208EAD1	*22208EAKD1
	80	23	1.1	5	110	98.0	7.29	6 800	8 500	*22208EMD1	*22208EMKD1
	90	23	1.5	6	98.0	90.0	12.6	4 900	6 400	21308C	21308CK
	90	33	1.5	6	169	152	9.36	5 400	6 600	*22308EAD1	*22308EAKD1
	90	33	1.5	6	169	152	9.36	5 400	6 600	*22308EMD1	*22308EMKD1
45	85	23	1.1	6	121	113	8.76	6 100	7 700	*22209EAD1	*22209EAKD1
	85	23	1.1	6	116	106	8.24	6 100	7 700	*22209EMD1	*22209EMKD1
	100	25	1.5	6	114	106	14.1	4 400	5 700	21309C	21309CK
	100	36	1.5	6	206	187	11.8	4 600	5 700	*22309EAD1	*22309EAKD1
	100	36	1.5	6	206	187	11.8	4 600	5 700	*22309EMD1	*22309EMKD1
50	90	23	1.1	6	130	124	10.1	5 700	7 200	*22210EAD1	*22210EAKD1
	90	23	1.1	6	125	117	9.54	5 700	7 200	*22210EMD1	*22210EMKD1
	110	27	2	6	131	127	13.7	4 000	5 200	21310C	21310CK
	110	40	2	7	250	232	14.0	4 300	5 300	*22310EAD1	*22310EAKD1
	110	40	2	7	250	232	14.0	4 300	5 300	*22310EMD1	*22310EMKD1
55	100	25	1.5	6	155	148	12.6	5 300	6 700	*22211EAD1	*22211EAKD1
	100	25	1.5	6	148	140	11.9	5 300	6 700	*22211EMD1	*22211EMKD1
	120	29	2	6	161	163	16.1	3 700	4 800	21311	21311K
	120	43	2	8	296	274	17.4	3 900	4 800	*22311EAD1	*22311EAKD1
	120	43	2	8	296	274	17.4	3 900	4 800	*22311EMD1	*22311EMKD1
60	110	28	1.5	7	187	181	15.4	4 800	6 000	*22212EAD1	*22212EAKD1
	110	28	1.5	7	179	171	14.6	4 800	6 000	*22212EMD1	*22212EMKD1
	130	31	2.1	7	186	191	28.2	3 400	4 400	21312	21312K
	130	46	2.1	9	340	319	20.3	3 600	4 600	*22312EAD1	*22312EAKD1
	130	46	2.1	9	340	319	20.3	3 600	4 600	*22312EMD1	*22312EMKD1

1) Bearing part numbers with * are ULTAGE Series and have outer ring oil holes and oil grooves as standard.
 2) "K" indicates bearings having a tapered bore with a taper ratio of 1:12. 3) Smallest allowable dimension for chamfer dimension r .
 4) "W33" indicates the specification for Europe and have three oil holes.

Installation-related dimensions					Constant	Axial load factors			Mass (approx.) kg	
mm						e	Y ₁	Y ₂	Y ₀	Cylindrical bore
30	30	46	46	1	0.34	2.00	2.98	1.96	0.173	0.169
30	30	46	46	1	0.34	2.00	2.98	1.96	0.174	0.171
37	36	56	55	1	0.31	2.15	3.20	2.10	0.278	0.272
37	36	56	55	1	0.31	2.15	3.20	2.10	0.281	0.275
45	42	65	63	1.1	0.31	2.21	3.29	2.16	0.438	0.43
45	42	65	63	1.1	0.31	2.21	3.29	2.16	0.442	0.433
50	47	73	71	1.1	0.27	2.47	3.67	2.41	0.528	0.518
50	47	73	71	1.1	0.27	2.47	3.67	2.41	0.529	0.519
52	48.5	81.5	76	1.5	0.26	2.55	3.80	2.50	0.705	0.694
52	49	81	78	1.5	0.36	1.87	2.79	1.83	1.02	1
52	49	81	78	1.5	0.36	1.87	2.79	1.83	1.03	1.01
54	52	78	76	1.1	0.26	2.64	3.93	2.58	0.572	0.561
54	52	78	76	1.1	0.26	2.64	3.93	2.58	0.577	0.566
58	53.5	91.5	85	1.5	0.26	2.60	3.87	2.54	0.927	0.912
58	54	91	87	1.5	0.36	1.90	2.83	1.86	1.37	1.34
58	54	91	87	1.5	0.36	1.90	2.83	1.86	1.38	1.35
59	57	83	81	1.1	0.24	2.84	4.23	2.78	0.614	0.602
59	57	83	81	1.1	0.24	2.84	4.23	2.78	0.616	0.604
65	60	100	93	2	0.26	2.64	3.93	2.58	1.21	1.19
63	61	99	95	2	0.36	1.87	2.79	1.83	1.82	1.79
63	61	99	95	2	0.36	1.87	2.79	1.83	1.84	1.8
66	64	91	90	1.5	0.23	2.95	4.40	2.89	0.83	0.814
66	64	91	90	1.5	0.23	2.95	4.40	2.89	0.827	0.811
73	65	110	102	2	0.25	2.69	4.00	2.63	1.71	1.69
68	66	109	104	2	0.36	1.87	2.79	1.83	2.31	2.26
68	66	109	104	2	0.36	1.87	2.79	1.83	2.34	2.29
71	69	101	99	1.5	0.24	2.84	4.23	2.78	1.14	1.12
71	69	101	99	1.5	0.24	2.84	4.23	2.78	1.15	1.13
78	72	118	109	2	0.25	2.69	4.00	2.63	2.1	2.07
75	72	118	113	2.1	0.35	1.95	2.90	1.91	2.86	2.8
75	72	118	113	2.1	0.35	1.95	2.90	1.91	2.91	2.85

Note: For the bearings other than ULTAGE Series, outer rings with oil inlets and oil grooves can also be made based on your request. In this case, supplementary suffix "D1" is added after a bearing number. Example: 21311D1

Spherical Roller Bearings

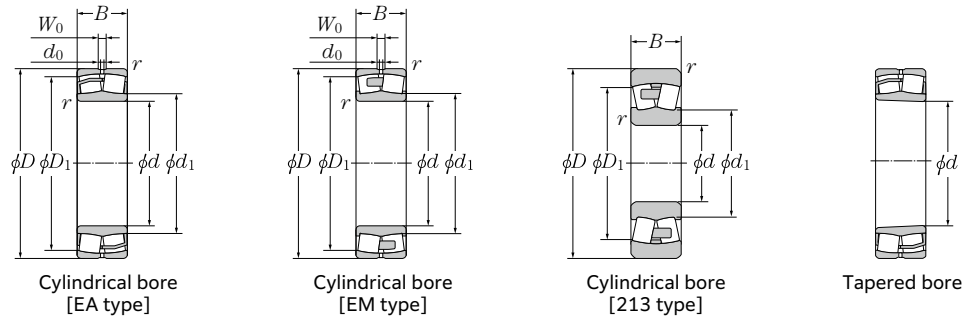

d 65 ~ 95mm

	Boundary dimensions					Basic load rating		Fatigue load limit kN C _u	Allowable speed		Bearing numbers ¹⁾	
	mm					dynamic kN C _r	static kN C _{0r}		Grease lubrication	Oil lubrication	Cylindrical bore	Tapered bore ²⁾
	d	D	B	r _{s min} ³⁾	W ₀							
65	120	31	1.5	8	3.5	226	224	18.2	4 400	5 500	*22213EAD1	*22213EAKD1
	120	31	1.5	8	3.5	217	212	17.2	4 400	5 500	*22213EMD1	*22213EMKD1
	140	33	2.1	7	4	216	228	31.0	3 100	4 000	21313	21313K
	140	48	2.1	9	4	369	343	23.4	3 300	4 100	*22313EAD1	*22313EAKD1
	140	48	2.1	9	4	369	343	23.4	3 300	4 100	*22313EMD1	*22313EMKD1
70	125	31	1.5	7	3.5	235	240	20.1	4 100	5 200	*22214EAD1	*22214EAKD1
	125	31	1.5	7	3.5	235	240	20.1	4 100	5 200	*22214EMD1	*22214EMKD1
	150	35	2.1	7	4	245	262	33.5	2 900	3 800	21314	21314K
	150	51	2.1	10	5	420	396	26.0	3 000	3 800	*22314EAD1	*22314EAKD1
	150	51	2.1	10	5	420	396	26.0	3 000	3 800	*22314EMD1	*22314EMKD1
75	130	31	1.5	7	3.5	244	249	21.1	4 000	5 000	*22215EAD1	*22215EAKD1
	130	31	1.5	7	3.5	244	249	21.1	4 000	5 000	*22215EMD1	*22215EMKD1
	160	37	2.1	7	4	266	287	27.5	2 700	3 500	21315	21315K
	160	55	2.1	10	5	491	467	29.8	2 900	3 600	*22315EAD1	*22315EAKD1
	160	55	2.1	10	5	491	467	29.8	2 900	3 600	*22315EMD1	*22315EMKD1
80	140	33	2	8	3.5	278	287	24.0	3 700	4 600	*22216EAD1	*22216EAKD1
	140	33	2	8	3.5	267	272	22.8	3 700	4 600	*22216EMD1	*22216EMKD1
	170	39	2.1	7	4	289	315	30.5	2 500	3 300	21316	21316K
	170	58	2.1	10	5	541	522	32.5	2 700	3 400	*22316EAD1	*22316EAKD1
	170	58	2.1	10	5	541	522	32.5	2 700	3 400	*22316EMD1	*22316EMKD1
85	150	36	2	8	3.5	324	330	27.1	3 400	4 300	*22217EAD1	*22217EAKD1
	150	36	2	8	3.5	324	330	27.1	3 400	4 300	*22217EMD1	*22217EMKD1
	180	41	3	7	4	320	355	45.0	2 400	3 100	21317	21317K
	180	60	3	11	5	599	604	36.4	2 600	3 200	*22317EAD1	*22317EAKD1
	180	60	3	11	5	599	604	36.4	2 600	3 200	*22317EMD1	*22317EMKD1
90	160	40	2	10	4.5	384	398	30.2	3 200	4 000	*22218EAD1	*22218EAKD1
	160	40	2	10	4.5	384	398	30.2	3 200	4 000	*22218EMD1	*22218EMKD1
	160	52.4	2	9	4	467	513	30.0	2 600	3 200	*23218EMD1	*23218EMKD1
	190	43	3	7	4	355	400	50.5	2 300	3 000	21318	21318K
	190	64	3	12	5	668	652	40.0	2 500	3 000	*22318EAD1	*22318EAKD1
95	170	43	2.1	10	4.5	416	417	33.4	3 000	3 800	*22219EAD1	*22219EAKD1
	170	43	2.1	10	4.5	416	417	33.4	3 000	3 800	*22219EMD1	*22219EMKD1

1) Bearing part numbers with * are ULTAGE Series and have outer ring oil holes and oil grooves as standard.
 2) "K" indicates bearings having a tapered bore with a taper ratio of 1:12. 3) Smallest allowable dimension for chamfer dimension r.
 B-220

Spherical Roller Bearings

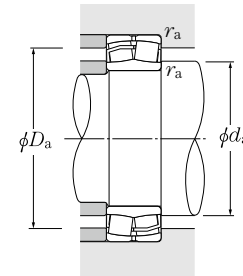

Dynamic equivalent radial load

$$P_r = X F_r + Y F_a$$

$\frac{F_a}{F_r} \leq e$		$\frac{F_a}{F_r} > e$	
X	Y	X	Y
1	Y ₁	0.67	Y ₂

Static equivalent radial load

$$P_{0r} = F_r + Y_0 F_a$$

For values of e, Y₁, Y₂ and Y₀ see the table below.

Installation-related dimensions					Constant	Axial load factors			Mass (approx.) kg	
mm						e	Y ₁	Y ₂	Y ₀	Cylindrical bore
d ₁	d _{a min}	D _{a max}	D ₁	r _{as max}						
78	74	111	107	1.5	0.24	2.79	4.15	2.73	1.52	1.49
78	74	111	107	1.5	0.24	2.79	4.15	2.73	1.53	1.5
85	77	128	119	2	0.25	2.69	4.00	2.63	2.55	2.51
81	77	128	122	2.1	0.33	2.06	3.06	2.01	3.48	3.41
81	77	128	122	2.1	0.33	2.06	3.06	2.01	3.5	3.43
84	79	116	113	1.5	0.22	3.01	4.48	2.94	1.61	1.58
84	79	116	113	1.5	0.22	3.01	4.48	2.94	1.64	1.6
91	82	138	126	2	0.25	2.69	4.00	2.63	3.18	3.14
85	82	138	131	2.1	0.34	2.00	2.98	1.96	4.25	4.16
85	82	138	131	2.1	0.34	2.00	2.98	1.96	4.31	4.22
88	84	121	118	1.5	0.22	3.14	4.67	3.07	1.67	1.64
88	84	121	118	1.5	0.22	3.14	4.67	3.07	1.71	1.67
99	87	148	136	2	0.24	2.84	4.23	2.78	3.81	3.76
91	87	148	139	2.1	0.34	2.00	2.98	1.96	5.18	5.07
91	87	148	139	2.1	0.34	2.00	2.98	1.96	5.27	5.16
94	91	129	127	2	0.22	3.14	4.67	3.07	2.09	2.05
94	91	129	127	2	0.22	3.14	4.67	3.07	2.11	2.07
105	92	158	144	2	0.23	2.95	4.40	2.89	4.53	4.47
98	92	158	148	2.1	0.34	2.00	2.98	1.96	6.12	5.99
98	92	158	148	2.1	0.34	2.00	2.98	1.96	6.28	6.15
100	96	139	137	2	0.22	3.07	4.57	3.00	2.59	2.54
100	96	139	137	2	0.22	3.07	4.57	3.00	2.67	2.62
111	99	166	152	2.5	0.25	2.69	4.00	2.63	5.35	5.28
107	99	166	157	3	0.32	2.09	3.11	2.04	7.18	7.04
107	99	166	157	3	0.32	2.09	3.11	2.04	7.29	7.15
105	101	149	144	2	0.23	2.90	4.31	2.83	3.34	3.27
105	101	149	144	2	0.23	2.90	4.31	2.83	3.43	3.37
104	101	149	141	2	0.30	2.25	3.34	2.20	4.43	4.31
119	104	176	162	2.5	0.24	2.84	4.23	2.78	6.3	6.21
110	104	176	166	3	0.33	2.06	3.06	2.01	8.42	8.25
110	104	176	166	3	0.33	2.06	3.06	2.01	8.53	8.35
110	107	158	153	2.1	0.23	2.95	4.40	2.89	3.98	3.9
110	107	158	153	2.1	0.23	2.95	4.40	2.89	4.06	3.98

Note: For the bearings other than ULTAGE Series, outer rings with oil inlets and oil grooves can also be made based on your request. In this case, supplementary suffix "D1" is added after a bearing number. Example: 21317D1

Spherical Roller Bearings

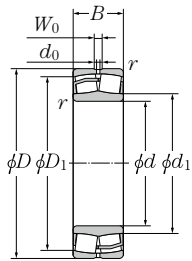

Cylindrical bore [EA type]

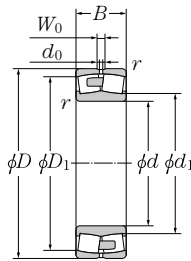

Cylindrical bore [EM type]

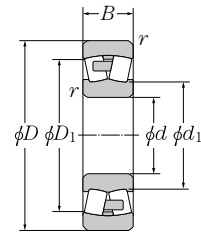

Cylindrical bore [213 type]



Tapered bore

d 95 ~ 130mm

	Boundary dimensions					Basic load rating		Fatigue load limit kN C _u	Allowable speed		Bearing numbers ¹⁾	
	mm					dynamic C _r	static C _{0r}		Grease lubrication	Oil lubrication	Cylindrical bore	Tapered bore ²⁾
	d	D	B	r _{s min} ³⁾	W ₀							
95	200	45	3	7	4	375	420	54.0	2 100	2 700	21319	21319K
	200	67	3	12	6	732	751	43.4	2 300	2 800	*22319EAD1	*22319EAKD1
	200	67	3	12	6	732	751	43.4	2 300	2 800	*22319EMD1	*22319EMKD1
100	165	52	2	8	4	464	563	30.7	2 400	3 000	*23120EAD1	*23120EAKD1
	165	52	2	8	4	480	590	32.1	2 400	3 000	*23120EMD1	*23120EMKD1
	180	46	2.1	11	5	472	495	36.9	2 800	3 600	*22220EAD1	*22220EAKD1
	180	46	2.1	11	5	472	495	36.9	2 800	3 600	*22220EMD1	*22220EMKD1
	180	60.3	2.1	9	4.5	586	661	36.3	2 300	2 900	*23220EMD1	*23220EMKD1
	215	47	3	9	5	410	465	42.5	2 000	2 600	21320	21320K
	215	73	3	13	6	827	844	50.1	2 100	2 600	*22320EAD1	*22320EAKD1
110	170	45	2	8	3.5	417	517	32.1	2 600	3 300	*23022EAD1	*23022EAKD1
	170	45	2	8	3.5	417	517	32.1	2 600	3 300	*23022EMD1	*23022EMKD1
	180	56	2	9	4	547	669	36.2	2 200	2 800	*23122EAD1	*23122EAKD1
	180	56	2	9	4	547	669	36.2	2 200	2 800	*23122EMD1	*23122EMKD1
	180	69	2	8	4	622	769	35.7	2 200	2 700	*24122EMD1	*24122EMK30D1
	200	53	2.1	12	6	602	643	45.0	2 600	3 300	*22222EAD1	*22222EAKD1
	200	53	2.1	12	6	602	643	45.0	2 600	3 300	*22222EMD1	*22222EMKD1
	200	69.8	2.1	11	5	752	869	43.9	2 100	2 600	*23222EMD1	*23222EMKD1
	240	50	3	9	5	550	615	61.5	1 800	2 300	21322	21322K
	240	80	3	16	7	975	972	59.0	2 000	2 400	*22322EAD1	*22322EAKD1
120	180	46	2	8	3.5	446	577	35.8	2 400	3 100	*23024EAD1	*23024EAKD1
	180	46	2	8	3.5	446	577	35.8	2 400	3 100	*23024EMD1	*23024EMKD1
	180	60	2	8	3.5	526	726	34.4	2 100	2 600	*24024EMD1	*24024EMK30D1
	200	62	2	10	4.5	663	820	43.4	2 000	2 500	*23124EAD1	*23124EAKD1
	200	62	2	10	4.5	663	820	43.4	2 000	2 500	*23124EMD1	*23124EMKD1
	200	80	2	10	4.5	756	991	41.3	1 900	2 500	*24124EAD1	*24124EMK30D1
	215	58	2.1	12	6	688	753	49.9	2 400	3 000	*22224EAD1	*22224EAKD1
	215	58	2.1	12	6	688	753	49.9	2 400	3 000	*22224EMD1	*22224EMKD1
	215	76	2.1	11	5	857	998	49.8	1 900	2 400	*23224EMD1	*23224EMKD1
	260	86	3	18	8	1 170	1 280	68.4	1 800	2 200	*22324EAD1	*22324EAKD1
	260	86	3	18	8	1 170	1 280	68.4	1 800	2 200	*22324EMD1	*22324EMKD1
130	200	52	2	9	4	565	721	44.2	2 200	2 900	*23026EAD1	*23026EAKD1
	200	52	2	9	4	565	721	44.2	2 200	2 900	*23026EMD1	*23026EMKD1

1) Bearing part numbers with * are ULTAGE Series and have outer ring oil holes and oil grooves as standard. 2) Bearings appended with "K" have a tapered bore ratio of 1:12; bearings appended with "K30" have a tapered bore ratio of 1:30. 3) Smallest allowable dimension for chamfer dimension r. B-222

Spherical Roller Bearings

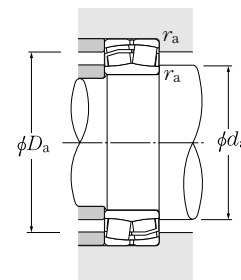

Dynamic equivalent radial load
 $P_r = X F_r + Y F_a$

$\frac{F_a}{F_r} \leq e$		$\frac{F_a}{F_r} > e$	
X	Y	X	Y
1	Y ₁	0.67	Y ₂

Static equivalent radial load
 $P_{0r} = F_r + Y_0 F_a$

For values of e, Y₁, Y₂ and Y₀ see the table below.

Installation-related dimensions					Constant	Axial load factors			Mass (approx.) kg	
mm						e	Y ₁	Y ₂	Y ₀	Cylindrical bore
d ₁	d _{a min}	D _{a max}	D ₁	r _{as max}						
127	109	186	171	2.5	0.22	3.01	4.48	2.94	7.1	7
120	109	186	174	3	0.32	2.09	3.11	2.04	9.91	9.71
120	109	186	174	3	0.32	2.09	3.11	2.04	10.0	9.82
114	111	154	147	2	0.28	2.39	3.56	2.34	4.37	4.24
114	111	154	147	2	0.28	2.39	3.56	2.34	4.45	4.32
118	112	168	161	2.1	0.24	2.84	4.23	2.78	4.9	4.8
118	112	168	161	2.1	0.24	2.84	4.23	2.78	5.02	4.93
118	112	168	159	2.1	0.31	2.18	3.24	2.13	6.51	6.33
133	114	201	179	2.5	0.22	3.01	4.48	2.94	8.89	8.78
127	114	201	187	3	0.34	1.98	2.94	1.93	12.6	12.3
127	114	201	187	3	0.34	1.98	2.94	1.93	12.9	12.7
123	119	161	155	2	0.23	2.95	4.40	2.89	3.66	3.55
123	119	161	155	2	0.23	2.95	4.40	2.89	3.66	3.55
125	121	169	161	2	0.28	2.43	3.61	2.37	5.66	5.49
125	121	169	161	2	0.28	2.43	3.61	2.37	5.53	5.36
121	121	169	158	2	0.36	1.90	2.83	1.86	6.75	6.65
130	122	188	179	2.1	0.25	2.69	4.00	2.63	7.1	6.95
130	122	188	179	2.1	0.25	2.69	4.00	2.63	7.3	7.15
130	122	188	176	2.1	0.32	2.12	3.15	2.07	9.41	9.14
146	124	226	203	2.5	0.21	3.20	4.77	3.13	11.2	11.1
139	124	226	209	3	0.32	2.09	3.11	2.04	17	16.6
139	124	226	209	3	0.32	2.09	3.11	2.04	17.4	17.1
134	129	171	165	2	0.22	3.14	4.67	3.07	4.02	3.9
134	129	171	165	2	0.22	3.14	4.67	3.07	4.02	3.9
132	129	171	161	2	0.29	2.32	3.45	2.26	5.28	5.21
138	131	189	179	2	0.28	2.43	3.61	2.37	7.72	7.49
138	131	189	179	2	0.28	2.43	3.61	2.37	7.77	7.54
136	131	189	173	2	0.37	1.84	2.74	1.80	10	9.87
141	132	203	193	2.1	0.25	2.74	4.08	2.68	8.88	8.68
141	132	203	193	2.1	0.25	2.74	4.08	2.68	9.01	8.82
139	132	203	190	2.1	0.32	2.09	3.11	2.04	11.7	11.3
156	134	246	225	3	0.32	2.09	3.11	2.04	22.3	21.9
156	134	246	225	3	0.32	2.09	3.11	2.04	22.7	22.2
145	139	191	183	2	0.22	3.01	4.48	2.94	5.88	5.71
145	139	191	183	2	0.22	3.01	4.48	2.94	5.9	5.73

Note: For the bearings other than ULTAGE Series, outer rings with oil inlets and oil grooves can also be made based on your request. In this case, supplementary suffix "D1" is added after a bearing number. Example: 21322D1

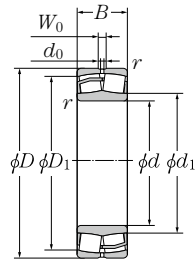

Cylindrical bore [EA type]

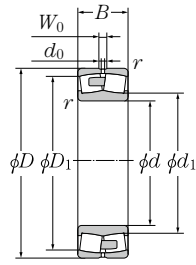

Cylindrical bore [EM type]



Tapered bore

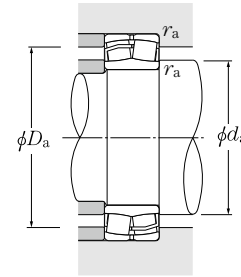

Dynamic equivalent radial load

$$P_r = X F_r + Y F_a$$

$\frac{F_a}{F_r} \leq e$		$\frac{F_a}{F_r} > e$	
X	Y	X	Y
1	Y ₁	0.67	Y ₂

Static equivalent radial load

$$P_{0r} = F_r + Y_0 F_a$$

For values of e, Y₁, Y₂ and Y₀ see the table below.

d 130 ~ 160mm

	Boundary dimensions				Basic load rating		Fatigue load limit kN C _u	Allowable speed		Bearing numbers ¹⁾	
	mm				dynamic C _r	static C _{0r}		Grease lubrication	Oil lubrication	Cylindrical bore	Tapered bore ²⁾
	d	D	B	r _{s min} ³⁾ W ₀							
130	200	69	2	9	4	682	936	42.2	1 900	2 400	*24026EMD1 *24026EMK30D1
	210	64	2	10	4.5	710	906	47.1	1 900	2 400	*23126EAD1 *23126EAKD1
	210	64	2	10	4.5	710	906	47.1	1 900	2 400	*23126EMD1 *23126EMKD1
	210	80	2	10	4.5	803	1 080	45.0	1 800	2 400	*24126EMD1 *24126EMK30D1
	230	64	3	13	6	808	898	56.6	2 200	2 800	*22226EAD1 *22226EAKD1
	230	64	3	13	6	808	898	56.6	2 200	2 800	*22226EMD1 *22226EMKD1
	230	80	3	12	5	958	1 130	55.4	1 700	2 300	*23226EMD1 *23226EMKD1
	280	93	4	19	9	1 330	1 400	77.8	1 600	2 000	*22326EAD1 *22326EAKD1
280	93	4	19	9	1 330	1 400	77.8	1 600	2 000	*22326EMD1 *22326EMKD1	
140	210	53	2	9	4	597	783	47.5	2 100	2 700	*23028EAD1 *23028EAKD1
	210	53	2	9	4	597	783	47.5	2 100	2 700	*23028EMD1 *23028EMKD1
	210	69	2	9	4	709	990	46.0	1 800	2 200	*24028EMD1 *24028EMK30D1
	225	68	2.1	11	5	802	1 030	53.1	1 800	2 200	*23128EAD1 *23128EAKD1
	225	68	2.1	11	5	802	1 030	53.1	1 800	2 200	*23128EMD1 *23128EMKD1
	225	85	2.1	10	4.5	951	1 280	53.3	1 700	2 200	*24128EMD1 *24128EMK30D1
	250	68	3	14	7	912	1 010	65.8	2 000	2 500	*22228EAD1 *22228EAKD1
	250	68	3	14	7	912	1 010	65.8	2 000	2 500	*22228EMD1 *22228EMKD1
	250	88	3	13	6	1 140	1 370	64.2	1 600	2 100	*23228EMD1 *23228EMKD1
	300	102	4	19	9	1 540	1 720	88.8	1 500	1 900	*22328EAD1 *22328EAKD1
300	102	4	19	9	1 540	1 720	88.8	1 500	1 900	*22328EMD1 *22328EMKD1	
150	225	56	2.1	10	4.5	660	893	52.9	2 000	2 500	*23030EAD1 *23030EAKD1
	225	56	2.1	10	4.5	660	893	52.9	2 000	2 500	*23030EMD1 *23030EMKD1
	225	75	2.1	10	4.5	789	1 140	51.2	1 700	2 100	*24030EMD1 *24030EMK30D1
	250	80	2.1	13	6	1 060	1 350	65.1	1 600	2 000	*23130EAD1 *23130EAKD1
	250	80	2.1	13	6	1 060	1 350	65.1	1 600	2 000	*23130EMD1 *23130EMKD1
	250	100	2.1	12	6	1 180	1 590	62.8	1 600	2 000	*24130EMD1 *24130EMK30D1
	270	73	3	15	7	1 080	1 220	74.4	1 800	2 300	*22230EAD1 *22230EAKD1
	270	73	3	15	7	1 080	1 220	74.4	1 800	2 300	*22230EMD1 *22230EMKD1
	270	96	3	14	6	1 340	1 620	74.0	1 500	1 900	*23230EMD1 *23230EMKD1
	320	108	4	20	9	1 740	1 890	98.9	1 400	1 700	*22330EMD1 *22330EMKD1
160	220	45	2	9	4	455	683	45.6	1 900	2 400	*23932EMD1 *23932EMKD1
	240	60	2.1	11	5	748	1 000	59.1	1 800	2 300	*23032EAD1 *23032EAKD1
	240	60	2.1	11	5	748	1 000	59.1	1 800	2 300	*23032EMD1 *23032EMKD1
	240	80	2.1	10	5	901	1 290	56.8	1 600	2 000	*24032EMD1 *24032EMK30D1
	270	86	2.1	14	6	1 220	1 580	73.6	1 500	1 900	*23132EAD1 *23132EAKD1
	270	86	2.1	14	6	1 220	1 580	73.6	1 500	1 900	*23132EMD1 *23132EMKD1

1) Bearing part numbers with * are ULTAGE Series and have outer ring oil holes and oil grooves as standard. 2) Bearings appended with "K" have a tapered bore ratio of 1:12; bearings appended with "K30" have a tapered bore ratio of 1:30. 3) Smallest allowable dimension for chamfer dimension r.

	Installation-related dimensions					Constant e	Axial load factors			Mass (approx.) kg	
	mm						Y ₁	Y ₂	Y ₀	Cylindrical bore	Tapered bore
	d ₁	d _{a min}	D _{a max}	D ₁	r _{as max}						
143	139	191	178	2	0.31	2.20	3.27	2.15	7.82	7.71	
148	141	199	189	2	0.27	2.51	3.74	2.45	8.45	8.19	
148	141	199	189	2	0.27	2.51	3.74	2.45	8.51	8.25	
146	141	199	183	2	0.34	1.96	2.92	1.92	10.7	10.5	
151	144	216	206	3	0.25	2.69	4.00	2.63	11	10.7	
151	144	216	206	3	0.25	2.69	4.00	2.63	11.1	10.9	
150	144	216	203	3	0.32	2.12	3.15	2.07	13.8	13.4	
164	147	263	243	4	0.33	2.06	3.06	2.01	27.2	26.6	
164	147	263	243	4	0.33	2.06	3.06	2.01	28	27.5	
155	149	201	193	2	0.22	3.14	4.67	3.07	6.32	6.13	
155	149	201	193	2	0.22	3.14	4.67	3.07	6.37	6.18	
153	149	201	188	2	0.28	2.37	3.53	2.32	8.27	8.15	
159	152	213	203	2.1	0.26	2.55	3.80	2.50	10.3	9.94	
159	152	213	203	2.1	0.26	2.55	3.80	2.50	10.3	10	
156	152	213	198	2.1	0.34	1.98	2.94	1.93	12.9	12.8	
163	154	236	224	3	0.25	2.74	4.08	2.68	13.9	13.6	
163	154	236	224	3	0.25	2.74	4.08	2.68	14.2	13.9	
162	154	236	220	3	0.33	2.06	3.06	2.01	18.2	17.7	
181	157	283	261	4	0.33	2.03	3.02	1.98	34.4	33.7	
181	157	283	261	4	0.33	2.03	3.02	1.98	35.4	34.7	
167	161	214	207	2.1	0.21	3.20	4.77	3.13	7.68	7.45	
167	161	214	207	2.1	0.21	3.20	4.77	3.13	7.73	7.5	
165	161	214	202	2.1	0.29	2.32	3.45	2.26	10.4	10.3	
171	162	238	223	2.1	0.29	2.35	3.50	2.30	15.7	15.2	
171	162	238	223	2.1	0.29	2.35	3.50	2.30	15.8	15.3	
168	162	238	216	2.1	0.36	1.85	2.76	1.81	19.7	19.4	
177	164	256	242	3	0.25	2.74	4.08	2.68	17.6	17.3	
177	164	256	242	3	0.25	2.74	4.08	2.68	18	17.7	
174	164	256	237	3	0.33	2.03	3.02	1.98	23.6	22.9	
188	167	303	279	4	0.34	2.00	2.98	1.96	42.2	41.3	
175	169	211	205	2	0.17	3.90	5.81	3.81	5.09	4.94	
177	171	229	221	2.1	0.21	3.20	4.77	3.13	9.32	9.03	
177	171	229	221	2.1	0.21	3.20	4.77	3.13	9.37	9.09	
175	171	229	215	2.1	0.29	2.32	3.45	2.26	12.6	12.4	
185	172	258	240	2.1	0.29	2.35	3.50	2.30	20.1	19.5	
185	172	258	240	2.1	0.29	2.35	3.50	2.30	20.2	19.6	

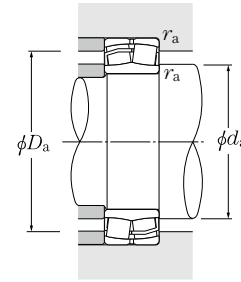
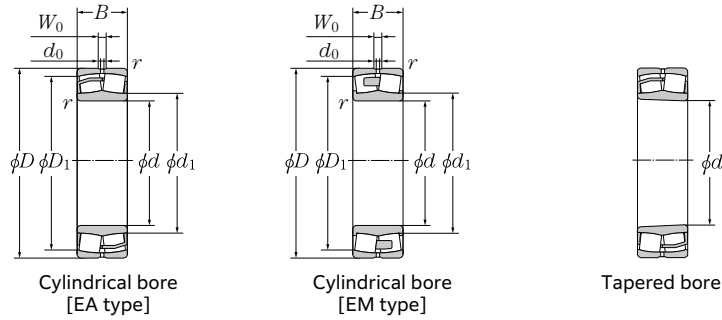

Dynamic equivalent radial load
 $P_r = X F_r + Y F_a$

$\frac{F_a}{F_r} \leq e$		$\frac{F_a}{F_r} > e$	
X	Y	X	Y
1	Y ₁	0.67	Y ₂

Static equivalent radial load

$P_{0r} = F_r + Y_0 F_a$

For values of e , Y_1 , Y_2 and Y_0 see the table below.

d 160 ~ 190mm

	Boundary dimensions					Basic load rating		Fatigue load limit kN C _u	Allowable speed		Bearing numbers ¹⁾	
	mm					dynamic kN C _r	static kN C _{0r}		Grease lubrication	Oil lubrication	Cylindrical bore	Tapered bore ²⁾
d	D	B	r _{s min} ³⁾	W ₀	d ₀							
160	270	109	2.1	14	6	1 360	1 860	70.6	1 500	1 800	*24132EMD1	*24132EMK30D1
	290	80	3	17	8	1 220	1 390	84.1	1 700	2 100	*22232EAD1	*22232EAKD1
	290	80	3	17	8	1 220	1 390	84.1	1 700	2 100	*22232EMD1	*22232EMKD1
	290	104	3	15	7	1 550	1 890	83.8	1 400	1 800	*23232EMD1	*23232EMKD1
	340	114	4	20	10	1 950	2 210	109	1 300	1 600	*22332EMD1	*22332EMKD1
170	230	45	2	9	4.5	468	723	48.8	1 800	2 300	*23934EMD1	*23934EMKD1
	260	67	2.1	12	5	914	1 240	68.8	1 700	2 200	*23034EAD1	*23034EAKD1
	260	67	2.1	12	5	914	1 240	68.8	1 700	2 200	*23034EMD1	*23034EMKD1
	260	90	2.1	11	5	1 100	1 600	66.3	1 500	1 900	*24034EMD1	*24034EMK30D1
	280	88	2.1	14	6	1 270	1 700	77.3	1 400	1 800	*23134EAD1	*23134EAKD1
	280	88	2.1	14	6	1 270	1 700	77.3	1 400	1 800	*23134EMD1	*23134EMKD1
	280	109	2.1	14	6	1 410	1 990	74.4	1 400	1 700	*24134EMD1	*24134EMK30D1
	310	86	4	18	8	1 400	1 610	94.7	1 600	2 000	*22234EMD1	*22234EMKD1
	310	110	4	16	8	1 700	2 070	94.6	1 300	1 700	*23234EMD1	*23234EMKD1
360	120	4	20	10	2 200	2 630	121	1 200	1 500	*22334EMD1	*22334EMKD1	
180	250	52	2	10	5	573	869	57.2	1 700	2 100	*23936EMD1	*23936EMKD1
	280	74	2.1	13	6	1 080	1 450	78.6	1 600	2 000	*23036EAD1	*23036EAKD1
	280	74	2.1	13	6	1 080	1 450	78.6	1 600	2 000	*23036EMD1	*23036EMKD1
	280	100	2.1	13	6	1 310	1 880	76.0	1 400	1 800	*24036EMD1	*24036EMK30D1
	300	96	3	15	7	1 490	1 960	88.7	1 300	1 700	*23136EAD1	*23136EAKD1
	300	96	3	15	7	1 490	1 960	88.7	1 300	1 700	*23136EMD1	*23136EMKD1
	300	118	3	15	7	1 660	2 290	85.5	1 300	1 600	*24136EMD1	*24136EMK30D1
	320	86	4	18	8	1 450	1 660	101	1 500	1 900	*22236EMD1	*22236EMKD1
	320	112	4	16	8	1 800	2 270	101	1 200	1 600	*23236EMD1	*23236EMKD1
380	126	4	21	10	2 420	2 810	132	1 100	1 400	*22336EMD1	*22336EMKD1	
190	260	52	2	10	5	603	935	62.8	1 600	2 000	*23938EMD1	*23938EMKD1
	290	75	2.1	13	6	1 140	1 570	83.5	1 500	1 900	*23038EAD1	*23038EAKD1
	290	75	2.1	13	6	1 140	1 570	83.5	1 500	1 900	*23038EMD1	*23038EMKD1
	290	100	2.1	13	6	1 360	2 000	80.7	1 300	1 700	*24038EMD1	*24038EMK30D1
	320	104	3	17	8	1 670	2 250	100	1 200	1 600	*23138EMD1	*23138EMKD1
	320	128	3	16	8	1 900	2 700	96.8	1 200	1 500	*24138EMD1	*24138EMK30D1
	340	92	4	20	9	1 620	1 870	112	1 400	1 800	*22238EMD1	*22238EMKD1
	340	120	4	18	8	1 990	2 480	109	1 200	1 500	*23238EMD1	*23238EMKD1
	400	132	5	21	10	2 600	3 120	145	1 000	1 300	*22338EMD1	*22338EMKD1

1) Bearing part numbers with * are ULTAGE Series and have outer ring oil holes and oil grooves as standard.
 2) Bearings appended with "K" have a tapered bore ratio of 1:12; bearings appended with "K30" have a tapered bore ratio of 1:30.
 3) Smallest allowable dimension for chamfer dimension r.

Installation-related dimensions					Constant e	Axial load factors			Mass (approx.) kg	
mm						Y ₁	Y ₂	Y ₀	Cylindrical bore	Tapered bore
d ₁	d _{a min}	D _{a max}	D ₁	r _{as max}						
181	172	258	232	2.1	0.37	1.83	2.72	1.79	25.4	25.1
190	174	276	260	3	0.25	2.69	4.00	2.63	22.3	21.8
190	174	276	260	3	0.25	2.69	4.00	2.63	22.9	22.4
187	174	276	254	3	0.33	2.03	3.02	1.98	29.6	28.8
205	177	323	296	4	0.33	2.03	3.02	1.98	50.5	49.5
185	179	221	215	2	0.16	4.11	6.12	4.02	5.39	5.23
190	181	249	238	2.1	0.22	3.07	4.57	3.00	12.7	12.3
190	181	249	238	2.1	0.22	3.07	4.57	3.00	12.8	12.4
186	181	249	231	2.1	0.30	2.23	3.32	2.18	17.2	16.9
195	182	268	250	2.1	0.28	2.39	3.56	2.34	21.5	20.9
195	182	268	250	2.1	0.28	2.39	3.56	2.34	21.6	20.9
193	182	268	243	2.1	0.35	1.91	2.85	1.87	26.7	26.3
201	187	293	277	4	0.26	2.60	3.87	2.54	28.3	27.7
199	187	293	272	4	0.33	2.03	3.02	1.98	35.8	34.8
223	187	343	313	4	0.32	2.09	3.11	2.04	60.3	59.1
199	189	241	232	2	0.17	3.90	5.81	3.81	7.79	7.56
201	191	269	255	2.1	0.23	2.95	4.40	2.89	16.8	16.3
201	191	269	255	2.1	0.23	2.95	4.40	2.89	16.9	16.4
199	191	269	248	2.1	0.31	2.15	3.20	2.10	22.8	22.4
205	194	286	267	3	0.29	2.32	3.45	2.26	27.2	26.4
205	194	286	267	3	0.29	2.32	3.45	2.26	27.4	26.5
202	194	286	259	3	0.36	1.87	2.79	1.83	33.5	33
209	197	303	287	4	0.25	2.74	4.08	2.68	29.3	28.7
210	197	303	282	4	0.33	2.06	3.06	2.01	38.2	37.1
229	197	363	329	4	0.32	2.09	3.11	2.04	70.2	68.7
209	199	251	243	2	0.17	4.05	6.04	3.96	8.2	7.96
213	201	279	266	2.1	0.22	3.01	4.48	2.94	17.8	17.3
213	201	279	266	2.1	0.22	3.01	4.48	2.94	17.9	17.4
209	201	279	258	2.1	0.30	2.23	3.32	2.18	23.8	23.4
221	204	306	284	3	0.29	2.32	3.45	2.26	34.3	33.2
216	204	306	275	3	0.37	1.84	2.74	1.80	42.1	41.5
222	207	323	305	4	0.25	2.74	4.08	2.68	35.6	34.9
220	207	323	299	4	0.33	2.03	3.02	1.98	46.1	44.7
247	210	380	346	5	0.32	2.12	3.15	2.07	81.5	79.9

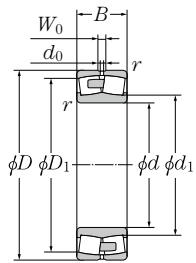

Cylindrical bore
[EM type]

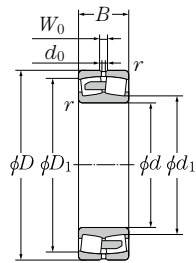

Cylindrical bore
[EM type (large size)]



Tapered bore

d 200 ~ 280mm

d	Boundary dimensions					Basic load rating		Fatigue load limit kN C _u	Allowable speed		Bearing numbers ¹⁾	
	mm					dynamic kN C _r	static C _{0r}		Grease lubrication	min ⁻¹ Oil lubrication	Cylindrical bore	Tapered bore ²⁾
	D	B	r _{s min} ³⁾	W ₀	d ₀							
200	280	60	2.1	12	6	766	1 190	71.8	1 500	1 900	*23940EMD1	*23940EMKD1
	310	82	2.1	15	7	1 310	1 790	94.1	1 400	1 800	*23040EMD1	*23040EMKD1
	310	109	2.1	14	7	1 570	2 280	91.1	1 200	1 600	*24040EMD1	*24040EMK30D1
	340	112	3	18	8	1 890	2 510	110	1 100	1 400	*23140EMD1	*23140EMKD1
	340	140	3	17	8	2 130	2 930	105	1 100	1 400	*24140EMD1	*24140EMK30D1
	360	98	4	20	10	1 810	2 100	124	1 400	1 700	*22240EMD1	*22240EMKD1
	360	128	4	19	9	2 250	2 840	120	1 100	1 300	*23240EMD1	*23240EMKD1
420	138	5	21	10	2 830	3 530	158	950	1 200	*22340EMD1	*22340EMKD1	
220	300	60	2.1	12	6	789	1 260	79.4	1 400	1 700	*23944EMD1	*23944EMKD1
	340	90	3	15	7	1 530	2 110	109	1 300	1 600	*23044EMD1	*23044EMKD1
	340	118	3	15	7	1 850	2 720	106	1 100	1 400	*24044EMD1	*24044EMK30D1
	370	120	4	19	9	2 190	2 940	128	1 000	1 300	*23144EMD1	*23144EMKD1
	370	150	4	19	9	2 540	3 620	124	1 000	1 300	*24144EMD1	*24144EMK30D1
	400	108	4	21	11	2 210	2 690	149	1 200	1 500	*22244EMD1	*22244EMKD1
	400	144	4	20	10	2 890	3 830	147	1 000	1 200	*23244EMD1	*23244EMKD1
460	145	5	20	12	3 010	3 560	163	850	1 090	*22344EMD1	*22344EMKD1	
240	320	60	2.1	12	6	815	1 350	87.7	1 300	1 600	*23948EMD1	*23948EMKD1
	360	92	3	16	8	1 630	2 350	120	1 100	1 400	*23048EMD1	*23048EMKD1
	360	118	3	16	8	1 940	2 980	116	1 000	1 300	*24048EMD1	*24048EMK30D1
	400	128	4	20	9	2 510	3 500	147	960	1 200	*23148EMD1	*23148EMKD1
	400	160	4	19	9	2 910	4 290	142	960	1 200	*24148EMD1	*24148EMK30D1
	440	120	4	16	10	2 470	3 110	159	1 060	1 350	*22248EMD1	*22248EMKD1
	440	160	4	20	12	3 140	4 260	156	850	1 090	*23248EMD1	*23248EMKD1
500	155	5	20	12	3 500	4 170	193	780	1 000	*22348EMD1	*22348EMKD1	
260	360	75	2.1	14	7	1 130	1 940	105	1 100	1 400	*23952EMD1	*23952EMKD1
	400	104	4	18	8	2 060	2 910	144	1 000	1 300	*23052EMD1	*23052EMKD1
	400	140	4	18	8	2 520	3 820	139	960	1 200	*24052EMD1	*24052EMK30D1
	440	144	4	20	12	2 780	4 020	160	860	1 090	*23152EMD1	*23152EMKD1
	440	180	4	27	16	3 290	4 880	147	850	1 090	*24152EMD1	*24152EMK30D1
	480	130	5	20	12	2 890	3 680	183	970	1 240	*22252EMD1	*22252EMKD1
	480	174	5	27	16	3 650	5 050	180	780	1 000	*23252EMD1	*23252EMKD1
540	165	6	27	16	4 020	4 830	221	720	920	*22352EMD1	*22352EMKD1	
280	380	75	2.1	14	7	1 180	2 050	115	1 000	1 300	*23956EMD1	*23956EMKD1
	420	106	4	18	8	2 170	3 150	155	960	1 200	*23056EMD1	*23056EMKD1

1) Bearing part numbers with * are ULTAGE Series and have outer ring oil holes and oil grooves as standard. Bearing models having outer diameter *D* dimension of 440 mm or more are the EM type (large size). 2) Bearings appended with "K" have a tapered bore ratio of 1:12; bearings appended with "K30" have a tapered bore ratio of 1:30. 3) Smallest allowable dimension for chamfer dimension *r*.

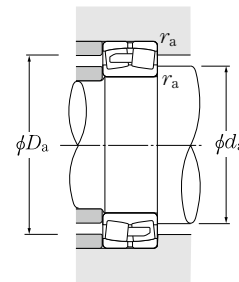

Dynamic equivalent radial load

$$P_r = X F_r + Y F_a$$

$\frac{F_a}{F_r} \leq e$		$\frac{F_a}{F_r} > e$	
X	Y	X	Y
1	Y ₁	0.67	Y ₂

Static equivalent radial load

$$P_{0r} = F_r + Y_0 F_a$$

For values of *e*, *Y*₁, *Y*₂ and *Y*₀ see the table below.

Installation-related dimensions					Constant	Axial load factors			Mass (approx.) kg	
mm						<i>e</i>	<i>Y</i> ₁	<i>Y</i> ₂	<i>Y</i> ₀	Cylindrical bore
<i>d</i> ₁	<i>d</i> _{a min}	<i>D</i> _{a max}	<i>D</i> ₁	<i>r</i> _{as max}						
221	211	269	260	2.1	0.18	3.76	5.59	3.67	12	11.6
223	211	299	283	2.1	0.23	2.95	4.40	2.89	22.8	22.1
221	211	299	275	2.1	0.31	2.18	3.24	2.13	30.2	29.7
231	214	326	301	3	0.30	2.25	3.34	2.20	41.9	40.6
224	214	326	291	3	0.39	1.74	2.59	1.70	51.5	50.7
234	217	343	323	4	0.25	2.74	4.08	2.68	42.7	41.8
232	217	343	315	4	0.34	1.98	2.94	1.93	55.2	53.6
265	220	400	364	5	0.31	2.15	3.20	2.10	94.6	92.7
241	231	289	280	2.1	0.17	4.05	6.04	3.96	12.5	12.1
246	233	327	310	3	0.23	2.95	4.40	2.89	29.9	29.1
243	233	327	302	3	0.31	2.20	3.27	2.15	39.2	38.6
252	237	353	328	4	0.30	2.28	3.39	2.23	52.3	50.7
247	237	353	317	4	0.38	1.78	2.65	1.74	65.2	64.3
264	237	383	358	4	0.25	2.74	4.08	2.68	59.6	58.4
261	237	383	349	4	0.34	2.00	2.98	1.96	79.4	77.1
277	240	440	388	5	0.32	2.10	3.13	2.06	119	116
262	251	309	301	2.1	0.15	4.40	6.56	4.31	13.5	13.1
267	253	347	329	3	0.22	3.07	4.57	3.00	32	31.7
264	253	347	322	3	0.28	2.37	3.53	2.32	42.2	41.6
276	257	383	356	4	0.29	2.32	3.45	2.26	65.1	63.1
270	257	383	344	4	0.37	1.82	2.70	1.78	81	79.8
288	257	423	383	4	0.27	2.53	3.77	2.47	82.6	80.9
284	257	423	372	4	0.36	1.86	2.77	1.82	108	105
299	260	480	421	5	0.32	2.12	3.15	2.07	149	146
292	271	349	335	2.1	0.17	3.90	5.81	3.81	23.9	23.1
291	275	385	366	4	0.23	2.95	4.40	2.89	47.8	46.3
286	275	385	354	4	0.31	2.16	3.22	2.12	63.6	62.6
302	277	423	380	4	0.31	2.15	3.20	2.10	92.2	89.5
295	277	423	371	4	0.40	1.69	2.52	1.65	111	109
312	280	460	415	5	0.27	2.53	3.77	2.47	108	105
310	280	460	405	5	0.36	1.87	2.79	1.83	143	139
324	286	514	456	6	0.31	2.16	3.22	2.12	186	183
310	291	369	356	2.1	0.16	4.16	6.20	4.07	25.2	24.4
310	295	405	386	4	0.22	3.07	4.57	3.00	51.3	49.7

Spherical Roller Bearings

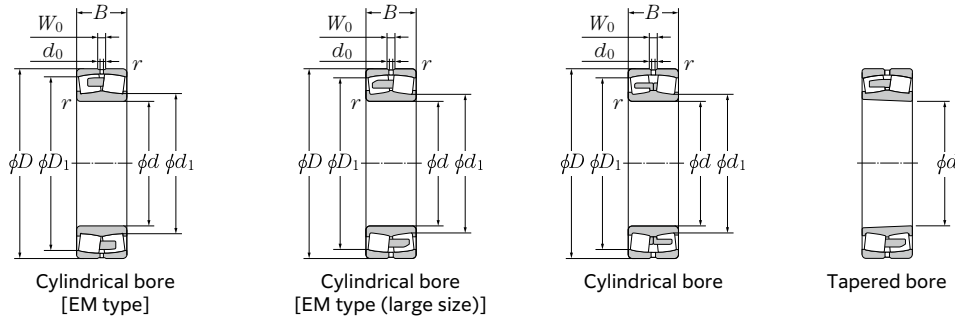

a 280 ~ 360mm

	Boundary dimensions					Basic load rating		Fatigue load limit kN C_u	Allowable speed			Bearing numbers ¹⁾		
	mm					dynamic kN C_r	static C_{0r}		Grease lubrication	min ⁻¹ Oil lubrication	Cylindrical bore	Tapered bore ²⁾		
	d	D	B	$r_{s\min}^3)$	W_0								d_0	
280	420	140	4	18	8	2 620	4 060	150	880	1 100	*24056EMD1	*24056EMK30D1		
	460	146	5	20	12	2 980	4 400	182	810	1 030	*23156EMD1	*23156EMKD1		
	460	180	5	27	16	3 550	5 450	167	810	1 030	*24156EMD1	*24156EMK30D1		
	500	130	5	20	12	3 010	3 920	198	920	1 180	*22256EMD1	*22256EMKD1		
	500	176	5	27	16	3 810	5 420	193	740	950	*23256EMD1	*23256EMKD1		
	580	175	6	27	16	4 490	5 450	249	670	860	*22356EMD1	*22356EMKD1		
300	420	90	3	14	8	1 600	2 620	145	890	1 140	*23960EMD1	*23960EMKD1		
	460	118	4	16	10	2 400	3 610	176	890	1 130	*23060EMD1	*23060EMKD1		
	460	160	4	20	12	3 150	5 190	166	760	970	*24060EMD1	*24060EMK30D1		
	500	160	5	20	12	3 540	5 170	205	750	950	*23160EMD1	*23160EMKD1		
	500	200	5	27	16	4 270	6 610	198	750	950	*24160EMD1	*24160EMK30D1		
	540	140	5	20	12	3 470	4 590	232	860	1 080	*22260EMD1	*22260EMKD1		
	540	192	5	27	16	4 520	6 280	228	690	880	*23260EMD1	*23260EMKD1		
	620	185	7.5	27	16	4 000	5 400	490	550	720	22360B	22360BK		
320	440	90	3	14	8	1 670	2 820	154	840	1 080	*23964EMD1	*23964EMKD1		
	480	121	4	20	12	2 540	4 020	191	850	1 070	*23064EMD1	*23064EMKD1		
	480	160	4	20	12	3 250	5 400	184	720	920	*24064EMD1	*24064EMK30D1		
	540	176	5	27	16	4 020	6 020	227	700	880	*23164EMD1	*23164EMKD1		
	540	210	5	33	20	5 010	7 720	225	690	880	*24164EMD1	*24164EMK30D1		
	580	150	5	20	12	3 950	5 100	261	800	1 020	*22264EMD1	*22264EMKD1		
	580	208	5	33	20	5 230	7 370	259	640	820	*23264EMD1	*23264EMKD1		
340	460	90	3	14	8	1 710	2 980	162	800	1 020	*23968EMD1	*23968EMKD1		
	520	133	5	20	12	2 990	4 690	219	790	1 000	*23068EMD1	*23068EMKD1		
	520	180	5	27	16	3 910	6 510	206	670	860	*24068EMD1	*24068EMK30D1		
	580	190	5	27	16	4 670	6 870	257	650	830	*23168EMD1	*23168EMKD1		
	580	243	5	33	20	5 980	9 340	254	650	830	*24168EMD1	*24168EMK30D1		
	620	224	6	33	20	4 950	8 000	585	490	630	23268B	23268BK		
	360	480	90	3	14	8	1 750	3 090	171	760	970	*23972EMD1	*23972EMKD1	
540		134	5	20	12	3 070	4 910	232	750	950	*23072EMD1	*23072EMKD1		
540		180	5	27	16	4 040	6 840	220	640	820	*24072EMD1	*24072EMK30D1		
600		192	5	27	16	4 200	7 050	530	490	630	23172B	23172BK		
600		243	5	33	20	5 100	9 150	470	490	630	24172B	24172BK30		
650		232	6	33	20	5 400	8 700	620	450	590	23272B	23272BK		

1) Bearing part numbers with * are ULTAGE Series and have outer ring oil holes and oil grooves as standard. Bearing models having outer diameter D dimension of 440 mm or more are the EM type (large size). 2) Bearings appended with "K" have a tapered bore ratio of 1:12; bearings appended with "K30" have a tapered bore ratio of 1:30. 3) Smallest allowable dimension for chamfer dimension r .

Spherical Roller Bearings

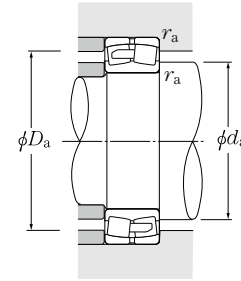

Dynamic equivalent radial load
 $P_r = X F_r + Y F_a$

$\frac{F_a}{F_r} \leq e$		$\frac{F_a}{F_r} > e$	
X	Y	X	Y
1	Y_1	0.67	Y_2

Static equivalent radial load

$$P_{0r} = F_r + Y_0 F_a$$

For values of e , Y_1 , Y_2 and Y_0 see the table below.

Installation-related dimensions					Constant e	Axial load factors			Mass (approx.) kg	
mm						Y_1	Y_2	Y_0	Cylindrical bore	Tapered bore
d_1	$d_{a\min}$	$D_{a\max}$	D_1	$r_{as\max}$						
306	295	405	376	4	0.29	2.30	3.42	2.25	67.3	66.3
322	300	440	403	5	0.30	2.23	3.32	2.18	98.4	95.3
316	300	440	394	5	0.38	1.78	2.65	1.74	118	117
333	300	480	437	5	0.25	2.69	4.00	2.63	113	111
331	300	480	426	5	0.35	1.95	2.90	1.91	152	148
349	306	554	489	6	0.31	2.18	3.24	2.13	228	223
329	313	407	387	3	0.20	3.42	5.09	3.34	40.1	39.2
338	315	445	413	4	0.24	2.81	4.19	2.75	72.9	70.9
332	315	445	401	4	0.33	2.04	3.04	2.00	98.0	96.9
345	320	480	436	5	0.31	2.20	3.27	2.15	129	125
340	320	480	425	5	0.39	1.74	2.59	1.70	159	157
358	320	520	469	5	0.25	2.69	4.00	2.63	134	131
352	320	520	461	5	0.35	1.92	2.86	1.88	194	188
381	336	584	522	6	0.32	2.13	3.17	2.08	270	265
350	333	427	407	3	0.19	3.62	5.39	3.54	42.1	40.8
360	335	465	433	4	0.23	2.92	4.35	2.86	78.9	76.6
352	335	465	423	4	0.31	2.15	3.20	2.10	104	102
373	340	520	468	5	0.31	2.15	3.20	2.10	169	164
363	340	520	457	5	0.39	1.71	2.54	1.67	204	201
383	340	560	510	5	0.25	2.69	4.00	2.63	177	174
376	340	560	493	5	0.35	1.91	2.85	1.87	245	238
370	353	447	427	3	0.18	3.80	5.66	3.72	44.5	43.1
384	358	502	466	5	0.24	2.87	4.27	2.80	98.5	95.5
377	358	502	456	5	0.33	2.06	3.06	2.01	140	137
393	360	560	500	5	0.32	2.12	3.15	2.07	213	206
385	360	560	486	5	0.41	1.65	2.46	1.61	266	262
435	368	592	598	5	0.37	1.84	2.75	1.80	300	291
390	373	467	447	3	0.17	4.00	5.96	3.91	46.2	44.8
405	378	522	488	5	0.23	2.98	4.44	2.92	111	108
398	378	522	478	5	0.31	2.16	3.22	2.12	147	145
417	382	578	520	4	0.32	2.11	3.15	2.07	222	215
414	382	578	507	4	0.40	1.67	2.48	1.63	281	277
429	388	622	551	5	0.36	1.87	2.78	1.83	339	329

Note: Bearings other than the ULTAGE Series with outer diameter D dimension of 320 mm or more are also provided with outer ring oil inlets and oil grooves.

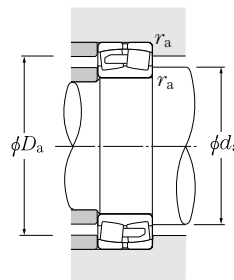
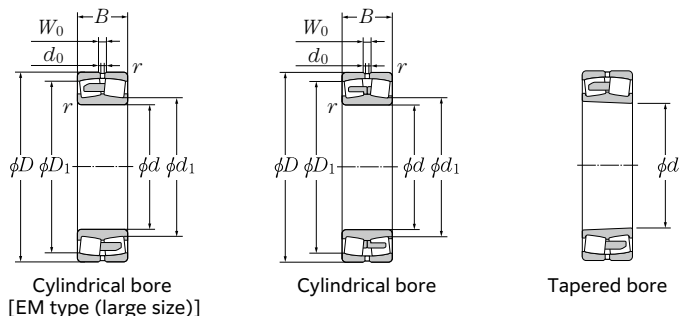

Dynamic equivalent radial load
 $P_r = X F_r + Y F_a$

$\frac{F_a}{F_r} \leq e$		$\frac{F_a}{F_r} > e$	
X	Y	X	Y
1	Y ₁	0.67	Y ₂

Static equivalent radial load

$$P_{0r} = F_r + Y_0 F_a$$

For values of e , Y_1 , Y_2 and Y_0 see the table below.

d 380 ~ 480mm

d	Boundary dimensions					Basic load rating		Fatigue load limit kN C _u	Allowable speed		Bearing numbers ¹⁾	
	D	B	r _{s min} ³⁾	W ₀	d ₀	dynamic C _r	static C _{0r}		Grease lubrication	Oil lubrication	Cylindrical bore	Tapered bore ²⁾
380	520	106	4	16	10	2 300	3 920	205	710	910	*23976EMD1	*23976EMKD1
	560	135	5	20	12	3 230	5 270	247	720	910	*23076EMD1	*23076EMKD1
	560	180	5	27	16	4 140	7 280	240	610	780	*24076EMD1	*24076EMK30D1
	620	194	5	27	16	4 350	7 500	560	450	590	23176B	23176BK
	620	243	5	33	20	5 350	9 650	570	450	590	24176B	24176BK30
	680	240	6	33	20	5 800	9 650	665	430	550	23276B	23276BK
400	540	106	4	16	10	2 370	4 170	215	680	870	*23980EMD1	*23980EMKD1
	600	148	5	20	12	3 300	6 050	450	520	680	23080B	23080BK
	600	200	5	27	16	4 250	8 400	485	460	600	24080B	24080BK30
	650	200	6	27	16	4 650	8 050	630	430	560	23180B	23180BK
	650	250	6	33	20	5 650	10 300	585	430	560	24180B	24180BK30
	720	256	6	33	20	6 500	10 600	740	400	520	23280B	23280BK
420	560	106	4	16	10	2 390	4 320	230	650	830	*23984EMD1	*23984EMKD1
	620	150	5	20	12	3 450	6 400	475	490	640	23084B	23084BK
	620	200	5	27	16	4 300	8 450	470	440	570	24084B	24084BK30
	700	224	6	33	20	5 800	9 950	680	410	530	23184B	23184BK
	700	280	6	33	20	6 850	12 200	755	410	530	24184B	24184BK30
	760	272	7.5	33	20	7 300	12 000	820	380	490	23284B	23284BK
440	600	118	4	16	10	2 260	4 700	325	500	650	23988	23988K
	650	157	6	20	12	3 650	6 850	530	470	610	23088B	23088BK
	650	212	6	33	20	4 800	9 450	530	420	540	24088B	24088BK30
	720	226	6	33	20	5 800	10 100	685	390	500	23188B	23188BK
	720	280	6	33	20	7 200	13 100	715	390	500	24188B	24188BK30
	790	280	7.5	33	20	7 700	12 800	870	360	470	23288B	23288BK
460	620	118	4	16	10	2 340	4 950	325	480	620	23992	23992K
	680	163	6	27	16	4 000	7 450	560	450	580	23092B	23092BK
	680	218	6	33	20	5 100	10 200	590	390	510	24092B	24092BK30
	760	240	7.5	33	20	6 350	11 400	775	360	470	23192B	23192BK
	760	300	7.5	33	20	7 900	14 500	805	360	470	24192B	24192BK30
	830	296	7.5	33	20	8 650	14 500	925	340	440	23292B	23292BK
480	650	128	5	20	12	2 590	5 500	365	450	590	23996	23996K
	700	165	6	27	16	4 050	7 700	570	420	550	23096B	23096BK
	700	218	6	33	20	5 200	10 500	610	380	490	24096B	24096BK30

1) Bearing part numbers with * are the ULTAGE Series EM type (large size) and have outer ring oil holes and oil grooves as standard.
 2) Bearings appended with "K" have a tapered bore ratio of 1:12; bearings appended with "K30" have a tapered bore ratio of 1:30.
 3) Smallest allowable dimension for chamfer dimension r.

Installation-related dimensions					Constant e	Axial load factors			Mass (approx.) kg	
d ₁	d _{a min}	D _{a max}	D ₁	r _{as max}		Y ₁	Y ₂	Y ₀	Cylindrical bore	Tapered bore
412	395	505	481	4	0.18	3.66	5.46	3.58	68.0	65.9
425	398	542	509	5	0.22	3.07	4.57	3.00	117	113
420	398	542	499	5	0.30	2.25	3.34	2.20	154	151
436	402	598	540	4	0.31	2.16	3.22	2.12	235	228
431	402	598	529	4	0.39	1.73	2.58	1.69	292	287
453	408	652	575	5	0.36	1.89	2.82	1.85	380	369
433	415	525	501	4	0.18	3.80	5.66	3.72	71.4	69.2
451	422	578	542	4	0.24	2.80	4.16	2.73	149	144
446	422	578	528	4	0.32	2.09	3.11	2.04	202	200
458	428	622	567	5	0.31	2.21	3.29	2.16	264	256
453	428	622	552	5	0.38	1.77	2.63	1.73	329	324
473	428	692	612	5	0.37	1.81	2.69	1.77	457	443
454	435	545	522	4	0.17	3.95	5.88	3.86	74.9	72.6
471	442	598	562	4	0.24	2.85	4.24	2.79	157	152
465	442	598	551	4	0.32	2.13	3.17	2.08	210	207
488	448	672	611	5	0.32	2.11	3.15	2.07	354	343
477	448	672	592	5	0.40	1.69	2.51	1.65	440	433
501	456	724	643	6	0.36	1.86	2.77	1.82	544	528
483	458	582	551	3	0.18	3.66	5.46	3.58	101	98
490	468	622	585	5	0.24	2.85	4.24	2.79	181	175
486	468	622	576	5	0.32	2.11	3.15	2.07	245	241
504	468	692	627	5	0.31	2.15	3.21	2.11	370	358
498	468	692	614	5	0.39	1.75	2.61	1.71	456	449
525	476	754	671	6	0.36	1.88	2.80	1.84	600	582
503	478	602	572	3	0.17	3.95	5.88	3.86	107	104
512	488	652	613	5	0.23	2.88	4.29	2.82	206	200
509	488	652	604	5	0.31	2.15	3.21	2.11	276	272
534	496	724	660	6	0.31	2.14	3.19	2.10	443	429
523	496	724	645	6	0.39	1.71	2.55	1.67	550	541
547	496	794	703	6	0.36	1.87	2.78	1.83	704	683
527	502	628	599	4	0.18	3.85	5.73	3.76	123	119
532	508	672	633	5	0.23	2.94	4.38	2.88	217	209
530	508	672	625	5	0.30	2.22	3.30	2.17	285	280

Note: Outer ring oil inlets/oil grooves are provided.

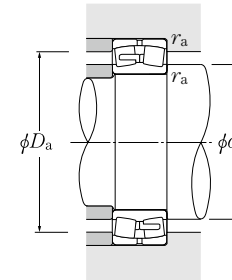
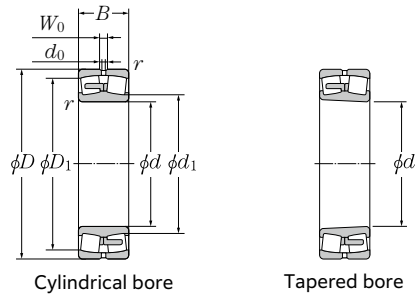

Dynamic equivalent radial load

$$P_r = X F_r + Y F_a$$

$\frac{F_a}{F_r} \leq e$		$\frac{F_a}{F_r} > e$	
X	Y	X	Y
1	Y ₁	0.67	Y ₂

Static equivalent radial load

$$P_{0r} = F_r + Y_0 F_a$$

For values of e , Y_1 , Y_2 and Y_0 see the table below.

d 480 ~ 630mm

d	Boundary dimensions					Basic load rating		Fatigue load limit C _u	Allowable speed		Bearing numbers	
	mm					dynamic C _r	static C _{0r}		Grease lubrication	min ⁻¹ Oil lubrication	Cylindrical bore	Tapered bore ¹⁾
	D	B	r _{s min} ²⁾	W ₀	d ₀							
480	790	248	7.5	33	20	6 900	12 300	860	350	450	23196B	23196BK
	790	308	7.5	33	20	8 250	15 300	860	350	450	24196B	24196BK30
	870	310	7.5	33	20	9 200	15 500	1 000	320	420	23296B	23296BK
500	670	128	5	20	12	2 640	5 600	460	430	560	239/500	239/500K
	720	167	6	27	16	4 250	8 300	645	410	530	230/500B	230/500BK
	720	218	6	33	20	5 300	10 900	640	350	460	240/500B	240/500BK30
	830	264	7.5	33	20	7 700	13 700	875	330	430	231/500B	231/500BK
	830	325	7.5	42	25	9 000	16 700	870	330	430	241/500B	241/500BK30
	920	336	7.5	42	25	10 500	17 800	1 100	310	400	232/500B	232/500BK
530	710	136	5	20	12	2 940	6 450	400	400	520	239/530	239/530K
	780	185	6	27	16	4 850	9 350	710	380	490	230/530B	230/530BK
	780	250	6	33	20	6 200	12 700	700	330	430	240/530B	240/530BK30
	870	272	7.5	33	20	7 800	14 200	920	310	400	231/530B	231/530BK
	870	335	7.5	42	25	9 250	17 400	910	310	400	241/530B	241/530BK30
	980	355	9.5	42	25	11 500	19 800	1 210	280	370	232/530B	232/530BK
560	750	140	5	20	12	3 200	6 900	525	380	490	239/560	239/560K
	820	195	6	27	16	5 350	10 500	800	350	450	230/560B	230/560BK
	820	258	6	33	20	6 750	14 100	750	310	400	240/560B	240/560BK30
	920	280	7.5	33	20	8 550	15 500	1 000	280	370	231/560B	231/560BK
	920	355	7.5	42	25	11 100	20 800	1 030	280	370	241/560B	241/560BK30
	1 030	365	9.5	42	25	12 300	21 100	1 320	260	340	232/560B	232/560BK
600	800	150	5	20	12	3 600	8 000	490	350	450	239/600	239/600K
	870	200	6	27	16	5 800	12 000	835	310	420	230/600B	230/600BK
	870	272	6	33	20	7 150	15 600	750	280	370	240/600B	240/600BK30
	980	300	7.5	33	20	10 000	18 400	1 160	260	340	231/600B	231/600BK
	980	375	7.5	42	25	11 900	23 200	1 130	260	340	241/600B	241/600BK30
	1 090	388	9.5	42	25	13 600	23 700	930	250	320	232/600B	232/600BK
630	850	165	6	27	16	4 100	9 250	545	320	420	239/630	239/630K
	920	212	7.5	33	20	6 550	13 000	950	310	400	230/630B	230/630BK
	920	290	7.5	33	20	8 400	17 900	915	270	350	240/630B	240/630BK30
	1 030	315	7.5	33	20	10 700	19 900	1 190	250	320	231/630B	231/630BK
	1 030	400	7.5	42	25	12 900	25 000	1 200	250	320	241/630B	241/630BK30
	1 150	412	12	42	25	15 200	26 800	1 540	230	300	232/630B	232/630BK

1) Bearings appended with "K" have a tapered bore ratio of 1:12; bearings appended with "K30" have a tapered bore ratio of 1:30.
2) Smallest allowable dimension for chamfer dimension r .

Installation-related dimensions					Constant	Axial load factors			Mass (approx.) kg	
mm						e	Y ₁	Y ₂	Y ₀	Cylindrical bore
d ₁	d _{a min}	D _{a max}	D ₁	r _{as max}						
554	516	754	687	6	0.31	2.15	3.21	2.11	492	477
546	516	754	671	6	0.39	1.74	2.59	1.70	608	600
574	516	834	737	6	0.36	1.87	2.78	1.83	814	790
547	522	648	621	4	0.17	4.02	5.98	3.93	131	127
552	528	692	653	5	0.23	2.98	4.44	2.92	226	218
550	528	692	646	5	0.30	2.28	3.40	2.23	295	290
580	536	794	724	6	0.32	2.12	3.16	2.08	584	566
572	536	794	703	6	0.39	1.72	2.57	1.69	716	705
600	536	884	773	6	0.39	1.74	2.59	1.70	1 000	971
579	552	688	654	4	0.17	3.95	5.88	3.86	157	152
594	558	752	704	5	0.22	3.03	4.52	2.97	306	295
586	558	752	689	5	0.30	2.24	3.33	2.19	413	406
617	566	834	757	6	0.30	2.22	3.30	2.17	653	633
605	566	834	737	6	0.38	1.79	2.67	1.75	800	788
600	574	936	723	8	0.39	1.74	2.59	1.70	1 200	1 170
547	582	728	621	4	0.16	4.10	6.10	4.01	182	176
627	588	792	741	5	0.22	3.03	4.51	2.96	353	340
620	588	792	726	5	0.30	2.29	3.40	2.24	467	459
650	596	884	801	6	0.30	2.27	3.38	2.22	752	729
638	596	884	787	6	0.39	1.75	2.61	1.71	948	934
677	604	986	867	8	0.36	1.88	2.80	1.84	1 360	1 320
654	622	778	739	4	0.18	3.85	5.73	3.76	218	211
672	628	842	785	5	0.21	3.17	4.72	3.10	400	386
667	628	842	770	5	0.29	2.33	3.47	2.28	544	535
694	636	944	860	6	0.30	2.22	3.30	2.17	908	880
685	636	944	832	6	0.37	1.81	2.70	1.77	1 130	1 110
722	644	1 046	919	8	0.36	1.86	2.77	1.82	1 540	1 490
690	658	822	781	5	0.18	3.66	5.46	3.58	277	268
704	666	884	834	6	0.22	3.14	4.67	3.07	481	464
697	666	884	815	6	0.30	2.28	3.40	2.23	657	646
731	666	994	899	6	0.30	2.27	3.38	2.22	1 050	1 020
718	666	994	872	6	0.38	1.78	2.66	1.74	1 330	1 310
760	684	1 096	969	10	0.36	1.87	2.78	1.83	1 900	1 840

Note: Outer ring oil inlets/oil grooves are provided.

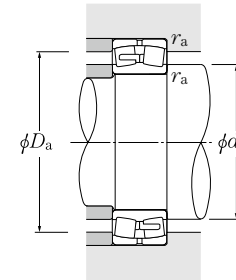
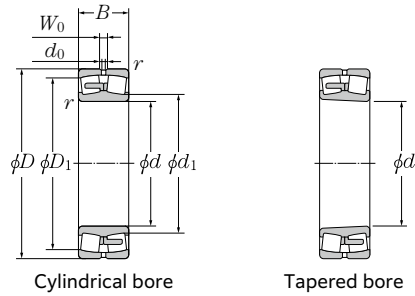

Dynamic equivalent radial load

$$P_r = X F_r + Y F_a$$

$\frac{F_a}{F_r} \leq e$		$\frac{F_a}{F_r} > e$	
X	Y	X	Y
1	Y ₁	0.67	Y ₂

Static equivalent radial load

$$P_{0r} = F_r + Y_0 F_a$$

For values of e , Y_1 , Y_2 and Y_0 see the table below.

d 670 ~ 950mm

	Boundary dimensions					Basic load rating		Fatigue load limit	Allowable speed		Bearing numbers	
	mm					dynamic	static		Grease	Oil	Cylindrical bore	Tapered bore ¹⁾
	d	D	B	r _{s min} ²⁾	W ₀	d ₀	C _r	C _{0r}	C _u	min ⁻¹		
670	900	170	6	27	16	4 550	10 300	795	300	390	239/670	239/670K
	980	230	7.5	33	20	7 300	14 600	1 000	280	360	230/670B	230/670BK
	980	308	7.5	33	20	9 650	20 600	1 040	250	320	240/670B	240/670BK30
	1 090	336	7.5	42	25	12 500	23 600	1 400	230	300	231/670B	231/670BK
	1 090	412	7.5	42	25	14 100	28 000	1 340	230	300	241/670B	241/670BK30
	1 220	438	12	42	25	17 900	32 000	1 770	220	280	232/670B	232/670BK
710	950	180	6	27	16	4 950	11 500	665	280	370	239/710	239/710K
	1 030	236	7.5	33	20	8 000	16 200	1 140	260	340	230/710B	230/710BK
	1 030	315	7.5	33	20	10 300	22 500	1 150	230	300	240/710B	240/710BK30
	1 150	345	9.5	42	25	13 000	24 900	1 470	220	280	231/710B	231/710BK
	1 150	438	9.5	42	25	16 100	32 000	1 190	220	280	241/710B	241/710BK30
	1 280	450	12	42	25	18 100	32 500	1 200	200	260	232/710B	232/710BK
750	1 000	185	6	27	16	5 600	13 000	990	260	340	239/750	239/750K
	1 090	250	7.5	33	20	9 100	18 300	1 290	250	320	230/750B	230/750BK
	1 090	335	7.5	42	25	11 300	24 600	1 230	220	280	240/750B	240/750BK30
	1 220	365	9.5	42	25	14 300	27 200	1 130	200	260	231/750B	231/750BK
	1 360	475	15	42	25	20 300	36 500	1 980	180	240	232/750B	232/750BK
800	1 060	195	6	27	16	6 000	13 700	1 040	240	310	239/800	239/800K
	1 150	258	7.5	33	20	9 350	19 500	1 340	220	290	230/800B	230/800BK
	1 150	345	7.5	42	25	12 400	27 800	1 360	200	260	240/800B	240/800BK30
	1 280	375	9.5	42	25	16 000	31 000	1 780	180	240	231/800B	231/800BK
850	1 120	200	6	27	16	6 500	15 100	1 080	220	290	239/850	239/850K
	1 220	272	7.5	33	20	10 900	22 700	1 510	210	270	230/850B	230/850BK
	1 220	365	7.5	42	25	13 900	31 500	1 490	180	240	240/850B	240/850BK30
	1 360	400	12	42	25	17 300	34 000	1 380	170	220	231/850B	231/850BK
900	1 180	206	6	33	20	7 400	17 300	1 230	210	270	239/900	239/900K
	1 280	280	7.5	33	20	11 400	24 700	1 580	190	250	230/900B	230/900BK
	1 280	375	7.5	42	25	14 700	33 500	1 580	170	220	240/900B	240/900BK30
	1 420	412	12	42	25	18 700	38 000	2 030	150	200	231/900B	231/900BK
950	1 250	224	7.5	33	20	8 650	20 500	1 390	190	250	239/950	239/950K
	1 360	300	7.5	33	20	12 800	28 400	1 750	180	230	230/950B	230/950BK
	1 360	412	7.5	42	25	17 200	40 000	1 780	160	210	240/950B	240/950BK30

1) Bearings appended with "K" have a tapered bore ratio of 1:12; bearings appended with "K30" have a tapered bore ratio of 1:30.
2) Smallest allowable dimension for chamfer dimension r.

Installation-related dimensions					Constant	Axial load factors			Mass (approx.) kg	
mm						e	Y ₁	Y ₂	Y ₀	Cylindrical bore
d ₁	d _{a min}	D _{a max}	D ₁	r _{as max}						
733	698	872	830	5	0.18	3.76	5.59	3.67	317	307
750	706	944	886	6	0.22	3.07	4.57	3.00	594	573
741	706	944	870	6	0.29	2.29	3.41	2.24	794	781
773	706	1 054	956	6	0.30	2.22	3.30	2.17	1 250	1 210
764	706	1 054	926	6	0.37	1.83	2.73	1.79	1 530	1 510
807	724	1 166	1 034	10	0.36	1.89	2.81	1.85	2 270	2 200
778	738	922	876	5	0.18	3.85	5.73	3.76	375	363
792	746	994	937	6	0.22	3.02	4.50	2.96	663	640
783	746	994	916	6	0.29	2.36	3.51	2.31	884	870
822	754	1 106	1 005	8	0.29	2.32	3.45	2.27	1 420	1 380
805	754	1 106	979	8	0.37	1.83	2.72	1.79	1 800	1 770
851	764	1 226	1 081	10	0.35	1.91	2.84	1.87	2 540	2 470
818	778	972	924	5	0.17	3.90	5.81	3.81	412	399
834	786	1 054	991	6	0.21	3.20	4.76	3.13	790	763
828	786	1 054	969	6	0.29	2.35	3.49	2.29	1 060	1 040
868	794	1 176	1 066	8	0.29	2.32	3.45	2.27	1 700	1 650
903	814	1 296	1 149	12	0.35	1.92	2.86	1.88	3 050	2 960
868	828	1 032	983	5	0.17	4.05	6.04	3.96	487	471
893	836	1 114	1 049	6	0.21	3.15	4.69	3.08	890	859
881	836	1 114	1 026	6	0.28	2.41	3.59	2.36	1 190	1 170
912	844	1 236	1 122	8	0.29	2.32	3.45	2.27	1 890	1 830
924	878	1 092	1 043	5	0.16	4.25	6.32	4.15	550	532
945	886	1 184	1 114	6	0.20	3.32	4.95	3.25	1 050	1 010
936	886	1 184	1 089	6	0.28	2.42	3.61	2.37	1 410	1 390
979	904	1 306	1 194	10	0.28	2.37	3.54	2.32	2 270	2 200
974	928	1 152	1 101	5	0.16	4.32	6.44	4.23	623	603
999	936	1 244	1 167	6	0.20	3.32	4.95	3.25	1 170	1 130
988	936	1 244	1 147	6	0.27	2.48	3.70	2.43	1 570	1 540
1 031	954	1 366	1 251	10	0.28	2.42	3.60	2.36	2 500	2 420
1 029	986	1 214	1 165	6	0.16	4.20	6.26	4.11	774	749
1 063	986	1 324	1 239	6	0.21	3.26	4.85	3.18	1 430	1 380
1 044	986	1 324	1 213	6	0.28	2.39	3.56	2.34	1 970	1 940

Note: Outer ring oil inlets/oil grooves are provided.

Spherical Roller Bearings

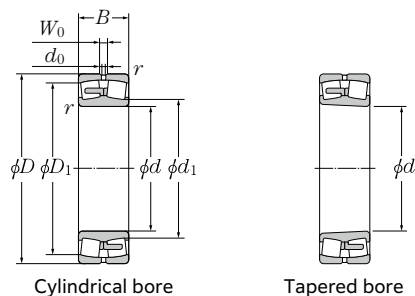

Cylindrical bore

Tapered bore

d 1000 ~ 1400mm

	Boundary dimensions					Basic load rating		Fatigue load limit kN C _u	Allowable speed		Bearing numbers	
	mm					dynamic kN C _r	static kN C _{0r}		Grease lubrication	Oil lubrication	Cylindrical bore	Tapered bore ¹⁾
d	D	B	r _{s min} ²⁾	W ₀	d ₀							
1000	1 320	236	7.5	33	20	9 550	22 700	1 520	180	230	239/1000	239/1000K
	1 420	308	7.5	33	20	13 800	30 000	1 460	170	220	230/1000B	230/1000BK
	1 420	412	7.5	42	25	17 800	42 000	1 890	150	190	240/1000B	240/1000BK30
1060	1 400	250	7.5	33	20	10 400	24 700	1 670	160	210	239/1060	239/1060K
	1 500	325	9.5	42	25	15 100	33 500	1 610	150	200	230/1060B	230/1060BK
	1 500	438	9.5	42	25	19 800	47 000	2 060	140	180	240/1060B	240/1060BK30
1120	1 460	250	7.5	33	20	10 900	26 700	1 470	150	200	239/1120	239/1120K
	1 580	345	9.5	42	25	17 400	39 000	2 310	150	190	230/1120B	230/1120BK
	1 580	462	9.5	42	25	21 700	52 500	2 230	120	160	240/1120B	240/1120BK30
1180	1 540	272	7.5	33	20	12 200	29 800	1 650	140	180	239/1180	239/1180K
1250	1 630	280	7.5	33	20	13 400	33 500	1 810	120	160	239/1250	239/1250K
1320	1 720	300	7.5	33	20	15 100	38 000	1 930	120	150	239/1320	239/1320K
1400	1 820	315	9.5	33	20	16 800	43 000	2 570	100	130	239/1400	239/1400K

1) Bearings appended with "K" have a tapered bore ratio of 1:12; bearings appended with "K30" have a tapered bore ratio of 1:30.
2) Smallest allowable dimension for chamfer dimension r.

Spherical Roller Bearings

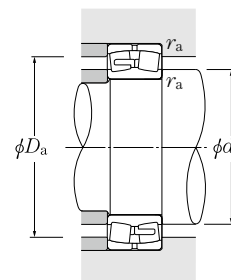

Dynamic equivalent radial load

$$P_r = X F_r + Y F_a$$

$\frac{F_a}{F_r} \leq e$		$\frac{F_a}{F_r} > e$	
X	Y	X	Y
1	Y ₁	0.67	Y ₂

Static equivalent radial load

$$P_{0r} = F_r + Y_0 F_a$$

For values of e, Y₁, Y₂ and Y₀ see the table below.

Installation-related dimensions					Constant	Axial load factors			Mass (approx.) kg	
mm						e	Y ₁	Y ₂	Y ₀	Cylindrical bore
d ₁	d _{a min}	D _{a max}	D ₁	r _{as max}						
1 084	1 036	1 284	1 230	6	0.16	4.21	6.26	4.11	916	887
1 107	1 036	1 384	1 294	6	0.20	3.37	5.02	3.29	1 580	1 520
1 097	1 036	1 384	1 272	6	0.27	2.51	3.73	2.45	2 110	2 080
1 153	1 096	1 364	1 400	6	0.16	4.20	6.26	4.11	1 090	1 060
1 172	1 104	1 456	1 368	8	0.20	3.36	5.00	3.28	1 850	1 790
1 160	1 104	1 456	1 343	8	0.27	2.49	3.71	2.44	2 450	2 140
1 208	1 156	1 424	1 362	6	0.15	4.42	6.58	4.32	1 140	1 100
1 234	1 164	1 536	1 442	8	0.21	3.19	4.75	3.12	2 160	2 090
1 227	1 164	1 536	1 418	8	0.27	2.50	3.72	2.44	2 890	2 840
1 271	1 216	1 504	1 437	6	0.15	4.40	6.56	4.31	1 390	1 340
1 352	1 286	1 594	1 525	6	0.15	4.42	6.58	4.32	1 600	1 550
1 423	1 356	1 684	1 605	6	0.16	4.34	6.46	4.24	1 900	1 840
1 513	1 444	1 776	1 703	8	0.15	4.39	6.54	4.29	2 230	2 160

Note: Outer ring oil inlets/oil grooves are provided.

Adapters



(For spherical roller bearings)

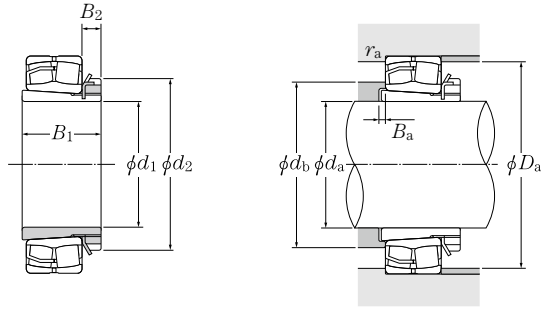

d_1 35 ~ 70mm

	Boundary dimensions				Numbers ¹⁾		Installation-related dimensions					Mass ²⁾
	mm				Bearing	Adapter	d_a	d_b	B_a	mm		kg
d_1	B_1	d_2	B_2			Min.	Max.	Min.	Min.	Max.	r_{as}	(approx.)
35	36	58	10	* 22208EAKD1;H 308X		44	50	5	71	73	1.1	0.189
	36	58	10	21308CK;H 308X		44	52	5	76	81.5	1.5	0.189
	46	58	10	* 22308EAKD1;H2308X		45	52	5	78	81	1.5	0.224
40	39	65	11	* 22209EAKD1;H 309X		49	54	8	76	78	1.1	0.248
	39	65	11	21309CK;H 309X		49	57	5	85	91.5	1.5	0.248
	50	65	11	* 22309EAKD1;H2309X		50	58	5	87	91	1.5	0.280
45	42	70	12	* 22210EAKD1;H 310X		54	59	10	81	83	1.1	0.303
	42	70	12	21310CK;H 310X		54	65	5	93	100	2	0.303
	55	70	12	* 22310EAKD1;H2310X		56	63	5	95	99	2	0.362
50	45	75	12	* 22211EAKD1;H 311X		60	66	11	90	91	1.5	0.345
	45	75	12	21311K;H 311X		60	73	6	102	110	2	0.345
	59	75	12	* 22311EAKD1;H2311X		61	68	6	104	109	2	0.420
55	47	80	13	* 22212EAKD1;H 312X		65	71	9	99	101	1.5	0.394
	47	80	13	21312K;H 312X		65	78	5	109	118	2	0.394
	62	80	13	* 22312EAKD1;H2312X		66	75	5	113	118	2.1	0.481
60	50	85	14	* 22213EAKD1;H 313X		70	78	8	107	111	1.5	0.458
	50	85	14	21313K;H 313X		70	85	5	119	128	2	0.458
	65	85	14	* 22313EAKD1;H2313X		72	81	5	122	128	2.1	0.557
65	55	98	15	* 22215EAKD1;H 315X		80	88	12	118	121	1.5	0.831
	55	98	15	21315K;H 315X		80	99	5	136	148	2	0.831
	73	98	15	* 22315EAKD1;H2315X		82	91	5	139	148	2.1	1.05
70	59	105	17	* 22216EAKD1;H 316X		86	94	12	127	129	2	1.03
	59	105	17	21316K;H 316X		86	105	5	144	158	2	1.03
	78	105	17	* 22316EAKD1;H2316X		87	98	5	148	158	2.1	1.28

1) Bearing numbers marked "*" designate ULTAGE Series. 2) Indicates the adapter mass.
 Note: 1. Refer to pages B-218 to B-221 for bearing dimensions, rated loads, and mass.
 2. Refer to pages D-2 to D-10 and D-12 to D-14 for adapter locknut and washer dimensions.
 3. Adapter numbers which are appended with the code "X" indicate narrow slit type adapters which use washers with straight inner tabs.

Adapters



(For spherical roller bearings)

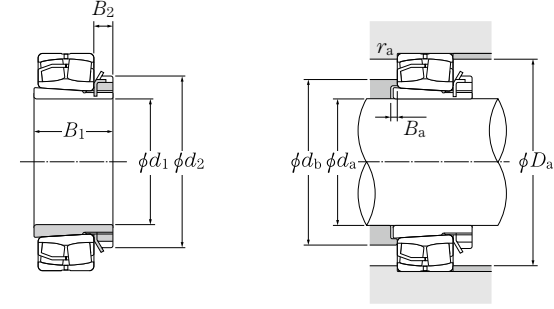

d_1 75 ~ 115mm

	Boundary dimensions				Numbers ¹⁾		Installation-related dimensions					Mass ²⁾
	mm				Bearing	Adapter	d_a	d_b	B_a	mm		kg
d_1	B_1	d_2	B_2			Min.	Max.	Min.	Min.	Max.	r_{as}	(approx.)
75	63	110	18	* 22217EAKD1;H 317X		91	100	12	137	139	2	1.18
	63	110	18	21317K;H 317X		91	111	6	152	166	2.5	1.18
	82	110	18	* 22317EAKD1;H2317X		94	107	6	157	166	3	1.45
80	65	120	18	* 22218EAKD1;H 318X		96	105	10	144	149	2	1.37
	86	120	18	* 23218EMKD1;H2318X		99	104	18	141	149	2	1.69
	65	120	18	21318K;H 318X		96	119	6	162	176	2.5	1.37
	86	120	18	* 22318EAKD1;H2318X		99	110	6	166	176	3	1.69
85	68	125	19	* 22219EAKD1;H 319X		102	110	9	153	158	2.1	1.56
	68	125	19	21319K;H 319X		102	127	7	171	186	2.5	1.56
	90	125	19	* 22319EAKD1;H2319X		105	120	7	174	186	3	1.92
90	71	130	20	* 22220EAKD1;H 320X		107	118	8	161	168	2.1	1.69
	97	130	20	* 23220EMKD1;H2320X		110	118	19	159	168	2.1	2.15
	71	130	20	21320K;H 320X		107	133	7	179	201	2.5	1.69
	97	130	20	* 22320EAKD1;H2320X		110	127	7	187	201	3	2.15
100	81	145	21	* 23122EAKD1;H3122X		117	125	7	161	169	2	2.25
	77	145	21	* 22222EAKD1;H 322X		117	130	6	179	188	2.1	2.18
	105	145	21	* 23222EMKD1;H2322X		121	130	17	176	188	2.1	2.74
	77	145	21	21322K;H 322X		117	146	9	203	226	2.5	2.18
	105	145	21	* 22322EAKD1;H2322X		121	139	7	209	226	3	2.74
110	72	145	22	* 23024EAKD1;H3024X		127	134	7	165	171	2	1.93
	88	155	22	* 23124EAKD1;H3124X		128	138	7	179	189	2	2.64
	88	155	22	* 22224EAKD1;H2324X		128	141	11	193	203	2.1	2.64
	112	155	22	* 23224EMKD1;H2324X		131	139	17	190	203	2.1	3.19
	112	155	22	* 22324EAKD1;H2324X		131	156	7	225	246	3	3.19
115	80	155	23	* 23026EAKD1;H3026		137	145	8	183	191	2	2.85
	92	165	23	* 23126EAKD1;H3126		138	148	8	189	199	2	3.66
	92	165	23	* 22226EAKD1;H2326		138	151	8	206	216	3	3.66
	121	165	23	* 23226EMKD1;H2326		142	150	21	203	216	3	4.6
	121	165	23	* 22326EAKD1;H2326		142	164	8	243	263	4	4.6

1) Bearing numbers marked "*" designate ULTAGE Series. 2) Indicates the adapter mass.
 Note: 1. Refer to pages B-220 to B-225 for bearing dimensions, rated loads, and mass.
 2. Refer to pages D-2 to D-10 and D-12 to D-14 for adapter locknut and washer dimensions.
 3. Adapter numbers which are appended with the code "X" indicate narrow slit type adapters which use washers with straight inner tabs.

Adapters



(For spherical roller bearings)

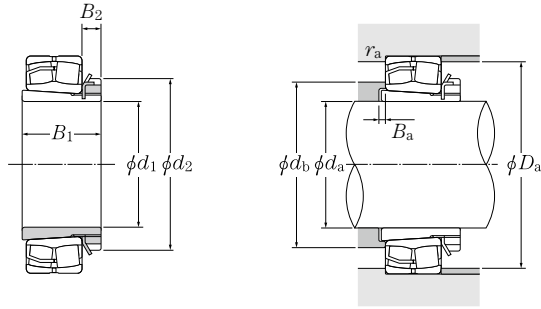

d_1 125 ~ 170mm

	Boundary dimensions				Numbers ¹⁾		Installation-related dimensions						Mass ²⁾
	mm				Bearing	Adapter	d_a	d_b	B_a	mm		r_{as}	kg
	d_1	B_1	d_2	B_2			Min.	Max.	Min.	Min.	Max.	Max.	(approx.)
125	82	165	24		*	23028EAKD1;H3028	147	155	8	193	201	2	3.16
	97	180	24		*	23128EAKD1;H3128	149	159	8	203	213	2.1	4.34
	97	180	24		*	22228EAKD1;H3128	149	163	8	224	236	3	4.34
	131	180	24		*	23228EMKD1;H2328	152	162	22	220	236	3	5.55
	131	180	24		*	22328EAKD1;H2328	152	181	8	261	283	4	5.55
135	87	180	26		*	23030EAKD1;H3030	158	167	8	207	214	2.1	3.89
	111	195	26		*	23130EAKD1;H3130	160	171	8	223	238	2.1	5.52
	111	195	26		*	22230EAKD1;H3130	160	177	15	242	256	3	5.52
	139	195	26		*	23230EMKD1;H2330	163	174	20	237	256	3	6.63
	139	195	26		*	22330EMKD1;H2330	163	188	8	279	303	4	6.63
140	93	190	28		*	23032EAKD1;H3032	168	177	8	221	229	2.1	5.21
	119	210	28		*	23132EAKD1;H3132	170	185	8	240	258	2.1	7.67
	119	210	28		*	22232EAKD1;H3132	170	190	14	260	276	3	7.67
	147	210	28		*	23232EMKD1;H2332	174	187	18	254	276	3	9.14
	147	210	28		*	22332EMKD1;H2332	174	205	8	296	323	4	9.14
150	101	200	29		*	23034EAKD1;H3034	179	190	8	238	249	2.1	5.99
	122	220	29		*	23134EAKD1;H3134	180	195	8	250	268	2.1	8.38
	122	220	29		*	22234EAKD1;H3134	180	201	10	277	293	4	8.38
	154	220	29		*	23234EMKD1;H2334	185	199	18	272	293	4	10.2
	154	220	29		*	22334EMKD1;H2334	185	223	8	313	343	4	10.2
160	109	210	30		*	23036EAKD1;H3036	189	201	8	255	269	2.1	6.83
	131	230	30		*	23136EAKD1;H3136	191	205	8	267	286	3	9.5
	131	230	30		*	22236EMKD1;H3136	191	209	18	287	303	4	9.5
	161	230	30		*	23236EMKD1;H2336	195	210	22	282	303	4	11.3
	161	230	30		*	22336EMKD1;H2336	195	229	8	329	363	4	11.3
170	112	220	31		*	23038EAKD1;H3038	199	213	9	266	279	2.1	7.45
	141	240	31		*	23138EMKD1;H3138	202	221	9	284	306	3	10.8
	141	240	31		*	22238EMKD1;H3138	202	222	21	305	323	4	10.8
	169	240	31		*	23238EMKD1;H2338	206	220	21	299	323	4	12.6
	169	240	31		*	22338EMKD1;H2338	206	247	9	346	380	5	12.6

1) Bearing numbers marked "*" designate ULTAGE Series. 2) Indicates the adapter mass.

Note: 1. Refer to pages B-224 to B-227 for bearing dimensions, rated loads, and mass.

2. Refer to pages D-2 to D-10 and D-12 to D-14 for adapter locknut and washer dimensions.

Adapters



(For spherical roller bearings)

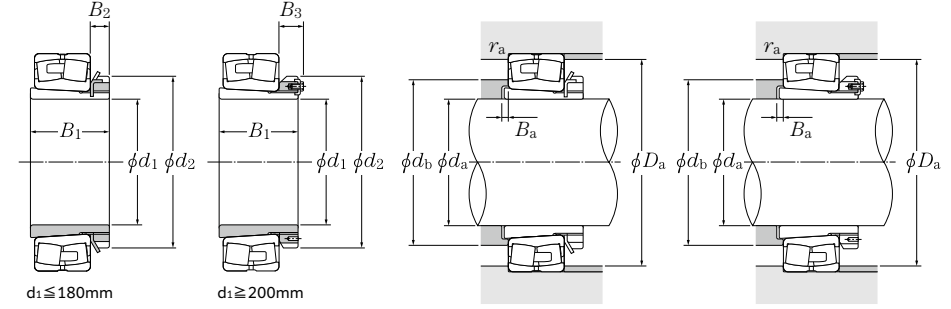

$d_1 \leq 180$ mm

$d_1 \geq 200$ mm

d_1 180 ~ 300mm

	Boundary dimensions				Numbers ¹⁾		Installation-related dimensions						Mass ²⁾	
	mm				Bearing	Adapter	d_a	d_b	B_a	mm		D_a	r_{as}	kg
	d_1	B_1	d_2	B_2			Min.	Max.	Min.	Min.	Max.	Max.	Max.	(approx.)
180	120	240	32	-	*	23040EMKD1;H3040	210	223	10	283	299	2.1	9.19	
	150	250	32	-	*	23140EMKD1;H3140	212	231	10	301	326	3	12.1	
	150	250	32	-	*	22240EMKD1;H3140	212	234	24	323	343	4	12.1	
	176	250	32	-	*	23240EMKD1;H2340	216	232	20	315	343	4	13.9	
	176	250	32	-	*	22340EMKD1;H2340	216	265	10	364	400	5	13.9	
200	126	260	-	41	*	23044EMKD1;H3044	231	246	12	310	327	3	10.3	
	158	280	-	44	*	23144EMKD1;H3144	233	252	10	328	353	4	14.7	
	158	280	-	44	*	22244EMKD1;H3144	233	264	22	358	383	4	14.7	
	183	280	-	44	*	23244EMKD1;H2344	236	261	11	349	383	4	16.7	
	183	280	-	44	*	22344EMKD1;H2344	236	277	10	388	440	5	16.7	
220	133	290	-	46	*	23048EMKD1;H3048	251	267	11	329	347	3	13.2	
	169	300	-	46	*	23148EMKD1;H3148	254	276	11	356	383	4	17.3	
	169	300	-	46	*	22248EMKD1;H3148	254	288	19	383	423	4	17.3	
	196	300	-	46	*	23248EMKD1;H2348	257	284	6	372	423	4	19.7	
	196	300	-	46	*	22348EMKD1;H2348	257	299	11	421	480	5	19.7	
240	145	310	-	46	*	23052EMKD1;H3052	272	291	13	366	385	4	15.3	
	187	330	-	49	*	23152EMKD1;H3152	276	302	11	380	423	4	22	
	187	330	-	49	*	22252EMKD1;H3152	276	312	25	415	460	5	22	
	208	330	-	49	*	23252EMKD1;H2352	278	310	2	405	460	5	24.2	
	208	330	-	49	*	22352EMKD1;H2352	278	324	11	456	514	6	24.2	
260	152	330	-	50	*	23056EMKD1;H3056	292	310	12	386	405	4	17.7	
	192	350	-	51	*	23156EMKD1;H3156	296	322	12	403	440	5	24.5	
	192	350	-	51	*	22256EMKD1;H3156	296	333	28	437	480	5	24.5	
	221	350	-	51	*	23256EMKD1;H2356	299	331	11	426	480	5	27.8	
	221	350	-	51	*	22356EMKD1;H2356	299	349	12	489	554	6	27.8	
280	168	360	-	54	*	23060EMKD1;H3060	313	338	12	413	445	4	22.8	
	208	380	-	53	*	23160EMKD1;H3160	317	345	12	436	480	5	30.2	
	208	380	-	53	*	22260EMKD1;H3160	317	358	32	469	520	5	30.2	
	240	380	-	53	*	23260EMKD1;H2360	321	352	12	461	520	5	34.1	
	300	171	380	-	55	*	23064EMKD1;H3064	334	360	13	433	465	4	24.6
226		400	-	56	*	23164EMKD1;H3164	339	373	13	468	520	5	34.9	
226		400	-	56	*	22264EMKD1;H3164	339	383	39	510	560	5	34.9	

1) Bearing numbers marked "*" designate ULTAGE Series. 2) Indicates the adapter mass.

Note: 1. Refer to pages B-228 to B-231 for bearing dimensions, rated loads, and mass.

2. Refer to pages D-2 to D-10 and D-12 to D-14 for adapter locknut, washer, and lockplate dimensions.

Adapters

(For spherical roller bearings)

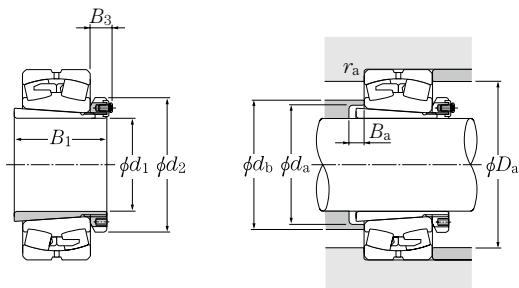

d₁ 300 ~ 470mm

Boundary dimensions	Numbers ¹⁾		Installation-related dimensions					Mass ²⁾				
	mm		mm						kg			
d ₁	B ₁	d ₂	B ₂	Bearing	Adapter	d _a	d _b	B _a	D _a	r _{as}	(approx.)	
300	258	400	56	*	23264EMKD1;H3264	343	376	13	493	560	5	39.3
320	187	400	58	*	23068EMKD1;H3068	355	384	14	466	502	5	28.7
	254	440	72	*	23168EMKD1;H3168	360	393	14	500	560	5	49.5
	288	440	72		23268BK;H3268	364	410	14	524	592	5	54.6
340	188	420	58	*	23072EMKD1;H3072	375	405	14	488	522	5	30.5
	259	460	75		23172BK;H3172	380	417	14	520	578	4	54.2
	299	460	75		23272BK;H3272	385	429	14	551	622	5	60.2
360	193	450	62	*	23076EMKD1;H3076	396	425	15	509	542	5	35.8
	264	490	77		23176BK;H3176	401	436	15	540	598	4	61.7
	310	490	77		23276BK;H3276	405	453	15	575	652	5	69.6
380	210	470	66		23080BK;H3080	417	451	15	542	578	4	41.3
	272	520	82		23180BK;H3180	421	458	15	568	622	5	70.6
	328	520	82		23280BK;H3280	427	473	15	612	692	5	81
400	212	490	66		23084BK;H3084	437	471	16	562	598	4	43.7
	304	540	90		23184BK;H3184	443	488	16	611	672	5	84.2
410	228	520	77		23088BK;H3088	458	490	17	585	622	5	65.2
	307	560	90		23188BK;H3188	464	504	17	627	692	5	104
430	234	540	77		23092BK;H3092	478	512	17	613	652	5	69.5
	326	580	95		23192BK;H3192	485	534	17	660	724	6	116
450	237	560	77		23096BK;H3096	499	532	18	633	672	5	73.3
	335	620	95		23196BK;H3196	505	554	18	687	754	6	133
470	247	580	85		230/500BK;H30/500	519	552	18	653	692	5	81.8
	356	630	100		231/500BK;H31/500	527	580	18	724	794	6	143

1) Bearing numbers marked "*" designate ULTAGE Series. 2) Indicates the adapter mass.

Note: 1. Refer to pages B-230 to B-235 for bearing dimensions, rated loads, and mass.

2. Refer to pages D-2 to D-10 and D-12 to D-14 for adapter locknut and lockplate dimensions.

Withdrawal Sleeves

(For spherical roller bearings)

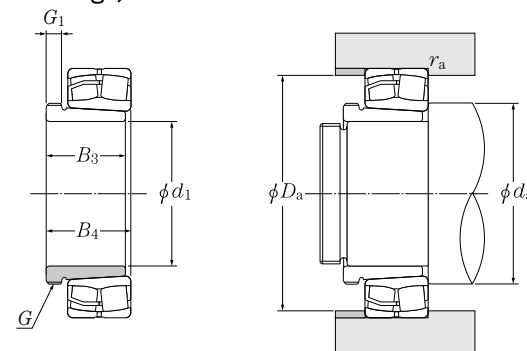

d₁ 35 ~ 70 mm

Boundary dimensions	Numbers ³⁾		Installation-related dimensions			Mass ⁴⁾	Applied nut number	Bearing number ⁵⁾				
	mm		mm						kg			
d ₁	Thread nominal dimension ¹⁾	B ₃	G ₁	B ₄ ²⁾	Bearing	Withdrawal sleeve	d _a	D _a	r _{as}	(approx.)		
35	M45×1.5	29	6	32	* 22208EAKD1 ;AH 308	47	50	71	73	1.1	0.09	AN09
	M45×1.5	29	6	32	21308CK ;AH 308	48.5	52	76	81.5	1.5	0.09	AN09
	M45×1.5	40	7	43	* 22308EAKD1 ;AH 2308	49	52	78	81	1.5	0.128	AN09
40	M50×1.5	31	6	34	* 22209EAKD1 ;AH 309	52	54	76	78	1.1	0.109	AN10
	M50×1.5	31	6	34	21309CK ;AH 309	53.5	57	85	91.5	1.5	0.109	AN10
	M50×1.5	44	7	47	* 22309EAKD1 ;AH 2309	54	58	87	91	1.5	0.164	AN10
45	M55×2	35	7	38	* 22210EAKD1 ;AHX 310	57	59	81	83	1.1	0.137	AN11
	M55×2	35	7	38	21310CK ;AHX 310	60	65	93	100	2	0.137	AN11
	M55×2	50	9	53	* 22310EAKD1 ;AHX 2310	61	63	95	99	2	0.209	AN11
50	M60×2	37	7	40	* 22211EAKD1 ;AHX 311	64	66	90	91	1.5	0.161	AN12
	M60×2	37	7	40	21311K ;AHX 311	65	73	102	110	2	0.161	AN12
	M60×2	54	10	57	* 22311EAKD1 ;AHX 2311	66	68	104	109	2	0.253	AN12
55	M65×2	40	8	43	* 22212EAKD1 ;AHX 312	69	71	99	101	1.5	0.189	AN13
	M65×2	40	8	43	21312K ;AHX 312	72	78	109	118	2.1	0.189	AN13
	M65×2	58	11	61	* 22312EAKD1 ;AHX 2312	72	75	113	118	2.1	0.297	AN13
60	M75×2	42	8	45	* 22213EAKD1 ;AH 313	74	78	107	111	1.5	0.253	AN15
	M75×2	42	8	45	21313K ;AH 313	77	85	119	128	2.1	0.253	AN15
	M75×2	61	12	64	* 22313EAKD1 ;AH 2313	77	81	122	128	2.1	0.395	AN15
65	M80×2	43	8	47	* 22214EAKD1 ;AH 314	79	84	113	116	1.5	0.28	AN16
	M80×2	43	8	47	21314K ;AH 314	82	91	126	138	2.1	0.28	AN16
	M80×2	64	12	68	* 22314EAKD1 ;AHX 2314	82	85	131	138	2.1	0.466	AN16
70	M85×2	45	8	49	* 22215EAKD1 ;AH 315	84	88	118	121	1.5	0.313	AN17
	M85×2	45	8	49	21315K ;AH 315	87	99	136	148	2.1	0.313	AN17
	M85×2	68	12	72	* 22315EAKD1 ;AHX 2315	87	91	139	148	2.1	0.534	AN17

1) Standard thread shapes and dimensions are as per JIS B 0205-1 and JIS B 0205-4 (general metric thread).

2) Indicates reference dimensions before withdrawal sleeves are attached.

3) Bearing numbers marked "*" designate ULTAGE Series.

4) Indicates withdrawal sleeve mass.

5) Indicates the number of nuts to be used at the time of disassembly. Refer to pages D-2 to D-10 for nut dimensions.

Note: Refer to pages B-218 to B-221 for bearing dimensions, rated loads, and mass.

Withdrawal Sleeves



(For spherical roller bearings)

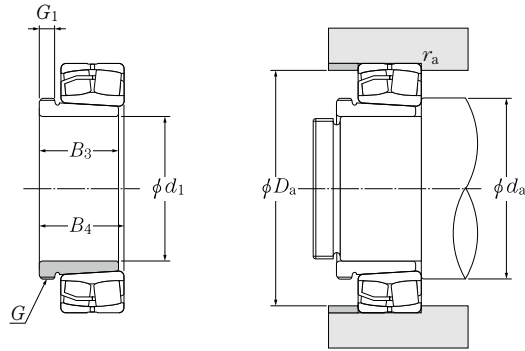

d₁ 75 ~ 115mm

d ₁	Boundary dimensions mm				Numbers ³⁾	Installation-related dimensions mm					Mass ⁴⁾ kg	Applied nut number Bearing number ⁵⁾	
	Thread nominal dimension ¹⁾ G	B ₃	G ₁	B ₄ ²⁾		Bearing	Withdrawal sleeve	d _a	D _a	r _{as}			
75	M90×2	48	8	52	* 22216EAKD1	;AH 316	91	94	127	129	2	0.365	AN18
	M90×2	48	8	52	21316K	;AH 316	92	105	144	158	2	0.365	AN18
	M90×2	71	12	75	* 22316EAKD1	;AHX 2316	92	98	148	158	2.1	0.597	AN18
80	M95×2	52	9	56	* 22217EAKD1	;AHX 317	96	100	137	139	2	0.429	AN19
	M95×2	52	9	56	21317K	;AHX 317	99	111	152	166	2.5	0.429	AN19
	M95×2	74	13	78	* 22317EAKD1	;AHX 2317	99	107	157	166	3.0	0.67	AN19
85	M100×2	53	9	57	* 22218EAKD1	;AHX 318	101	105	144	149	2	0.461	AN20
	M100×2	63	10	67	* 23218EMKD1	;AHX 3218	101	104	141	149	2	0.576	AN20
	M100×2	53	9	57	21318K	;AHX 318	104	119	162	176	2.5	0.461	AN20
	M100×2	79	14	83	* 22318EAKD1	;AHX 2318	104	110	166	176	3	0.779	AN20
90	M105×2	57	10	61	* 22219EAKD1	;AHX 319	107	110	153	158	2.1	0.532	AN21
	M105×2	57	10	61	21319K	;AHX 319	109	127	171	186	2.5	0.532	AN21
	M105×2	85	16	89	* 22319EAKD1	;AHX 2319	109	120	174	186	3	0.886	AN21
95	M110×2	59	10	63	* 22220EAKD1	;AHX 320	112	118	161	168	2.1	0.582	AN22
	M110×2	73	11	77	* 23220EMKD1	;AHX 3220	112	118	159	168	2.1	0.767	AN22
	M110×2	59	10	63	21320K	;AHX 320	114	133	179	201	2.5	0.582	AN22
	M110×2	90	16	94	* 22320EAKD1	;AHX 2320	114	127	187	201	3	0.998	AN22
105	M120×2	68	11	72	* 23122EAKD1	;AHX 3122	121	125	161	169	2	0.76	AN24
	M115×2	82	13	91	* 24122EMK30D1	;AH 24122	121	121	158	169	2	0.73	AN23
	M120×2	68	11	72	* 22222EAKD1	;AHX 3122	122	130	179	188	2.1	0.76	AN24
	M125×2	82	11	86	* 23222EMKD1	;AHX 3222	122	130	176	188	2.1	1.04	AN25
	M120×2	63	12	67	21322K	;AHX 322	124	146	203	226	2.5	0.663	AN24
	M125×2	98	16	102	* 22322EAKD1	;AHX 2322	124	139	209	226	3	1.35	AN25
115	M130×2	60	13	64	* 23024EAKD1	;AHX 3024	129	134	165	171	2	0.75	AN26
	M125×2	73	13	82	* 24024EMK30D1	;AH 24024	129	132	161	171	2	0.65	AN25
	M130×2	75	12	79	* 23124EAKD1	;AHX 3124	131	138	179	189	2	0.95	AN26
	M130×2	93	13	102	* 24124EMK30D1	;AH 24124	131	136	173	189	2	1	AN26

1) Standard thread shapes and dimensions are as per JIS B 0205-1 and JIS B 0205-4 (general metric thread).
 2) Indicates reference dimensions before withdrawal sleeves are attached.
 3) Bearing numbers marked "*" designate ULTAGE Series.
 4) Indicates withdrawal sleeve mass.
 5) Indicates the number of nuts to be used at the time of disassembly. Refer to pages D-2 to D-10 for nut dimensions.
 Note: Refer to pages B-220 to B-223 for bearing dimensions, rated loads, and mass.

Withdrawal Sleeves



(For spherical roller bearings)

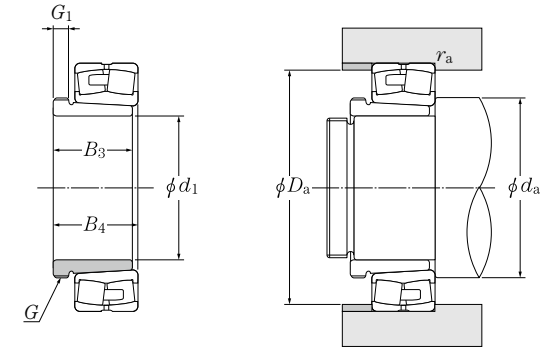

d₁ 115 ~ 150mm

d ₁	Boundary dimensions mm				Numbers ³⁾	Installation-related dimensions mm					Mass ⁴⁾ kg	Applied nut number Bearing number ⁵⁾	
	Thread nominal dimension ¹⁾ G	B ₃	G ₁	B ₄ ²⁾		Bearing	Withdrawal sleeve	d _a	D _a	r _{as}			
115	M130×2	75	12	79	* 22224EAKD1	;AHX 3124	132	141	193	203	2.1	0.95	AN26
	M135×2	90	13	94	* 23224EMKD1	;AHX 3224	132	139	190	203	2.1	1.3	AN27
	M135×2	105	17	109	* 22324EAKD1	;AHX 2324	134	156	225	246	3	1.6	AN27
125	M140×2	67	14	71	* 23026EAKD1	;AHX 3026	139	145	183	191	2	0.93	AN28
	M135×2	83	14	93	* 24026EMK30D1	;AH 24026	139	143	178	191	2	0.84	AN27
	M140×2	78	12	82	* 23126EAKD1	;AHX 3126	141	148	189	199	2	1.08	AN28
	M140×2	94	14	104	* 24126EMK30D1	;AH 24126	141	146	183	199	2	1.11	AN28
135	M140×2	78	12	82	* 22226EAKD1	;AHX 3126	144	151	206	216	3	1.08	AN28
	M145×2	98	15	102	* 23226EMKD1	;AHX 3226	144	150	203	216	3	1.58	AN29
	M145×2	115	19	119	* 22326EAKD1	;AHX 2326	147	164	243	263	4	1.97	AN29
	150	M150×2	68	14	73	* 23028EAKD1	;AHX 3028	149	155	193	201	2	1.01
M145×2		83	14	93	* 24028EMK30D1	;AH 24028	149	153	188	201	2	0.91	AN29
M150×2		83	14	88	* 23128EAKD1	;AHX 3128	152	159	203	213	2.1	1.28	AN30
M150×2		99	14	109	* 24128EMK30D1	;AH 24128	152	156	198	213	2.1	1.25	AN30
M150×2		83	14	88	* 22228EAKD1	;AHX 3128	154	163	224	236	3	1.28	AN30
M155×3		104	15	109	* 23228EMKD1	;AHX 3228	154	162	220	236	3	1.84	AN31
145	M155×3	125	20	130	* 22328EAKD1	;AHX 2328	157	181	261	283	4	2.33	AN31
	M160×3	72	15	77	* 23030EAKD1	;AHX 3030	161	167	207	214	2.1	1.15	AN32
	M155×3	90	15	101	* 24030EMK30D1	;AH 24030	161	165	202	214	2.1	1.04	AN31
	M165×3	96	15	101	* 23130EAKD1	;AHX 3130	162	171	223	238	2.1	1.79	AN33
	M160×3	115	15	126	* 24130EMK30D1	;AH 24130	162	168	216	238	2.1	1.56	AN32
	M165×3	96	15	101	* 22230EAKD1	;AHX 3130	164	177	242	256	3	1.79	AN33
150	M165×3	114	17	119	* 23230EMKD1	;AHX 3230	164	174	237	256	3	2.22	AN33
	M165×3	135	24	140	* 22330EMKD1	;AHX 2330	167	188	279	303	4	2.82	AN33
	M170×3	77	16	82	* 23032EAKD1	;AH 3032	171	177	221	229	2.1	2.06	AN34
	M170×3	95	15	106	* 24032EMK30D1	;AH 24032	171	175	215	229	2.1	2.33	AN34
150	M180×3	103	16	108	* 23132EAKD1	;AH 3132	172	185	240	258	2.1	3.21	AN36
	M170×3	124	15	135	* 24132EMK30D1	;AH 24132	172	181	232	258	2.1	3	AN34
	M180×3	103	16	108	* 22232EAKD1	;AH 3132	174	190	260	276	3	3.21	AN36

1) Standard thread shapes and dimensions are as per JIS B 0205-1 and JIS B 0205-4 (metric trapezoidal screw thread).
 2) Indicates reference dimensions before withdrawal sleeves are attached.
 3) Bearing numbers marked "*" designate ULTAGE Series.
 4) Indicates withdrawal sleeve mass.
 5) Indicates the number of nuts to be used at the time of disassembly. Refer to pages D-2 to D-10 for nut dimensions.
 Note: Refer to pages B-222 to B-227 for bearing dimensions, rated loads, and mass.

Withdrawal Sleeves



(For spherical roller bearings)

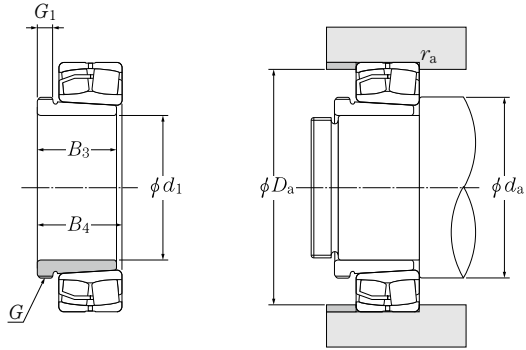

d₁ 150 ~ 190mm

d ₁	Boundary dimensions mm				Numbers ³⁾	Installation-related dimensions					Mass ⁴⁾ kg	Applied nut number Bearing number ⁵⁾	
	Thread nominal dimension ¹⁾ G	B ₃	G ₁	B ₄ ²⁾		Bearing	Withdrawal sleeve	d _a mm		r _{as} mm			
150	M180x3	124	20	130	* 23232EMKD1	;AH 3232	174	187	254	276	3	4.08	AN36
	M180x3	140	24	146	* 22332EMKD1	;AH 2332	177	205	296	323	4	4.72	AN36
160	M180x3	85	17	90	* 23034EAKD1	;AH 3034	181	190	238	249	2.1	2.43	AN36
	M180x3	106	16	117	* 24034EMK30D1	;AH 24034	181	186	231	249	2.1	2.8	AN36
	M190x3	104	16	109	* 23134EAKD1	;AH 3134	182	195	250	268	2.1	3.4	AN38
	M180x3	125	16	136	* 24134EMK30D1	;AH 24134	182	193	243	268	2.1	3.21	AN36
	M190x3	104	16	109	* 22234EMKD1	;AH 3134	187	201	277	293	4	3.4	AN38
	M190x3	134	24	140	* 23234EMKD1	;AH 3234	187	199	272	293	4	4.8	AN38
170	M190x3	146	24	152	* 22334EMKD1	;AH 2334	187	223	313	343	4	5.25	AN38
	M190x3	92	17	98	* 23036EAKD1	;AH 3036	191	201	255	269	2.1	2.81	AN38
	M190x3	116	16	127	* 24036EMK30D1	;AH 24036	191	199	248	269	2.1	3.1	AN38
	M200x3	116	19	122	* 23136EAKD1	;AH 3136	194	205	267	286	3	4.22	AN40
	M190x3	134	16	145	* 24136EMK30D1	;AH 24136	194	202	254	286	3	3.68	AN38
	M200x3	105	17	110	* 22236EMKD1	;AH 2236	197	209	287	303	4	3.73	AN40
180	M200x3	140	24	146	* 23236EMKD1	;AH 3236	197	210	282	303	4	5.32	AN40
	M200x3	154	26	160	* 22336EMKD1	;AH 2336	197	229	324	363	4	5.83	AN40
	Tr205x4	96	18	102	* 23038EAKD1	;AH 3038	201	213	266	279	2.1	3.32	HNL41
	M200x3	118	18	131	* 24038EMK30D1	;AH 24038	201	209	258	279	2.1	3.5	AN40
	Tr210x4	125	20	131	* 23138EMKD1	;AH 3138	204	221	284	306	3	4.89	HN42
	M200x3	146	18	159	* 24138EMK30D1	;AH 24138	204	216	275	306	3	4.28	AN40
190	Tr210x4	112	18	117	* 22238EMKD1	;AH 2238	207	222	305	323	4	4.25	HN42
	Tr210x4	145	25	152	* 23238EMKD1	;AH 3238	207	220	299	323	4	5.9	HN42
	Tr210x4	160	26	167	* 22338EMKD1	;AH 2338	210	247	346	380	5	6.63	HN42
	Tr215x4	102	19	108	* 23040EMKD1	;AH 3040	211	223	283	299	2.1	3.8	HNL43
190	Tr210x4	127	18	140	* 24040EMK30D1	;AH 24040	211	221	275	299	2.1	3.93	HN42
	Tr220x4	134	21	140	* 23140EMKD1	;AH 3140	214	231	301	326	3	5.49	HN44
	Tr210x4	158	18	171	* 24140EMK30D1	;AH 24140	214	224	291	326	3	5.1	HN42

1) Standard thread shapes and dimensions are as per JIS B 0205-1 and JIS B 0205-4 (general metric thread), and JIS B 0206 (metric trapezoidal screw thread).
 2) Indicates reference dimensions before withdrawal sleeves are attached.
 3) Bearing numbers marked "*" designate ULTAGE Series.
 4) Indicates withdrawal sleeve mass.
 5) Indicates the number of nuts to be used at the time of disassembly. Refer to pages D-2 to D-10 for nut dimensions.
 Note: Refer to pages B-226 to B-229 for bearing dimensions, rated loads, and mass.

Withdrawal Sleeves



(For spherical roller bearings)

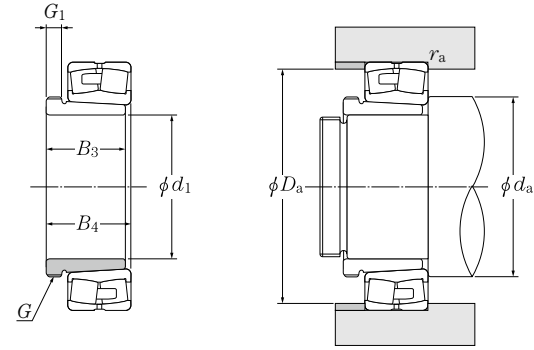

d₁ 190 ~ 260mm

d ₁	Boundary dimensions mm				Numbers ^{3) 4)}	Installation-related dimensions					Mass ⁵⁾ kg	Applied nut number Bearing number ⁶⁾	
	Thread nominal dimension ¹⁾ G	B ₃	G ₁	B ₄ ²⁾		Bearing	Withdrawal sleeve	d _a mm		r _{as} mm			
190	Tr220x4	118	19	123	* 22240EMKD1	;AH 2240	217	234	323	343	4	4.68	HN44
	Tr220x4	153	25	160	* 23240EMKD1	;AH 3240	217	232	315	343	4	6.68	HN44
	Tr220x4	170	30	177	* 22340EMKD1	;AH 2340	220	265	364	400	5	7.54	HN44
200	Tr235x4	111	20	117	* 23044EMKD1	;AH 3044	233	246	310	327	3	7.4	HNL47
	Tr230x4	138	20	152	* 24044EMK30D1	;AH 24044H	233	243	302	327	3	8.25	HN46
	Tr240x4	145	23	151	* 23144EMKD1	;AH 3144	237	252	328	353	4	10.4	HN48
	Tr230x4	170	20	184	* 24144EMK30D1	;AH 24144H	237	247	317	353	4	10.2	HN46
220	Tr240x4	130	20	136	* 22244EMKD1	;AH 2244	237	264	358	383	4	9.1	HN48
	Tr240x4	181	30	189	* 23244EMKD1	;AH 2344	237	261	349	383	4	13.5	HN48
	Tr240x4	181	30	189	* 22344EMKD1	;AH 2344	240	277	388	440	5	13.5	HN48
	Tr260x4	116	21	123	* 23048EMKD1	;AH 3048	253	267	329	347	3	8.75	HNL52
240	Tr250x4	138	20	153	* 24048EMK30D1	;AH 24048H	253	264	322	347	3	8.98	HN50
	Tr260x4	154	25	161	* 23148EMKD1	;AH 3148	257	276	356	383	4	12	HN52
	Tr260x4	180	20	195	* 24148EMK30D1	;AH 24148H	257	270	344	383	4	12.5	HN52
	Tr260x4	144	21	150	* 22248EMKD1	;AH 2248	257	288	383	423	4	11.1	HN52
	Tr260x4	189	30	197	* 23248EMKD1	;AH 2348	257	284	372	423	4	15.5	HN52
	Tr260x4	189	30	197	* 22348EMKD1	;AH 2348	260	299	421	480	5	15.5	HN52
240	Tr280x4	128	23	135	* 23052EMKD1	;AH 3052	275	291	366	385	4	10.7	HNL56
	Tr270x4	162	22	178	* 24052EMK30D1	;AH 24052	275	286	354	385	4	11.8	HN54
	Tr290x4	172	26	179	* 23152EMKD1	;AH 3152	277	302	380	423	4	16.2	HN58
	Tr280x4	202	22	218	* 24152EMK30D1	;AH 24152H	277	295	371	423	4	15.4	HN56
	Tr290x4	155	23	161	* 22252EMKD1	;AH 2252	280	312	415	460	5	14	HN58
	Tr290x4	205	30	213	* 23252EMKD1	;AH 2352	280	310	405	460	5	19.6	HN58
260	Tr290x4	205	30	213	* 22352EMKD1	;AH 2352	286	324	458	514	6	19.6	HN58
	Tr300x4	131	24	139	* 23056EMKD1	;AH 3056	295	310	386	405	4	12	HNL60
	Tr290x4	162	22	179	* 24056EMK30D1	;AH 24056H	295	306	376	405	4	12.8	HN58
Tr310x5	175	28	183	* 23156EMKD1	;AH 3156	300	322	403	440	5	17.5	HN62	

1) Standard thread shapes and dimensions are as per JIS B 0206 (metric trapezoidal screw thread).
 2) Indicates reference dimensions before withdrawal sleeves are attached.
 3) Bearing numbers marked "*" designate ULTAGE Series.
 4) Withdrawal sleeve numbers appended with the suffix "H" signify the high pressure oil (hydraulic) design.
 5) Indicates withdrawal sleeve mass.
 6) Indicates the number of nuts to be used at the time of disassembly. Refer to pages D-2 to D-10 for nut dimensions.
 Note: Refer to pages B-228 to B-231 for bearing dimensions, rated loads, and mass.

Withdrawal Sleeves



(For spherical roller bearings)

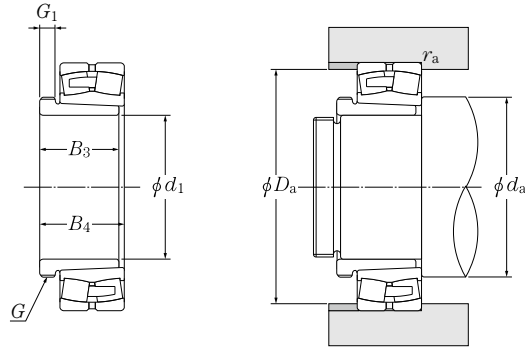

d₁ 260 ~ 360mm

d ₁	Boundary dimensions mm				Numbers ³⁾⁴⁾		Installation-related dimensions mm					Mass ⁵⁾ kg	Applied nut number Bearing number ⁶⁾
	Thread nominal dimension ¹⁾ G	B ₃	G ₁	B ₄ ²⁾	Bearing	Withdrawal sleeve	d _a	D _a	r _{as}	Max. (approx.)			
260	Tr300x4	202	22	219	* 24156EMK30D1 ;AH	24156H	300	316	394	440	5	16.3	HN60
	Tr310x5	155	24	163	* 22256EMK30D1 ;AH	2256H	300	333	437	480	5	15.2	HN62
	Tr310x5	212	30	220	* 23256EMK30D1 ;AH	2356H	300	331	426	480	5	21.6	HN62
	Tr310x5	212	30	220	* 22356EMK30D1 ;AH	2356H	306	349	489	554	6	21.6	HN62
280	Tr320x5	145	26	153	* 23060EMK30D1 ;AH	3060H	315	338	413	445	4	14.4	HNL64
	Tr310x5	184	24	202	* 24060EMK30D1 ;AH	24060H	315	332	401	445	4	15.5	HN62
	Tr330x5	192	30	200	* 23160EMK30D1 ;AH	3160H	320	345	436	480	5	20.8	HN66
	Tr320x5	224	24	242	* 24160EMK30D1 ;AH	24160H	320	340	425	480	5	19.5	HN64
	Tr330x5	170	26	178	* 22260EMK30D1 ;AH	2260H	320	358	469	520	5	18.1	HN66
	Tr330x5	228	34	236	* 23260EMK30D1 ;AH	3260H	320	352	461	520	5	26	HN66
300	Tr345x5	149	27	157	* 23064EMK30D1 ;AH	3064H	335	360	433	465	4	16	HNL69
	Tr340x5	184	24	202	* 24064EMK30D1 ;AH	24064H	335	352	423	465	4	16.6	HN68
	Tr350x5	209	31	217	* 23164EMK30D1 ;AH	3164H	340	373	468	520	5	24.5	HN70
	Tr340x5	242	24	260	* 24164EMK30D1 ;AH	24164H	340	363	457	520	5	21.4	HN68
	Tr350x5	180	27	190	* 22264EMK30D1 ;AH	2264H	340	383	510	560	5	20.2	HN70
	Tr350x5	246	36	254	* 23264EMK30D1 ;AH	3264H	340	376	493	560	5	30.6	HN70
320	Tr365x5	162	28	171	* 23068EMK30D1 ;AH	3068H	358	384	466	502	5	19.5	HNL73
	Tr360x5	206	26	225	* 24068EMK30D1 ;AH	24068H	358	377	456	502	5	21.7	HNL72
	Tr370x5	225	33	234	* 23168EMK30D1 ;AH	3168H	360	393	500	560	5	29	HN74
	Tr360x5	269	26	288	* 24168EMK30D1 ;AH	24168H	360	385	486	560	5	27.1	HNL72
340	Tr385x5	167	30	176	* 23072EMK30D1 ;AH	3072H	378	405	488	522	5	21	HNL77
	Tr380x5	206	26	226	* 24072EMK30D1 ;AH	24072H	378	398	478	522	5	22.7	HNL76
	Tr400x5	229	35	238	23172BK ;AH	3172H	382	417	520	578	5	33	HN80
	Tr380x5	269	26	289	24172BK30 ;AH	24172H	382	414	507	578	5	29.6	HNL76
360	Tr410x5	170	31	180	* 23076EMK30D1 ;AH	3076H	398	425	509	542	5	23.2	HNL82
	Tr400x5	208	28	228	* 24076EMK30D1 ;AH	24076H	398	420	499	542	5	23.7	HNL80
	Tr420x5	232	36	242	23176BK ;AH	3176H	402	436	540	598	5	35.7	HN84
	Tr400x5	271	28	291	24176BK30 ;AH	24176H	402	431	529	598	5	31.3	HNL80

1) Standard thread shapes and dimensions are as per JIS B 0216 (metric trapezoidal screw thread).
 2) Indicates reference dimensions before withdrawal sleeves are attached.
 3) Bearing numbers marked "*" designate ULTAGE Series.
 4) Withdrawal sleeve numbers appended with the suffix "H" signify the high pressure oil (hydraulic) design.
 5) Indicates withdrawal sleeve mass.
 6) Indicates the number of nuts to be used at the time of disassembly. Refer to pages D-2 to D-10 for nut dimensions.
 Note: Refer to pages B-230 to B-233 for bearing dimensions, rated loads, and mass.

Withdrawal Sleeves



(For spherical roller bearings)

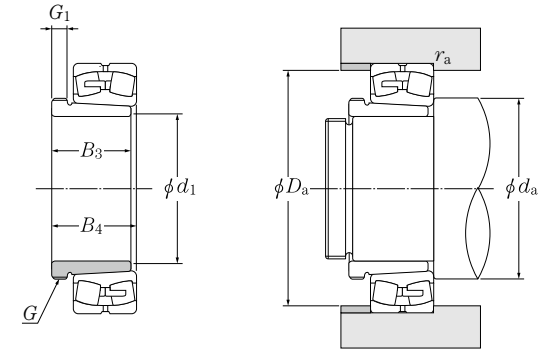

d₁ 380 ~ 460mm

d ₁	Boundary dimensions mm				Numbers ³⁾		Installation-related dimensions mm					Mass ⁴⁾ kg	Applied nut number Bearing number ⁵⁾
	Thread nominal dimension ¹⁾ G	B ₃	G ₁	B ₄ ²⁾	Bearing	Withdrawal sleeve	d _a	D _a	r _{as}	Max. (approx.)			
380	Tr430x5	183	33	193	23080BK ;AH	3080H	422	451	542	578	5	27.3	HNL86
	Tr420x5	228	28	248	24080BK30 ;AH	24080H	422	446	528	578	5	27.1	HNL84
	Tr440x5	240	38	250	23180BK ;AH	3180H	428	458	568	622	6	39.5	HN88
	Tr420x5	278	28	298	24180BK30 ;AH	24180H	428	452	552	622	6	34.4	HNL84
400	Tr450x5	186	34	196	23084BK ;AH	3084H	442	471	562	598	5	29	HNL90
	Tr440x5	230	30	252	24084BK30 ;AH	24084H	442	465	551	598	5	29	HNL88
	Tr460x5	266	40	276	23184BK ;AH	3184H	448	488	611	672	6	46.5	HN92
	Tr440x5	310	30	332	24184BK30 ;AH	24184H	448	477	592	672	6	40.3	HNL88
420	Tr470x5	194	35	205	23088BK ;AHX	3088H	468	490	585	622	6	32	HNL94
	Tr460x5	242	30	264	24088BK30 ;AH	24088H	468	485	576	622	6	31.9	HNL92
	Tr480x5	270	42	281	23188BK ;AHX	3188H	468	504	627	692	6	49.8	HN96
440	Tr460x5	310	30	332	24188BK30 ;AH	24188H	468	498	614	692	6	42.3	HN92
	Tr490x5	202	37	213	23092BK ;AHX	3092H	488	512	613	652	6	35.2	HNL98
460	Tr510x6	285	43	296	23192BK ;AHX	3192H	496	534	660	724	7.5	57.9	HN102
	Tr480x5	332	32	355	24192BK30 ;AHX	24192H	496	523	645	724	7.5	47.4	HN96
460	Tr520x6	205	38	217	23096BK ;AHX	3096H	508	532	633	672	6	39.2	HNL104
	Tr530x6	295	45	307	23196BK ;AHX	3196H	516	554	687	754	7.5	63.1	HN106

1) Standard thread shapes and dimensions are as per JIS B 0216 (metric trapezoidal screw thread).
 2) Indicates reference dimensions before withdrawal sleeves are attached.
 3) Withdrawal sleeve numbers appended with the suffix "H" signify the high pressure oil (hydraulic) design.
 4) Indicates withdrawal sleeve mass.
 5) Indicates the number of nuts to be used at the time of disassembly. Refer to pages D-2 to D-10 for nut dimensions.
 Note: Refer to pages B-232 to B-235 for bearing dimensions, rated loads, and mass.

Thrust Bearings



Single direction thrust ball bearings

Thrust spherical roller bearings

Thrust bearings are designed primarily to support axial loads at contact angles between 30° and 90°. Similar to radial bearings, thrust bearing designs may incorporate balls or rollers as rolling elements.

The configuration and characteristics of each type of bearing are given below.

With thrust bearings, it is necessary to supply an axial preload in order to prevent slipping between the bearing's rolling elements and raceways.

For more detailed information, please refer to section "8.3 Bearing preload."

1. Single direction thrust ball bearings

As shown in Fig. 1, the steel balls of single direction thrust ball bearings are arranged between a pair of washers (shaft washer and housing washer), and the normal contact angle is 90°. Axial loads can be supported in only one direction, and radial loads cannot be accommodated. These bearings are not suitable for high speed operation.

Table 1 lists the standard cage types for single direction thrust ball bearings.

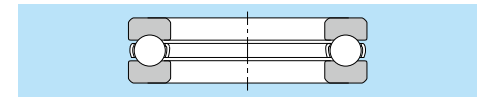





Fig. 1 Single direction thrust ball bearing (example of pressed cage)

Table 1 Standard cage types for single direction thrust ball bearings

Cage type	Resin cage	Pressed cage	Machined cage
Bearing series			
511	51100 ~51107	51108 ~51152	51156 ~511/530
512	51200 ~51207	51208 ~51224	51226 ~51260
513	—	51305 ~51320	51322 ~51340
514	—	51405 ~51415	51416 ~51420

Note: Due to their material properties, resin cages can not be used in applications where temperatures exceed 120°C.



2. Thrust spherical roller bearings

Just like spherical roller bearings, the center of the spherical surface for thrust spherical roller bearings is the point where the raceway surface of the housing raceway washer meets the center axis of the bearing. Since thrust spherical roller bearings incorporate barrel-shaped rollers as rolling elements, they also have self-aligning properties. (See Fig. 2) Under normal load conditions, the allowable misalignment is 1/60 to 1/30, although this will vary depending upon the bearing's dimension series.

These bearings use machined copper alloy cages and a guide sleeve for the cage is attached to the inner ring. These bearings have a high axial load capacity, and can accommodate some radial load when the ring is axially loaded. It is necessary to operate these bearings where the load condition meets $F_r / F_a \leq 0.55$.

The design for spherical thrust bearings is such that lubricant cannot enter the gap between the cage and the guide sleeve.

Therefore, oil lubrication should be used, even in low speed operation.

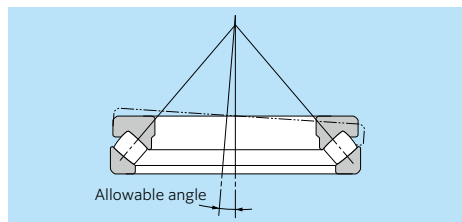

Fig. 2 Thrust spherical roller bearings

3. Thrust cylindrical roller bearings

Thrust bearings incorporating cylindrical rollers are available in single row, double row, triple row, and four row varieties. (See Fig. 3) NTN Engineering offers the 811, 812 and 893 series that conform to dimension series 11, 12 and 93 prescribed in JIS, as well as other special dimensions.

While thrust cylindrical roller bearings are only able to receive axial loads, the axial loads can be heavy due to the high axial rigidity of the bearing. For series 811, 812, and 893, the dimension tables are listed section "E. Needle roller bearings." Bearings with dimensions not listed in the dimension tables are also manufactured. Contact NTN Engineering for more information.

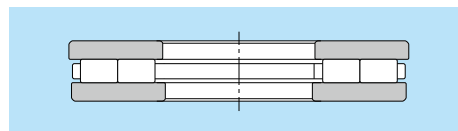

Fig. 3 Double row thrust cylindrical roller bearings

4. Thrust tapered roller bearings

Although not listed in the dimension tables, tapered roller bearings like those in Fig. 4 are also manufactured. Contact NTN Engineering for more detailed information.

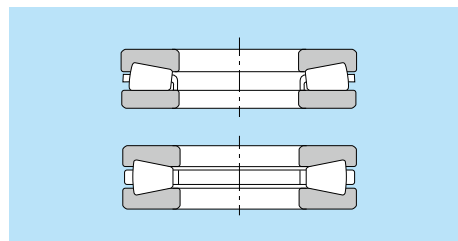
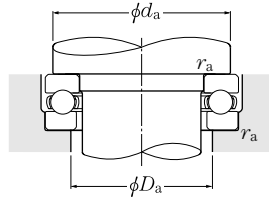
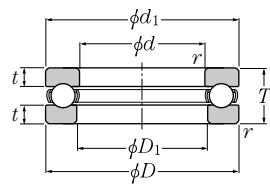

Fig. 4 Thrust tapered roller bearings

Thrust Ball Bearings



Dynamic equivalent axial load
 $P_a = F_a$
 Static equivalent axial load
 $P_{0a} = F_a$

d 10 ~ 50mm

d	Boundary dimensions mm			Basic load rating		Fatigue load limit kN C_u	Allowable speed		Bearing numbers	Dimensions			Installation-related dimensions			Mass kg (approx.)	
	D	T	$r_{s \min}^1$	dynamic kN C_a	static kN C_{0a}		Grease lubrication	Oil lubrication		mm	mm	mm	mm	mm	mm		mm
10	24	9	0.3	10.0	14.0	0.630	6 700	9 500	51100	24	11	2.5	18	16	0.3	0.021	
	26	11	0.6	12.7	17.1	0.770	5 800	8 300		51200	26	12	3.3	20	16	0.6	0.03
12	26	9	0.3	10.3	15.4	0.695	6 400	9 200	51101	26	13	2.5	20	18	0.3	0.023	
	28	11	0.6	13.2	19.0	0.860	5 600	8 000		51201	28	14	3.3	22	18	0.6	0.034
15	28	9	0.3	10.5	16.8	0.755	6 200	8 800	51102	28	16	2.5	23	20	0.3	0.024	
	32	12	0.6	16.6	24.8	1.12	5 000	7 100		51202	32	17	3.5	25	22	0.6	0.046
17	30	9	0.3	10.8	18.2	0.820	6 000	8 500	51103	30	18	2.5	25	22	0.3	0.026	
	35	12	0.6	17.2	27.3	1.23	4 800	6 800		51203	35	19	3.5	28	24	0.6	0.054
20	35	10	0.3	14.2	24.7	1.12	5 200	7 500	51104	35	21	2.5	29	26	0.3	0.04	
	40	14	0.6	22.3	37.5	1.70	4 100	5 900		51204	40	22	4.1	32	28	0.6	0.081
25	42	11	0.6	19.6	37.0	1.68	4 600	6 500	51105	42	26	3	35	32	0.6	0.06	
	47	15	0.6	27.8	50.5	2.28	3 700	5 300		51205	47	27	4.3	38	34	0.6	0.111
	52	18	1	35.5	61.5	2.77	3 200	4 600		51305	52	27	5	41	36	1	0.176
	60	24	1	55.5	89.5	4.05	2 600	3 700		51405	60	27	6.9	46	39	1	0.33
30	47	11	0.6	20.4	42.0	1.90	4 300	6 200	51106	47	32	3	40	37	0.6	0.069	
	52	16	0.6	29.3	58.0	2.63	3 400	4 900		51206	52	32	5	43	39	0.6	0.139
	60	21	1	43.0	78.5	3.55	2 800	3 900		51306	60	32	6.4	48	42	1	0.269
	70	28	1	72.5	126	5.65	2 200	3 200		51406	70	32	8.3	54	46	1	0.516
35	52	12	0.6	20.4	44.5	2.02	3 900	5 600	51107	52	37	3.5	45	42	0.6	0.085	
	62	18	1	39.0	78.0	3.55	2 900	4 200		51207	62	37	5.2	51	46	1	0.215
	68	24	1	55.5	105	4.75	2 400	3 500		51307	68	37	7.2	55	48	1	0.383
	80	32	1.1	87.0	155	7.00	1 900	2 800		51407	80	37	9.6	62	53	1	0.759
40	60	13	0.6	26.9	63.0	2.84	3 500	5 000	51108	60	42	3.8	52	48	0.6	0.125	
	68	19	1	47.0	98.5	4.45	2 700	3 900		51208	68	42	5.5	57	51	1	0.276
	78	26	1	69.0	135	6.05	2 200	3 100		51308	78	42	7.6	63	55	1	0.548
	90	36	1.1	112	205	9.25	1 700	2 500		51408	90	42	10.7	70	60	1	1.08
45	65	14	0.6	27.9	69.0	3.10	3 200	4 600	51109	65	47	4	57	53	0.6	0.148	
	73	20	1	47.5	105	4.75	2 600	3 700		51209	73	47	6	62	56	1	0.317
	85	28	1	80.0	163	7.35	2 000	2 900		51309	85	47	8.3	69	61	1	0.684
	100	39	1.1	130	242	10.9	1 600	2 200		51409	100	47	11.6	78	67	1	1.43
50	70	14	0.6	28.8	75.5	3.40	3 100	4 500	51110	70	52	4	62	58	0.6	0.161	
	78	22	1	48.5	111	5.05	2 400	3 400		51210	78	52	7	67	61	1	0.378

1) Smallest allowable dimension for chamfer dimension r . 2) Maximum allowable dimension for shaft washer outer dimension d_1 .
 3) Smallest allowable dimension for housing washer inner dimension D_1 .

Thrust Ball Bearings

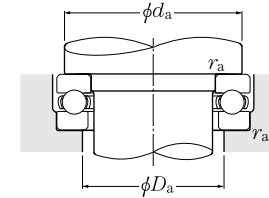
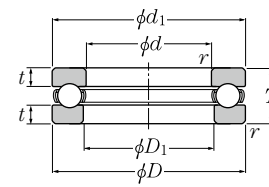

Dynamic equivalent axial load
 $P_a = F_a$
 Static equivalent axial load
 $P_{0a} = F_a$

d 50 ~ 90mm

d	Boundary dimensions mm			Basic load rating		Fatigue load limit kN C_u	Allowable speed		Bearing numbers ⁴⁾	Dimensions			Installation-related dimensions			Mass kg (approx.)	
	D	T	$r_{s \min}^1$	dynamic kN C_a	static kN C_{0a}		Grease lubrication	Oil lubrication		mm	mm	mm	mm	mm	mm		
50	95	31	1.1	96.5	202	9.10	1 800	2 600	51310	95	52	9.2	77	68	1	0.951	
	110	43	1.5	148	283	12.8	1 400	2 000		51410A	110	52	12.9	86	74	1.5	1.9
55	78	16	0.6	35.0	93.0	4.20	2 800	4 000	51111	78	57	5	69	64	0.6	0.226	
	90	25	1	69.5	159	7.15	2 100	3 000		51211	90	57	7.5	76	69	1	0.608
	105	35	1.1	119	246	11.1	1 600	2 300		51311	105	57	10.2	85	75	1	1.29
	120	48	1.5	178	360	16.2	1 300	1 800		51411	120	57	14.8	94	81	1.5	2.52
60	85	17	1	41.5	113	5.10	2 600	3 700	51112	85	62	5	75	70	1	0.296	
	95	26	1	73.5	179	8.05	2 000	2 800		51212	95	62	8	81	74	1	0.676
	110	35	1.1	123	267	12.0	1 600	2 300		51312	110	62	10.2	90	80	1	1.37
	130	51	1.5	214	435	19.7	1 200	1 700		51412	130	62	15.3	102	88	1.5	3.12
65	90	18	1	41.5	117	5.30	2 400	3 500	51113	90	67	5.5	80	75	1	0.338	
	100	27	1	75.0	189	8.50	1 900	2 700		51213	100	67	8.4	86	79	1	0.767
	115	36	1.1	128	287	13.0	1 500	2 200		51313	115	67	10.7	95	85	1	1.51
	140	56	2	232	495	22.0	1 100	1 600		51413	140	68	17.2	110	95	2	3.96
70	95	18	1	43.0	127	5.70	2 400	3 400	51114	95	72	5.5	85	80	1	0.356	
	105	27	1	76.0	199	8.95	1 800	2 600		51214	105	72	8.4	91	84	1	0.793
	125	40	1.1	148	340	15.3	1 400	2 000		51314	125	72	12	103	92	1	2.01
	150	60	2	250	555	23.8	1 000	1 500		51414	150	73	18.6	118	102	2	4.86
75	100	19	1	44.5	136	6.15	2 200	3 200	51115	100	77	6	90	85	1	0.399	
	110	27	1	77.5	209	9.40	1 800	2 600		51215	110	77	8.4	96	89	1	0.874
	135	44	1.5	171	395	17.4	1 300	1 800		51315	135	77	13.4	111	99	1.5	2.61
	160	65	2	269	615	25.6	940	1 400		51415	160	78	20.4	125	110	2	5.97
80	105	19	1	44.5	141	6.35	2 200	3 100	51116	105	82	6	95	90	1	0.422	
	115	28	1	78.5	218	9.85	1 700	2 400		51216	115	82	8.9	101	94	1	0.916
	140	44	1.5	176	425	18.2	1 200	1 800		51316	140	82	13.4	116	104	1.5	2.72
	170	68	2.1	270	620	25.0	890	1 300		51416	170	83	21.3	133	117	2	7.77
85	110	19	1	46.0	150	6.80	2 100	3 000	51117	110	87	6	100	95	1	0.444	
	125	31	1	95.5	264	11.6	1 600	2 200		51217	125	88	9.8	109	101	1	1.25
	150	49	1.5	206	490	20.3	1 100	1 600		51317	150	88	15	124	111	1.5	3.52
	180	72	2.1	288	685	26.8	840	1 200		* 51417	177	88	22.7	141	124	2	9.17
90	120	22	1	59.5	190	8.35	1 900	2 700	51118	120	92	7	108	102	1	0.687	
	135	35	1.1	117	325	13.9	1 400	2 000		51218	135	93	11.2	117	108	1	1.7
	155	50	1.5	213	525	21.3	1 100	1 600		51318	155	93	15.5	129	116	1.5	3.74
	190	77	2.1	305	750	28.6	790	1 100		* 51418	187	93	24.5	149	131	2	11

1) Smallest allowable dimension for chamfer dimension r . 2) Maximum allowable dimension for shaft washer outer dimension d_1 . 3) Smallest allowable dimension for housing washer inner dimension D_1 . 4) Bearing numbers marked "*" signify bearings where the bearing shaft washer outer diameter is smaller than the housing shaft washer outer diameter. Therefore when using these bearings, it is possible to use the housing bore as is, without providing a ground undercut on the outer diameter section of the bearing shaft washer as shown in the drawing.

Thrust Ball Bearings

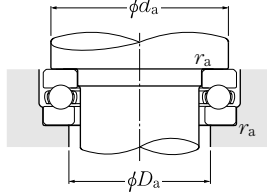
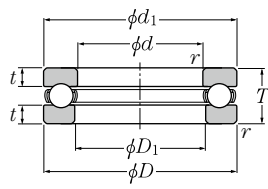

Dynamic equivalent axial load
 $P_a = F_a$
 Static equivalent axial load
 $P_{0a} = F_a$

d 100 ~ 200mm

	Boundary dimensions			Basic load rating		Fatigue load limit	Allowable speed		Bearing numbers ⁴⁾	Dimensions			Installation-related dimensions			Mass
	d	D	T	dynamic	static		Grease lubrication	Oil lubrication		mm	mm	mm	mm	mm	mm	
			$r_{s \min}^{1)}$	C_a	C_{0a}	C_u				$d_{1s \max}^{2)}$	$D_{1s \min}^{3)}$	t	Min.	Max.	Max.	(approx)
100	135	25	1	85.0	268	11.2	1 700	2 400	51120	135	102	7.5	121	114	1	0.987
	150	38	1.1	147	410	16.6	1 300	1 800	51220	150	103	11.7	130	120	1	2.29
	170	55	1.5	237	595	23.1	990	1 400	51320	170	103	17.3	142	128	1.5	4.88
	210	85	3	370	970	35.0	710	1 000	* 51420	205	103	26.6	165	145	2.5	14.7
110	145	25	1	87.0	288	11.5	1 600	2 300	51122	145	112	7.5	131	124	1	1.07
	160	38	1.1	153	450	17.5	1 200	1 800	51222	160	113	11.7	140	130	1	2.46
	190	63	2	267	705	25.9	870	1 200	* 51322	187	113	20	158	142	2	7.67
120	155	25	1	89.0	310	11.8	1 500	2 200	51124	155	122	7.5	141	134	1	1.11
	170	39	1.1	154	470	17.7	1 200	1 700	51224	170	123	12.2	150	140	1	2.71
	210	70	2.1	296	805	28.3	780	1 100	* 51324	205	123	22.3	173	157	2	10.8
130	170	30	1	104	350	13.0	1 300	1 900	51126	170	132	9	154	146	1	1.73
	190	45	1.5	191	565	20.2	1 000	1 500	* 51226	187	133	13.9	166	154	1.5	4.22
	225	75	2.1	330	960	32.5	720	1 000	* 51326	220	134	24.2	186	169	2	12.7
140	180	31	1	107	375	13.4	1 300	1 800	* 51128	178	142	9.5	164	156	1	1.9
	200	46	1.5	193	595	20.6	980	1 400	* 51228	197	143	14.4	176	164	1.5	4.77
	240	80	2.1	350	1 050	34.5	670	960	* 51328	235	144	26	199	181	2	15.3
150	190	31	1	109	400	13.9	1 200	1 800	* 51130	188	152	10	174	166	1	2
	215	50	1.5	227	720	24.0	900	1 300	* 51230	212	153	15.8	189	176	1.5	5.87
	250	80	2.1	360	1 130	36.0	660	940	* 51330	245	154	26	209	191	2	16.1
160	200	31	1	112	425	14.4	1 200	1 700	* 51132	198	162	10	184	176	1	2.1
	225	51	1.5	223	720	23.3	870	1 200	* 51232	222	163	16.3	199	186	1.5	6.32
	270	87	3	450	1 470	45.0	600	860	* 51332	265	164	27	225	205	2.5	20.7
170	215	34	1.1	134	510	16.7	1 100	1 600	* 51134	213	172	10.5	197	188	1	2.77
	240	55	1.5	261	835	26.3	810	1 200	* 51234	237	173	17.3	212	198	1.5	7.81
	280	87	3	465	1 570	47.5	590	840	* 51334	275	174	27	235	215	2.5	21.6
180	225	34	1.1	135	525	16.7	1 100	1 500	* 51136	222	183	10.5	207	198	1	2.92
	250	56	1.5	266	875	26.9	780	1 100	* 51236	247	183	17.8	222	208	1.5	8.34
	300	95	3	490	1 700	49.5	540	780	* 51336	295	184	29.7	251	229	2.5	27.5
190	240	37	1.1	170	655	20.2	980	1 400	* 51138	237	193	11	220	210	1	3.75
	270	62	2	310	1 060	31.5	710	1 000	* 51238	267	194	19.6	238	222	2	11.3
	320	105	4	545	1 950	55.0	500	710	* 51338	315	195	33.5	266	244	3	35

200 250 37 1.1 172 675 20.4 960 1 400 * **51140** 247 203 11.5 230 220 1 3.92
 1) Smallest allowable dimension for chamfer dimension r. 2) Maximum allowable dimension for shaft washer outer dimension d_1 . 3) Smallest allowable dimension for housing washer inner dimension D_1 . 4) Bearing numbers marked "*" signify bearings where the bearing shaft washer outer diameter is smaller than the housing shaft washer outer diameter. Therefore when using these bearings, it is possible to use the housing bore as is, without providing a ground undercut on the outer diameter section of the bearing shaft washer as shown in the drawing.

Thrust Ball Bearings

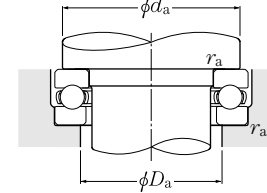
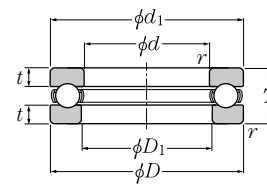

Dynamic equivalent axial load
 $P_a = F_a$
 Static equivalent axial load
 $P_{0a} = F_a$

d 200 ~ 530mm

	Boundary dimensions			Basic load rating		Fatigue load limit	Allowable speed		Bearing numbers ⁴⁾	Dimensions			Installation-related dimensions			Mass
	d	D	T	dynamic	static		Grease lubrication	Oil lubrication		mm	mm	mm	mm	mm	mm	
			$r_{s \min}^{1)}$	C_a	C_{0a}	C_u				$d_{1s \max}^{2)}$	$D_{1s \min}^{3)}$	t	Min.	Max.	Max.	(approx)
200	280	62	2	315	1 110	32.0	700	990	* 51240	277	204	19.6	248	232	2	11.8
	340	110	4	595	2 220	61.0	470	670	* 51340	335	205	34.7	282	258	3	41.8
220	270	37	1.1	177	740	21.3	920	1 300	* 51144	267	223	11.5	250	240	1	4.27
	300	63	2	325	1 210	34.0	660	950	* 51244	297	224	20.1	268	252	2	13
240	300	45	1.5	228	935	25.6	780	1 100	* 51148	297	243	14	276	264	1.5	6.87
	340	78	2.1	415	1 650	44.0	550	790	* 51248	335	244	25	299	281	2	22.4
260	320	45	1.5	232	990	26.2	750	1 100	* 51152	317	263	14	296	284	1.5	7.38
	360	79	2.1	440	1 810	46.5	530	760	* 51252	355	264	24.9	319	301	2	24.2
280	350	53	1.5	305	1 270	32.5	650	940	* 51156	347	283	16	322	308	1.5	11.8
	380	80	2.1	460	1 970	49.0	510	730	* 51256	375	284	25.4	339	321	2	26.1
300	380	62	2	355	1 560	38.0	580	820	* 51160	376	304	19.5	348	332	2	17.2
	420	95	3	590	2 680	63.5	440	630	* 51260	415	304	29.7	371	349	2.5	40.6
320	400	63	2	365	1 660	39.5	550	790	* 51164	396	324	20	368	352	2	18.4
340	420	64	2	375	1 760	40.5	530	760	* 51168	416	344	20.5	388	372	2	19.7
360	440	65	2	380	1 860	42.0	510	730	* 51172	436	364	21	408	392	2	21.1
380	460	65	2	380	1 910	42.0	500	710	* 51176	456	384	21	428	412	2	22.3
400	480	65	2	390	2 010	43.5	480	690	* 51180	476	404	21	448	432	2	23.3
420	500	65	2	395	2 110	44.5	470	670	* 51184	495	424	21	468	452	2	24.4
440	540	80	2.1	515	2 850	58.0	400	580	* 51188	535	444	26	499	481	2	40
460	560	80	2.1	525	3 000	60.0	390	560	* 51192	555	464	26	519	501	2	41.6
480	580	80	2.1	525	3 100	60.5	380	550	* 51196	575	484	29.5	539	521	2	43.3
500	600	80	2.1	575	3 400	65.5	370	540	511/500	595	504	25	559	541	2	45
530	640	85	3	645	4 000	74.5	350	500	511/530	635	534	26	595	575	2.5	55.8

1) Smallest allowable dimension for chamfer dimension r. 2) Maximum allowable dimension for shaft washer outer dimension d_1 . 3) Smallest allowable dimension for housing washer inner dimension D_1 . 4) Bearing numbers marked "*" signify bearings where the bearing shaft washer outer diameter is smaller than the housing shaft washer outer diameter. Therefore when using these bearings, it is possible to use the housing bore as is, without providing a ground undercut on the outer diameter section of the bearing shaft washer as shown in the drawing.

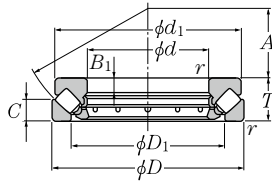

d 60 ~ 160mm

d	Boundary dimensions mm			Basic load rating		Fatigue load limit kN C _u	Allowable speed min ⁻¹ Oil lubrication	Bearing numbers	Dimensions mm				
	D	T	r _{s min} ¹⁾	dynamic kN C _a	static kN C _{0a}				D ₁	d ₁	B ₁	C	A
60	130	42	1.5	315	805	68.5	2 600	29412	89	123	15	20	38
65	140	45	2	370	945	75.5	2 400	29413	96	133	16	21	42
70	150	48	2	405	1 040	87.5	2 200	29414	103	142	17	23	44
75	160	51	2	465	1 190	102	2 100	29415	109	152	18	24	47
80	170	54	2.1	510	1 380	102	1 900	29416	117	162	19	26	50
85	150	39	1.5	295	820	78.5	2 300	29317	114	143.5	13	19	50
	180	58	2.1	545	1 480	118	1 800	29417	125	170	21	28	54
90	155	39	1.5	320	915	84.0	2 300	29318	117	148.5	13	19	52
	190	60	2.1	610	1 680	121	1 700	29418	132	180	22	29	56
100	170	42	1.5	385	1 160	96.0	2 100	29320	129	163	14	20.8	58
	210	67	3	760	2 130	156	1 500	29420	146	200	24	32	62
110	190	48	2	495	1 500	120	1 800	29322	143	182	16	23	64
	230	73	3	940	2 620	193	1 400	29422	162	220	26	35	69
120	210	54	2.1	595	1 770	151	1 600	29324	159	200	18	26	70
	250	78	4	1 080	3 050	212	1 300	29424	174	236	29	37	74
130	225	58	2.1	685	2 100	168	1 500	29326	171	215	19	28	76
	270	85	4	1 200	3 550	232	1 200	29426	189	255	31	41	81
140	240	60	2.1	760	2 360	182	1 400	29328	183	230	20	29	82
	280	85	4	1 240	3 750	252	1 200	29428	199	268	31	41	86
150	215	39	1.5	380	1 340	122	1 800	29230	178	208	14	19	82
	250	60	2.1	750	2 390	191	1 400	29330	194	240	20	29	87
	300	90	4	1 430	4 350	280	1 100	29430	214	285	32	44	92
160	225	39	1.5	400	1 460	126	1 700	29232	188	219	14	19	86
	270	67	3	915	2 860	223	1 300	29332	208	260	24	32	92
	320	95	5	1 670	5 150	320	1 000	29432	229	306	34	45	99

1) Smallest allowable dimension for chamfer dimension r.

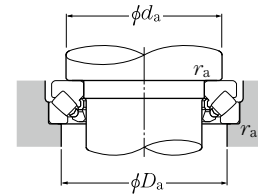

Dynamic equivalent axial load

$$P_a = F_a + 1.2F_r$$

Static equivalent axial load

$$P_{0a} = F_a + 2.7F_r$$

Provided that $\frac{F_r}{F_a} \leq 0.55$ only.

Installation-related dimensions			Mass kg (approx.)
d _a Min.	mm D _a Max.	r _{as} Max.	
90	108	1.5	2.78
100	115	2	3.44
105	125	2	4.19
115	132	2	5.07
120	140	2	6.09
115	135	1.5	2.94
130	150	2	7.2
120	140	1.5	3.08
135	157	2	8.38
130	150	1.5	3.94
150	175	2.5	11.5
145	165	2	5.78
165	190	2.5	15
160	180	2	7.92
180	205	3	18.6
170	195	2	9.76
195	225	3	23.7
185	205	2	11.4
205	235	3	25.2
179	196	1.5	4.56
195	215	2	12
220	250	3	30.5
189	206	1.5	4.88
210	235	2.5	15.9
230	265	4	37

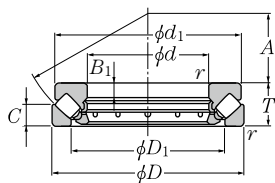

d 170 ~ 320mm

	Boundary dimensions mm				Basic load rating		Fatigue load limit kN <i>C_u</i>	Allowable speed min ⁻¹ Oil lubrication	Bearing numbers	Dimensions mm				
	<i>d</i>	<i>D</i>	<i>T</i>	<i>r_{s min}</i> ¹⁾	dynamic kN <i>C_a</i>	static <i>C_{0a}</i>				<i>D₁</i>	<i>d₁</i>	<i>B₁</i>	<i>C</i>	<i>A</i>
170	240	42	1.5	475	1 770	146	1 600	29234	198	233	15	20	92	
	280	67	3	950	3 050	238	1 200	29334	216	270	23	32	96	
	340	103	5	1840	5 750	345	940	29434	243	324	37	50	104	
180	250	42	1.5	500	1 920	160	1 600	29236	208	243	15	20	97	
	300	73	3	1 110	3 600	272	1 100	29336	232	290	25	35	103	
	360	109	5	2 050	6 200	400	890	29436	255	342	39	52	110	
190	270	48	2	585	2 230	184	1 400	29238	223	262	15	24	104	
	320	78	4	1 280	4 250	294	1 100	29338	246	308	27	38	110	
	380	115	5	2 230	6 800	430	840	29438	271	360	41	55	117	
200	280	48	2	595	2 300	183	1 400	29240	236	271	15	24	108	
	340	85	4	1 420	4 600	330	980	29340	261	325	29	41	116	
	400	122	5	2 490	7 650	465	790	29440	286	380	43	59	122	
220	300	48	2	620	2 480	198	1 300	29244	254	292	15	24	117	
	360	85	4	1 540	5 200	360	940	29344	280	345	29	41	125	
	420	122	6	2 560	8 100	505	760	29444	308	400	43	58	132	
240	340	60	2.1	890	3 600	271	1 100	29248	283	330	19	30	130	
	380	85	4	1 530	5 250	390	910	29348	300	365	29	41	135	
	440	122	6	2 680	8 700	530	740	29448	326	420	43	59	142	
260	360	60	2.1	960	3 950	296	1 100	29252	302	350	19	30	139	
	420	95	5	1 910	6 800	445	810	29352	329	405	32	45	148	
	480	132	6	3 050	10 000	610	670	29452	357	460	48	64	154	
280	380	60	2.1	975	4 050	245	1 000	29256	323	370	19	30	150	
	440	95	5	2 010	7 250	480	790	29356	348	423	32	46	158	
	520	145	6	3 700	12 400	710	610	29456	387	495	52	68	166	
300	420	73	3	1 330	5 350	385	870	29260	353	405	21	38	162	
	480	109	5	2 380	8 250	580	700	29360	379	460	37	50	168	
	540	145	6	3 850	13 200	735	590	29460	402	515	52	70	175	
320	440	73	3	1 400	5 800	415	840	29264	372	430	21	38	172	
	500	109	5	2 470	8 800	605	680	29364	399	482	37	53	180	
	580	155	7.5	4 100	14 200	820	550	29464	435	555	55	75	191	

1) Smallest allowable dimension for chamfer dimension *r*.

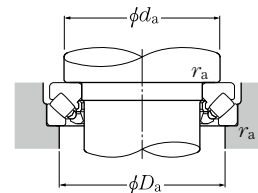

Dynamic equivalent axial load

$$P_a = F_a + 1.2F_r$$

Static equivalent axial load

$$P_{0a} = F_a + 2.7F_r$$

Provided that $\frac{F_r}{F_a} \leq 0.55$ only.

Installation-related dimensions mm			Mass kg (approx.)
<i>d_a</i> Min.	<i>D_a</i> Max.	<i>r_{as}</i> Max.	
201	218	1.5	6.02
220	245	2.5	16.6
245	285	4	45
211	228	1.5	6.27
235	260	2.5	21.2
260	300	4	52.9
225	245	2	8.8
250	275	3	26
275	320	4	62
235	255	2	9.14
265	295	3	31.9
290	335	4	73.3
260	275	2	9.94
285	315	3	34.5
310	355	5	77.8
285	305	2	17.5
300	330	3	36.6
330	375	5	82.6
305	325	2	18.6
330	365	4	52
360	405	5	108
325	345	2	19.8
350	390	4	54.6
390	440	5	140
355	380	2.5	30.9
380	420	4	75.8
410	460	5	147
375	400	2.5	33.5
400	440	4	79.9
435	495	6	181

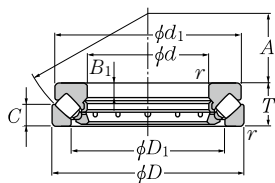

d 340 ~ 500mm

	Boundary dimensions mm				Basic load rating		Fatigue load limit kN C_u	Allowable speed min ⁻¹ Oil lubrication	Bearing numbers	Dimensions mm				
	d	D	T	$r_{s \min}^{1)}$	dynamic kN C_a	static C_{0a}				D_1	d_1	B_1	C	A
340	460	73	3	1 380	5 800	395	820	29268	395	445	21	37	183	
	540	122	5	2 950	10 700	695	610	29368	428	520	41	59	192	
	620	170	7.5	4 900	17 500	925	500	29468	462	590	61	82	201	
360	500	85	4	1 680	7 050	480	720	29272	423	485	25	44	194	
	560	122	5	3 000	11 100	915	590	29372	448	540	41	59	202	
	640	170	7.5	5 000	18 500	950	490	29472	480	610	61	82	210	
380	520	85	4	1 770	7 650	505	700	29276	441	505	27	42	202	
	600	132	6	3 550	13 300	835	550	29376	477	580	44	63	216	
	670	175	7.5	5 450	19 700	1 060	470	29476	504	640	63	85	230	
400	540	85	4	1 800	7 950	525	680	29280	460	526	27	42	212	
	620	132	6	3 750	14 500	865	530	29380	494	596	44	64	225	
	710	185	7.5	6 050	22 100	1 140	440	29480	534	680	67	89	236	
420	580	95	5	2 330	10 400	670	620	29284	489	564	30	46	225	
	650	140	6	4 000	15 500	925	500	29384	520	626	48	68	235	
	730	185	7.5	6 100	22 800	1 190	430	29484	556	700	67	89	244	
440	600	95	5	2 390	10 900	695	600	29288	508	585	30	49	235	
	680	145	6	4 200	16 400	965	480	29388	548	655	49	70	245	
	780	206	9.5	7 100	26 200	1 340	390	29488	588	745	74	100	260	
460	620	95	5	2 390	11 000	900	590	29292	530	605	30	46	245	
	710	150	6	4 700	18 500	1060	460	29392	567	685	51	72	257	
	800	206	9.5	7 350	27 900	1390	380	29492	608	765	74	100	272	
480	650	103	5	2 670	12 000	760	550	29296	556	635	33	55	259	
	730	150	6	4 700	18 700	1 100	450	29396	590	705	51	72	270	
	850	224	9.5	8 350	31 500	1 490	350	29496	638	810	81	108	280	
500	670	103	5	2 830	13 000	810	530	292/500	574	654	33	55	268	
	750	150	6	4 750	19 300	1 140	440	293/500	611	725	51	74	280	
	870	224	9.5	8 450	33 000	1 610	340	294/500	661	830	81	107	290	

1) Smallest allowable dimension for chamfer dimension r.

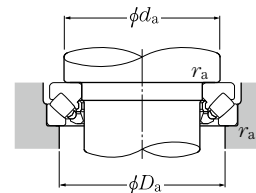

Dynamic equivalent axial load

$$P_a = F_a + 1.2 F_r$$

Static equivalent axial load

$$P_{0a} = F_a + 2.7 F_r$$

Provided that $\frac{F_r}{F_a} \leq 0.55$ only.

Installation-related dimensions mm			Mass kg (approx.)
d_a Min.	D_a Max.	r_{as} Max.	
395	420	2.5	34.4
430	470	4	107
465	530	6	230
420	455	3	50.5
450	495	4	112
485	550	6	240
440	475	3	53.4
480	525	5	143
510	575	6	267
460	490	3	55.8
500	550	5	148
540	610	6	321
490	525	4	76.6
525	575	5	172
560	630	6	333
510	545	4	79.6
550	600	5	195
595	670	8	428
530	570	4	82.8
575	630	5	221
615	690	8	443
555	595	4	98.6
595	650	5	228
645	730	8	552
575	615	4	102
615	670	5	235
670	750	8	569

Special Application Bearings



Special Application Bearings Contents

ULTAGE series Sealed four-row tapered roller bearings for rolling mill roll necks [CROU...LL type]	C- 2
ULTAGE series Sealed spherical roller bearings [WA type]	C- 6
ULTAGE series Spherical roller bearings with high-strength cage [EMA type] ...	C-10
ULTAGE series Deep groove ball bearings for high-speed servo motors [MA type]	C-14
Four-row cylindrical roller bearings	C-18
Four-row tapered roller bearings	C-36
Ultra-thin section type ball bearings	C-58
SL type cylindrical roller bearings	C-66
ULTAGE series Precision rolling bearings for machine tools	C-76
Bearings for special environments	C-76
Rubber molded bearings	C-76
MEGAOHM™ series insulated bearings	C-77
Clutches/torque limiters	C-77



The ULTAGE series sealed four-row tapered roller bearings [CROU...LL type] are designed to provide "high-load capacity," "high static load capacity," and "high sealing performance." These traits are required for steel rolling mill roll neck applications neck applications to improve reliability with a longer operating life.

1. Features

1) High-load capacity design

Higher load capacity and longer operating life are achieved by maximizing the size and number of rollers in the bearing.

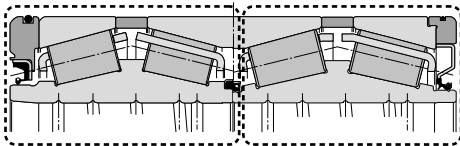

Conventional specification

ULTAGE specification

2) World class static load capacity

Static load capacity is greatly improved due to optimized crowning of the rolling elements, reducing edge stress in the application under heavy loads.

3) Compact seal design with high sealing performance

The ULTAGE series four-row tapered roller bearing utilizes a specially designed fluorine rubber seal for high sealing performance, while minimizing the volume of the seal within the bearing.

Optimizing the tension force of the main seal lip and the overall design of the seal to minimize contamination ingress, reduces the internal water immersion by 50% or more while preventing grease from flowing out from the sub lip.

4) Standard adoption of long-life grease

This bearing is filled with an ample amount of long-life grease to avoid the need for cleaning or filling the bearing with grease before assembling into the application.

2. Part number

(A-) CROU- 6001 LLA1X PX1

- Option (special heat treatment*)
- Bearing type (ULTAGE series four-row tapered roller bearing)
- Bearing bore diameter No. + serial No.
- Seal code
- Tolerance code

* austenite-strengthening treatment

3. Chamfer dimension

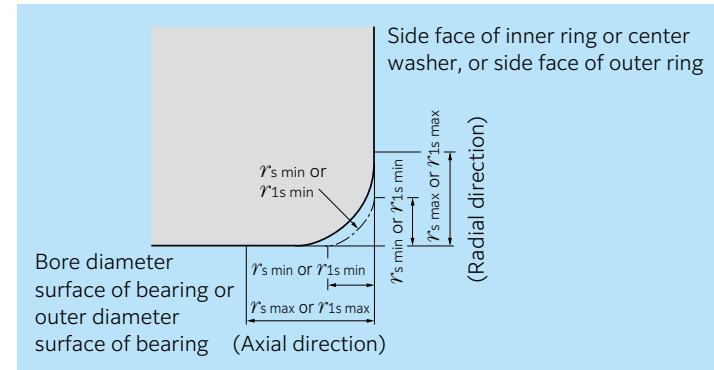

Unit: mm

r's min or r'1s min	Nominal bearing bore diameter		r's max or r'1s max	
	Over d	Incl.	Radial direction	Axial direction
1	50	—	1.9	3
1.5	120 250	250 —	2.8 3.5	3.5 4
2.5	120 250	250 —	4 4.5	5.5 6
3	120 250 400	250 400 —	4.5 5 5.5	6.5 7 7.5

4. Operating temperature range

-20~120°C

5. Bearing fits (recommended)

Metric series : Shaft d6/housing G7

Inch series : Contact **NTN** Engineering.

6. Standard grease fill

Brand : Kyodo Yushi Palmax RBG (L373)

Amount : Space volume ratio 35%

7. Allowable speed

$$d_m \cdot n \leq 30 \times 10^4$$

d_m : Roller pitch diameter (mm) $\div (d+D)/2$

d : Bearing bore diameter (mm)

D : Bearing outside diameter (mm)

n : Rotational speed (min⁻¹)

The above are approximate standard values and may not be appropriate depending on the usage condition. For details, please contact **NTN** Engineering.

8. Material

Inner and outer rings : Case hardened steel

Rolling elements : Bearing steel

(* mark in the dimension table indicates case hardened steel.)

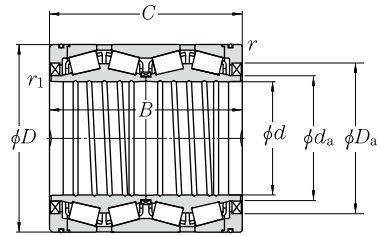

Dynamic equivalent radial load

$$P_r = X F_r + Y F_a$$

$\frac{F_a}{F_r} \leq e$		$\frac{F_a}{F_r} > e$	
X	Y	X	Y
1	Y ₁	0.67	Y ₂

Static equivalent radial load

$$P_{0r} = F_r + Y_0 F_a$$

For values of e , Y_1 , Y_2 and Y_0 see the table below.

Series	Boundary dimensions						(approx.) Standard radial clearance ²⁾	Standard axial clearance ²⁾
	mm							
	d	D	B	C	$r_{1s} \text{ min}^{1)}$	$r_s \text{ min}^{1)}$	mm	mm
Metric series	220	295	315	315	1	2.5	0.093 ~ 0.106	0.420 ~ 0.480
	225	320	230	230	1	2.5	0.099 ~ 0.115	0.360 ~ 0.420
	240	338	248	248	1	2.5	0.104 ~ 0.118	0.450 ~ 0.510
	240	338	340	340	1	2.5	0.107 ~ 0.123	0.400 ~ 0.460
	250	365	270	270	1	2.5	0.113 ~ 0.129	0.420 ~ 0.480
	260	365	340	340	1	2.5	0.115 ~ 0.131	0.430 ~ 0.490
	300	420	310	310	1	2.5	0.131 ~ 0.147	0.490 ~ 0.550
	310	430	350	350	1	2.5	0.136 ~ 0.154	0.520 ~ 0.590
	410	546	400	400	1.5	2.5	0.173 ~ 0.188	0.780 ~ 0.850
	440	590	480	480	1.5	2.5	0.188 ~ 0.204	0.850 ~ 0.920
	440	620	454	454	3	2.5	0.195 ~ 0.211	0.880 ~ 0.950
Inch series	530	780	570	570	3	2.5	0.244 ~ 0.259	1.100 ~ 1.170
	220.662	314.325	239.712	239.712	1	2.5	0.098 ~ 0.111	0.450 ~ 0.510
	254.000	358.775	269.875	269.875	1	2.5	0.111 ~ 0.127	0.430 ~ 0.490
	304.902	412.648	266.700	266.700	1	2.5	0.130 ~ 0.150	0.450 ~ 0.520
	343.052	457.098	254.000	254.000	1	2.5	0.136 ~ 0.158	0.430 ~ 0.500
	343.052	457.098	299.000	299.000	1	2.5	0.143 ~ 0.163	0.500 ~ 0.570
	501.650	711.200	520.700	520.700	3	2.5	0.206 ~ 0.226	0.730 ~ 0.800
	595.312	844.550	615.950	615.950	3	2.5	0.266 ~ 0.282	1.200 ~ 1.270

Basic load rating		Bearing number ³⁾	Installation-related dimensions		Constant e	Axial load factors		
dynamic C_r	static C_{0r}		d_a	D_a		Y_1	Y_2	Y_0
1 890	4 650	CROU-4401LLA1X	235	267	0.33	2.03	3.02	1.98
1 870	3 700	CROU-4501LLA1X	241	294	0.41	1.64	2.44	1.60
2 320	4 600	CROU-4801LLA1X	257	309	0.35	1.95	2.90	1.91
2 970	6 850	CROU-4802LLA1X	257	309	0.40	1.68	2.50	1.64
2 760	5 300	CROU-5001LLA1X	272	333	0.40	1.68	2.50	1.64
3 350	7 450	CROU-5201LLA1X	275	327	0.40	1.68	2.50	1.64
3 600	7 650	CROU-6001LLA1X	318	382	0.40	1.68	2.50	1.64
4 050	8 900	CROU-6201LLA1X	329	388	0.39	1.72	2.56	1.68
5 500	13 300	CROU-8201LLA1X	434	504	0.33	2.03	3.02	1.98
6 600	16 200	CROU-8801LLA1X	462	540	0.33	2.03	3.02	1.98
7 650	16 700	CROU-8802LLA1X	473	570	0.33	2.03	3.02	1.98
13 500	29 400	CROU-10601LLA1X*	581	710	0.33	2.03	3.02	1.98
2 240	4 350	CROU-4402LLA1X	240	290	0.33	2.07	3.09	2.03
2 770	5 700	CROU-5101LLA1X	274	328	0.39	1.74	2.59	1.70
2 810	5 850	CROU-6101LLA1X	323	379	0.43	1.56	2.32	1.52
2 830	5 950	CROU-6901LLA1X	364	423	0.47	1.43	2.12	1.40
3 500	8 150	CROU-6902LLA1X	364	423	0.43	1.57	2.34	1.53
10 100	23 900	CROU-10001LLA1X*	542	642	0.42	1.60	2.38	1.56
14 000	33 000	CROU-11901LLA1X	638	770	0.33	2.03	3.02	1.98

1) Smallest allowable dimension for chamfer dimension r .
2) Consult with **NTN** Engineering because the appropriate value may change depending on the use conditions.

3) Bearing numbers marked "*" use rolling elements made of case hardened steel.

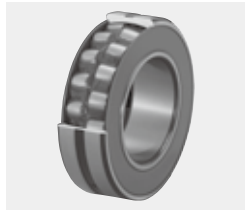

The ULTAGE series sealed spherical roller bearings [WA type] are designed to meet the demands of “long operating life,” “improved reliability,” and “improved easy handling,” which are required for various types of industrial machinery.

1. Features

1) World class load capacity

Higher load capacity and longer operating life have been realized by adopting the internal specifications of the EA type, which includes maximum possible roller diameter size, maximum possible number of rollers, and a “basket-shaped” pressed steel cage.

2) Compact design with minimized seal volume

The standard seal design is a “contact type” dust resistant seal designed to minimize the volume of the seal within the bearing.

- (1) Foreign matter intrusion is prevented by the adoption of the specially designed contact type rubber seal.
- (2) Consistent dust resistance is achieved without changing the contact surface pressure of the seal with respect to the bearing alignment.

3) Standard adoption of long-life grease

This bearing is filled with an ample amount of long-life grease to avoid the need for cleaning or filling the bearing with grease before assembling into the application.

- (1) Grease brand: Shell Alvania EP Grease 2 (8A) with extreme-pressure additive for heavy loads
- (2) Grease amount: Space volume ratio 15 to 25%

4) Standard adoption of oil holes

The bearing is able to be re-greased due to the oil grooves and oil holes that are standard in the outer ring.

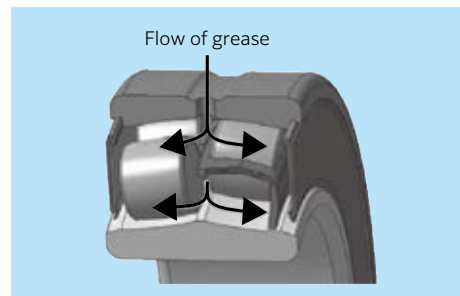
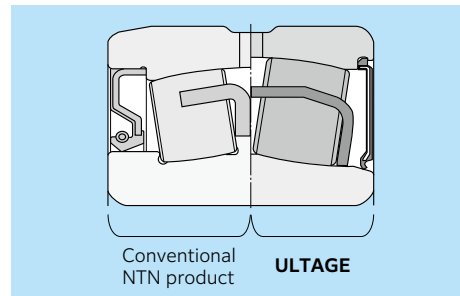

2. Part number

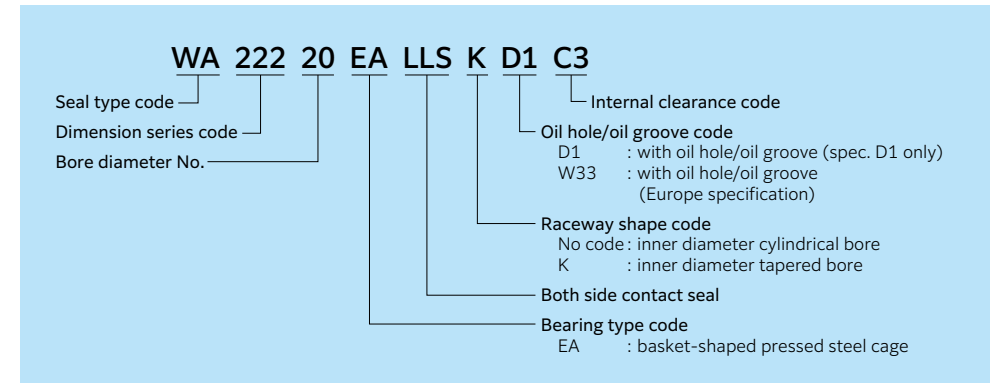

3. Allowable speed

When grease is supplied : $d_n \leq 6 \times 10^4$
 When no grease is supplied : $d_n \leq 8 \times 10^4$

* d_n value:
 $[d_n = \text{bearing bore diameter } d \text{ (mm)} \times \text{rotational speed } n \text{ (mm}^{-1}\text{)}]$

4. Allowable temperature range

Bearing temperature: $-20 \sim 110^\circ\text{C}$

5. Allowable misalignment angle

1/115 (mm/mm)

6. Handling precautions

- 1) The radial internal clearance on an ULTAGE series sealed spherical roller bearing with tapered bore cannot be measured with a clearance (thickness) gauge. Please manage the clearance after assembly by measuring the movement in the axial direction shown in **Table 15.1** (A-159) in section “15. Bearing handling.”
- 2) When the bearing misalignment exceeds the allowable misalignment (1/115), the rollers may come in contact with seal and cause seal deformation. It should be noted that the seal may come off when a large force is applied in this state.
- 3) Use Li-based mineral grease when re-greasing. Consult with **NTN Engineering** when using other types of grease.
- 4) When temperature mounting for assembly, the bearing temperature must be 100°C or below. The method of immersing bearings in hot oil cannot be used for this bearing type.

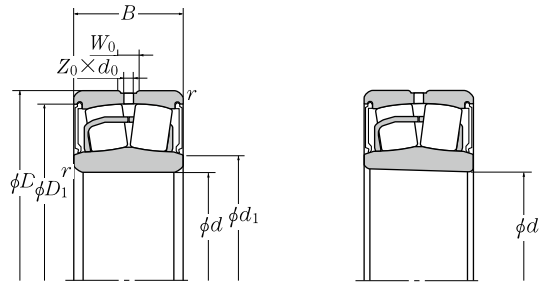

Number of oil holes on outer ring

Z ₀	
D1	W33
4	3

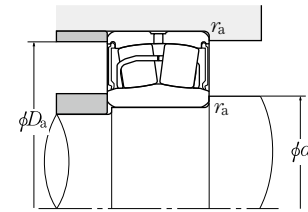

Dynamic equivalent radial load
 $P_r = X F_r + Y F_a$

$\frac{F_a}{F_r} \leq e$		$\frac{F_a}{F_r} > e$	
X	Y	X	Y
1	Y ₁	0.67	Y ₂

Static equivalent radial load

$$P_{0r} = F_r + Y_0 F_a$$

For values of e , Y_1 , Y_2 and Y_0 see the table below.

Boundary dimensions					Basic load rating			Fatigue load limit	Bearing number	
mm					dynamic	static	kn		Cylindrical bore	Tapered bore ²⁾
d	D	B	$r_{s \min}^{1)}$	W_0	d_0	C_r	C_{0r}	C_u		
25	52	23	1	3	1.5	57.3	46.1	3.23	WA22205EALLSW33/8A	—
30	62	25	1	4	2	75.7	64.5	4.58	WA22206EALLSW33/8A	—
35	72	28	1.1	5	2	100	92.0	6.11	WA22207EALLSW33/8A	WA22207EALLSKW33/8A
40	80	28	1.1	5	2.5	116	105	7.78	WA22208EALLSD1/8A	WA22208EALLSKD1/8A
45	85	28	1.1	6	2.5	121	113	8.76	WA22209EALLSD1/8A	WA22209EALLSKD1/8A
50	90	28	1.1	6	2.5	130	124	10.1	WA22210EALLSD1/8A	WA22210EALLSKD1/8A
55	100	31	1.5	6	3	155	148	12.6	WA22211EALLSD1/8A	WA22211EALLSKD1/8A
60	110	34	1.5	7	3	187	181	15.4	WA22212EALLSD1/8A	WA22212EALLSKD1/8A
65	120	38	1.5	8	3.5	226	224	18.2	WA22213EALLSD1/8A	WA22213EALLSKD1/8A
70	125	38	1.5	7	3.5	235	240	20.1	WA22214EALLSD1/8A	WA22214EALLSKD1/8A
75	130	38	1.5	7	3.5	244	249	21.1	WA22215EALLSD1/8A	WA22215EALLSKD1/8A
80	140	40	2	8	3.5	278	287	24.0	WA22216EALLSD1/8A	WA22216EALLSKD1/8A
85	150	44	2	8	3.5	324	330	27.1	WA22217EALLSD1/8A	WA22217EALLSKD1/8A
90	160	48	2	10	4.5	384	398	30.2	WA22218EALLSD1/8A	WA22218EALLSKD1/8A
95	170	51	2.1	10	4.5	416	417	33.4	WA22219EALLSD1/8A	WA22219EALLSKD1/8A
100	180	55	2.1	11	5	472	495	36.9	WA22220EALLSD1/8A	WA22220EALLSKD1/8A
110	200	63	2.1	12	6	602	643	45.0	WA22222EALLSD1/8A	WA22222EALLSKD1/8A
120	215	69	2.1	12	6	688	753	49.9	WA22224EALLSD1/8A	WA22224EALLSKD1/8A
130	230	75	3	13	6	808	898	56.6	WA22226EALLSD1/8A	WA22226EALLSKD1/8A

1) Smallest allowable dimension for chamfer dimension r .
 2) Indicates bearings with a tapered bore having a taper ratio of 1 / 12.

Installation-related dimensions					Constant	Axial load factors			Mass (approx.)		Amount of grease filled in (approx.)
mm						e	Y_1	Y_2	Y_0	Cylindrical bore	
d_1	$d_{a \min}$	$D_{a \max}$	D_1	$r_{s \max}$							
29	30	46	47	1	0.34	2.00	2.98	1.96	0.19	—	1.4 ~ 2.4
36	36	56	56	1	0.31	2.15	3.20	2.10	0.30	—	2.0 ~ 3.3
43	42	65	65	1.1	0.31	2.21	3.29	2.16	0.50	0.49	2.3 ~ 3.9
48	47	73	73	1.1	0.27	2.47	3.67	2.41	0.58	0.57	3.1 ~ 5.2
53	52	78	78	1.1	0.26	2.64	3.93	2.58	0.63	0.61	3.4 ~ 5.7
58	57	83	83	1.1	0.24	2.84	4.23	2.78	0.70	0.68	3.4 ~ 5.6
64	64	91	93	1.5	0.23	2.95	4.40	2.89	0.94	0.91	4.7 ~ 7.9
70	69	101	102	1.5	0.24	2.84	4.23	2.78	1.25	1.22	6.6 ~ 11.0
76	74	111	110	1.5	0.24	2.79	4.15	2.73	1.72	1.67	8.5 ~ 14.2
82	79	116	116	1.5	0.22	3.01	4.48	2.94	1.78	1.73	9.6 ~ 16.0
86	84	121	121	1.5	0.22	3.14	4.67	3.07	1.88	1.83	9.9 ~ 16.4
93	91	129	131	2	0.22	3.14	4.67	3.07	2.32	2.27	12.0 ~ 20.0
98	96	139	140	2	0.22	3.07	4.57	3.00	2.90	2.83	16.9 ~ 28.1
103	101	149	147	2	0.23	2.90	4.31	2.83	3.68	3.59	20.0 ~ 34.0
108	107	158	157	2.1	0.23	2.95	4.40	2.89	4.39	4.27	25.9 ~ 43.2
115	112	168	165	2.1	0.24	2.84	4.23	2.78	5.40	5.25	28.8 ~ 48.0
127	122	188	183	2.1	0.25	2.69	4.00	2.63	7.79	7.58	41.6 ~ 69.3
138	132	203	197	2.1	0.25	2.74	4.08	2.68	9.76	9.48	52.8 ~ 88.0
148	144	216	211	3	0.25	2.69	4.00	2.63	11.9	11.6	62.6 ~ 104.4



1. Features

The ULTAGE series spherical roller bearings with high-strength cage [EMA type] use dedicated machined brass cages. These bearings are suitable for mining machinery (vibrating screens, crushers, etc.), which experience eccentric rotation and impact loads.

2. Accuracy and clearance (specification for vibrating screens)

The inner and outer diameter tolerance and the radial internal clearance are set for vibrating screens to obtain the desired operating clearance. See the table below for the specifications of the ULTAGE series spherical roller bearings for the bearing specifications (accuracy, clearance, etc.) to be used with vibrating screens.

Design		
	Bearing series	223 series inner diameter 70 to 200 mm
	Roller	Symmetrical
	Cage type	Special machined cage

Unit: mm

Dimensional tolerance of mean bore diameter within plane				Dimensional tolerance of mean outside diameter within plane				Radial internal clearance (cylindrical bore)					
Nominal bearing bore diameter		VS1, VS2		Nominal bearing outside diameter		VS1, VS2		Nominal bearing bore diameter		VS1		VS2	
Over	Incl.	Upper	Lower	Over	Incl.	Upper	Lower	Over	Incl.	Min.	Max.	Min.	Max.
80		0	-0.010	150		-0.005	-0.013	65		0.075	0.090	0.100	0.120
80	120	0	-0.013	150	180	-0.005	-0.018	65	80	0.090	0.110	0.120	0.145
120	180	0	-0.015	180	315	-0.010	-0.023	80	100	0.110	0.135	0.150	0.180
180	200	0	-0.018	315	400	-0.013	-0.028	100	120	0.135	0.160	0.180	0.210
				400	420	-0.014	-0.030	120	140	0.160	0.190	0.205	0.240
								140	160	0.190	0.220	0.240	0.280
								160	180	0.200	0.240	0.260	0.310
								180	200	0.220	0.260	0.285	0.340

3. Part number

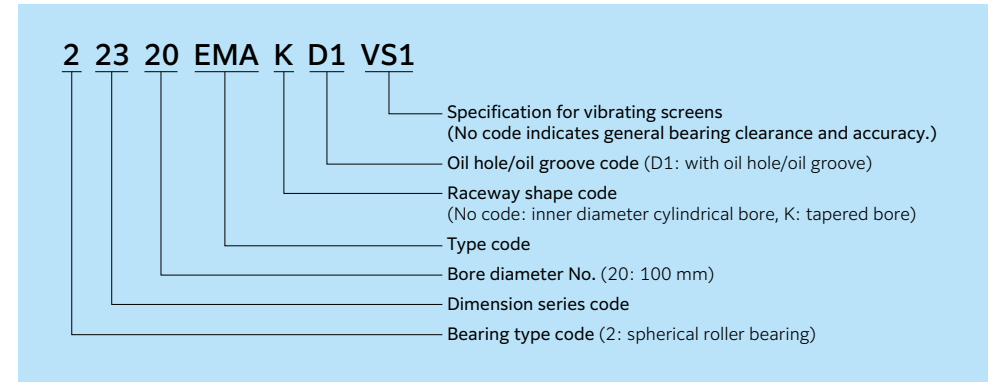

4. Allowable axial load

$$F_a / F_r \leq e$$

F_a : Axial load
 F_r : Radial load
 e : Constant (see dimension table)

If this bearing type is used under a large axial load, the load on the rollers of the row that is not subject to the axial load can become small. This small load on the rollers can result in skidding of the rollers, which can cause bearing damage. If the ratio of the radial load exceeds the factor e in the dimension table ($F_a / F_r > e$), consult NTN Engineering.

5. Allowable misalignment angle

Normal load or more 1/115 (mm/mm)
 Light load 1/30 (mm/mm)

*For a rough estimate of normal loads and light loads, see Note 1 in General Description A-81.

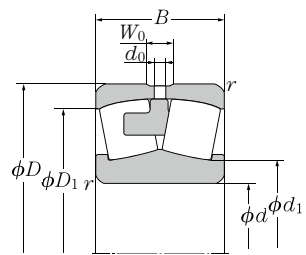

Cylindrical bore

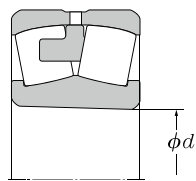

Tapered bore

Number of oil holes on outer ring

Nominal bearing outer diameter mm		Number of oil holes Z_0
Incl.	Below	
-	320	4
320	-	8

Boundary dimensions					Basic load rating		Allowable speed min ⁻¹ Oil lubrication	Bearing number
mm					dynamic	static		
d	D	B	r_s min ¹⁾	W_0	d_0	C_r	C_{0r}	Cylindrical bore
70	150	51	2.1	10	5	397	368	22314EMAD1
75	160	55	2.1	10	5	464	434	22315EMAD1
80	170	58	2.1	10	5	512	485	22316EMAD1
85	180	60	3	11	5	538	524	22317EMAD1
90	190	64	3	12	5	632	605	22318EMAD1
95	200	67	3	12	6	658	650	22319EMAD1
100	215	73	3	13	6	743	731	22320EMAD1
110	240	80	3	16	7	869	833	22322EMAD1
120	260	86	3	18	8	1 060	1 120	22324EMAD1
130	280	93	4	19	9	1 260	1 310	22326EMAD1
140	300	102	4	19	9	1 400	1 500	22328EMAD1
150	320	108	4	20	9	1 570	1 640	22330EMAD1
160	340	114	4	20	10	1 760	1 940	22332EMAD1
170	360	120	4	20	10	2 010	2 320	22334EMAD1
180	380	126	4	21	10	2 190	2 460	22336EMAD1
190	400	132	5	21	10	2 370	2 750	22338EMAD1
200	420	138	5	21	10	2 590	3 140	22340EMAD1

1) Smallest allowable dimension for chamfer dimension r .

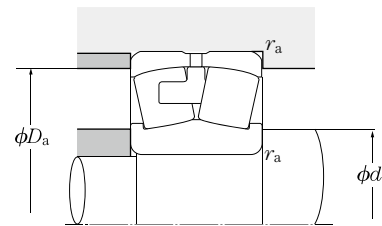

Dynamic equivalent radial load

$$P_r = X F_r + Y F_a$$

$\frac{F_a}{F_r} \leq e$		$\frac{F_a}{F_r} > e$	
X	Y	X	Y
1	Y_1	0.67	Y_2

Static equivalent radial load

$$P_{0r} = F_r + Y_0 F_a$$

For values of e , Y_1 , Y_2 and Y_0 see the table below.

Bearing number	Installation-related dimensions					Constant	Axial load factors				Mass (approx.) kg	
	mm						e	Y_1	Y_2	Y_0	Cylindrical bore	Tapered bore
Tapered bore ²⁾	d_1	d_a min	D_a max	D_1	r_{as} max							
22314EMAKD1	85	82	138	131	2.1	0.34	2.00	2.98	1.96	4.34	4.25	
22315EMAKD1	91	87	148	139	2.1	0.34	2.00	2.98	1.96	5.30	5.19	
22316EMAKD1	98	92	158	148	2.1	0.34	2.00	2.98	1.96	6.32	6.19	
22317EMAKD1	107	99	166	157	3	0.32	2.09	3.11	2.04	7.19	7.05	
22318EMAKD1	110	104	176	166	3	0.33	2.06	3.06	2.01	8.58	8.41	
22319EMAKD1	120	109	186	174	3	0.32	2.09	3.11	2.04	9.80	9.60	
22320EMAKD1	127	114	201	187	3	0.34	1.98	2.94	1.93	12.8	12.5	
22322EMAKD1	139	124	226	209	3	0.32	2.09	3.11	2.04	17.3	16.9	
22324EMAKD1	156	134	246	225	3	0.32	2.09	3.11	2.04	22.5	22.0	
22326EMAKD1	164	147	263	243	4	0.33	2.06	3.06	2.01	28.4	27.8	
22328EMAKD1	181	157	283	261	4	0.33	2.03	3.02	1.98	34.6	33.8	
22330EMAKD1	188	167	303	279	4	0.34	2.00	2.98	1.96	41.9	41.0	
22332EMAKD1	205	177	323	296	4	0.33	2.03	3.02	1.98	50.1	49.1	
22334EMAKD1	223	187	343	313	4	0.32	2.09	3.11	2.04	59.7	58.5	
22336EMAKD1	229	197	363	329	4	0.32	2.09	3.11	2.04	69.3	67.9	
22338EMAKD1	247	210	380	346	5	0.32	2.12	3.15	2.07	81.0	79.4	
22340EMAKD1	265	220	400	364	5	0.31	2.15	3.20	2.10	94.1	92.2	

2) Bearings having a tapered bore with a taper ratio of 1:12.

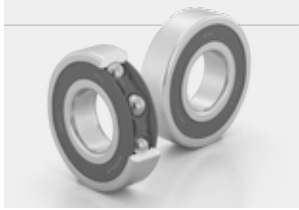

The ULTAGE series deep groove ball bearings for high-speed servo motors [MA type] are next-generation bearings with an optimized internal design for high-speed servo motors. These bearings have improved durability and longer grease life for high-speed operation and rapid acceleration/deceleration.

1. Features

1) High speed and high reliability

Deformation from high-speed operation is reduced and limiting speeds of $d_{mn} = 1$ million are achieved by using high performance cages. These cages are made of self-lubricating resin and have interlocking tabs for high rigidity (Fig. 1).

* d_{mn} value:

$$d_m \text{ (rolling element pitch diameter mm)} \times n \text{ (rotational speed min}^{-1}\text{)}$$

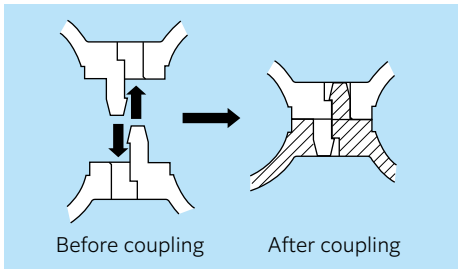

Fig.1 MA resin cage

2) Longer grease life

Outer ring grease pockets designed to maintain grease near the rolling elements improve lubrication reliability. In addition, long-life grease for motors "ME-1" (see Table 11.6 (A-116)) is applied for the initial grease fill.

(Longer life of five times or more is achieved compared with the lithium-based grease used for general purposes.)

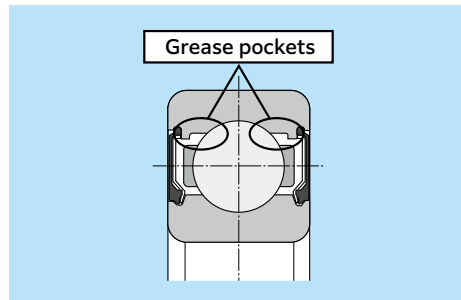

Fig. 2 Grease pockets

3) Low noise

A new resin interlocking cage design allows for low noise operation. The noise is reduced by 3 dB-A with respect to metal pressed cages.

Table 1 Measurement result of noise values

Specification	Noise value
Metal pressed cage	57 dB-A
ULTAGE product	54 dB-A

2. Part number

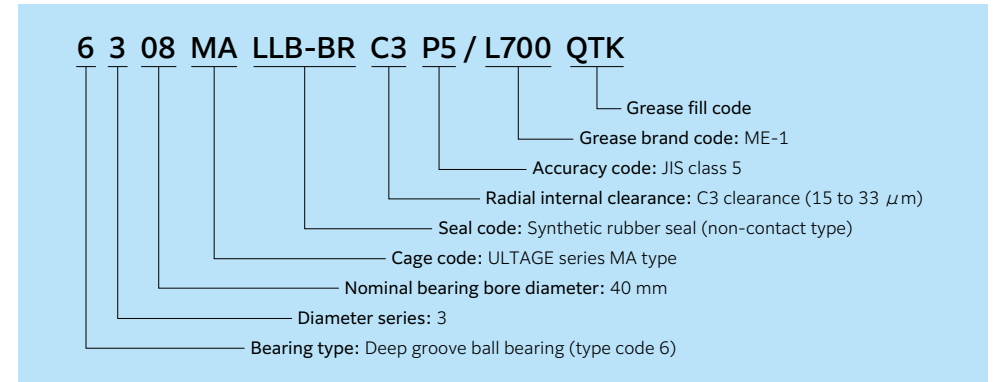

3. Operating temperature range

-20~120°C

4. Allowable speed

The allowable speed refers to a rotational speed of the bearing based on:

- Maximum outer ring temperature of 80°C
- Standard ME-1 grease filled to a fill volume of 15-20% of the free space.
- Spring preload is applied to the bearing.
- Bearing operation at room temperature after break-in procedure.

The bearing temperature increase differs depending on the usage condition (operating load, environmental temperature, rotational speed pattern, etc.); therefore, the bearings must be selected with sufficient allowable speed as specified in the catalog.

If the bearing will continuously operate above 80% of the limiting speed listed in the bearing dimension tables, please consult **NTN** Engineering.

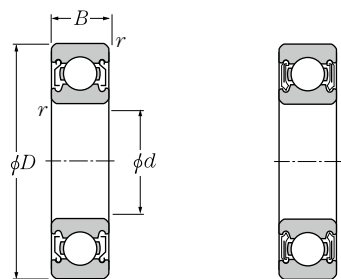

Shielded type (ZZ) Non-contact sealed type (LLB)

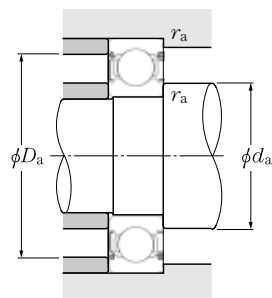

Boundary dimensions				Basic load rating		Fatigue load limit kN C _u	Factor f ₀	Allowable speed min ⁻¹ Grease lubrication ZZ, LLB	Bearing number	
mm				dynamic kN C _r	static kN C _{0r}				Shielded type	Non-contact sealed type
d	D	B	r _{s min} ¹⁾	C _r	C _{0r}					
40	90	23	1.5	45.0	24.0	1.83	13.2	15,400	6308MAZZ	6308MALLB
45	85	19	1.1	36.0	20.4	1.60	14.1	14,300	6209MAZZ	6209MALLB
50	90	20	1.1	39.0	23.2	1.82	14.4	15,400	6210MAZZ	6210MALLB
	110	27	2	68.5	38.5	2.99	13.2	12,200	6310MAZZ	6310MALLB
60	130	31	2.1	90.5	52.0	4.10	13.2	10,500	6312MAZZ	6312MALLB

1) Smallest allowable dimension for chamfer dimension r.

Dynamic equivalent radial load

$$P_r = X F_r + Y F_a$$

$\frac{f_0 \cdot F_a}{C_{0r}}$	e	$\frac{F_a}{F_r} \leq e$		$\frac{F_a}{F_r} > e$	
		X	Y	X	Y
0.172	0.19				2.30
0.345	0.22				1.99
0.689	0.26				1.71
1.03	0.28				1.55
1.38	0.30	1	0	0.56	1.45
2.07	0.34				1.31
3.45	0.38				1.15
5.17	0.42				1.04
6.89	0.44				1.00

Static equivalent radial load

$$P_{0r} = 0.6 F_r + 0.5 F_a$$

When $P_{0r} < F_r$, use $P_{0r} = F_r$.

Installation-related dimensions					Mass (approx.) kg
Min.	d _a	Max.	D _a Max.	r _{as}	
48		54	82	1.5	0.634
51.5		55.5	78.5	1	0.398
56.5		60	83.5	1	0.454
59		68.5	101	2	1.07
71		80.5	119	2	1.73

Note: For bearing models that are not specified in the list of series dimensions, please contact **NTN** Engineering.



Four-row cylindrical roller bearings

1. Features

- 1) The bearings are mainly used in the roll necks of steel rolling mills and designed so that the load rating is maximized in the allowable space of the roll neck part.
- 2) The cage types include a comb type cage and a pin type cage (that uses hollow rollers). The pin type cage maximizes the number of rollers for high load capacity.
- 3) Carburizing steel is used in some cases to prevent inner ring cracks and to improve shock resistance.
- 4) Consult **NTN** Engineering for bearing internal clearance and fits to be used for back-up rolls of rolling mills.
- 5) There are many varieties of these bearings, including bearings which are sealed, have tapered bores, designed for high speed, have creep prevention, etc. Contact **NTN** Engineering for further details.

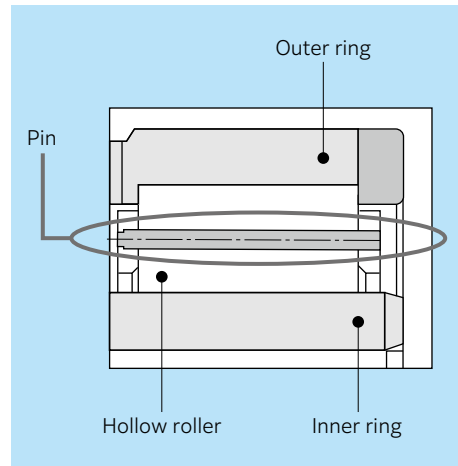

Pin type cage

2. Designs

Illustrations 1 to 7 show the several types of four-row cylindrical roller bearings that differ by the basic structure of inner rings, outer rings, and outer ring spacers.

The dimension table has the identification code (illustration + suffix code + oil groove code) specified in the illustration number column.

Example) In the case of illustration: 6, suffix code: M, oil groove code: ①, identification code "6M①" is specified in the illustration number column.

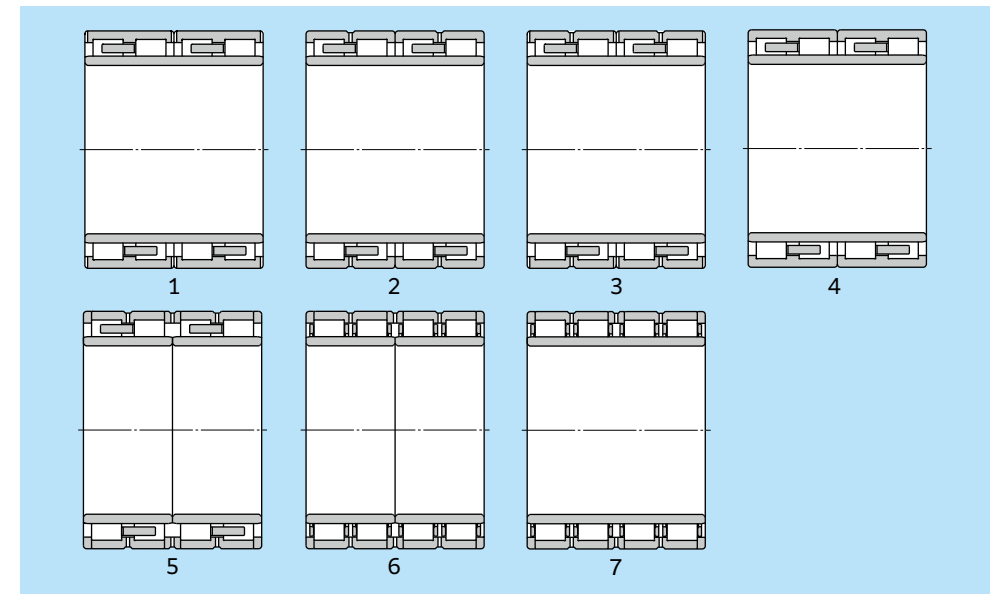

Design

Identification code

See the above illustrations 1 to 7.

- * Illustrations 1 to 5 use solid rollers + comb type machined cage.
- * Illustrations 6 to 7 use hollow rollers + pin type cage.

Suffix code

- M : The oil hole of the outer ring is provided with a fitting nozzle for oil mist.
- R : The inner diameter surface of the inner ring has a helical groove.
- S : Special specification

Oil groove code

- ① : Oil groove on both side faces of inner ring
- ② : Oil groove on one width surface of inner ring
- ③ : Oil groove on one width surface of outer ring
- ④ : No oil hole or oil groove on outer ring spacer

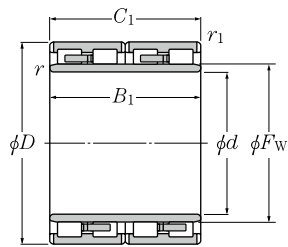

Drawings 1 to 5 ²⁾

d 100 ~ 170mm

d	Boundary dimensions					Basic load rating		Fatigue load limit kN C _u	Bearing number ²⁾	Drawing number ³⁾
	D	B ₁ mm	C ₁	r _{s min} ¹⁾	r _{1s min} ¹⁾	dynamic C _r kN	static C _{0r}			
100	150	74	74	2	2	291	510	58.5	4R2035	1
	180	92	92	2.5	2.5	445	785	84.5	4R2437	1
120	180	105	105	2.5	2.5	495	855	92.5	4R2438	1
	200	104	104	2.5	2.5	540	955	100	4R2628	1
140	190	119	119	1.5	1.5	550	1 190	125	4R2832	2 ²⁾
	210	116	116	2.5	2.5	565	1 030	106	4R2823	1
145	210	155	155	2.5	2.5	780	1 640	168	4R2906	1
	225	156	156	2.5	2.5	900	1 750	177	4R2904	1
150	220	127	120	2.5	2.5	685	1 280	129	4R3036	1
	220	150	150	2.5	2.5	830	1 640	167	4R3031	1
	220	150	150	2.5	2.5	830	1 640	167	4R3056	1
	230	130	130	2.5	2.5	800	1 520	153	4R3029	1
	230	156	156	2.5	2.5	1 030	2 040	204	4R3040	1
	230	168	168	2	2	935	1 950	194	4R3042	1
	250	150	150	2.5	2.5	985	1 640	162	4R3039	1
151.5	230	168	168	1.5	2.5	945	2 060	205	4R3033K	1
160	220	180	180	2.5	2.5	1 020	2 490	250	4R3224	1
	230	130	130	2.5	2.5	740	1 340	133	4R3226	1
	230	168	168	2.5	2.5	1 020	2 170	217	4R3232	1
	230	168	168	2.5	2.5	995	2 200	220	4R3229	1
	230	168	168	2.5	2.5	990	2 210	219	4R3231	1
	230	180	180	2.5	2.5	1 020	2 490	250	4R3228	4 ³⁾
170	240	170	170	2	2.5	1 090	2 290	227	4R3225	1
	230	120	120	2.5	2.5	685	1 520	151	4R3426	1
	230	120	120	2	2	685	1 520	151	4R3443	3
	240	156	156	2.5	2.5	1 000	2 170	213	4R3429	1
	240	160	160	2.5	2.5	1 000	2 180	213	4R3423	1
	250	168	168	2.5	2.5	1 080	2 220	216	4R3432	1
	250	168	168	2.5	2.5	1 140	2 390	232	4R3428	1
	255	180	180	2.5	2.5	1 220	2 430	236	4R3425	1
260	150	150	2.5	2.5	925	1 750	171	4R3433	1	

1) Smallest allowable dimension for chamfer dimension r or r₁.

2) Bearings marked "K" have a tapered bore with a taper ratio of 1:12.

3) Boundary dimension parts are shown in the above drawing. Refer to C-19 for the details of drawings.

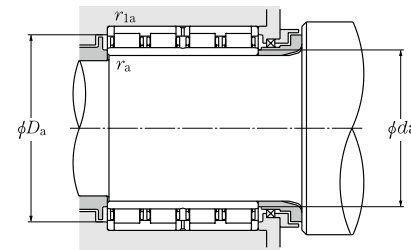

Dimensions	Installation-related dimensions					Mass kg (approx.)
	F _w	d _a	D _a	r _{as}	r _{1as}	
115	109	141	2	2	4.68	
137	131	169	2	2	8.2	
135	131	169	2	2	9.3	
150	141	189	2	2	12.1	
154	148	182	1.5	1.5	9.93	
160	151	199	2	2	13.9	
166	156	199	2	2	18	
169	156	214	2	2	23.3	
168	161	209	2	2	15.7	
168	161	209	2	2	19.4	
168	161	209	2	2	19.6	
174	161	219	2	2	20	
174	161	219	2	2	24.5	
178	159	221	2	2	25.8	
177	161	239	2	2	29.6	
179	159.5	219	1.5	2	25.4	
177	171	209	2	2	20.2	
180	171	219	2	2	16.6	
179	171	219	2	2	23.4	
180	171	219	2	2	23.2	
182	171	219	2	2	23.2	
177	171	219	2	2	24.8	
183	169	229	2	2	27.8	
187	181	219	2	2	14.2	
187	179	221	2	2	14.6	
189	181	229	2	2	22.2	
190	181	229	2	2	22.8	
193	181	239	2	2	28.2	
193	181	239	2	2	28.5	
193	181	244	2	2	19.3	
192	181	249	2	2	29.5	

Four-Row Cylindrical Roller Bearings

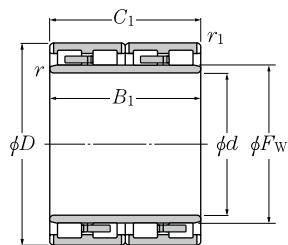

Drawings 1 to 5 ²⁾

d 170 ~ 230mm

d	Boundary dimensions					Basic load rating		Fatigue load limit kN C _u	Bearing number	Drawing number ²⁾
	D	B ₁ mm	C ₁	r _{s min} ¹⁾	r _{1s min} ¹⁾	dynamic C _r kN	static C _{0r}			
170	260	225	225	2.5	2.5	1 450	3 150	305	4R3431	1
180	250	156	156	2.5	2.5	995	2 180	211	4R3625	1
	250	168	168	2	2	980	2 470	239	4R3639	1
	260	168	168	2.5	2.5	1 130	2 400	230	4R3628	1
	265	180	180	2.5	2.5	1 200	2 510	241	4R3618	1
190	260	168	168	2.5	2.5	1 080	2 600	248	4R3820	1
	270	170	170	2.5	2.5	1 210	2 660	252	4R3818	1
	270	200	200	2.5	2.5	1 400	3 100	292	4R3821	1
	270	200	200	2.5	2.5	1 360	3 200	305	4R3817	1
	280	200	200	2.5	2.5	1 370	2 910	274	4R3823	2
280	200	200	2.5	2.5	1 370	2 910	274	4R3830	3	
200	270	170	170	2.5	2.5	1 080	2 610	245	4R4039	1
	280	152	152	2.1	2.1	1 110	2 320	217	4R4054	2 ²⁾
	280	170	170	2.5	2.5	1 150	2 430	228	4R4048	1
	280	190	190	2.5	2.5	1 320	3 150	294	4R4026	1
	280	200	200	2.5	2.5	1 460	3 300	310	4R4037	1
	280	200	200	2.5	2.5	1 380	3 350	310	4R4027	1
290	192	192	2.5	2.5	1 430	3 150	292	4R4041	1	
210	290	192	192	2.5	2.5	1 370	3 350	310	4R4206	1
220	290	192	192	2.5	2.5	1 320	3 350	310	4R4413	1
	300	160	160	2.5	2.5	1 110	2 590	237	4R4419	1
	300	160	160	2.1	2.1	1 110	2 590	237	4R4445	3
	310	192	192	2.5	2.5	1 500	3 550	320	4R4410	1
	310	192	192	2.5	2.5	1 540	3 400	310	4R4426	1
	310	204	204	2.5	2.5	1 570	3 750	340	4R4425	1
	310	215	215	2.5	2.5	1 690	3 750	340	4R4420	1
	310	225	225	2.5	2.5	1 640	3 950	360	4R4416	1
	310	225	225	2.5	2.5	1 760	3 950	360	4R4449	1
	320	160	160	3	3	1 320	2 550	231	4R4428	1
	320	210	210	2.5	2.5	1 720	3 650	325	4R4429	1
	320	210	210	2.5	2.5	1 720	3 600	330	4R4444	1
230	330	206	206	2.5	2.5	1 680	3 900	345	4R4610	1
	330	206	206	2.5	2.5	1 690	3 800	340	4R4614	1

1) Smallest allowable dimension for chamfer dimension r or r₁.

2) Boundary dimension parts are shown in the above drawing. Refer to C-19 for the details of drawings.

Four-Row Cylindrical Roller Bearings

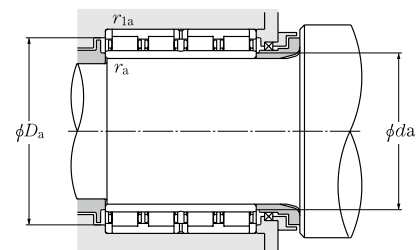

Dimensions	Installation-related dimensions					Mass kg (approx.)
	F _w	d _a	D _a	r _{as}	r _{1as}	
196	181	249	2	2	44	
200	191	239	2	2	23.2	
202	189	241	2	2	25.6	
202	191	249	2	2	29.4	
204	191	254	2	2	34.2	
212	201	249	2	2	26.9	
213	201	259	2	2	31.7	
212	201	259	2	2	37.5	
212	201	259	2	2	37.2	
214	201	269	2	2	41.5	
214	201	269	2	2	42.8	
222	211	259	2	2	28.5	
222	211	269	2	2	29.5	
222	211	269	2	2	33	
223	211	269	2	2	36.7	
222	211	269	2	2	40.5	
224	211	269	2	2	38.8	
226	211	279	2	2	42.5	
236	221	279	2	2	39.5	
239	231	279	2	2	33.8	
245	231	289	2	2	32.8	
245	231	289	2	2	33.7	
247	231	299	2	2	46.3	
246	231	299	2	2	46.9	
247	231	299	2	2	49.8	
242	231	299	2	2	51.5	
245	231	299	2	2	54.9	
244	231	299	2	2	54.3	
245	233	307	2.5	2.5	46.5	
248	231	309	2	2	60.5	
246	231	309	2	2	57.3	
260	241	319	2	2	58.3	
258	241	319	2	2	58.6	

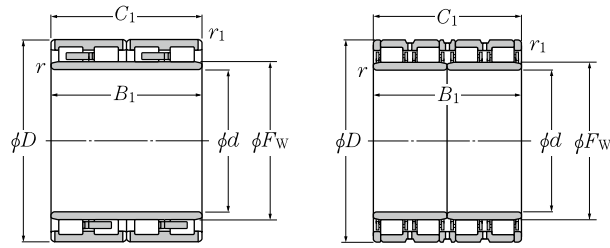

Drawings 1 to 5²⁾

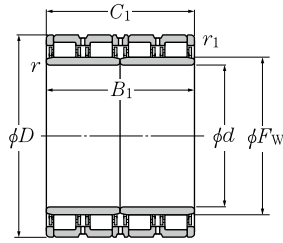

Drawings 6²⁾

d 230 ~ 300mm

d	Boundary dimensions					Basic load rating		Fatigue load limit kN C _u	Bearing number	Drawing number ²⁾
	D	B ₁ mm	C ₁	r _s min ¹⁾	r _{1s} min ¹⁾	dynamic C _r	static C _{0r}			
230	340	260	260	3	3	2 270	5 100	455	4R4611	1
240	330	220	220	3	3	1 650	4 150	365	4R4811	3
	330	220	220	3	3	1 790	4 250	380	4R4819	1
	330	220	220	3	3	1 650	4 150	365	4R4821	3
	340	220	220	3	3	1 690	4 250	375	4R4804	1
	340	220	220	3	3	1 850	4 200	370	4R4806	1
250	360	220	220	2.5	2.5	1 950	4 050	355	4R4807	1
	360	220	220	2.5	2.5	1 950	4 050	355	4R4813	1
260	350	220	220	3	3	1 920	4 300	375	4R5008	1
	360	220	200	2.5	2.5	1 710	4 150	360	4R5221	4
	360	260	260	2.5	2.1	2 030	4 850	420	4R5231	3 ^①
	370	220	220	3	3	1 950	4 450	385	4R5208	1
	370	220	220	3	3	1 950	4 450	385	4R5217	1 ^①
265	380	280	280	3	3	2 680	6 250	535	4R5213	1
	400	290	290	4	2	3 400	7 150	610	4R5218	5 ^④
270	370	234	234	1.5	1.5	2 250	5 000	425	4R5306	1 ^①
	380	280	280	2.5	2.5	2 510	5 750	490	4R5407	1
280	380	280	280	2.5	2.5	2 860	6 850	585	4R5405	6 ^④
	350	208	208	2.5	2.5	1 430	3 950	345	4R5614	1
	390	220	220	3	3	1 970	4 650	395	4R5611	1
	390	220	220	3	3	2 020	4 800	405	4R5604	1
	390	275	275	2.5	2.5	2 540	6 250	525	4R5612	4 ^③
290	420	280	280	4	4	2 700	6 150	515	4R5605	1
	410	240	240	3	3	2 480	5 550	465	4R5806	1
300	420	300	300	3	3	3 150	7 500	625	4R5805	1
	400	300	300	3	3	2 750	7 500	—	E-4R6014	1
	420	240	240	3	3	2 240	5 450	—	E-4R6017	1 ^①
	420	240	240	3	3	2 240	5 450	—	E-4R6012	1
	420	240	240	3	3	2 230	5 450	—	E-4R6023	1 ^①
	420	240	240	3	3	2 530	5 750	—	E-4R6027	1
	420	300	300	3	3	3 300	8 150	—	E-4R6030	6 ^①

1) Smallest allowable dimension for chamfer dimension r or r₁.

2) Boundary dimension parts are shown in the above drawing. Refer to C-19 for the details of drawings.

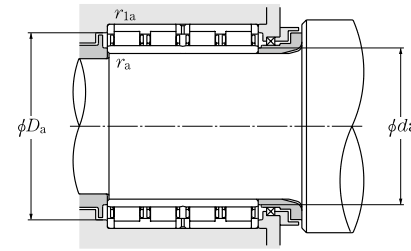

Dimensions	Installation-related dimensions					Mass kg (approx.)
	F _w	d _a	D _a	r _{as}	r _{1as}	
261	243	327	2.5	2.5	82.6	
270	253	317	2.5	2.5	56.8	
264	253	317	2.5	2.5	57.1	
268	253	317	2.5	2.5	57.1	
270	253	317	2.5	2.5	57.1	
268	253	327	2.5	2.5	63.6	
274	251	349	2	2	79.6	
274	251	349	2	2	80.1	
278	263	337	2.5	2.5	66	
292	271	349	2	2	62.7	
287	271	349	2	2	81.5	
292	273	357	2.5	2.5	77.1	
292	273	357	2.5	2.5	76.5	
294	273	367	2.5	2.5	109	
296	276	391	3	2	135	
300	273	362	1.5	1.5	78.9	
297	281	369	2	2	101	
299.7	281	369	2	2	105	
298	291	339	2	2	46.4	
312	293	377	2.5	2.5	81.3	
312	293	377	2.5	2.5	82	
312	291	379	2	2	105	
323	296	404	3	3	139	
320	303	397	2.5	2.5	103	
327	303	407	2.5	2.5	141	
328	313	387	2.5	2.5	104	
334	313	407	2.5	2.5	106	
334	313	407	2.5	2.5	105	
336	313	407	2.5	2.5	105	
332	313	407	2.5	2.5	105	
331	313	407	2.5	2.5	136	

Four-Row Cylindrical Roller Bearings

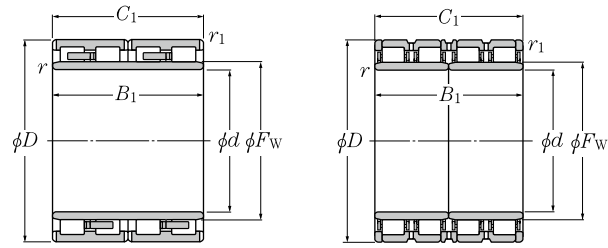

Drawings 1 to 5²⁾

Drawings 6 to 7²⁾

d 300 ~ 380mm

d	Boundary dimensions					Basic load rating		Fatigue load limit kN C_u	Bearing number ²⁾	Drawing number ³⁾
	D	B_1 mm	C_1	r_s min ¹⁾	r_{1s} min ¹⁾	dynamic C_r kN	static C_{0r} kN			
300	420	300	300	3	3	3 000	7 600	—	E-4R6015	1
	420	300	300	3	3	3 200	7 850	—	E-4R6020	6 ^①
	420	320	300	3	3	3 200	7 850	—	E-4R6018	6 ^②
	430	240	240	3	3	2 400	5 150	—	E-4R6021	1
	460	270	270	3	3	2 780	5 350	—	E-4R6019	1
310	430	240	240	3	3	2 480	5 950	—	E-4R6202	1
320	440	240	230	3	3	2 540	6 050	—	E-4R6414	1
	450	240	240	3	3	2 630	6 150	—	E-4R6411	1
	460	340	340	3	3	3 750	9 450	—	E-4R6412	1
	470	350	350	3	3	4 600	10 900	—	E-4R6406	6 ^④
330	440	200	200	3	3	2 020	4 850	—	E-4R6603	2
	440	200	200	5	3	1 910	4 550	—	E-4R6608	2 ^①
	460	340	340	4	4	3 600	8 850	—	E-4R6605	1
	460	340	340	4	4	3 650	9 550	—	E-4R6602	1
340	480	350	350	4	4	4 400	10 900	—	E-4R6819	6M ^①
	480	370	350	5	5	3 800	9 650	—	E-4R6811	1
	490	300	300	4	4	3 700	8 300	—	E-4R6804	1
	490	300	300	5	5	3 450	7 950	—	E-4R6805	1
356.76	550	400	400	4	4	5 650	13 800	—	E-4R7105K	5
360	480	290	290	3	3	3 300	8 150	—	E-4R7207	1
	510	370	370	4	4	3 950	9 700	—	E-4R7212	3
	510	400	380	4	2	4 850	11 900	—	E-4R7205	5 ^①
	510	400	400	5	5	4 700	11 500	—	E-4R7203	2
370	480	230	230	5	5	2 330	6 250	—	E-4R7405	1
	480	250	250	3	3	2 440	6 450	—	E-4R7408	1
	520	380	380	5	5	4 350	10 800	—	E-4R7411	1
	520	400	400	5	5	5 150	13 500	—	E-4R7404	1
380	520	280	280	4	4	3 800	9 150	—	E-4R7605	1
	520	290	290	4	4	3 800	9 150	—	E-4R7617	1
	520	300	300	4	4	3 950	9 600	—	E-4R7607	7 ^①
	540	400	400	4	4	5 750	15 200	—	E-4R7604	7 ^②

1) Smallest allowable dimension for chamfer dimension r or r_1 .
 2) Bearings marked "K" have a tapered bore with a taper ratio of 1:12.
 3) Boundary dimension parts are shown in the above drawing. Refer to C-19 for the details of drawings.

Four-Row Cylindrical Roller Bearings

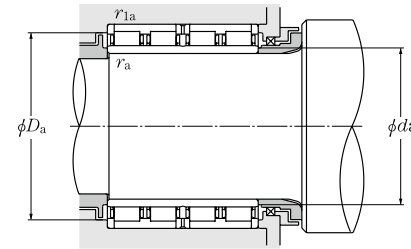

Dimensions	Installation-related dimensions					Mass kg (approx.)
	F_w	d_a	D_a	r_{as}	r_{1as}	
334	313	407	2.5	2.5	125	
332	313	407	2.5	2.5	130	
332	313	407	2.5	2.5	136	
338	313	417	2.5	2.5	115	
344	313	447	2.5	2.5	162	
344.5	323	417	2.5	2.5	108	
351	333	427	2.5	2.5	106	
358	333	437	2.5	2.5	125	
360	333	447	2.5	2.5	178	
361.7	333	457	2.5	2.5	212	
360	343	427	2.5	2.5	83.6	
360	350	427	4	2.5	85.6	
365	346	444	3	3	181	
368	346	444	3	3	177	
378	356	464	3	3	211	
378	360	460	4	4	198	
377	356	474	3	3	187	
380	360	470	4	4	189	
426	372.757	534	3	3	354	
388	373	467	2.5	2.5	148	
400	376	494	3	3	244	
399	376	509	3	2	251	
397	380	490	4	4	262	
400	390	460	4	4	106	
401	383	467	2.5	2.5	118	
409	390	500	4	4	256	
409	390	500	4	4	273	
417	396	504	3	3	174	
417	396	504	3	3	185	
416	396	504	3	3	210	
422	396	524	3	3	325	

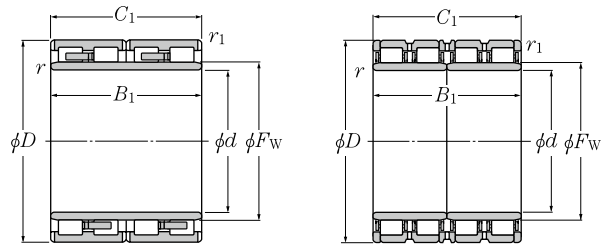

Drawings 1 to 4²⁾

Drawings 6 to 7²⁾

d 380 ~ 500mm

d	Boundary dimensions					Basic load rating		Fatigue load limit kN C _u	Bearing number	Drawing number ²⁾
	D	B ₁	C ₁	r _{s min} ¹⁾	r _{1s min} ¹⁾	dynamic C _r	static C _{0r}			
380	540	400	400	4	4	5 500	14 400	—	E-4R7618	6M ^①
	540	400	400	5	5	5 050	12 700	—	E-4R7613	2 ^{①③}
400	560	400	400	5	5	4 700	11 800	—	E-4R8007	2
	560	410	410	4	4	6 350	17 000	—	E-4R8010	6
	590	420	420	4	4	5 750	13 000	—	E-4R8011	1
420	560	280	280	4	4	3 500	8 750	—	E-4R8403	1
	580	230	230	4	4	2 700	6 250	—	E-4R8404	1
	600	440	440	6	2.5	7 050	18 100	—	E-4R8407	6 ^①
	620	400	400	5	5	5 550	13 400	—	E-4R8401	4 ^③
430	591	420	420	5	5	6 100	17 400	—	E-4R8605	6M ^{①④}
440	600	450	450	1.5	5	6 700	17 900	—	E-4R8806	6R ^②
	600	450	450	1.5	5	7 050	19 100	—	E-4R8805	6R ^①
	620	450	450	5	5	7 150	18 700	—	E-4R8803	6 ^①
	620	450	450	5	5	7 150	18 700	—	E-4R8801	6
460	620	400	400	4	4	5 900	16 700	—	E-4R9211	7S
	620	400	400	4	4	5 450	15 000	—	E-4R9209	1
	620	460	460	4	4	6 600	19 100	—	E-4R9223	6M ^①
	650	470	470	5	5	7 900	20 600	—	E-4R9216	6 ^①
470	660	470	470	5	5	8 100	21 300	—	E-4R9403	6M ^①
480	600	236	236	3	3	2 900	7 850	—	E-4R9610	1
	650	420	420	5	5	6 350	17 200	—	E-4R9613	7 ^①
	650	420	420	5	5	6 600	18 100	—	E-4R9607	7
	680	500	500	6	6	8 800	24 000	—	E-4R9604	6
500	680	420	405	5	5	7 900	22 900	—	E-4R10010	6 ^②
	680	420	405	5	5	7 000	18 800	—	E-4R10020	6 ^②
	690	470	470	5	5	8 500	22 500	—	E-4R10016	6 ^①
	690	510	510	5	5	8 550	24 600	—	E-4R10006	6
	700	515	515	5	5	8 750	24 100	—	E-4R10011	6
	710	480	480	6	6	9 600	24 700	—	E-4R10008	6 ^①
	720	530	530	5	5	9 150	25 000	—	E-4R10015	6 ^①
	720	530	530	5	5	9 150	25 000	—	E-4R10024	6M ^①

1) Smallest allowable dimension for chamfer dimension r or r₁.

2) Boundary dimension parts are shown in the above drawing. Refer to C-19 for the details of drawings.

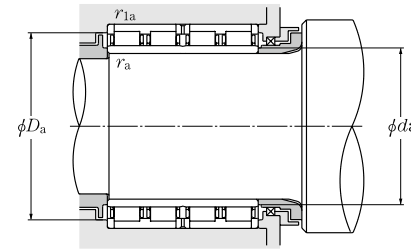

Dimensions	Installation-related dimensions					Mass kg (approx.)
	F _w	d _a	D _a	r _{as}	r _{1as}	
422	396	524	3	3	309	
424	400	520	4	4	298	
446	420	540	4	4	303	
445	416	544	3	3	349	
450	416	574	3	3	399	
457	436	544	3	3	189	
466	436	564	3	3	181	
469.6	444	589	5	2	423	
478	440	600	4	4	410	
476	450	571	4	4	362	
480	448	580	1.5	4	392	
480	448	580	1.5	4	392	
487	460	600	4	4	450	
487	460	600	4	4	437	
502	476	604	3	3	383	
502	476	604	3	3	341	
502	476	604	3	3	417	
509	480	630	4	4	540	
517	490	640	4	4	529	
510	493	587	2.5	2.5	155	
523	500	630	4	4	423	
523	500	630	4	4	369	
532	504	656	5	5	640	
550	520	660	4	4	495	
550	520	660	4	4	451	
547	520	670	4	4	590	
552	520	670	4	4	640	
554	520	680	4	4	680	
556	524	686	5	5	675	
568	520	700	4	4	780	
568	520	700	4	4	745	

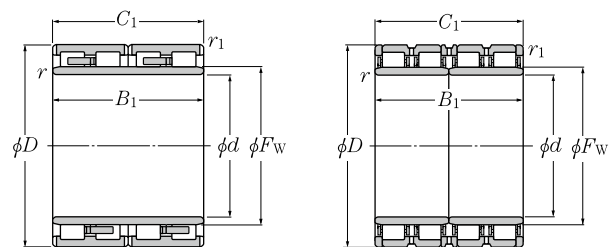

Drawings 1²⁾

Drawings 6 to 7²⁾

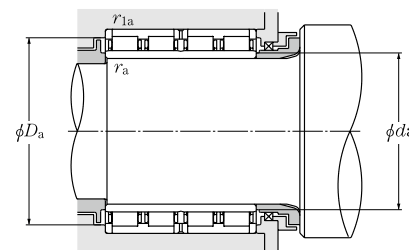

d 510 ~ 680mm

d	Boundary dimensions					Basic load rating		Fatigue load limit kN Cu	Bearing number	Drawing number ²⁾
	D	B1	C1	rs min ¹⁾	rs min ¹⁾	dynamic Cr	static Cor			
510	670	320	320	5	5	5 050	13 500	—	E-4R10201	7 ^①
	700	540	540	6	6	9 200	25 000	—	E-4R10202	6 ^①
520	700	540	540	6	6	9 100	25 500	—	E-4R10403	6 ^①
	720	550	550	5	5	10 400	27 700	—	E-4R10406	6R ^①
	735	535	535	5	5	9 950	26 600	—	E-4R10402	6 ^②
530	700	540	540	6	6	8 700	25 400	—	E-4R10603	6 ^①
	760	520	520	6	6	10 200	26 700	—	E-4R10601	6 ^①
	780	570	570	6	6	11 400	29 100	—	E-4R10602	6 ^①
	780	570	570	7.5	6	11 400	29 100	—	E-4R10606	6M ^①
536.18	762.03	558.8	558.8	5	6	11 200	29 200	—	E-4R10704	6 ^②
550	800	520	520	6	6	10 500	27 000	—	E-4R11001	6 ^①
560	680	360	360	3	3	5 150	16 500	—	E-4R11202	1
570	800	514	514	2.5	6	11 300	29 200	—	E-4R11404	6R ^①
	815	594	594	6	6	13 100	34 500	—	E-4R11402	6
600	820	575	575	7.5	7.5	11 100	31 500	—	E-4R12006	6M ^①
	870	540	540	7.5	7.5	11 800	29 600	—	E-4R12002	6 ^①
	870	640	640	7.5	7.5	15 100	40 500	—	E-4R12001	6
610	870	660	660	9.5	7.5	14 000	40 000	—	E-4R12202	6 ^{①④}
628	922	600	600	3	6	15 100	38 500	—	E-4R12602	6 ^①
640	880	600	600	6	6	12 700	36 000	—	E-4R12802	6 ^②
650	920	670	670	7.5	4	16 200	46 000	—	E-4R13005	6 ^①
	920	680	680	7.5	7.5	16 600	47 000	—	E-4R13010	6R ^①
	920	690	690	7.5	7.5	15 900	46 500	—	E-4R13003	6
660	820	440	440	5	4	8 100	27 800	—	E-4R13201	6
	680	1 020	650	650	6	6	17 400	48 000	—	E-4R13603
		1 020	680	680	3	5	19 200	49 500	—	E-4R13604

1) Smallest allowable dimension for chamfer dimension r or r1.

2) Boundary dimension parts are shown in the above drawing. Refer to C-19 for the details of drawings.

Dimensions	Installation-related dimensions					Mass kg (approx.)
	Fw	da	Da	ras	r1as	
554	530	650	4	4	335	
558	534	676	5	5	689	
564	544	676	5	5	658	
566	540	700	4	4	715	
574.5	540	715	4	4	740	
574	554	676	5	5	626	
590	554	736	5	5	800	
601	554	756	5	5	1 010	
595	562	756	6	5	978	
600	556.176	738.03	4	5	859	
622	574	776	5	5	965	
590	573	667	2.5	2.5	265	
626	581	776	2	5	849	
628	594	791	5	5	1 040	
660	632	788	6	6	941	
672	632	838	6	6	1 150	
672	632	838	6	6	1 330	
680	650	838	8	6	1 400	
702	641	898	2.5	5	1 430	
700	664	856	5	5	1 150	
723	682	904	6	3	1 500	
723	682	888	6	6	1 510	
723	682	888	6	6	1 550	
702	680	804	4	3	580	
803	704	996	5	5	1 970	
775	693	1 000	2.5	4	2 060	

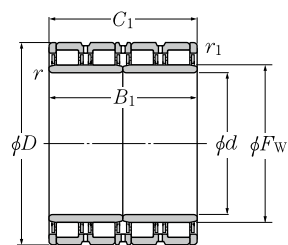

Drawings 6²⁾

d 690 ~ 860mm

d	Boundary dimensions					Basic load rating		Fatigue load limit kN C _u	Bearing number ³⁾	Drawing number ²⁾
	D	B ₁ mm	C ₁	r _s min ¹⁾	r _{1s} min ¹⁾	C _r	C _{0r}			
690	980	715	715	7.5	7.5	18 700	54 500	—	E-4R13802	6 ²⁾
	980	750	750	7.5	7.5	18 300	53 000	—	E-4R13803	6M ²⁾
710	1 000	715	715	9.5	6	18 600	54 500	—	E-4R14205	6S ⁴⁾
725	1 000	700	700	6	6	17 700	53 500	—	E-4R14501	6 ¹⁾
750	1 050	745	720	7.5	7.5	19 500	58 000	—	E-4R15001	6M ²⁾
	1 090	745	720	7.5	7.5	21 200	60 500	—	E-4R15002	6M ²⁾
755	1 070	750	750	7.5	7.5	20 800	58 500	—	E-4R15101	6 ¹⁾
760	1 030	750	750	7.5	7.5	19 200	59 500	—	E-4R15204	6M ¹⁾
	1 080	805	790	6	6	20 700	61 000	—	E-4R15207	6M ²⁾
	1 100	745	720	7.5	7.5	21 200	60 500	—	E-4R15203	6M ²⁾
761.43	1 079.6	787.4	787.4	9.5	7.5	21 900	63 000	—	E-4R15201	6 ¹⁾
800	1 080	700	700	7.5	7.5	18 300	55 000	—	E-4R16004	6 ¹⁾
	1 080	750	750	6	6	19 200	59 000	—	E-4R16005	6 ¹⁾
820	1 130	800	800	7.5	7.5	21 800	66 500	—	E-4R16406	6M ¹⁾
	1 130	800	800	7.5	7.5	23 900	72 000	—	E-4R16413	6MS ²⁾
	1 130	800	800	7.5	7.5	21 800	66 500	—	E-4R16415	6 ²⁾
	1 130	825	800	7.5	7.5	21 800	66 500	—	E-4R16405	6M ¹⁾
	1 160	840	840	7.5	7.5	24 000	71 000	—	E-4R16403	6 ²⁾
830	1 080	710	710	6	6	18 000	59 500	—	E-4R16601	6 ²⁾
840	1 160	840	840	5	7.5	23 900	71 000	—	E-4R16801	6 ¹⁾
850	1 150	650	650	9.5	9.5	17 500	51 000	—	E-4R17001	6 ¹⁾
	1 150	800	800	6	6	21 800	71 000	—	E-4R17003	6 ¹⁾
	1 150	840	840	6	6	24 400	77 500	—	E-4R17009	6 ¹⁾
	1 180	650	650	7.5	7.5	18 200	51 500	—	E-4R17004	6 ¹⁾
	1 180	850	850	9.5	9.5	26 700	78 500	—	E-4R17002	6
	1 180	850	850	7.5	7.5	24 100	72 000	—	E-4R17014	6 ²⁾
860	1 140	750	750	7.5	7.5	19 100	61 000	—	E-4R17202	6 ²⁾

1) Smallest allowable dimension for chamfer dimension r or r₁.

2) Boundary dimension parts are shown in the above drawing. Refer to C-19 for the details of drawings.

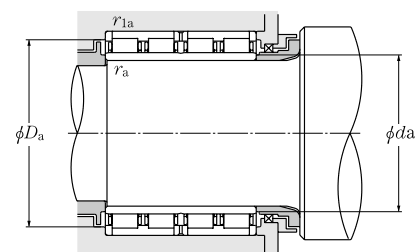

Dimensions	Installation-related dimensions					Mass kg (approx.)
	F _w	d _a	D _a	r _{as}	r _{1as}	
767.5	722	948	6	6	1 850	
766	722	948	6	6	1 900	
787.5	750	976	8	5	1 900	
796	749	976	5	5	1 730	
830	782	1 018	6	6	2 180	
845	782	1 058	6	6	2 530	
837	787	1 038	6	6	2 260	
828	792	998	6	6	2 000	
845	784	1 056	5	5	2 550	
855	792	1 068	6	6	2 560	
846	801.425	1 047.6	8	6	2 420	
870	832	1 048	6	6	1 950	
880	824	1 056	5	5	2 090	
903	852	1 098	6	6	2 450	
903	852	1 098	6	6	2 530	
903	852	1 098	6	6	2 530	
903	852	1 098	6	6	2 520	
910	852	1 128	6	6	2 930	
896	854	1 056	5	5	1 780	
920	860	1 128	4	6	2 840	
941	890	1 110	8	8	1 980	
930	874	1 126	5	5	2 430	
928	874	1 126	5	5	2 640	
945	882	1 148	6	6	2 270	
928	890	1 140	8	8	2 970	
940	882	1 148	6	6	2 980	
938	892	1 108	6	6	2 200	

● Four-Row Cylindrical Roller Bearings

NTN

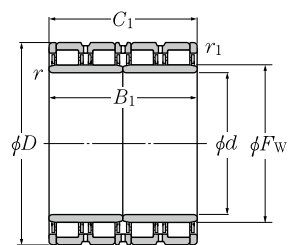

Drawings 6²⁾

d 860 ~ 1 030mm

d	Boundary dimensions					Basic load rating		Fatigue load limit kN C _u	Bearing number	Drawing number ²⁾
	D	B ₁ ^{mm}	C ₁	r _{s min} ¹⁾	r _{1s min} ¹⁾	dynamic C _r kN	static C _{0r}			
860	1 160	735	710	6	6	19 700	62 500	—	E-4R17201	6 ^①
900	1 230	895	870	7.5	7.5	27 400	88 000	—	E-4R18001	6M ^②
920	1 280	865	850	7.5	7.5	29 100	88 500	—	E-4R18401	6
1000	1 310	880	880	9.5	9.5	25 900	88 500	—	E-4R20001	6 ^①
	1 360	800	800	7.5	7.5	27 700	85 000	—	E-4R20002	6 ^①
1030	1 380	850	850	7.5	7.5	27 100	89 000	—	E-4R20601	6 ^①

● Four-Row Cylindrical Roller Bearings

NTN

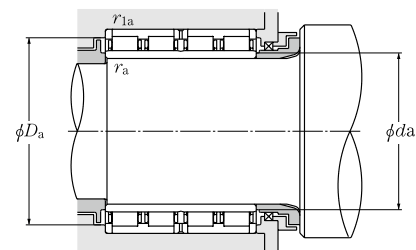

Dimensions	Installation-related dimensions					Mass kg (approx.)
	F _w	d _a	D _a	r _{as}	r _{1as}	
940	884	1 136	5	5	2 310	
985	932	1 198	6	6	3 250	
1 015	952	1 248	6	6	3 560	
1 080	1 040	1 270	8	8	3 260	
1 090	1 032	1 328	6	6	3 530	
1 124	1 062	1 348	6	6	3 800	

1) Smallest allowable dimension for chamfer dimension r or r₁.

2) Boundary dimension parts are shown in the above drawing. Refer to C-19 for the details of drawings.



Four-row tapered roller bearings

1. Features

- 1) This type of bearing includes two double-row inner rings with rollers, one double-row outer ring, two single-row outer rings, and two outer ring spacers (**Fig. 1 TYPE B**). There is also a type with an inner ring spacer (**Fig. 1 TYPE A**). These bearings are manufactured so that the internal clearance values are fixed. Due to this, only parts with identical manufacturing numbers can be used, and they must be assembled according to their code numbers.
- 2) These bearings are mainly used in the roll necks of steel rolling mills and designed so that the load rating is maximized in the allowable space of the roll neck part.
- 3) Loose fitting is used to make the assembly and removal of the bearings easy. Carburizing steel is used to prevent inner ring cracks due to creeping and to improve shock resistance. There is also a bearing design with a helical groove in the inner ring bore to prevent wear.
- 4) The cage type includes a pressed steel cage and a pin type cage (that uses a hollow roller as shown in **Fig. 2**). The pin type cage maximizes the number of rollers in the bearing to provide increased load capacity.

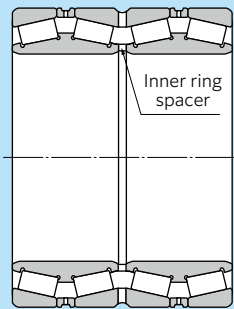

(TYPE A)
With inner ring spacer

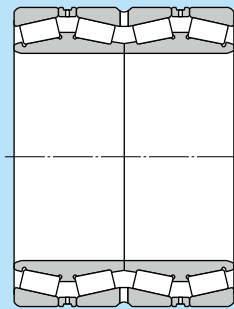

(TYPE B)
Without inner ring spacer

Fig. 1

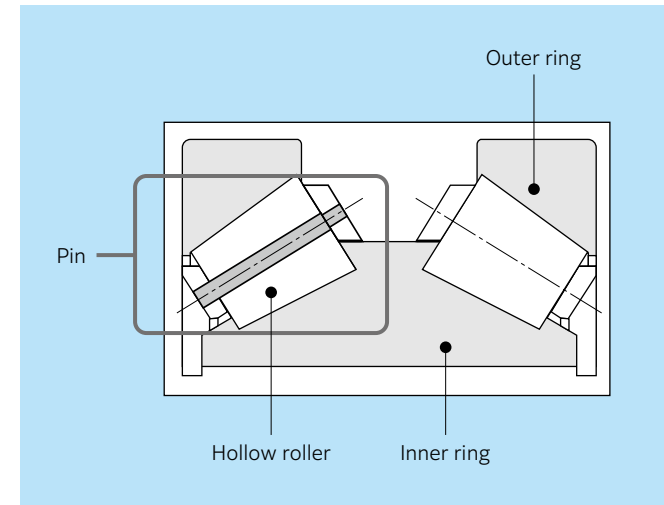

Fig. 2 Pin type cage

Inch series tapered roller bearings (four-row) index

Series number	Bearing number CONE / CUP	Page of bearing dimension table	Series number	Bearing number CONE / CUP	Page of bearing dimension table
8500	T-8576D / 8520 / 8520D	C-42	M257200	M257248D / M257210 / M257210D	C-46
9900	9974D / 9920 / 9920D	C-42	LM258600	LM258649D / LM258610 / LM258610D	C-46
46700	T-46791D / 46720 / 46721D	C-40	HM259000	T-HM259049D / HM259010 / HM259010D	C-46
48200	T-48290D / 48220 / 48220D	C-40	HM261000	HM261049D / HM261010 / HM261010DA	C-48
48300	T-48393D / 48320 / 48320D	C-40	M262400	M262449D / M262410 / M262410D	C-48
48600	T-48680D / 48620 / 48620D	C-40	HM262700	T-HM262749D / HM262710 / HM262710DG2	C-48
67700	67791D / 67720 / 67721D	C-40	LM263100	LM263149D / LM263110 / LM263110D	C-48
67800	T-67885D / 67820 / 67820D	C-42	M263300	M263349D / M263310 / M263310D	C-48
67900	T-67986D / 67920 / 67921D	C-42	HM265000	HM265049D / HM265010 / HM265010DG2	C-48
81000	81576D / 81962 / 81963D	C-40	HM266400	T-HM266449D / HM266410 / HM266410DG2	C-50
82600	82681D / 82620 / 82620D	C-40	M268700	T-M268749D / M268710 / M268710DG2	C-50
126000	EE126096D / 126150 / 126151D	C-44	M270700	M270749D / M270710 / M270710DG2	C-50
127000	EE127097D / 127137 / 127137D	C-42	LM272200	LM272249D / LM272210 / LM272210DG2	C-52
132000	EE132082D / 132125 / 132126D	C-42	M274100	M274149D / M274110 / M274110DG2	C-52
134000	EE134102D / 134143 / 134144D	C-44	LM274400	LM274449D / LM274410 / LM274410D	C-52
135000	EE135111D / 135155 / 135156D	C-44	275000	EE275106D / 275155 / 275156D	C-44
L163100	T-L163149D / L163110 / L163110D	C-48	275000	EE275109D / 275160 / 275161D	C-44
170000	EE171000D / 171450 / 171451D	C-44	M275300	M275349D / M275310 / M275310DG2	C-52
180000	EE181455D / 182350 / 182351D	C-48	M276400	M276449D / M276410 / M276410DG2	C-52
220000	EE221027D / 221575 / 221576D	C-44	M278700	M278749D / M278710 / M278710DAG2	C-54
M224700	T-M224749D / M224710 / M224710D	C-40	280000	EE280703D / 281200 / 281201D	C-40
M231600	T-M231649D / M231610 / M231610D	C-40	M280000	M280049D / M280010 / M280010DG2	C-54
234000	T-EE234161D / 234215 / 234216D	C-50	M280300	M280349D / M280310 / M280310DG2	C-54
M238800	T-M238849D / M238810 / M238810D	C-42	L281100	L281149D / L281110 / L281110DG2	C-54
M240600	M240648D / M240611 / M240611D	C-42	M283400	M283449D / M283410 / M283410DG2	C-54
M241500	T-M241538D / M241510 / M241510D	C-42	LM283600	LM283649D / LM283610 / LM283610DG2	C-54
244000	EE244181D / 244235 / 244236D	C-52	M284100	M284148D / M284111 / M284210DG2	C-56
M244200	T-M244249D / M244210 / M244210D	C-42	M284200	M284249D / M284210 / M284210DG2	C-56
LM247700	LM247748D / LM247710 / LM247710DA	C-44	M285800	M285848D / M285810 / M285810DG2	C-56
M249700	T-M249748D / M249710 / M249710D	C-44	LM286200	LM286249D / LM286210 / LM286210DG2	C-56
HM252300	T-HM252349D / HM252310 / HM252310D	C-44	LM287600	LM287649D / LM287610 / LM287610DG2	C-56
M252300	T-M252349D / M252310 / M252310D	C-44	290000	EE291202D / 291750 / 291751D	C-46
M255400	M255449D / M255410 / M255410DA	C-46	329000	EE329119D / 329172 / 329173D	C-46
HM256800	T-HM256849D / HM256810 / HM256810DG2	C-46	LM377400	LM377449D / LM377410 / LM377410DG2	C-54
M257100	M257149D / M257110 / M257110D	C-46	LM451300	T-LM451349D / LM451310 / LM451310D	C-44

Inch series tapered roller bearings (four-row) index

Series number	Bearing number CONE / CUP	Page of bearing dimension table	Series number	Bearing number CONE / CUP	Page of bearing dimension table
526000	EE526131D / 526190 / 526191D	C-48	931000	EE931170D / 931250 / 931251XDG2	C-50
531000	EE531201D / 531300 / 531301XDG2	C-52	970000	EE971355D / 972100 / 972103D	C-48
547000	EE547341D / 547480 / 547481DG2	C-56			
640000	T-EE640193D / 640260 / 640261DG2	C-52			
649000	EE649241D / 649310 / 649311DG2	C-54			
LM654600	T-LM654644D / LM654610 / LM654610D	C-44			
LM654600	T-LM654648D / LM654610 / LM654610D	C-44			
655000	EE655271D / 655345 / 655346DG2	C-54			
LM665900	LM665949D / LM665910 / LM665910D	C-50			
M667900	M667947D / M667911 / M667911DG2	C-50			
700000	EE700090D / 700167 / 700168D	C-42			
722000	EE722111D / 722185 / 722186D	C-44			
724000	EE724121D / 724195 / 724196D	C-46			
736000	EE736173D / 736238 / 736239D	C-50			
737000	EE737179D / 737260 / 737260D	C-52			
LM742700	T-LM742749D / LM742714 / LM742714D	C-42			
755000	EE755280D / 755360 / 755361DG2	C-54			
M757400	M757448D / M757410 / M757410D	C-46			
M757400	M757449D / M757410 / M757410D	C-46			
LM761600	LM761648D / LM761610 / LM761610D	C-48			
LM761600	LM761649D / LM761610 / LM761610D	C-48			
LM763400	LM763449D / LM763410 / LM763410D	C-48			
LM765100	LM765149D / LM765110 / LM765110D	C-48			
LM767700	LM767745D / LM767710 / LM767710D	C-50			
LM767700	LM767749D / LM767710 / LM767710D	C-50			
LM769300	LM769349D / LM769310 / LM769310D	C-50			
L770800	L770849D / L770810 / L770810DG2	C-52			
LM772700	LM772749D / LM772710 / LM772710DA	C-52			
LM778500	LM778549D / LM778510 / LM778510DG2	C-54			
822000	EE822101D / 822175 / 822176D	C-44			
833000	EE833161D / 833232 / 833233D	C-50			
843000	EE843221D / 843290 / 843291D	C-54			
LM869400	T-LM869449D / LM869410 / LM869410DG2	C-50			
910000	EE911603D / 912400 / 912401D	C-50			
920000	EE921150D / 921875 / 921876D	C-46			

Four-Row Tapered Roller Bearings

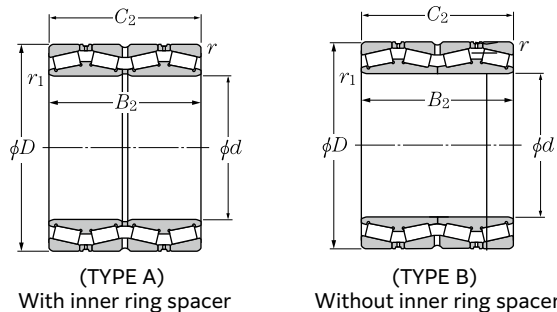

Four-Row Tapered Roller Bearings

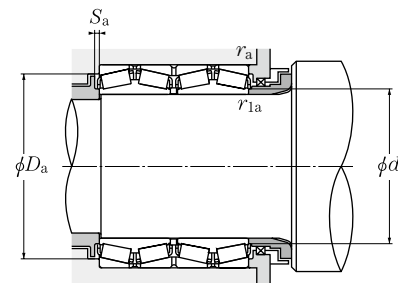

Dynamic equivalent radial load

$$P_r = X F_r + Y F_a$$

$\frac{F_a}{F_r} \leq e$		$\frac{F_a}{F_r} > e$	
X	Y	X	Y
1	Y ₁	0.67	Y ₂

Static equivalent radial load

$$P_{0r} = F_r + Y_0 F_a$$

For values of e , Y_1 , Y_2 and Y_0 see the table below.

d 120 ~ 177.800mm

d	Boundary dimensions				Basic load rating		Bearing number a) to d)		
	D	B ₂	C ₂	r _{s min} ¹⁾ / r _{1s min} ¹⁾	dynamic	static	(TYPE A) With inner ring spacer		
	mm				kN				
120	170	124	124	2	2.5	430	1 020	*	E-625924
	180	100	100	2	2.5	435	745	*	E-623024
	200	132	132	2	2.5	710	1 220	*	E-623124
	210	174	174	2.5	2.5	950	1 710	*	E-CRO-2418
120.650	174.625	141.288	139.703	1.5	0.8	670	1 490	◎ *	T-E-M224749D/M224710/M224710D
127	182.562	158.750	158.750	3.3	1.5	730	1 730	◎ *	T-E-48290D/48220/48220D
130	184	134	134	2	2.5	535	1 190	*	E-625926
135	180	160	160	2	1	555	1 360	*	E-CRO-2701
136.525	190.500	161.925	161.925	3.3	1.5	770	1 900	◎ *	T-E-48393D/48320/48320D
139.700	200.025	157.165	160.340	3.3	0.8	780	1 950	◎ *	T-E-48680D/48620/48620D
140	198	144	144	2	2.5	640	1 460	*	E-625928
	210	114	114	2	2.5	570	1 070	*	E-623028
	210	115	115	2	2.5	570	1 070	*	E-CRO-2817
146.050	244.475	192.088	187.325	3.3	1.5	1 060	1 980	◎ *	E-81576D/81962/81963D
150	212	155	155	2.5	3	735	1 700	*	E-625930
152.400	222.250	174.625	174.625	1.5	1.5	1 030	2 350	◎ *	T-E-M231649D/M231610/M231610D
160	226	165	165	2.5	3	855	2 030	*	E-625932
	265	173	173	2.5	2.5	1 220	2 270	*	E-CRO-3209
165.100	225.425	165.100	168.275	3.3	0.8	830	2 220	◎ *	T-E-46791D/46720/46721D
170	240	175	175	2.5	3	930	2 200	*	E-625934
	260	144	144	2.5	3	930	1 730	*	E-623034
	280	185	185	2.5	3	1 380	2 540	*	E-623134
177.800	247.650	192.088	192.088	3.3	1.5	1 110	2 760	◎ *	E-67791D/67720/67721D
	279.400	234.950	234.947	3.3	1.5	1 570	3 400	◎ *	E-82681D/82620/82620D
	304.800	238.227	233.365	3.3	3.3	1 750	3 100	◎ *	E-EE280703D/281200/281201D

1) Smallest allowable dimension for chamfer dimension r or r_1 .

Bearing number a) to d)	Installation-related dimensions					Constant	Axial load factors			Mass
	d _a	D _a	mm S _a Min.	r _{as} Max.	r _{1as} Max.		e	Y ₁	Y ₂	
E-CRO-2451	135	151	5	2	2	0.33	2.03	3.02	1.98	8.97
	137	162.5	3.8	2	2	0.37	1.80	2.69	1.76	8.87
	143.6	176	4.1	2	2	0.37	1.80	2.69	1.76	16.7
	143	178	4.5	2	2	0.40	1.68	2.50	1.64	22.2
	129	162	3	1.5	0.8	0.33	2.03	3.02	1.98	11.5
	137	168	4.5	3.3	1.5	0.31	2.21	3.29	2.16	14.3
	144.3	164	5	2	2	0.33	2.03	3.02	1.98	11.3
	144.7	161.5	2	2	1	0.33	2.03	3.02	1.98	13.5
	144	177	4	3.3	1.5	0.32	2.10	3.13	2.06	14.8
	150	185	3	3.3	0.8	0.34	2.01	2.99	1.96	17.3
	155.8	178	5	2	2	0.33	2.03	3.02	1.98	14
	160.7	187	3.5	2	2	0.37	1.84	2.74	1.80	13.8
	159.1	187.5	3.4	2	2	0.37	1.84	2.74	1.80	13.9
	163	225	6.5	3.3	1.5	0.35	1.92	2.86	1.88	36.8
	167.5	190	5.5	2	2.5	0.33	2.03	3.02	1.98	16.9
	164.5	207	4	1.5	1.5	0.33	2.03	3.02	1.98	24.7
E-CRO-3210	177.5	202.5	5.5	2	2.5	0.33	2.03	3.02	1.98	20.2
	190	231	4.5	2	2	0.33	2.03	3.02	1.98	37
	175	209	3	3.3	0.8	0.38	1.76	2.62	1.72	20.7
	187.5	213	5.5	2	2.5	0.33	2.03	3.02	1.98	24.4
	194.8	232	3.8	2	2.5	0.37	1.80	2.69	1.76	27.5
	196.4	254	6.4	2	2.5	0.37	1.80	2.69	1.76	45.2
E-CRO-3664	192.2	217.5	5	3.3	1.5	0.44	1.54	2.29	1.50	29.4
	195	251	5	3.3	1.5	0.53	1.28	1.91	1.25	55.3
E-CRO-3663	206.2	274.5	7	3.3	3.3	0.36	1.87	2.79	1.83	69.9

a) Bearing numbers marked "◎" designate inch series bearings. b) When adopting bearings with bearing numbers marked with "*", please consult NTN Engineering. c) Bearing numbers marked "⋆" designate bearings with hollow rollers and pin type cages. d) Contact NTN Engineering for bearing numbers (TYPE B) without an inner ring spacer that are not listed.

Four-Row Tapered Roller Bearings

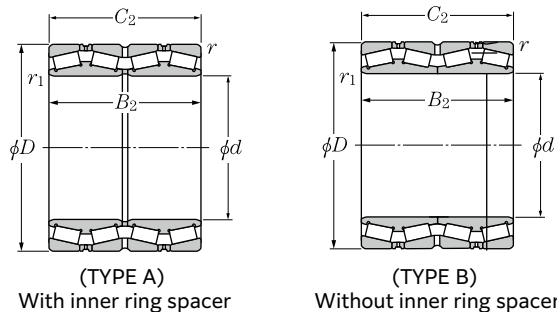

Four-Row Tapered Roller Bearings

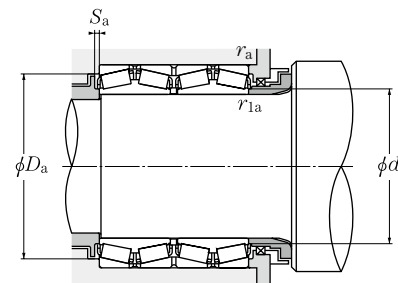

Dynamic equivalent radial load

$$P_r = X F_r + Y F_a$$

$\frac{F_a}{F_r} \leq e$		$\frac{F_a}{F_r} > e$	
X	Y	X	Y
1	Y ₁	0.67	Y ₂

Static equivalent radial load

$$P_{0r} = F_r + Y_0 F_a$$

For values of e , Y_1 , Y_2 and Y_0 see the table below.

d 180 ~ 241.478mm

d	Boundary dimensions				Basic load rating				Bearing number a) to d)
	mm				dynamic static				
	D	B ₂	C ₂	r _{s min} ¹⁾ r _{1s min} ¹⁾	C _r	C _{0r}	a) b) c)	(TYPE A) With inner ring spacer	
180	254	185	185	2.5 3	1 010	2 390	*	T-E-625936	
187.325	269.875	211.138	211.138	3.3 1.5	1 490	3 500	◎ *	T-E-M238849D/M238810/M238810D	
190	268	196	196	2.5 3	1 170	2 850	*	E-625938	
	270	190	190	2.5 0.6	1 350	3 050	*	E-CRO-3813	
	292.100	225.425	225.425	3.3 1.5	1 740	4 150	◎ *	T-E-M241538D/M241510/M241510D	
190.500	266.700	187.325	188.912	3.3 1.5	1 160	2 990	◎ *	T-E-67885D/67820/67820D	
198.438	284.162	225.425	225.425	3.3 1.5	1 690	4 000	◎	E-M240648D/M240611/M240611D	
200	282	206	206	2.5 3	1 330	3 300		E-625940	
	290	160	160	2.5 2.5	1 060	2 210		E-CRO-4013	
203.200	317.500	215.900	209.550	3.3 3.3	1 400	2 820	◎	E-EE132082D/132125/132126D	
206.375	282.575	190.500	190.500	3.3 0.8	1 180	3 150	◎	T-E-67986D/67920/67921D	
215.900	288.925	177.800	177.800	3.3 0.8	1 240	3 250	◎	T-E-LM742749D/LM742714/LM742714D	
216.103	330.200	263.525	269.875	3.3 1.5	2 220	5 150	◎	E-9974D/9920/9920D	
220	300	230	230	2.5 2.5	1 500	3 650		E-CRO-4412	
	310	226	226	3 4	1 530	3 800		E-625944	
	320	200	200	3 1	1 540	3 400		E-CRO-4411	
	340	190	190	3 4	1 670	3 300		E-623044	
220.662	314.325	239.712	239.712	3.3 1.5	2 040	4 900	◎	T-E-M244249D/M244210/M244210D	
228.600	364.000	296.875	296.875	3.3 3.3	2 630	5 550		E-CRO-4606	
	425.450	349.250	361.950	6.4 3.5	3 850	8 250	◎	E-EE700090D/700167/700168D	
234.950	327.025	196.850	196.850	3.3 1.5	1 550	3 800	◎	T-E-8576D/8520/8520D	
240	338	248	248	3 4	2 080	4 950		E-625948A	
241.478	350.838	228.600	228.600	3.3 1.5	1 790	4 000	◎	E-EE127097D/127137/127137D	

1) Smallest allowable dimension for chamfer dimension r or r_1 .

Bearing number a) to d)	Installation-related dimensions					Constant e	Axial load factors			Mass (approx.) kg
	d_a	D_a	mm S_a Min.	r_{as} Max.	r_{1as} Max.		Y_1	Y_2	Y_0	
(TYPE B) Without inner ring spacer	200.5	227	5.5	2	2.5	0.33	2.03	3.02	1.98	28.9
	200	254	4	3.3	1.5	0.33	2.03	3.02	1.98	41.8
	211	238	6	2	2.5	0.33	2.03	3.02	1.98	34.7
	207.2	248.5	2	2	0.6	0.40	1.68	2.50	1.64	34.5
	222	271	5	3.3	1.5	0.33	2.03	3.02	1.98	59.6
E-CRO-3814	208	234	3	3.3	1.5	0.48	1.41	2.11	1.38	33.6
	212.1	263.9	5.5	3.3	1.5	0.33	2.03	3.02	1.98	46
	219.5	260.5	6	2	2.5	0.33	2.03	3.02	1.98	40.5
	224	267.5	5	2	2	0.37	1.80	2.69	1.76	35.1
	224	293.9	9.5	3.3	3.3	0.31	2.15	3.20	2.10	62.5
	223	260	5	3.3	0.8	0.51	1.33	1.97	1.30	35.4
	229.4	267	5	3.3	0.8	0.48	1.40	2.09	1.37	34.3
	235	300	6	3.3	1.5	0.55	1.23	1.82	1.20	82.1
	236.5	277.5	6.5	2	2	0.43	1.59	2.36	1.55	42.1
	242	284.5	6	2.5	3	0.33	2.03	3.02	1.98	53.5
	245	297	6.5	2.5	1	0.35	1.95	2.90	1.91	53
	250.5	315	5.5	2.5	3	0.37	1.80	2.69	1.76	63.2
E-CRO-4442	239.5	288.5	4	3.3	1.5	0.33	2.03	3.02	1.98	60.2
	262	334.5	6.5	3.3	3.3	0.32	2.12	3.15	2.07	117.9
	259	381	3	6.4	3.5	0.33	2.03	3.02	1.98	232
E-CRO-4704	256	301	5	3.3	1.5	0.41	1.66	2.47	1.62	53.6
E-CRO-4825	260.5	312	6	2.5	3	0.33	2.03	3.02	1.98	70
	258	325	6.5	3.3	1.5	0.35	1.91	2.85	1.87	76.4

a) Bearing numbers marked "◎" designate inch series bearings. b) When adopting bearings with bearing numbers marked with "*", please consult NTN Engineering. c) Bearing numbers marked "⊗" designate bearings with hollow rollers and pin type cages. d) Contact NTN Engineering for bearing numbers (TYPE B) without an inner ring spacer that are not listed.

Four-Row Tapered Roller Bearings

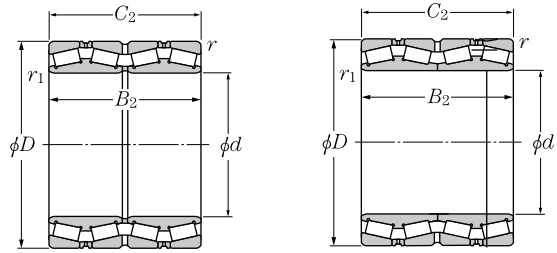

(TYPE A)
With inner ring spacer

(TYPE B)
Without inner ring spacer

d 244.475 ~ 285.750mm

d	Boundary dimensions				Basic load rating				Bearing number a) to d)
	mm				dynamic static kN				
	D	B ₂	C ₂	r _{s min} ¹⁾	r _{1s min} ¹⁾	C _r	C _{0r}	a) b) c)	(TYPE A) With inner ring spacer
244.475	327.025	193.675	193.675	3.3	1.5	1 580	4 100	◎	E-LM247748D/LM247710/LM247710DA
	381.000	304.800	304.800	4.8	3.3	2 470	5 750	◎	E-EE126096D/126150/126151D
245	380	255.5	254	6.4	1.5	2 280	4 750		E-CRO-4901
254	358.775	269.875	269.875	3.3	3.3	2 650	6 550	◎	T-E-M249748D/M249710/M249710D
	368.300	204.622	204.470	3.3	1.5	1 500	3 250	◎	E-EE171000D/171450/171451D
	444.500	279.400	279.400	6.4	3.3	3 200	5 900	◎	E-EE822101D/822175/822176D
260	360	272	272	2.5	1	2 300	5 750		E-CRO-5218
	368	268	268	4	5	2 210	5 700		E-625952
	400	220	220	4	5	2 180	4 400		E-623052
	400	255	255	7.5	4	2 450	5 300		E-CRO-5215
260.350	365.125	228.600	228.600	6.4	3.3	1 940	4 550	◎	E-EE134102D/134143/134144D
	400.050	255.588	253.995	6.4	1.5	2 320	4 950	◎	E-EE221027D/221575/221576D
	422.275	314.325	317.500	3.3	6.4	3 800	7 100	◎	T-E-HM252349D/HM252310/HM252310D
266.700	355.600	230.188	228.600	3.3	1.5	2 040	5 350	◎	T-E-LM451349D/LM451310/LM451310D
	355.600	230.188	228.600	3.3	1.5	1 580	4 350		E-CRO-5305
	393.700	269.878	269.878	6.4	3.3	2 340	6 000	◎	E-EE275106D/275155/275156D
269.875	381.000	282.575	282.575	3.3	3.3	2 890	6 850	◎	T-E-M252349D/M252310/M252310D
270	410	222	222	4	4	2 120	4 550		E-CRO-5403
276.225	406.400	268.290	260.355	6.4	1.5	2 340	6 000	◎	E-EE275109D/275160/275161D
279.400	381.000	269.875	269.875	3.3	1.5	2 490	6 450		E-CRO-5628
	393.700	269.875	269.875	6.4	1.5	2 150	5 350	◎	E-EE135111D/135155/135156D
	469.900	346.075	349.250	3.3	6.4	3 850	8 700	◎	E-EE722111D/722185/722186D
279.578	380.898	244.475	244.475	3.3	1.5	2 160	6 200	◎	T-E-LM654644D/LM654610/LM654610D
280	380	290	290	3.1	1.7	2 740	7 250		E-CRO-5650
	395	288	288	4	5	2 840	7 100		E-625956
285.750	380.898	244.475	244.475	3.3	1.5	2 160	6 200	◎	T-E-LM654648D/LM654610/LM654610D

1) Smallest allowable dimension for chamfer dimension r or r₁.

Four-Row Tapered Roller Bearings

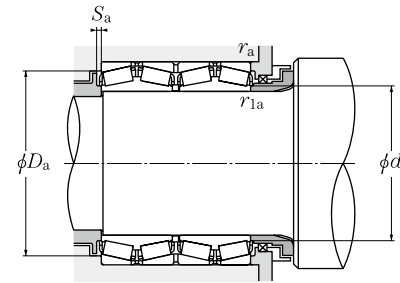

Dynamic equivalent radial load

$$P_r = X F_r + Y F_a$$

$\frac{F_a}{F_r} \leq e$		$\frac{F_a}{F_r} > e$	
X	Y	X	Y
1	Y ₁	0.67	Y ₂

Static equivalent radial load

$$P_{0r} = F_r + Y_0 F_a$$

For values of e, Y₁, Y₂ and Y₀ see the table below.

Bearing number a) to d)	Installation-related dimensions					Constant e	Axial load factors			Mass kg (approx.)
	d _a	D _a	mm S _a Min.	r _{as} Max.	r _{1as} Max.		Y ₁	Y ₂	Y ₀	
E-CRO-4905	265	306	5	3.3	1.5	0.32	2.09	3.11	2.04	46.1
	269	343	6.5	4.8	3.3	0.52	1.31	1.95	1.28	132
	275.5	349	6.5	6.4	1.5	0.37	1.80	2.69	1.76	106.7
E-CRO-5307	272	335	5	3.3	3.3	0.33	2.03	3.02	1.98	85.6
	269	340	6	3.3	1.5	0.36	1.85	2.75	1.81	71.8
	281.9	404.9	8	6.4	3.3	0.34	1.98	2.94	1.93	185
	279	335	6.5	2.5	1	0.41	1.66	2.47	1.62	74.2
E-CRO-5409	290	338.5	6	3	3	0.33	2.03	3.02	1.98	90.3
	292	370	6.5	3	3	0.37	1.80	2.69	1.76	98.9
	293.5	360.5	8	6	3	0.39	1.71	2.54	1.67	106
	280	339	6.5	6.4	3.3	0.37	1.80	2.69	1.76	76.5
E-CRO-5679	292	366	8	6.4	1.5	0.39	1.71	2.54	1.67	117
	290	356	5.5	3.3	6.4	0.33	2.03	3.02	1.98	180
	285	331.5	6.5	3.3	1.5	0.36	1.87	2.79	1.83	62
	287	333	3.5	3.3	1.5	0.37	1.83	2.72	1.79	62.3
E-CRO-5679	290	366	5	6.4	3.3	0.40	1.68	2.50	1.64	116
	291.5	351	6	3.3	3.3	0.33	2.03	3.02	1.98	97.5
	308	375.5	6	3	3	0.27	2.49	3.71	2.43	91
	293.6	373	8	6.4	1.5	0.40	1.68	2.50	1.64	122
E-CRO-5679	298.5	355.5	5	3.3	1.5	0.37	1.80	2.69	1.76	79.6
	297	368	6.5	6.4	1.5	0.40	1.68	2.50	1.64	103
	314	430	5	3.3	6.4	0.38	1.78	2.65	1.74	258
	304.5	350.5	5	3.3	1.5	0.43	1.56	2.33	1.53	83.2
E-CRO-5676	301	353.5	6.5	2.5	1.5	0.33	2.03	3.02	1.98	105
	304.5	363.5	7	3	4	0.33	2.03	3.02	1.98	111
E-CRO-5710	304.5	350.5	5	3.3	1.5	0.43	1.56	2.33	1.53	82.5

a) Bearing numbers marked "◎" designate inch series bearings. b) When adopting bearings with bearing numbers marked with "*", please consult NTN Engineering. c) Bearing numbers marked "S" designate bearings with hollow rollers and pin type cages. d) Contact NTN Engineering for bearing numbers (TYPE B) without an inner ring spacer that are not listed.

Four-Row Tapered Roller Bearings

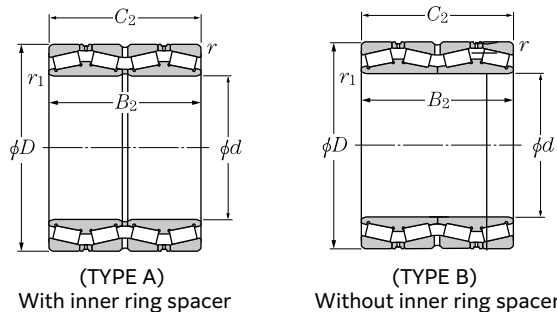

(TYPE A)
With inner ring spacer

(TYPE B)
Without inner ring spacer

d 288.925 ~ 330mm

d	Boundary dimensions				Basic load rating		Bearing number a) to d)	
	D	B ₂	C ₂	r _{s min} ¹⁾	r _{1s min} ¹⁾	dynamic kN	static kN	(TYPE A) With inner ring spacer
288.925	406.400	298.450	298.450	3.3	3.3	3 300	8 300	◎ E-M255449D/M255410/M255410DA
292.100	476.250	296.047	292.100	3.3	1.5	3 400	6 800	◎ E-EE921150D/921875/921876D
300	424	310	310	4	5	2 850	7 450	E-625960
	430	280	280	4	4	2 990	7 100	E-CRO-6019
	430	300	300	4	4	2 990	7 100	E-CRO-6022
	460	360	360	4	4	4 500	10 100	E-CRO-6015
	470	270	270	4	4	3 500	7 250	☆ E-CRO-6012
	470	292	292	4	4	3 900	8 300	☆ E-CRO-6013
	500	332	332	5	6	4 000	8 100	E-623160
300.038	422.275	311.150	311.150	3.3	3.3	3 700	9 600	◎ ☆ T-E-HM256849D/HM256810/HM256810DG2
304.648	438.048	279.400	279.400	3.3	3.3	2 740	6 500	◎ E-EE329119D/329172/329173D
	438.048	280.990	279.400	4.8	3.3	2 920	6 900	◎ E-M757448D/M757410/M757410D
304.800	419.100	269.875	269.875	6.4	1.5	2 650	6 850	◎ E-M257149D/M257110/M257110D
	444.500	247.650	241.300	1.5	8	2 050	4 600	◎ E-EE291202D/291750/291751D
	495.300	342.900	349.250	6.4	3.3	4 050	9 400	◎ E-EE724121D/724195/724196D
304.902	412.648	266.700	266.700	3.3	3.3	2 860	7 450	◎ E-M257248D/M257210/M257210D
305.003	438.048	280.990	279.400	4.8	3.3	2 920	6 900	◎ E-M757449D/M757410/M757410D
310	430	310	310	4	2.2	3 200	8 100	E-CRO-6213
	430	310	310	5.5	2.2	3 400	8 600	E-CRO-6204
317.500	422.275	269.875	269.875	3.3	1.5	2 510	7 050	◎ E-LM258649D/LM258610/LM258610D
	447.675	327.025	327.025	3.3	3.3	3 800	9 550	◎ T-E-HM259049D/HM259010/HM259010D
320	460	338	338	4	5	3 250	8 650	E-625964
327	445	230	230	4	2	2 380	5 650	E-CRO-6501
330	470	340	340	2.5	2.5	3 500	10 200	E-CRO-6604
	510	340	340	6	6	4 300	9 650	E-CRO-6602

1) Smallest allowable dimension for chamfer dimension r or r₁.

Four-Row Tapered Roller Bearings

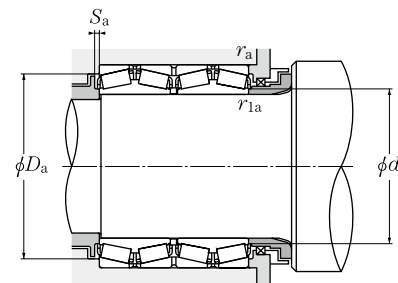

Dynamic equivalent radial load

$$P_r = X F_r + Y F_a$$

$\frac{F_a}{F_r} \leq e$		$\frac{F_a}{F_r} > e$	
X	Y	X	Y
1	Y ₁	0.67	Y ₂

Static equivalent radial load

$$P_{0r} = F_r + Y_0 F_a$$

For values of e, Y₁, Y₂ and Y₀ see the table below.

Bearing number a) to d)	Installation-related dimensions					Constant e	Axial load factors			Mass kg (approx.)
	d _a	D _a	mm S _a Min.	r _{as} Max.	r _{1as} Max.		Y ₁	Y ₂	Y ₀	
E-CRO-5815	311	376	5	3.3	3.3	0.34	2.00	2.98	1.96	125
	314	442	7	3.3	1.5	0.29	2.30	3.42	2.25	208
E-CRO-6033	329	389.5	7	3	4	0.33	2.03	3.02	1.98	138
	325.5	394.5	8	3	3	0.47	1.45	2.16	1.42	132
	323	393.5	3	3	3	0.47	1.45	2.16	1.42	141
	333.5	421.5	10	3	3	0.31	2.21	3.29	2.16	180
E-CRO-6033	348	432.5	7	3	3	0.37	1.80	2.69	1.76	152
	347	430	7	3	3	0.37	1.80	2.69	1.76	164
	346.5	449	5	4	4	0.40	1.68	2.50	1.64	257
	322	394	6	3.3	3.3	0.34	2.00	2.99	1.96	143
E-CRO-6148	327	410	8	3.3	3.3	0.33	2.04	3.04	2.00	143
	328	407	7	4.8	3.3	0.47	1.43	2.12	1.40	140
E-CRO-6148	330.5	387	5	6.4	1.5	0.33	2.03	3.02	1.98	115
	328	416	9.5	1.5	8	0.38	1.78	2.65	1.74	127
	334	450	3	6.4	3.3	0.40	1.68	2.50	1.64	273
E-CRO-6144	328.5	385.5	5	3.3	3.3	0.32	2.12	3.15	2.07	107
	328	407	7	4.8	3.3	0.47	1.43	2.12	1.40	139
E-CRO-6431	333	396.5	8.5	3	2	0.40	1.68	2.50	1.64	133
	333.5	397	7.5	4	2	0.33	2.03	3.02	1.98	136
E-CRO-6431	342.5	393.5	7	3.3	1.5	0.32	2.10	3.13	2.06	110
	340	418	5	3.3	3.3	0.33	2.02	3.00	1.97	161
	355	420.5	7	3	4	0.33	2.03	3.02	1.98	183
	353.5	416	5.5	3	2	0.33	2.03	3.02	1.98	99.8
E-CRO-6431	370	431.5	5.5	2	2	0.33	2.02	3.00	1.97	141
	368	462	5	5	5	0.40	1.68	2.50	1.64	221

a) Bearing numbers marked "◎" designate inch series bearings. b) When adopting bearings with bearing numbers marked with "☆", please consult NTN Engineering. c) Bearing numbers marked "☆" designate bearings with hollow rollers and pin type cages. d) Contact NTN Engineering for bearing numbers (TYPE B) without an inner ring spacer that are not listed.

Four-Row Tapered Roller Bearings

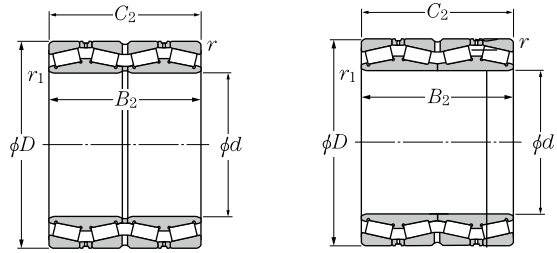

(TYPE A)
With inner ring spacer

(TYPE B)
Without inner ring spacer

d 330.200 ~ 380mm

d	Boundary dimensions				Basic load rating				Bearing number a) to d)
	mm				dynamic static kN				
	D	B ₂	C ₂	r _{s min} ¹⁾	r _{1s min} ¹⁾	C _r	C _{0r}	a) b) c)	(TYPE A) With inner ring spacer
330.200	482.600	306.388	311.150	3.3	1.5	3 100	7 900	◎	E-EE526131D/526190/526191D
	533.400	254	254	6	6	3 550	6 750		E-CRO-6606
333.375	469.900	342.900	342.900	3.3	3.3	4 400	11 000	◎	E-HM261049D/HM261010/HM261010DA
340	480	350	350	5	6	3 800	10 400		E-625968
	520	278	278	5	6	3 600	7 500		E-623068
341.312	457.098	254.000	254.000	3.3	1.5	2 630	6 900	◎	E-LM761648D/LM761610/LM761610D
342.900	533.400	307.985	301.625	3.3	3.3	3 500	6 900	◎	E-EE971355D/972100/972103D
343.052	457.098	254.000	254.000	3.3	1.5	2 640	6 900	◎	E-LM761649D/LM761610/LM761610D
	457.098	254.000	254.000	3.3	1.5	2 700	6 750		E-CRO-6910
346.075	488.950	358.775	358.775	3.3	3.3	4 850	12 800	◎ ☆	T-E-HM262749D/HM262710/HM262710DG2
347.662	469.900	292.100	292.100	3.3	3.3	3 550	9 100	◎	E-M262449D/M262410/M262410D
355.600	444.500	241.300	241.300	3.3	1.5	2 020	6 450	◎	T-E-L163149D/L163110/L163110D
	457.200	252.412	252.412	3.3	1.5	2 730	7 850	◎	E-LM263149D/LM263110/LM263110D
	482.600	265.112	269.875	3.3	1.5	3 100	7 650	◎	E-LM763449D/LM763410/LM763410D
	488.950	317.500	317.500	3.3	1.5	3 850	10 000	◎	E-M263349D/M263310/M263310D
360	508	370	370	5	6	4 100	11 200		E-625972
	520	370	370	5.5	3.5	4 950	12 300		E-CRO-7220
	520	410	410	5	5	5 700	14 700	☆	E-CRO-7217
	540	340	340	5	3	4 850	11 100		E-CRO-7211
	600	396	396	5	6	6 100	13 000		E-623172
368.300	523.875	382.588	382.588	6.4	3.3	4 950	13 100	◎ ☆	E-HM265049D/HM265010/HM265010DG2
	596.900	342.900	342.900	6.4	6.4	4 750	10 600	◎	E-EE181455D/182350/182351D
374.650	501.650	250.825	260.350	3.3	1.5	3 000	6 250	◎	E-LM765149D/LM765110/LM765110D
380	536	390	390	5	6	5 450	14 100		E-625976
	560	282	282	5	6	3 950	8 700		E-623076
	560	285	285	5	5	3 600	7 700		E-CRO-7612

1) Smallest allowable dimension for chamfer dimension r or r₁.

Four-Row Tapered Roller Bearings

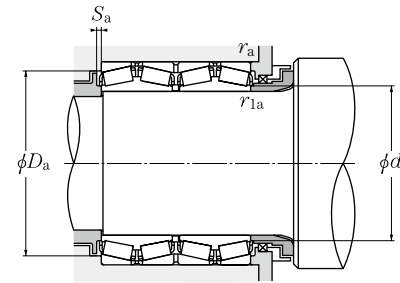

Dynamic equivalent radial load

$$P_r = X F_r + Y F_a$$

$\frac{F_a}{F_r} \leq e$		$\frac{F_a}{F_r} > e$	
X	Y	X	Y
1	Y ₁	0.67	Y ₂

Static equivalent radial load

$$P_{0r} = F_r + Y_0 F_a$$

For values of e, Y₁, Y₂ and Y₀ see the table below.

Bearing number a) to d)	Installation-related dimensions					Constant e	Axial load factors			Mass kg (approx.)
	d _a	D _a	mm S _a Min.	r _{as} Max.	r _{las} Max.		Y ₁	Y ₂	Y ₀	
(TYPE B) Without inner ring spacer	351	449	3	3.3	1.5	0.39	1.72	2.56	1.68	197
	378.5	488	6.5	5	5	0.37	1.80	2.69	1.76	221
E-CRO-6711	356.5	434	5	3.3	3.3	0.33	2.02	3.00	1.97	187
	373	440.5	7	4	5	0.33	2.03	3.02	1.98	200
	382.5	478	6.5	4	4	0.37	1.80	2.69	1.76	213
	359	432	5	3.3	1.5	0.47	1.43	2.12	1.40	125
	370	501	11	3.3	3.3	0.33	2.03	3.02	1.98	252
E-CRO-6945	367	424.5	5	3.3	1.5	0.47	1.43	2.12	1.40	117
E-CRO-6944	361	426	5	3.3	1.5	0.47	1.43	2.12	1.40	105
	368	456	6	3.3	3.3	0.33	2.02	3.00	1.97	227
	365	444	8	3.3	3.3	0.33	2.03	3.02	1.98	148
E-CRO-7123	370	422	6.5	3.3	1.5	0.31	2.20	3.27	2.15	89.5
	372	434	6	3.3	1.5	0.32	2.12	3.15	2.07	106
	379.5	449	3	3.3	1.5	0.47	1.43	2.14	1.40	145
	374	459	5	3.3	1.5	0.33	2.03	3.02	1.98	173
E-CRO-7227	394	466.5	7	4	5	0.33	2.03	3.02	1.98	236
	391.5	478	5	4.5	3	0.33	2.03	3.02	1.98	260
	396	478	8.5	4	4	0.33	2.03	3.02	1.98	297
E-CRO-7228	400	496	5	4	2.5	0.33	2.03	3.02	1.98	270
	416.5	541.5	8	4	5	0.40	1.68	2.50	1.64	447
E-CRO-7406	408	481.5	6	6.4	3.3	0.33	2.03	3.02	1.98	280
	421	552	7.5	6.4	6.4	0.42	1.62	2.42	1.59	373
	393	472	2	3.3	1.5	0.47	1.43	2.12	1.40	145
	410	494	8	4	5	0.33	2.03	3.02	1.98	277
	421	518.5	6.5	4	4	0.37	1.80	2.69	1.76	240
	420	517	7	4	4	0.40	1.68	2.50	1.64	208

a) Bearing numbers marked "◎" designate inch series bearings. b) When adopting bearings with bearing numbers marked with "☆", please consult NTN Engineering. c) Bearing numbers marked "☆" designate bearings with hollow rollers and pin type cages. d) Contact NTN Engineering for bearing numbers (TYPE B) without an inner ring spacer that are not listed.

Four-Row Tapered Roller Bearings

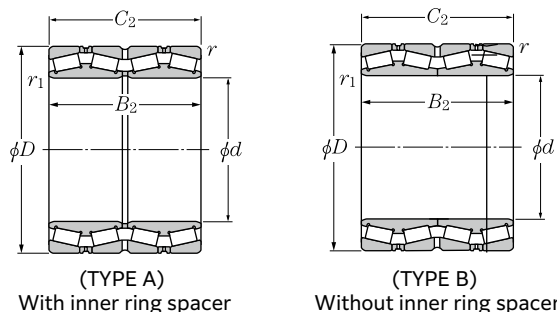

Four-Row Tapered Roller Bearings

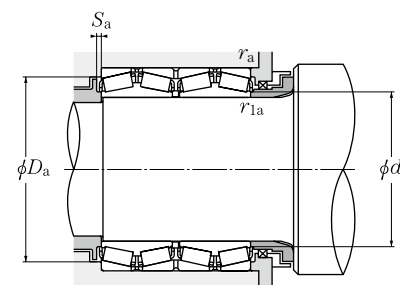

Dynamic equivalent radial load

$$P_r = X F_r + Y F_a$$

$\frac{F_a}{F_r} \leq e$		$\frac{F_a}{F_r} > e$	
X	Y	X	Y
1	Y ₁	0.67	Y ₂

Static equivalent radial load

$$P_{0r} = F_r + Y_0 F_a$$

For values of e , Y_1 , Y_2 and Y_0 see the table below.

d 380 ~ 447.675mm

d	Boundary dimensions				Basic load rating				Bearing number a) to d)
	D	B ₂	C ₂	r _{s min} ¹⁾ / r _{1s min} ¹⁾	dynamic	static	C _r	C _{0r}	
380	560	360	360	6	1.5	5 150	12 100		E-CRO-7622
	560	360	360	5	1.5	5 600	13 500	☆	E-CRO-7621
384.175	546.100	400.050	400.050	6.4	3.3	6 000	16 100	◎ ☆	T-E-HM266449D/HM266410/HM266410DG2
385.762	514.350	317.500	317.500	3.3	3.3	4 000	11 100	◎	E-LM665949D/LM665910/LM665910D
390	510	350	350	3.5	1.5	4 100	11 800		E-CRO-7801
393.700	546.100	288.925	288.925	6.4	1.5	3 550	10 200	◎	E-LM767745D/LM767710/LM767710D
400	564	412	412	5	6	5 400	14 700		E-625980
	635	470	470	5	2.5	8 000	18 000		E-CRO-8010
406.400	546.100	268.288	288.925	6.4	1.5	2 740	7 000	◎	T-E-EE234161D/234215/234216D
	546.100	288.925	288.925	6.4	1.5	3 550	10 200	◎	E-LM767749D/LM767710/LM767710D
	565.150	381.000	381.000	6.4	3.3	5 300	14 100		E-CRO-8103
	590.550	400.050	400.050	6.4	3.3	5 350	13 600	◎	E-EE833161D/833232/833233D
	609.600	309.562	317.500	6.4	3.5	4 100	9 600	◎	E-EE911603D/912400/912401D
409.575	546.100	334.962	334.962	6.4	1.5	4 400	12 700	◎ ☆	E-M667947D/M667911/M667911DG2
415.925	590.550	434.975	434.975	6.4	3.3	6 950	18 900	◎ ☆	T-E-M268749D/M268710/M268710DG2
420	592	432	432	5	6	5 950	16 300		E-625984
431.800	571.500	279.400	279.400	3.3	1.5	3 550	9 850	◎	T-E-LM869449D/LM869410/LM869410D
	571.500	336.550	336.550	6.4	1.5	4 100	11 800	◎	E-LM769349D/LM769310/LM769310D
	635.000	355.600	355.600	6.4	6.4	6 300	15 000	◎ ☆	E-EE931170D/931250/931251XDG2
432.003	609.524	317.500	317.500	6.4	3.5	4 850	11 500	◎	E-EE736173D/736238/736239D
440	620	454	454	6	6	7 200	19 900		E-625988
	635	470	470	6.4	3.3	7 900	22 100	☆	E-CRO-8808
	650	355	355	7.5	4	5 950	13 400	☆	E-CRO-8807
447.675	635.000	463.550	463.550	6.4	3.3	7 900	22 100	◎ ☆	E-M270749D/M270710/M270710DG2

1) Smallest allowable dimension for chamfer dimension r or r_1 .

Bearing number a) to d)	Installation-related dimensions					Constant	Axial load factors			Mass
	d _a	D _a	mm S _a Min.	r _{as} Max.	r _{las} Max.		e	Y ₁	Y ₂	
(TYPE B) Without inner ring spacer	416.5	514	7	5	1.5	0.40	1.68	2.50	1.64	302
	423	514.5	6.5	4	1.5	0.40	1.68	2.50	1.64	312
	411	507	6.5	6.4	3.3	0.33	2.03	3.02	1.98	312
	409	482	7	3.3	3.3	0.42	1.61	2.40	1.58	240
	411.5	478	7	3	1.5	0.33	2.03	3.02	1.98	186
	418	510	6.5	6.4	1.5	0.48	1.42	2.11	1.38	219
	434	518	7	4	5	0.33	2.03	3.02	1.98	324
	447	579.5	6.5	4	2	0.33	2.03	3.02	1.98	564
	425	504	1.5	6.4	1.5	0.48	1.42	2.11	1.39	190
	427	510	6.5	6.4	1.5	0.48	1.42	2.11	1.38	201
	441	524.5	6.5	6.4	3.3	0.35	1.95	2.90	1.91	310
	435	549	6.5	6.4	3.3	0.33	2.07	3.09	2.03	395
	437	567	1.5	6.4	3.5	0.38	1.76	2.62	1.72	332
	431	510	5.5	6.4	1.5	0.42	1.61	2.40	1.58	226
	444	548.9	9	6.4	3.3	0.33	2.03	3.02	1.98	421
E-CRO-8414	457	545	7	4	5	0.33	2.03	3.02	1.98	374
	453	537	8	3.3	1.5	0.55	1.24	1.84	1.21	193
	453	534	6.5	6.4	1.5	0.44	1.52	2.26	1.49	232
	468.1	591.1	6.6	6.4	6.4	0.32	2.12	3.15	2.07	402
	459	570	6.5	6.4	3.5	0.35	1.95	2.90	1.91	297
E-CRO-8839	479	572.5	8	5	5	0.33	2.03	3.02	1.98	430
	494	585	9	6.4	3.3	0.33	2.03	3.02	1.98	498
	498	601	9	6	3	0.33	2.03	3.02	1.98	400
	478	591	8	6.4	3.3	0.33	2.03	3.02	1.98	509

a) Bearing numbers marked "◎" designate inch series bearings. b) When adopting bearings with bearing numbers marked with "☆", please consult NTN Engineering. c) Bearing numbers marked "☆" designate bearings with hollow rollers and pin type cages. d) Contact NTN Engineering for bearing numbers (TYPE B) without an inner ring spacer that are not listed.

Four-Row Tapered Roller Bearings

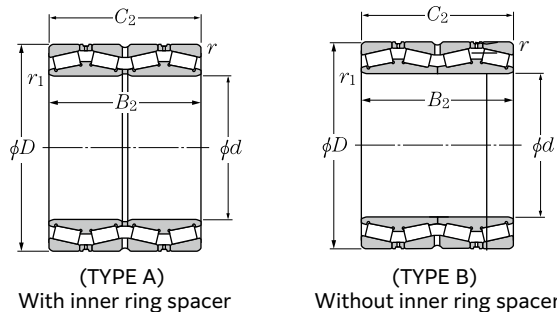

Four-Row Tapered Roller Bearings

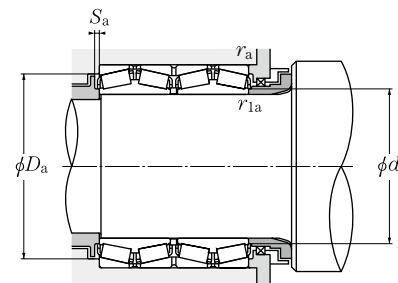

Dynamic equivalent radial load

$$P_r = X F_r + Y F_a$$

$\frac{F_a}{F_r} \leq e$		$\frac{F_a}{F_r} > e$	
X	Y	X	Y
1	Y ₁	0.67	Y ₂

Static equivalent radial load

$$P_{0r} = F_r + Y_0 F_a$$

For values of e , Y_1 , Y_2 and Y_0 see the table below.

d 457.200 ~ 555.625mm

d	Boundary dimensions				Basic load rating				Bearing number a) to d)
	mm				dynamic static				
	D	B ₂	C ₂	r _{s min} ¹⁾	r _{1s min} ¹⁾	C _r	C _{0r}	a) b) c)	(TYPE A) With inner ring spacer
457.200	596.900	276.225	279.400	3.3	1.5	3 200	9 150	◎	E-L770849D/L770810/L770810D
	596.900	276.225	276.225	3.3	1.6	3 200	9 400	◎	E-EE244181D/244235/244236D
	660.400	323.850	323.847	6.4	3.3	4 600	11 200	◎	E-EE737179D/737260/737260D
460	650	474	474	6	6	7 200	19 900		E-625992A
475	660	450	450	5	3	7 250	20 400		E-CRO-9501
480	678	494	494	6	6	6 950	19 600		E-625996
	678	494	494	6	6	6 950	19 600		E-CRO-9612
482.600	615.950	330.200	330.200	6.4	3.3	4 400	13 400	◎ ☆	E-LM272249D/LM272210/LM272210DG2
488.950	660.400	365.125	361.950	6.4	8	5 950	16 100	◎ ☆	T-E-EE640193D/640260/640261DG2
489.026	634.873	320.675	320.675	3.3	3.3	4 750	12 000	◎	E-LM772749D/LM772710/LM772710DA
500	670	515	515	5	1.5	7 450	24 600		E-CRO-10008
	705	515	515	6	6	9 350	27 100	☆	E-6259/500
	730	420	420	6	6	8 250	19 900	☆	E-CRO-10023
501.650	711.200	520.700	520.700	6.4	3.3	9 600	27 300	◎ ☆	E-M274149D/M274110/M274110DG2
508.000	762.000	463.550	463.550	6.4	6.4	8 600	21 400	◎ ☆	E-EE531201D/531300/531301XDG2
509.948	654.924	377.000	379.000	6.4	1.5	5 650	17 600	☆	E-CRO-10208
514.350	673.100	422.275	422.275	6.4	3.3	6 600	20 500	◎	E-LM274449D/LM274410/LM274410D
519.112	736.600	536.575	536.575	6.4	3.3	10 100	28 700	◎ ☆	E-M275349D/M275310/M275310DG2
520	735	535	535	5	7	10 100	28 700	☆	E-CRO-10402
533.400	965.200	495.300	495.300	7.5	7.5	12 300	28 700	☆	E-CRO-10702
536.575	761.873	558.800	558.800	6.4	3.3	11 200	30 500	◎ ☆	E-M276449D/M276410/M276410DG2
555.625	698.500	349.250	349.250	6.4	3.2	4 850	14 300		E-CRO-11101

1) Smallest allowable dimension for chamfer dimension r or r_1 .

Bearing number a) to d)	Installation-related dimensions					Constant	Axial load factors			Mass
	d _a	D _a	mm S _a Min.	r _{as} Max.	r _{1as} Max.		e	Y ₁	Y ₂	
(TYPE B) Without inner ring spacer	478	567	5.5	3.3	1.5	0.47	1.43	2.12	1.40	201
	478	567	5.5	3.3	1.6	0.40	1.67	2.49	1.63	207
	489	614.9	6.5	6.4	3.3	0.37	1.80	2.69	1.76	379
E-CRO-9508	499	598.5	7	5	5	0.33	2.03	3.02	1.98	493
	510.5	611.5	10	4	2.5	0.34	1.98	2.94	1.93	465
	525.5	623	7	5	5	0.33	2.03	3.02	1.98	563
E-CRO-10214	525	622.5	2	5	5	0.33	2.03	3.02	1.98	554
	504	585	6.5	6.4	3.3	0.33	2.03	3.02	1.98	250
	516	624	9	6.4	8	0.31	2.20	3.27	2.15	364
E-CRO-10408	516	600	6.5	3.3	3.3	0.47	1.43	2.12	1.40	268
	526.5	619	8	4	1.5	0.40	1.68	2.50	1.64	598
	553	649.5	7.5	5	5	0.33	2.03	3.02	1.98	632
E-CRO-11103	554	675	7.5	5	5	0.40	1.68	2.50	1.64	606
	534	663	9.5	6.4	3.3	0.33	2.03	3.02	1.98	726
	550.7	710.9	9.5	6.4	6.4	0.38	1.77	2.64	1.73	740
E-CRO-10214	540	611.5	5	6.4	1.5	0.41	1.65	2.46	1.61	320
	540	636	8	6.4	3.3	0.33	2.03	3.02	1.98	390
	569	677	9.5	6.4	3.3	0.33	2.03	3.02	1.98	761
E-CRO-10408	569	676.5	11	4	6	0.33	2.03	3.02	1.98	750
	680	854.5	7.5	6	6	0.32	2.12	3.15	2.07	1 662
	564	711	9.5	6.4	3.3	0.33	2.03	3.02	1.98	890
E-CRO-11103	581	659	6.5	6.4	3.3	0.33	2.03	3.02	1.98	298

a) Bearing numbers marked "◎" designate inch series bearings. b) When adopting bearings with bearing numbers marked with "*", please consult NTN Engineering. c) Bearing numbers marked "☆" designate bearings with hollow rollers and pin type cages. d) Contact NTN Engineering for bearing numbers (TYPE B) without an inner ring spacer that are not listed.

Four-Row Tapered Roller Bearings

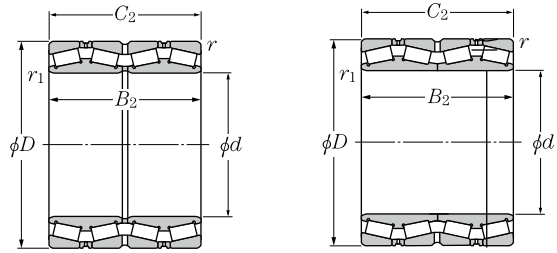

(TYPE A)
With inner ring spacer

(TYPE B)
Without inner ring spacer

d 558.800 ~ 749.300mm

d	Boundary dimensions				Basic load rating				Bearing number a) to d)
	mm				dynamic static				
	D	B ₂	C ₂	r _{s min} ¹⁾	r _{1s min} ¹⁾	C _r	C _{0r}	a) b) c)	(TYPE A) With inner ring spacer
558.800	736.600	322.265	322.268	6.4	3.3	4 750	13 500	◎	E-EE843221D/843290/843291D
	736.600	409.575	409.575	6.4	3.3	6 750	20 500	◎ ☆	E-LM377449D/LM377410/LM377410DG2
570	780	515	515	6	6	10 200	31 000	☆	E-CRO-11402
571.500	812.800	593.725	593.725	6.4	3.3	13 200	36 500	◎ ☆	E-M278749D/M278710/M278710DG2
584.200	762.000	396.875	401.638	6.4	3.3	7 300	22 300	◎ ☆	E-LM778549D/LM778510/LM778510DG2
585.788	771.525	479.425	479.425	6.4	3.3	8 150	25 700	☆	E-CRO-11701
595.312	844.550	615.950	615.950	6.4	3.3	13 600	39 000	☆	E-CRO-11913
	844.550	615.950	615.950	6.4	3.3	14 000	40 500	◎ ☆	E-M280049D/M280010/M280010DG2
609.600	787.400	361.950	361.950	6.4	3.3	7 150	20 300	◎ ☆	E-EE649241D/649310/649311DG2
	863.600	660.400	660.400	6.4	3.3	15 000	42 000	◎ ☆	E-M280349D/M280310/M280310DG2
611.500	832.800	593.725	593.725	6.4	3.3	12 700	37 500	☆	E-CRO-12202
630	920	600	600	7.5	7.8	14 600	39 000	☆	E-CRO-12604
650	1 030	560	560	7.5	12	15 000	35 000	☆	E-CRO-13001
660	1 070	642	642	7.5	7.5	17 000	43 500	☆	E-CRO-13202
660.400	812.800	365.125	365.125	6.4	3.3	6 900	23 200	◎ ☆	E-L281149D/L281110/L281110DG2
670	960	700	700	7.5	7.5	18 500	51 500	☆	E-CRO-13401
	1 090	710	710	7.5	7.5	21 200	50 000	☆	E-CRO-13404
	1 090	710	710	7.5	7.5	19 300	47 500	☆	E-CRO-13402
685.800	876.300	352.425	355.600	6.4	3.3	6 700	21 800	◎ ☆	E-EE655271D/655345/655346DG2
711.200	914.400	317.500	317.500	6.4	16	5 900	17 900	◎ ☆	E-EE755280D/755360/755361DG2
730.250	1 035.050	755.650	755.650	6.4	3.3	20 100	59 500	◎ ☆	E-M283449D/M283410/M283410DG2
749.300	990.600	605.000	605.000	6.4	3.3	14 000	45 500	◎ ☆	E-LM283649D/LM283610/LM283610DG2

1) Smallest allowable dimension for chamfer dimension r or r₁.

Four-Row Tapered Roller Bearings

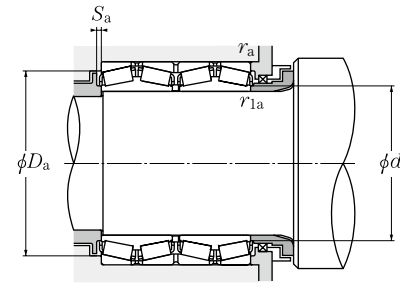

Dynamic equivalent radial load

$$P_r = X F_r + Y F_a$$

$\frac{F_a}{F_r} \leq e$		$\frac{F_a}{F_r} > e$	
X	Y	X	Y
1	Y ₁	0.67	Y ₂

Static equivalent radial load

$$P_{0r} = F_r + Y_0 F_a$$

For values of e, Y₁, Y₂ and Y₀ see the table below.

Bearing number a) to d)	Installation-related dimensions					Constant e	Axial load factors			Mass kg (approx.)
	d _a	D _a	mm S _a Min.	r _{as} Max.	r _{1as} Max.		Y ₁	Y ₂	Y ₀	
E-CRO-11216	585	699	8.5	6.4	3.3	0.34	1.98	2.94	1.93	388
	602	688	8	6.4	3.3	0.35	1.95	2.90	1.91	502
	622	723	7.5	5	5	0.33	2.03	3.02	1.98	625
	609	756	11	6.4	3.3	0.33	2.03	3.02	1.98	1 080
	615	717	7	6.4	3.3	0.47	1.43	2.14	1.40	511
	628	717.5	9.5	6.4	3.3	0.35	1.95	2.90	1.91	610
	654	781	7	6.4	3.3	0.33	2.03	3.02	1.98	1 135
	633	786	11	6.4	3.3	0.33	2.03	3.02	1.98	1 160
	636	747	9.5	6.4	3.3	0.33	2.03	3.02	1.98	458
	648	807	13.5	6.4	3.3	0.33	2.03	3.02	1.98	1 250
	660	776	11.5	6.4	3.3	0.33	2.03	3.02	1.98	960
	702	848.5	7.5	6	6	0.33	2.03	3.02	1.98	1 390
	765	947.5	8.5	6	10	0.32	2.12	3.15	2.07	1 760
	778	964	9	6	6	0.32	2.12	3.15	2.07	1 950
E-CRO-13211	695	770.5	9	6.4	3.3	0.37	1.80	2.69	1.76	448
	740	888.5	8	6	6	0.33	2.03	3.02	1.98	1 600
	782	996.5	13.5	6	6	0.29	2.32	3.45	2.26	2 690
	799	995.5	13.5	6	6	0.32	2.12	3.15	2.07	2 600
E-CRO-13708	738	824	8	6.4	3.3	0.42	1.61	2.40	1.58	539
	762	873	8	6.4	16	0.38	1.77	2.64	1.73	527
E-CRO-14601	804	961	13	6.4	3.3	0.33	2.03	3.02	1.98	2 210
	786	936	10.5	6.4	3.3	0.33	2.03	3.02	1.98	1 250

a) Bearing numbers marked "◎" designate inch series bearings. b) When adopting bearings with bearing numbers marked with "*", please consult NTN Engineering. c) Bearing numbers marked "☆" designate bearings with hollow rollers and pin type cages. d) Contact NTN Engineering for bearing numbers (TYPE B) without an inner ring spacer that are not listed.

Special Application Bearings

Special Application Bearings

Four-Row Tapered Roller Bearings

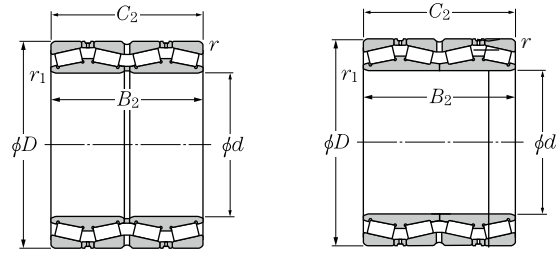

(TYPE A)
With inner ring spacer

(TYPE B)
Without inner ring spacer

d 762 ~ 938.212mm

d	Boundary dimensions				Basic load rating				Bearing number a) to d)
	D	B ₂	C ₂	r _{s min} ¹⁾ / r _{1s min} ¹⁾	dynamic	static	C _r	C _{0r}	
762.000	1 066.800	723.900	736.600	12.7	4.3	19 500	58 500	◎ ☆	E-M284148D/M284111/M284210DG2
	1 079.500	787.400	787.400	12.7	4.8	21 100	65 000	◎ ☆	E-M284249D/M284210/M284210DG2
825.500	1 168.400	844.550	844.550	12.7	4.8	24 700	76 500	◎ ☆	E-M285848D/M285810/M285810DG2
840	1 170	840	840	6	6	24 300	76 500	☆	E-CRO-16803
863.600	1 130.300	669.925	669.925	12.7	4.8	17 500	59 500	◎ ☆	E-LM286249D/LM286210/LM286210DG2
	1 219.200	876.300	889.000	12.7	4.8	26 700	83 000	◎ ☆	E-EE547341D/547480/547481DG2
938.212	1 270.000	825.500	825.500	12.7	4.8	25 000	80 000	◎ ☆	E-LM287649D/LM287610/LM287610DG2

Four-Row Tapered Roller Bearings

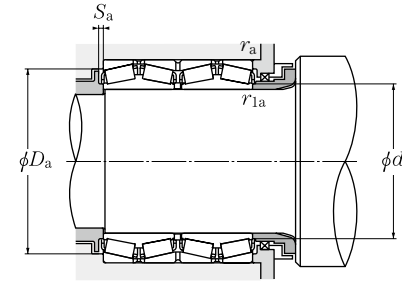

Dynamic equivalent radial load
 $P_r = XF_r + YF_a$

$\frac{F_a}{F_r} \leq e$		$\frac{F_a}{F_r} > e$	
X	Y	X	Y
1	Y ₁	0.67	Y ₂

Static equivalent radial load
 $P_{0r} = F_r + Y_0 F_a$

For values of e, Y₁, Y₂ and Y₀ see the table below.

Bearing number a) to d)	Installation-related dimensions					Constant e	Axial load factors			Mass kg (approx.)
	d _a	D _a	mm S _a Min.	r _{as} Max.	r _{1as} Max.		Y ₁	Y ₂	Y ₀	
(TYPE B) Without inner ring spacer										
	819	978	3.5	12.7	4.3	0.33	2.03	3.02	1.98	2 220
	810	1 005	13	12.7	4.8	0.33	2.03	3.02	1.98	2 480
	879	1 085	13	12.7	4.8	0.33	2.03	3.02	1.98	3 010
	918	1 081	12	5	5	0.33	2.03	3.02	1.98	3 970
E-CRO-17302	928	1 056	11	12.7	4.8	0.33	2.03	3.02	1.98	1 950
E-CRO-17301	946	1 123.5	6.5	12.7	4.8	0.33	2.03	3.02	1.98	3 640
E-CRO-18802	1 015	1 183	10	12.7	4.8	0.33	2.03	3.02	1.98	4 100

1) Smallest allowable dimension for chamfer dimension r or r₁.

a) Bearing numbers marked "◎" designate inch series bearings. b) When adopting bearings with bearing numbers marked with "*", please consult NTN Engineering. c) Bearing numbers marked "☆" designate bearings with hollow rollers and pin type cages. d) Contact NTN Engineering for bearing numbers (TYPE B) without an inner ring spacer that are not listed.



The **NTN** ultra-thin section type ball bearings are bearings with an extremely thin design. There are three ultra-thin ball bearing types: radial, four-point contact, and angular. Bearing seals are available for all types.

Each bearing type has different characteristics to best support a wide range of applications.

1. Types and features

Table 1 shows the types and features of ultra-thin section type ball bearings, corresponding dimension series code, bearing cross section dimension, and inner diameter dimension range.

The dimension table (from C-62 to C-65) shows dimension series codes S and A, and H and J for bearings with seal.

Table 1 Types and features

	Types			Dimension series code	Bearing cross section dimension mm	Inner diameter dimension range mm
	Radial type	4-point contact type	Angular type			
					$\frac{D-d}{2} \times B$	d
Features	A deep groove is present in both the inner and outer rings of the bearing, allowing them to support radial and axial loads in either direction as well as the complex loads which result from the combination of these forces. Deep groove ball bearings are used in the most applications.	When inner and outer rings are loaded in the radial direction, the ball comes into contact with the inner and outer rings at four points. The bearings are generally suitable for two contact points under a simple axial load or a complex load with a large axial load.	Angular contact ball bearings have a straight line that runs through the point where each ball contacts the inner and outer rings at two points at 30° with respect to the radial direction. The bearings can receive a unidirectional axial load or a complex load of radial load and axial load. The ability to include an increased number of balls increases the load capacity of the bearing. These bearings are normally used in pairs for applications where it is necessary to control the axial movement via axial internal clearance or preload.	S	4.762 × 4.762	25.4 ~ 38.1
				A	6.35 × 6.35	50.8 ~ 304.8
				B	7.938 × 7.938	50.8 ~ 508
				C	9.525 × 9.525	101.6 ~ 762
				D	12.7 × 12.7	101.6 ~ 762
				F	19.05 × 19.05	101.6 ~ 1016
				G	25.4 × 25.4	101.6 ~ 1016
				With seal		
J	9.525 × 12.7	101.6 ~ 304.8				

2. Part number

K X A 050

- K**: Bore diameter No. The bearing bore diameter is represented in inches. 050 → 5 inch 042 → 4.25 inch
- X**: Dimension series code (see **Table 1**)
- A**: Type code
Code Type
R → Radial type
X → 4-point contact type
Y → Angular type
- 050**: Ultra-thin section type ball bearing

3. Accuracy and radial internal clearance

Tables 2 and **3** show the accuracy and radial internal clearance of ultra-thin section type ball bearings.

Table 2 Accuracy and radial internal clearance of radial type ball bearings

Bearing bore diameter No.	Tolerance and tolerance values						Radial internal clearance	
	Mean bore diameter deviation Δd_{mp}	Mean outside diameter deviation ΔD_{mp}	Dimensional tolerance of inner ring and outer ring widths $\Delta B_s \Delta C_s$	Radial runout (Max.) Axial runout		Radial internal clearance		
				Inner ring $K_{ia} S_{ia}$	Outer ring $K_{ea} S_{ea}$			
010	0	0	0	13	20	25~ 41		
015	0	0		15	20	30~ 46		
020	0	-13		20	25	30~ 61		
025	0	-15						
030	0	0		25	30	41~ 71		
035	0	-15						
040	0	-20						
042	0	0		36	41	51~ 86		
045	0	-20						
047	0	0		0	41	61~107		
050	0	-25						
055	0	-25						
060	0	-25						
065	0	0	46				71~122	81~132
070	0	-30						
075	0	-30						
080	0	-30						
090	0	-36	51				91~142	102~152
100	0	-36						
110	0	-46	51	152~203	203~254			
120	0	-76						
140	0	-102						
160	0	-102						
180	0	-102						
200	0	-102						
250	0	-102						
300	0	-102						
350	0	-102						
400	0	-102						

Table 3 Accuracy and radial internal clearance of four-point contact ball bearings/angular type ball bearings

Bearing bore diameter No.	Tolerance and tolerance values						Radial internal clearance (4-point contact type)	
	Mean bore diameter deviation Δd_{mp}	Mean outside diameter deviation ΔD_{mp}	Dimensional tolerance of inner ring and outer ring widths $\Delta B_s \Delta C_s$	Radial runout (Max.) Axial runout		Radial internal clearance (4-point contact type)		
				Inner ring $K_{ia} S_{ia}$	Outer ring $K_{ea} S_{ea}$			
010	0	0	0	7.5	10	25~ 38		
015	0	0		10	10	30~ 43		
020	0	-13		13	13	30~ 56		
025	0	-15						
030	0	0		15	15	41~ 66		
035	0	-15						
040	0	-20						
042	0	0		20	20	51~ 76		
045	0	-20						
047	0	0		0	25	25		
050	0	-25						
055	0	-25						
060	0	-25						
065	0	0	30				30	61~ 86
070	0	-30						
075	0	-30						
080	0	-30						
090	0	-36	36				36	71~ 97
100	0	-36						
110	0	-46	41	41	81~107			
120	0	-76						
140	0	-102						
160	0	-102						
180	0	-102						
200	0	-102						
250	0	-102						
300	0	-102						
350	0	-102						
400	0	-102						

4. Dimensional tolerance of shaft and housing bores

Table 4 shows the recommended tolerance of shaft and housing bores when using ultra-thin section type ball bearings.

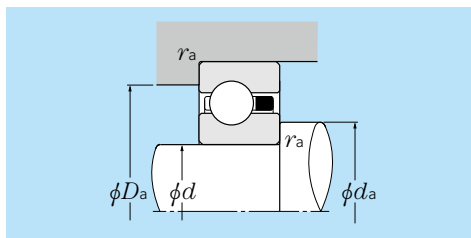

Table 4 Dimensional tolerance of shafts and housings unit: μm

Bearing bore diameter No.	For radial type ball bearings				For four-point contact type/ angular type ball bearings			
	Inner ring rotation		Outer ring rotation		Inner ring rotation		Outer ring rotation	
	Shaft	Housing	Shaft	Housing	Shaft	Housing	Shaft	Housing
010	+10 0	+13	-10 -20	-13	+10 0	+13	-10 -20	-13
015	+13 0	0	-13 -25	-25	+13 0	+13	-13 -25	-13
020						0		-25
025	+15 0	+15 0	-15 -30	-15 -30	+15 0		-15 -30	
030						+15 0		-15 -30
035								-15 -30
040	+20 0		-20 -40		+20 0		-20 -40	
042								
045		+20 0		-20 -40		+20 0		-20 -40
047								
050								
055	+25 0	+25 0	-25 -50	-25 -50	+25 0	+25 0	-25 -50	-25 -50
060								
065								
070								
075	+30 0	+30 0	-30 -60	-30 -60	+30 0	+30 0	-30 -60	-30 -60
080								
090								
100								
110	+35 0	+35 0	-35 -70	-35 -70	+35 0	+35 0	-35 -70	-35 -70
120								
140	+40 0	+40 0	-40 -80	-40 -80				
160	+45 0	+45 0	-45 -90	-45 -90	+40 0	+40 0	-40 -80	-40 -80
180								
200	+50 0	+50 0	-50 -100	-50 -100	+45 0	+45 0	-45 -90	-45 -90
250	+75 0	+75 0	-75 -150	-75 -150				
300								
350	+100 0	+100 0	-100 -200	-100 -200	+100 0	+100 0	-50 -100	-50 -100
400								

5. Installation-related dimensions of shafts and housings

Table 5 shows the installation-related dimensions of shafts and housings when using ultra-thin section type ball bearings.

Table 5 Installation-related dimensions of shafts and housings unit: mm

Dimension series code	$d_a \quad d+f$ (Max.) $d+e$ (Min.)		$D_a \quad d+h$ (Max.) $d+g$ (Min.)		r_{as} (Max.)
	e	f	g	h	
S	3.4	5.3	4.2	6.1	0.2
A	4.6	7.3	5.4	8.2	0.4
B	5.7	9.3	6.6	10.2	0.8
C	6.9	11.3	7.7	12.2	0.8
D	9.2	15.3	10.1	16.2	1.3
F	13.9	23.3	14.8	24.2	1.8
G	18.7	31.3	19.5	32.1	1.8
J,H ¹⁾	6.9	11.3	7.7	12.2	0.2

1) Bearings with seal

Ultra-Thin Section Type Ball Bearings



S series
A series

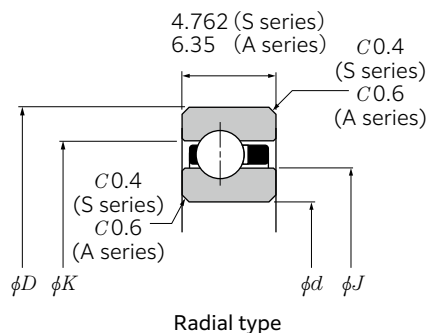

Radial type

Ultra-Thin Section Type Ball Bearings

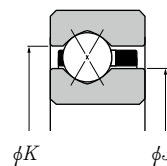

4-point contact type

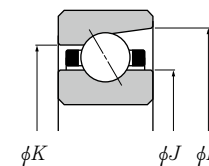

Angular type

d 25.4 ~ 304.8mm

Boundary dimensions		Radial type			4-point contact type					Angular type							
mm		dynamic	static	Fatigue load limit	Basic load rating		Basic load rating			Basic load rating		Basic load rating					
d	D	kN			Radial		Radial		Axial	Radial		Radial		Fatigue load limit			
		C_r	C_{0r}	C_u	C_r	C_{0r}	C_a	C_{0a}	C_u	C_r	C_{0r}	C_a	C_{0a}	C_u			
25.4	34.925	2.75	1.94	0.084	2.40	1.66	3.15	5.05	0.181	2.91	2.21	3.80	6.70	0.147			
38.1	47.625	3.10	2.60	0.112	2.71	2.23	3.55	6.75	0.243	3.35	3.10	4.40	9.35	0.205			
50.8	63.5	5.00	4.30	0.186	4.35	3.70	5.70	11.2	0.400	5.25	4.95	6.90	14.9	0.325			
63.5	76.2	5.40	5.20	0.224	4.70	4.45	6.15	13.5	0.485	5.65	5.95	7.45	18.1	0.395			
76.2	88.9	5.75	6.10	0.263	5.00	5.25	6.55	15.9	0.570	6.05	7.00	7.95	21.2	0.465			
88.9	101.6	6.05	7.00	0.300	5.25	6.00	6.90	18.2	0.655	6.35	8.00	8.35	24.3	0.530			
101.6	114.3	6.35	7.85	0.325	5.50	6.80	7.25	20.6	0.710	6.65	9.05	8.75	27.4	0.580			
107.95	120.65	6.50	8.30	0.335	5.60	7.15	7.40	21.7	0.730	6.80	9.55	8.95	29.0	0.595			
114.3	127	6.60	8.75	0.345	5.75	7.55	7.55	22.9	0.750	6.95	10.1	9.15	30.5	0.610			
120.65	133.35	6.75	9.20	0.350	5.85	7.95	7.70	24.1	0.765	7.10	10.6	9.30	32.0	0.625			
127	139.7	6.85	9.65	0.360	5.95	8.35	7.85	25.2	0.785	7.20	11.1	9.50	33.5	0.640			
139.7	152.4	7.10	10.5	0.375	6.15	9.10	8.10	27.6	0.820	7.45	12.1	9.80	37.0	0.665			
152.4	165.1	7.35	11.4	0.390	6.35	9.85	8.35	29.9	0.855	7.70	13.2	10.1	40.0	0.695			
165.1	177.8	7.55	12.3	0.405	6.55	10.6	8.60	32.0	0.885	7.90	14.2	10.4	43.0	0.720			
177.8	190.5	7.75	13.2	0.420	6.70	11.4	8.80	34.5	0.915	8.10	15.2	10.7	46.0	0.745			
190.5	203.2	7.95	14.1	0.435	6.85	12.2	9.05	37.0	0.945	8.30	16.2	10.9	49.0	0.770			
203.2	215.9	8.10	15.0	0.445	7.05	13.0	9.25	38.0	0.975	8.50	17.3	11.2	52.5	0.790			
228.6	241.3	8.45	16.8	0.470	7.35	14.5	9.65	44.0	1.03	8.90	19.3	11.7	58.5	0.835			
254	266.7	8.80	18.6	0.495	7.60	16.0	10.0	48.5	1.08	9.20	21.4	12.1	65.0	0.880			
279.4	292.1	8.10	20.3	0.520	7.90	17.6	10.4	53.5	1.13	9.55	23.4	12.6	71.0	0.920			
304.8	317.5	9.40	22.1	0.540	8.15	19.1	10.7	58.0	1.18	9.85	25.5	13.0	77.5	0.960			

Note: The upper two rows indicate the S series, and the other rows indicate the A series.

Bearing number			Approx. dimension			Mass	
Radial type	4-point contact type	Angular type	mm			Radial type	Angular type
			J	K	M	4-point contact type (approx.)	
KRS010	KXS	KYS	29	31.4	32.6	0.012	0.011
KRS015	KXS	KYS	41.7	44.1	45.2	0.018	0.017
KRA020	KXA	KYA	55.5	58.8	60.3	0.048	0.045
KRA025	KXA	KYA	68.2	71.5	73	0.059	0.054
KRA030	KXA	KYA	80.9	84.2	85.7	0.068	0.064
KRA035	KXA	KYA	93.6	96.9	98.4	0.082	0.077
KRA040	KXA	KYA	106.3	109.6	111	0.09	0.086
KRA042	KXA	KYA	112.7	115.9	117.4	0.095	0.091
KRA045	KXA	KYA	119	122.3	123.7	0.1	0.095
KRA047	KXA	KYA	125.4	128.6	130.1	0.104	0.1
KRA050	KXA	KYA	131.7	135	136.4	0.109	0.104
KRA055	KXA	KYA	144.4	147.7	149.1	0.118	0.113
KRA060	KXA	KYA	157.1	160.4	161.8	0.13	0.127
KRA065	KXA	KYA	169.8	173.1	174.5	0.14	0.136
KRA070	KXA	KYA	182.5	185.8	187.1	0.15	0.145
KRA075	KXA	KYA	195.2	198.5	199.8	0.16	0.154
KRA080	KXA	KYA	207.9	211.2	212.5	0.172	0.163
KRA090	KXA	KYA	233.3	236.6	237.9	0.2	0.186
KRA100	KXA	KYA	258.7	262	263.2	0.227	0.204
KRA110	KXA	KYA	284.1	287.4	288.6	0.236	0.227
KRA120	KXA	KYA	309.5	312.8	314	0.254	0.245

Special Application Bearings

Special Application Bearings

Ultra-Thin Section Type Ball Bearings



H series (with single-seal)
J series (with double-seal)

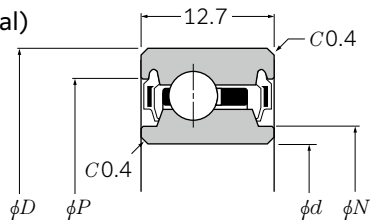

Radial type (with double-seal)

d 101.6 ~ 304.8mm

Boundary dimensions		Radial type			4-point contact type					Angular type				
mm		Basic load rating	static	Fatigue load limit	Basic load rating	static	dynamic	static	Fatigue load limit	Basic load rating	static	dynamic	static	Fatigue load limit
d	D	kN			Radial		kN			Radial		kN		
		C_r	C_{0r}	C_u	C_r	C_{0r}	C_a	C_{0a}	C_u	C_r	C_{0r}	C_a	C_{0a}	C_u
101.6	120.65	11.4	12.4	0.505	9.90	10.6	13.1	32.0	1.10	12.4	14.9	16.3	45.0	0.935
107.95	127	11.7	13.0	0.520	10.1	11.2	13.3	34.0	1.13	12.7	15.8	16.7	48.0	0.965
114.3	133.35	11.9	13.7	0.530	10.3	11.8	13.6	35.5	1.15	13.0	16.6	17.1	50.5	0.990
120.65	139.7	12.1	14.4	0.545	10.5	12.4	13.9	37.5	1.18	13.3	17.5	17.5	53.0	1.02
127	146.05	12.4	15.0	0.555	10.7	12.9	14.1	39.0	1.21	13.5	18.4	17.8	55.5	1.04
139.7	158.75	12.8	16.4	0.580	11.1	14.1	14.6	42.5	1.26	13.9	19.8	18.3	60.0	1.08
152.4	171.45	13.2	17.7	0.600	11.4	15.3	15.0	46.5	1.31	14.4	21.5	18.9	65.5	1.12
165.1	184.15	13.6	19.1	0.620	11.7	16.4	15.5	50.0	1.35	14.8	23.3	19.5	70.5	1.17
177.8	196.85	13.9	20.4	0.640	12.1	17.6	15.9	53.5	1.40	15.1	24.7	19.9	75.0	1.20
190.5	209.55	14.3	21.7	0.660	12.3	18.7	16.2	57.0	1.44	15.5	26.5	20.5	80.0	1.24
203.2	222.25	14.6	23.1	0.680	12.6	19.9	16.7	60.5	1.48	15.9	28.2	21.0	85.5	1.28
228.6	247.65	15.2	25.7	0.720	13.2	22.2	17.3	67.5	1.57	16.6	31.5	21.8	95.0	1.35
254	273.05	15.8	28.4	0.755	13.7	24.5	18.0	74.5	1.64	17.3	35.0	22.7	106	1.43
279.4	298.45	16.3	31.0	0.790	14.1	26.8	18.6	81.5	1.72	17.8	38.0	23.5	115	1.49
304.8	323.85	16.8	34.0	0.820	14.6	29.2	19.2	88.5	1.79	18.4	41.0	24.2	125	1.54

Ultra-Thin Section Type Ball Bearings

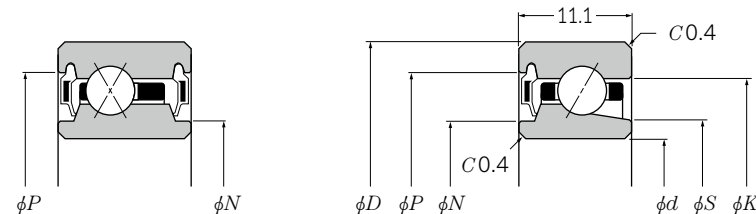

4-point contact type (with double-seal)

Angular type (with single-seal)

Bearing number			Approx. dimension				Mass	
Radial type	4-point contact type	Angular type	mm				Radial type	Angular type
			N	P	S	K	4-point contact type (approx.)	
KRJ040LL	KXJ	KYH	105.5	115.9	106.2	113.6	0.249	0.222
KRJ042LL	KXJ	KYH	111.8	122.2	112.6	120	0.263	0.236
KRJ045LL	KXJ	KYH	118.2	128.6	119.1	126.3	0.277	0.254
KRJ047LL	KXJ	KYH	124.6	135	125.3	132.7	0.295	0.268
KRJ050LL	KXJ	KYH	130.9	141.3	131.7	139	0.308	0.281
KRJ055LL	KXJ	KYH	143.6	154	144.4	151.7	0.336	0.304
KRJ060LL	KXJ	KYH	156.3	166.7	157.1	164.4	0.367	0.331
KRJ065LL	KXJ	KYH	169	179.4	169.8	177.1	0.395	0.354
KRJ070LL	KXJ	KYH	181.7	192.1	182.4	189.8	0.422	0.381
KRJ075LL	KXJ	KYH	194.4	204.8	195.2	202.5	0.45	0.404
KRJ080LL	KXJ	KYH	207.1	217.5	207.9	215.2	0.481	0.431
KRJ090LL	KXJ	KYH	232.5	242.9	233.4	240.6	0.535	0.5
KRJ100LL	KXJ	KYH	257.9	268.3	258.8	266	0.594	0.531
KRJ110LL	KXJ	KYH	283.3	293.7	284.2	291.4	0.648	0.581
KRJ120LL	KXJ	KYH	308.7	319.1	309.7	316.8	0.708	0.63

Special Application Bearings

Special Application Bearings



Fixed side SL type cylindrical roller bearing (open type)

Floating side SL type cylindrical roller bearing (open type)

SL type cylindrical roller bearing for sheaves (sealed type)

1. Types, design features, and characteristics

SL type cylindrical roller bearings are double-row full complement cylindrical roller bearings that have a thin cross-section and can withstand extremely large radial loads and impact loads. These bearings are suitable for a wide range of slow-moderate speed, heavily loaded

applications such as construction machinery, vehicles, steel machinery, and lifting machinery. These bearings can be produced both with and without seals. **Table 1** shows the characteristics of this bearing type.

Table 1 SL type cylindrical roller bearing types and characteristics

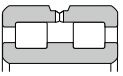
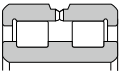
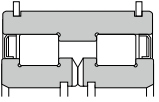
Type	Features
<p>Open type</p>  <p>SL01 type</p>  <p>SL02 type</p>	<ul style="list-style-type: none"> The SL01 type is used for fixed side bearings and the SL02 is used for float side bearings. The outer ring is divided in the circumferential direction by a special method and reconnected after rollers are embedded. The bearing side surface needs to be firmly fixed in the axial direction by the shoulders of shafts and housings. The outer ring has oil grooves and oil holes. The SL01 type can receive an axial load in both directions. Dimensions D_a and d_a are applied for the shoulder dimension of shafts and housings. However, when a moment load or a large axial load is to be used, dimensions J and K are recommended. The dimension table (from C-68 to C-71) shows dimension series codes d_a, D_a, J and K.
<p>Sealed type</p>  <p>SL04 type</p>	<ul style="list-style-type: none"> The SL04 type is only designed as the fixed side bearing. The inner ring is divided in the circumferential direction by a special method and reconnected after rollers are embedded. The bearing side surface needs to be firmly fixed in the axial direction by the shoulders of shafts and housings. The inner ring has oil grooves and oil holes. A radial load and an axial load in both directions can be applied to the bearing. The bearings are shielded, filled with grease, and have snap rings in the outer ring. These bearings are allow easy design into the application. The bearings are mainly used for sheaves. Surface coating treatment is applied to prevent rust.

Note: For SL type cylindrical roller bearings, three-row, four-row, and five-row bearings are also available besides the double-row. Please contact **NTN** Engineering.

2. Dimensional and rotational accuracy

SL type cylindrical roller bearings are made according to JIS class 0 (refer to **Table 6.4** (A-58 to A-59) in section "6. Bearing tolerances"). The outer ring accuracy of the SL01 type and the SL02 type is before division. Regarding the SL04 type, the inner ring accuracy is before surface treatment and division, and the outer ring accuracy is before surface treatment.

3. Radial internal clearance

Table 2 shows the radial internal clearance

Table 2 Radial internal clearance

Nominal bearing bore diameter d mm	CN (normal)		C3		C4	
	Over	Incl.	Min.	Max.	Min.	Max.
30	50		20	75	40	95
50	80		30	90	55	115
80	120		35	105	80	150
120	180		60	150	110	200
180	250		90	190	155	255
250	315		110	225	195	310
315	400		140	265	245	370
400	500		180	320	300	440

unit: μm

values. It should be noted that the values differ from standard cylindrical roller bearings.

4. Selection of recommended fits and radial internal clearance

Table 3 shows the recommended fits when the bearings are used in outer ring rotating applications such as sheaves and wheels.

Table 4 shows the relationship between the fits and the radial internal clearance.

It is necessary to equally apply load on the entire surface of the raceway end on the bearing side face at the time of assembly and removal.

Table 3 Recommended fits

Condition		Shaft tolerance class	Housing tolerance class
Outer ring rotational load	Heavy load with thin wall housing	g6 or h6	P7
	Ordinary or heavy load		N7 ¹⁾
	Light or fluctuating load		M7

1) N7 must be used for sheaves (to prevent snap ring from coming off).

Refer to **Table 7.2** (A-80) in section "7. Bearing fits" for the inner ring rotational load.

Table 4 Relationship between fits and radial internal clearance

		Housing fits													
		G 7	H 6	J 6	J 7	K 6	K 7	g 6	M 6	M 7	N 6	N 7	P 6	P 7	
Housing fits	g 6														
	h 6														
	j 5														
	j 6														
	k 5														
	k 6														
	m 5														
	m 6														
	n 5														
	n 6														
p 6															

Note: Use CN (normal) clearance when the shaft fit is g6, the housing fit is N7 (N6), and the speed is low (for sheaves, etc.)

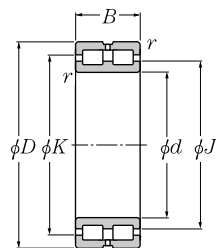

SL01-48 type
SL01-49 type
(fixed side)

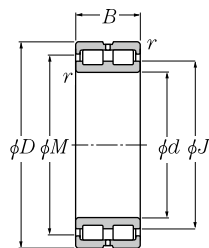

SL02-48 type
SL02-49 type
(floating side)

d 50 ~ 220mm

	Boundary dimensions			Basic load rating		Allowable speed		Bearing number		Dimensions			
	d	D	B	$r_{s \min}^{1)}$	C_r	C_{0r}	Grease lubrication	Oil lubrication	Fixed side	Floating side	J	K	M
50	72	22	0.6	49.5	83.0	2 000	4 000	SL01-4910	SL02-4910	58	63	64	1
60	85	25	1	73.0	136	1 700	3 300	SL01-4912	SL02-4912	69.5	74.5	75.5	1
70	100	30	1	105	193	1 400	2 900	SL01-4914	SL02-4914	81.5	88	89.5	1
80	110	30	1	111	215	1 300	2 500	SL01-4916	SL02-4916	90	97	98.5	1
90	125	35	1.1	150	300	1 100	2 200	SL01-4918	SL02-4918	103	111	112.5	1.5
100	140	40	1.1	194	400	1 000	2 000	SL01-4920	SL02-4920	116	125	126.5	2
110	150	40	1.1	202	430	910	1 800	SL01-4922	SL02-4922	125	134	135.5	2
120	165	45	1.1	226	480	830	1 700	SL01-4924	SL02-4924	138.5	148.5	150.5	3
130	180	50	1.5	262	555	770	1 500	SL01-4926	SL02-4926	149	160	162	4
140	190	50	1.5	272	595	710	1 400	SL01-4928	SL02-4928	159.5	170	172.5	4
150	190 210	40 60	1.1 2	235 410	575 865	670 670	1 300 1 300	SL01-4830 SL01-4930	SL02-4830 SL02-4930	165.5 171.5	173.5 186	175.5 189.5	2 4
160	200 220	40 60	1.1 2	241 425	605 935	630 630	1 300 1 300	SL01-4832 SL01-4932	SL02-4832 SL02-4932	173.5 185	182.5 199	184 203	2 4
170	215 230	45 60	1.1 2	265 435	650 980	590 590	1 200 1 200	SL01-4834 SL01-4934	SL02-4834 SL02-4934	186.5 194	196.5 208	198 211.5	3 4
180	225 250	45 69	1.1 2	275 550	695 1 230	560 560	1 100 1 100	SL01-4836 SL01-4936	SL02-4836 SL02-4936	199 206	209 222	211 225.5	3 4
190	240 260	50 69	1.5 2	315 565	785 1 290	530 530	1 100 1 100	SL01-4838 SL01-4938	SL02-4838 SL02-4938	208.5 216.5	219.5 232.5	221.5 235.5	4 4
200	250 280	50 80	1.5 2.1	320 665	825 1 500	500 500	1 000 1 000	SL01-4840 SL01-4940	SL02-4840 SL02-4940	219 232	230 250	232 253.5	4 5
220	270	50	1.5	340	905	450	910	SL01-4844	SL02-4844	240	251	253	4

1) Smallest allowable dimension for chamfer dimension r . 2) Effective movement amount in axial direction.
C-68

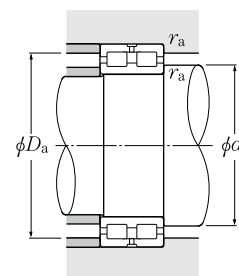

Fixed side

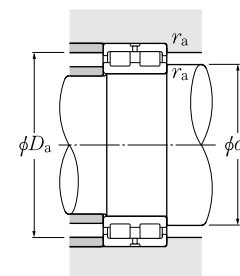

Floating side

Installation-related dimensions			Mass (approx.)	
$d_a^{3)}$	$D_a^{3)}$	r_{as}	Fixed side	Floating side
Min.	Max.	Max.		
54	68	0.6	0.3	0.29
65	80	1	0.46	0.44
75	95	1	0.78	0.75
85	105	1	0.88	0.85
96.5	118.5	1	1.35	1.3
106.5	133.5	1	1.95	1.9
116.5	143.5	1	2.15	2.1
126.5	158.5	1	2.95	2.85
138	172	1.5	3.95	3.8
148	182	1.5	4.2	4.1
156.5	183.5	1	2.9	2.8
159	201	2	6.65	6.45
166.5	193.5	1	3.05	2.9
169	211	2	7	6.8
176.5	208.5	1	4.1	3.95
179	221	2	7.35	7.1
186.5	218.5	1	4.3	4.15
189	241	2	10.7	10.5
198	232	1.5	5.65	5.45
199	251	2	11.2	10.9
208	242	1.5	5.9	5.7
211	269	2	15.7	15.3
228	262	1.5	6.4	6.2

3) If the bearing on the fixed side supports an eccentric axial load or a large axial load, shoulder dimension J and dimension K are recommended.
C-69

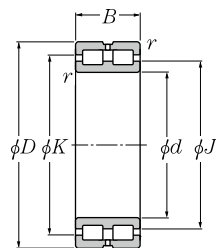

SL01-48 type
SL01-49 type
(fixed side)

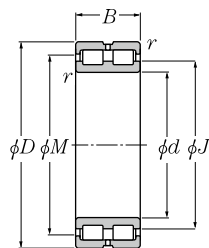

SL02-48 type
SL02-49 type
(floating side)

d 220 ~ 440mm

	Boundary dimensions			Basic load rating		Allowable speed		Bearing number		Dimensions			
	d	D	B	$r_{s \min}^{1)}$	C_r	C_{0r}	Grease lubrication min ⁻¹	Oil lubrication min ⁻¹	Fixed side	Floating side	J	K	M
220	300	80	2.1	695	1 620	450	910	SL01-4944	SL02-4944	249.5	267.5	271	5
240	300	60	2	510	1 330	420	830	SL01-4848	SL02-4848	261	275	276.5	4
	320	80	2.1	730	1 770	420	830	SL01-4948	SL02-4948	272.5	290.5	294	5
260	320	60	2	535	1 450	380	770	SL01-4852	SL02-4852	283	297	300	4
	360	100	2.1	1 070	2 520	380	770	SL01-4952	SL02-4952	297	320	324.5	6
280	350	69	2	685	1 860	360	710	SL01-4856	SL02-4856	308	324	327	4
	380	100	2.1	1 110	2 710	360	710	SL01-4956	SL02-4956	319	342	346	6
300	380	80	2.1	805	2 160	330	670	SL01-4860	SL02-4860	330	348	351	6
	420	118	3	1 580	3 800	330	670	SL01-4960	SL02-4960	344	371	377	6
320	400	80	2.1	835	2 310	310	630	SL01-4864	SL02-4864	353	371	374	6
	440	118	3	1 650	4 100	310	630	SL01-4964	SL02-4964	371	398	404	6
340	420	80	2.1	855	2 430	290	590	SL01-4868	SL02-4868	370	388	391	6
	460	118	3	1 690	4 300	290	590	SL01-4968	SL02-4968	388	416	421	6
360	440	80	2.1	885	2 580	280	560	SL01-4872	SL02-4872	393	411	414	6
	480	118	3	1 730	4 500	280	560	SL01-4972	SL02-4972	406	434	439	6
380	480	100	2.1	1 290	3 600	260	530	SL01-4876	SL02-4876	422	444	449	6
	520	140	4	2 300	5 900	260	530	SL01-4976	SL02-4976	437	469	475	7
400	540	140	4	2 410	6 200	250	500	SL01-4980	SL02-4980	450	484	490	7
420	560	140	4	2 470	6 500	240	480	SL01-4984	SL02-4984	472	505	512	7
440	600	160	4	3 000	7 850	230	450	SL01-4988	SL02-4988	503	540	546	7

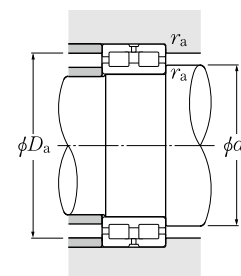

Fixed side

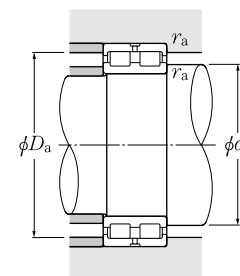

Floating side

	Installation-related dimensions			Mass (approx.)	
	$d_a^{3)}$ Min.	$D_a^{3)}$ Max.	r_{as} Max.	Fixed side	Floating side
231	289	2	17.1	16.6	
249	291	2	10.2	9.9	
251	309	2	18.4	17.9	
269	311	2	11	10.6	
271	349	2	32	31.2	
289	341	2	16	15.6	
291	369	2	33.9	33.1	
311	369	2	23	22.2	
313	407	2.5	53	51.9	
331	389	2	24.3	23.5	
333	427	2.5	56	54.9	
351	409	2	25.6	24.8	
353	447	2.5	59	57.8	
371	429	2	27	26	
373	467	2.5	62	60.8	
391	469	2	45.3	44	
396	504	3	92.3	90.5	
416	524	3	96.4	94.6	
436	544	3	101	98.6	
456	584	3	139	137	

1) Smallest allowable dimension for chamfer dimension r . 2) Effective movement amount in axial direction.
C-70

3) If the bearing on the fixed side supports an eccentric axial load or a large axial load, shoulder dimension J and dimension K are recommended.
C-71

● SL Type Cylindrical Roller Bearings for Sheaves

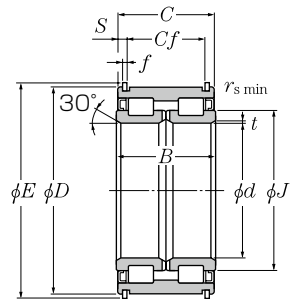

d 40 ~ 170mm

d	Boundary dimensions					Basic load rating			Allowable speed min ⁻¹ Grease lubrication	Bearing number	Dimensions				
	mm					dynamic kN	static				mm				
	D	B	C	t	r _{s min}	C _R	C _{0r}		J	E (approx.)	f	Cf	S		
40	68	38	37	0.8	0.6	79.5	116	2 500	SL04-5008NR	51	71.8	2	28	4.5	
45	75	40	39	0.8	0.6	95.5	144	2 200	SL04-5009NR	56.6	79	2	30	4.5	
50	80	40	39	0.8	0.6	100	158	2 000	SL04-5010NR	61	83.8	2	30	4.5	
55	90	46	45	1	0.6	118	193	1 800	SL04-5011NR	67.9	95	2.5	34	5.5	
60	95	46	45	1	0.6	123	208	1 700	SL04-5012NR	73.4	100	2.5	34	5.5	
65	100	46	45	1	0.6	128	224	1 500	SL04-5013NR	78	105	2.5	34	5.5	
70	110	54	53	1	0.6	171	285	1 400	SL04-5014NR	84.5	114.5	2.5	42	5.5	
75	115	54	53	1	0.6	197	325	1 300	SL04-5015NR	90	119.7	2.5	42	5.5	
80	125	60	59	1	0.6	205	350	1 300	SL04-5016NR	96.5	129.7	2.5	48	5.5	
85	130	60	59	1	0.6	214	380	1 200	SL04-5017NR	103.7	134.5	2.5	48	5.5	
90	140	67	66	1.5	0.6	305	540	1 100	SL04-5018NR	110	146.3	2.5	54	6	
95	145	67	66	1.5	0.6	310	560	1 100	SL04-5019NR	114.4	151.3	2.5	54	6	
100	150	67	66	1.5	0.6	330	580	1 000	SL04-5020NR	118.5	156.3	2.5	54	6	
110	170	80	79	1.8	1	385	695	910	SL04-5022NR	131.5	176.4	2.5	65	7	
120	180	80	79	1.8	1	400	750	830	SL04-5024NR	141.5	188.4	3	65	7	
130	200	95	94	1.8	1	535	1 000	770	SL04-5026NR	158	208.4	3	77	8.5	
140	210	95	94	1.8	1	600	1 120	710	SL04-5028NR	167	218.5	3	77	8.5	
150	225	100	99	2	1	690	1 290	670	SL04-5030NR	178.3	233.5	3	81	9	
160	240	109	108	2	1.1	720	1 390	630	SL04-5032NR	191	248.5	3	89	9.5	
170	260	122	121	2	1.1	925	1 790	590	SL04-5034NR	202.7	270.5	4	99	11	

Note: 1. The bearings have grease filled in. 2. Surface treatment is applied to bearings to prevent rust.
3. The bearings are non-contact shielded type bearings, but contact sealed type bearings are also available based on your request.

● SL Type Cylindrical Roller Bearings for Sheaves

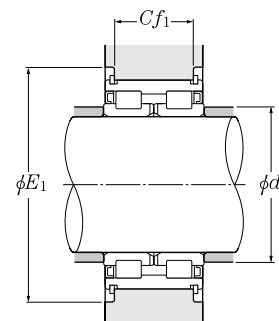

Installation-related dimensions			Mass
mm			
d _a (Min.)	E ₁	Cf ₁ ¹⁾	(approx.)
43.5	82	28	0.552
48.5	88	30	0.688
53.5	94	30	0.752
60	106	34	1.12
65	112	34	1.2
70	116	34	1.27
75	130	42	1.87
80	135	42	1.97
85	145	48	2.66
90	155	48	2.79
96	165	54	3.71
101	175	54	3.87
106	180	54	4.03
116.5	200	65	7
126.5	210	65	7.5
136.5	230	77	11.4
146.5	245	77	12.1
157	260	81	14.6
167	275	89	18.2
177	300	99	24.6

1) Tolerance of dimension Cf₁ SL04-5008NR ~ SL04-5034NR : -0.1 ~ -0.5mm
SL04-5036NR ~ SL04-5040NR : -0.1 ~ -0.7mm

● SL Type Cylindrical Roller Bearings for Sheaves

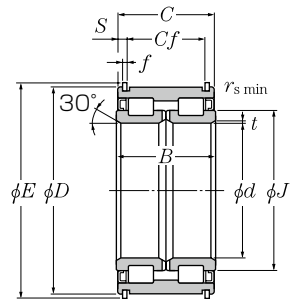

d 180 ~ 440mm

d	Boundary dimensions					Basic load rating		Allowable speed min ⁻¹ Grease lubrication	Bearing number	Dimensions				
	D	B	C	t	r _{s min}	dynamic kN	static C _{0r}			J	E mm (approx.)	f	Cf	S
180	280	136	135	2	1.1	1 090	2 140	560	SL04-5036NR	220	290.5	4	110	12.5
190	290	136	135	2	1.1	1 120	2 230	530	SL04-5038NR	226	300.5	4	110	12.5
200	310	150	149	2	1.1	1 310	2 650	500	SL04-5040NR	245.5	320.5	4	120	14.5
220	340	160	159	2.5	1.1	1 640	3 300	450	SL04-5044NR	260	357	6	130	14.5
240	360	160	159	2.5	1.1	1 710	3 550	420	SL04-5048NR	280.5	377	6	130	14.5
260	400	190	189	3	1.5	1 950	4 200	380	SL04-5052NR	310	417	7	154	17.5
280	420	190	189	3	1.5	2 170	4 700	360	SL04-5056NR	325	437	7	154	17.5
300	460	218	216	3	1.5	2 670	5 850	330	SL04-5060NR	363	481	8	176	20
320	480	218	216	3	1.5	2 720	6 100	310	SL04-5064NR	376	501	8	176	20
340	520	243	241	3.5	2	3 650	8 000	290	SL04-5068NR	406	545	8	194	23.5
360	540	243	241	3.5	2	3 750	8 300	280	SL04-5072NR	421	565	10	194	23.5
380	560	243	241	3.5	2	3 800	8 750	260	SL04-5076NR	442	585	10	194	23.5
400	600	272	270	3.5	2	4 250	9 950	250	SL04-5080NR	470	627	12	210	30
420	620	272	270	3.5	2	4 350	10 300	240	SL04-5084NR	486	647	12	210	30
440	650	280	278	4.5	3	4 500	11 000	230	SL04-5088NR	518	677	12	210	34

● SL Type Cylindrical Roller Bearings for Sheaves

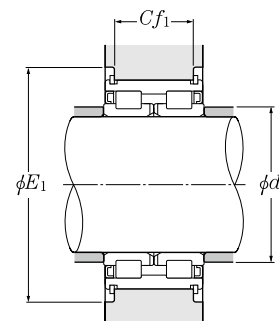

d _a (Min.)	Installation-related dimensions mm		Mass kg (approx.)
	E ₁	Cf ₁ ¹⁾	
187	320	110	32.3
197	330	110	33.7
207	350	120	43.5
228.5	380	130	55.5
248.5	400	130	59.5
270	445	154	90.7
290	465	154	96.2
310	510	176	137
330	530	176	144
352	580	194	194
372	600	194	203
392	620	194	212
412	675	210	281
432	695	210	292
456	725	210	331

Note: 1. The bearings have grease filled in. 2. Surface treatment is applied to bearings to prevent rust.
3. The bearings are non-contact shielded type bearings, but contact sealed type bearings are also available based on your request.

1) Tolerance of dimension Cf₁
SL04-5008NR ~ SL04-5034NR : -0.1 ~ -0.5mm
SL04-5036NR ~ SL04-5040NR : -0.1 ~ -0.7mm

● **ULTAGE Precision Rolling Bearings for Machine Tools**

For angular contact ball bearings for machine tools with a contact angle of 15° and bearing tolerance of JIS class 5 or higher, cylindrical roller bearings having bearing tolerance of JIS class 5 or higher, tapered roller bearings having bearing tolerance of JIS class 5 or higher, and bearings for supporting ball screws, see the special catalog "Precision rolling bearings (CAT. No. 2260/E)".

● **Bearings for Special Environments**

Bearings for special environments are bearings that can be used for clean environments and high vacuum environments, where conventional bearings would not be acceptable. Bearings for special environments can also be used for the development of space equipment, vacuum equipment, and semiconductor manufacturing equipment. For details, see the special catalog "Ultra final series bearings for clean environment (CAT. No. 3028/E)".

● **Rubber Molded Bearings**

Rubber molded bearings are rubber rollers made by baking and bonding urethane rubber directly to the outer diameter of small deep groove ball bearings. Rubber molded bearings are suitable for low vibration and low noise applications, and feed mechanisms that require accuracy. For details, see the special catalog "Rubber molded bearings (CAT. No. 3021/J)".

● **MEGAOHM™ Series Insulated Bearings**

Bearings used for electric equipment such as motors and generators may cause electrolytic corrosion due to leakage current, which shortens the bearing life. MEGAOHM™ series insulated bearings are the bearings developed to prevent this electrolytic corrosion. The series includes ceramic and resin type bearings. For details, see the special catalog "MEGAOHM™ series insulated bearings (CAT. No. 3030/E)".

● **Clutches/Torque Limiters**

1) **One-way clutch**

The driving force is transmitted only in one direction. In the opposite direction, the driving and idling can be switched by a clutch with a mechanism for idling. NTN provides a variety of one-way clutches to meet various needs.

For the clutch models, handling precautions, and other details, see the special catalog "Clutches (CAT. No. 2900/E)".

2) **Torque limiter units**

The NTN torque limiter unit (NTS type) is a unit composed of an inner ring, a coil spring, an external resin part, and a lid. When the torque acting between the inner ring and the external resin part is low, the inner ring and the outer resin part are rotated simultaneously. Under high torque conditions, the inner ring and the outer resin part are relatively rotated while keeping a constant torque.

For the torque limiter models, handling precautions, and other details, see the special catalog "Torque limiter units (CAT. No. 6404/J)".

Rolling Bearing Accessories

Rolling Bearing Accessories Contents

- Locknuts D- 2
- Nuts D- 8
- Lockwashers D-12
- Locking clips D-15
- Snap rings and grooves for rolling bearings D-16
- Balls D-20
- Needle rollers D-24



(For adapter sleeve, withdrawal sleeve and shaft)
Series AN

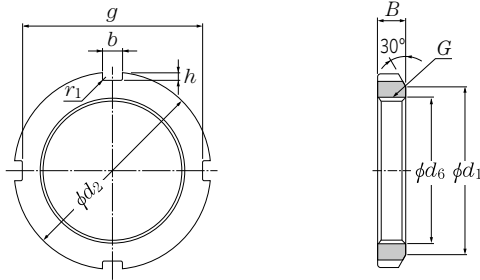

Number	Thread no.	Dimensions mm						Mass kg	(approx.)			
		d_2	d_1	g	b	h	d_6		B	r_1 Max.	Bore diameter no. of adapter ²⁾	Lockwasher no. ³⁾
AN00	M10 × 0.75	18	13.5	14	3	2	10.5	4	0.4	0.005	—	AW00
AN01	M12 × 1	22	17	18	3	2	12.5	4	0.4	0.007	—	AW01
AN02	M15 × 1	25	21	21	4	2	15.5	5	0.4	0.010	—	AW02
AN03	M17 × 1	28	24	24	4	2	17.5	5	0.4	0.013	—	AW03
AN04	M20 × 1	32	26	28	4	2	20.5	6	0.4	0.019	04	AW04
AN/22	M22 × 1	34	28	30	4	2	22.5	6	0.4	0.023	—	AW/22
AN05	M25 × 1.5	38	32	34	5	2	25.8	7	0.4	0.025	05	AW05
AN/28	M28 × 1.5	42	36	38	5	2	28.8	7	0.4	0.040	—	AW/28
AN06	M30 × 1.5	45	38	41	5	2	30.8	7	0.4	0.043	06	AW06
AN/32	M32 × 1.5	48	40	44	5	2	32.8	8	0.4	0.058	—	AW/32
AN07	M35 × 1.5	52	44	48	5	2	35.8	8	0.4	0.053	07	AW07
AN08	M40 × 1.5	58	50	53	6	2.5	40.8	9	0.5	0.085	08	AW08
AN09	M45 × 1.5	65	56	60	6	2.5	45.8	10	0.5	0.119	09	AW09
AN10	M50 × 1.5	70	61	65	6	2.5	50.8	11	0.5	0.148	10	AW10
AN11	M55 × 2	75	67	69	7	3	56	11	0.5	0.158	11	AW11
AN12	M60 × 2	80	73	74	7	3	61	11	0.5	0.174	12	AW12
AN13	M65 × 2	85	79	79	7	3	66	12	0.5	0.203	13	AW13
AN14	M70 × 2	92	85	85	8	3.5	71	12	0.5	0.242	14	AW14
AN15	M75 × 2	98	90	91	8	3.5	76	13	0.5	0.287	15	AW15
AN16	M80 × 2	105	95	98	8	3.5	81	15	0.6	0.397	16	AW16
AN17	M85 × 2	110	102	103	8	3.5	86	16	0.6	0.451	17	AW17
AN18	M90 × 2	120	108	112	10	4	91	16	0.6	0.556	18	AW18
AN19	M95 × 2	125	113	117	10	4	96	17	0.6	0.658	19	AW19
AN20	M100 × 2	130	120	122	10	4	101	18	0.6	0.698	20	AW20
AN21	M105 × 2	140	126	130	12	5	106	18	0.7	0.845	21	AW21
AN22	M110 × 2	145	133	135	12	5	111	19	0.7	0.965	22	AW22
AN23	M115 × 2	150	137	140	12	5	116	19	0.7	1.01	—	AW23
AN24	M120 × 2	155	138	145	12	5	121	20	0.7	1.08	24	AW24
AN25	M125 × 2	160	148	150	12	5	126	21	0.7	1.19	—	AW25
AN26	M130 × 2	165	149	155	12	5	131	21	0.7	1.25	26	AW26
AN27	M135 × 2	175	160	163	14	6	136	22	0.7	1.55	—	AW27
AN28	M140 × 2	180	160	168	14	6	141	22	0.7	1.56	28	AW28
AN29	M145 × 2	190	171	178	14	6	146	24	0.7	2.00	—	AW29
AN30	M150 × 2	195	171	183	14	6	151	24	0.7	2.03	30	AW30
AN31	M155 × 3	200	182	186	16	7	156.5	25	0.7	2.21	—	AW31
AN32	M160 × 3	210	182	196	16	7	161.5	25	0.7	2.59	32	AW32
AN33	M165 × 3	210	193	196	16	7	166.5	26	0.7	2.43	—	AW33
AN34	M170 × 3	220	193	206	16	7	171.5	26	0.7	2.80	34	AW34
AN36	M180 × 3	230	203	214	18	8	181.5	27	0.7	3.07	36	AW36
AN38	M190 × 3	240	214	224	18	8	191.5	28	0.7	3.39	38	AW38
AN40	M200 × 3	250	226	234	18	8	201.5	29	0.7	3.69	40	AW40

1) Thread shapes and dimensions are as per JIS B 0205-1 and JIS B 0205-4 (general metric threads).

2) Used for adapter series H31, H2, H3, and H23.

3) Washers with straight inner tabs that have code "X" after the number can also be used.

								(approx.) Withdrawal sleeve no.		Shaft dia. mm (for shaft)
AH30	AH240	AH31	AH241	AH2	AH32	AH3	AH23			
—	—	—	—	—	—	—	—	10		
—	—	—	—	—	—	—	—	12		
—	—	—	—	—	—	—	—	15		
—	—	—	—	—	—	—	—	17		
—	—	—	—	—	—	—	—	20		
—	—	—	—	—	—	—	—	22		
—	—	—	—	—	—	—	—	25		
—	—	—	—	—	—	—	—	28		
—	—	—	—	—	—	—	—	30		
—	—	—	—	—	—	—	—	32		
—	—	—	—	—	—	—	—	35		
—	—	—	—	—	—	—	—	40		
—	—	—	—	AH208	—	AH 308	AH2308	45		
—	—	—	—	AH209	—	AH 309	AH2309	50		
—	—	—	—	AH210	—	AHX310	AHX2310	55		
—	—	—	—	AH211	—	AHX311	AHX2311	60		
—	—	—	—	AH212	—	AHX312	AHX2312	65		
—	—	—	—	—	—	—	—	70		
—	—	—	—	AH213	—	AH 313	AH2313	75		
—	—	—	—	AH214	—	AH 314	AHX2314	80		
—	—	—	—	AH215	—	AH 315	AHX2315	85		
—	—	—	—	AH216	—	AH 316	AHX2316	90		
—	—	—	—	AH217	—	AHX317	AHX2317	95		
—	—	—	—	AH218	AHX3218	AHX318	AHX2318	100		
—	—	—	—	AH219	—	AHX319	AHX2319	105		
—	—	—	—	AH220	AHX3220	AHX320	AHX2320	110		
—	—	—	AH24122	AH221	—	AHX321	—	115		
—	—	—	—	AH222	—	AHX322	—	120		
—	AH24024	—	—	—	AHX3222	—	AHX2322	125		
AHX3024	—	AHX3122	AH24124	AH224	—	AHX324	—	130		
—	AH24026	—	—	—	AHX3224	—	AHX2324	135		
AHX3026	—	AHX3126	AH24126	AH226	—	AHX326	—	140		
—	AH24028	—	—	—	AHX3226	—	AHX2326	145		
AHX3028	—	AHX3128	AH24128	AH228	—	AHX328	—	150		
—	AH24030	—	—	—	AHX3228	—	AHX2328	155		
AHX3030	—	—	AH24130	AH230	—	—	—	160		
—	—	AHX3130	—	—	AHX3230	AHX330	AHX2330	165		
AH 3032	AH24032	—	AH24132	AH232	—	—	—	170		
AH 3034	AH24034	AH3132	AH24134	AH234	AH3232	AH332	AH2332	180		
AH 3036	AH24036	AH3134	AH24136	AH236	AH3234	AH334	AH2334	190		
—	AH24038	AH 3136	AH24138	—	AH3236	—	AH2336	200		

(For adapter sleeve and shaft)
Series AN

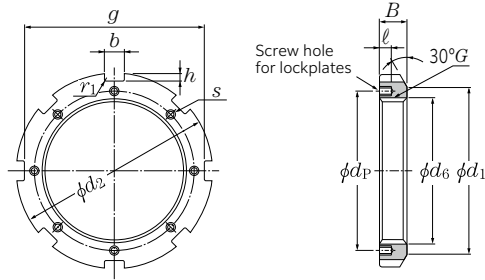

Number	Thread no.	Dimensions mm										Mass kg (approx.)		
		$G^{2)}$	d_2	d_1	g	b	h	d_6	B	r_1 Max.	l		Screw hole for lockplates	d_P
													$s^{2)}$	
AN44	Tr220 × 4	280	250	260	20	10	222	32	0.8	15	M8	238	5.20	
AN48	Tr240 × 4	300	270	280	20	10	242	34	0.8	15	M8	258	5.95	
AN52	Tr260 × 4	330	300	306	24	12	262	36	0.8	18	M10	281	8.05	
AN56	Tr280 × 4	350	320	326	24	12	282	38	0.8	18	M10	301	9.05	
AN60	Tr300 × 4	380	340	356	24	12	302	40	0.8	18	M10	326	11.8	
AN64	Tr320 × 5	400	360	376	24	12	322.5	42	0.8	18	M10	345	13.1	
AN68	Tr340 × 5	440	400	410	28	15	342.5	55	1	21	M12	372	23.1	
AN72	Tr360 × 5	460	420	430	28	15	362.5	58	1	21	M12	392	25.1	
AN76	Tr380 × 5	490	450	454	32	18	382.5	60	1	21	M12	414	30.9	
AN80	Tr400 × 5	520	470	484	32	18	402.5	62	1	27	M16	439	36.9	
AN84	Tr420 × 5	540	490	504	32	18	422.5	70	1	27	M16	459	43.5	
AN88	Tr440 × 5	560	510	520	36	20	442.5	70	1	27	M16	477	45.3	
AN92	Tr460 × 5	580	540	540	36	20	462.5	75	1	27	M16	497	50.4	
AN96	Tr480 × 5	620	560	580	36	20	482.5	75	1	27	M16	527	62.2	
AN100	Tr500 × 5	630	580	584	40	23	502.5	80	1	27	M16	539	63.3	

Bore diameter no. of adapter ³⁾	(approx.) Lockplate no.	Shaft dia. mm (for shaft)
	44	
48	AL44	240
52	AL52	260
56	AL52	280
60	AL60	300
64	AL64	320
68	AL68	340
72	AL68	360
76	AL76	380
80	AL80	400
84	AL80	420
88	AL88	440
92	AL88	460
96	AL96	480
/500	AL100	500

1) Thread shapes and dimensions are as per JIS B 0216 (metric trapezoidal screw threads).
2) Thread shapes and dimensions of screw holes are as per JIS B 0205-1 and JIS B 0205-4 (general metric threads).
3) Used for adapter series H31, H32, and H23.

(For adapter sleeve and shaft)
Series ANL

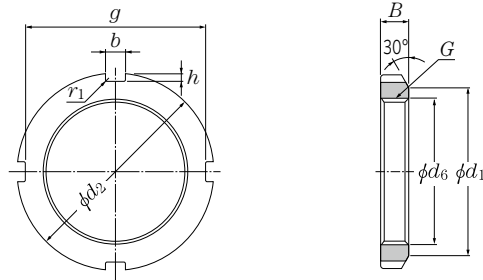

Number	Thread no.	Dimensions mm							Mass kg	Bore diameter no. of adapter ²⁾	(approx.) Lockwasher no. ³⁾	Shaft dia. mm (for shaft)	
		$G^{1)}$	d_2	d_1	g	b	h	d_6					B
ANL24	M120 × 2	145	133	135	12	5	121	20	0.7	0.78	24	AWL24	120
ANL26	M130 × 2	155	143	145	12	5	131	21	0.7	0.88	26	AWL26	130
ANL28	M140 × 2	165	151	153	14	6	141	22	0.7	0.99	28	AWL28	140
ANL30	M150 × 2	180	164	168	14	6	151	24	0.7	1.38	30	AWL30	150
ANL32	M160 × 3	190	174	176	16	7	161.5	25	0.7	1.56	32	AWL32	160
ANL34	M170 × 3	200	184	186	16	7	171.5	26	0.7	1.72	34	AWL34	170
ANL36	M180 × 3	210	192	194	18	8	181.5	27	0.7	1.95	36	AWL36	180
ANL38	M190 × 3	220	202	204	18	8	191.5	28	0.7	2.08	38	AWL38	190
ANL40	M200 × 3	240	218	224	18	8	201.5	29	0.7	2.98	40	AWL40	200

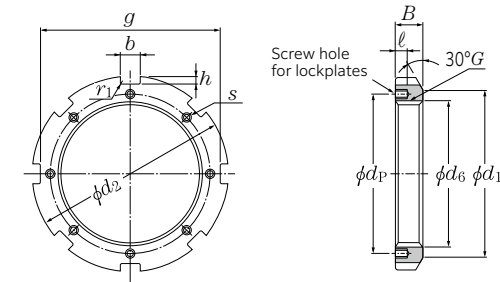

Number	Thread no.	Dimensions mm							r_1 Max.	l	Screw hole for lockplates $s^{2)}$	d_p	Mass kg (approx.)
		$G^{1)}$	d_2	d_1	g	b	h	d_6					
ANL44	Tr220 × 4	260	242	242	20	9	222	30	0.8	12	M6	229	3.09
ANL48	Tr240 × 4	290	270	270	20	10	242	34	0.8	15	M8	253	5.16
ANL52	Tr260 × 4	310	290	290	20	10	262	34	0.8	15	M8	273	5.67
ANL56	Tr280 × 4	330	310	310	24	10	282	38	0.8	15	M8	293	6.78
ANL60	Tr300 × 4	360	336	336	24	12	302	42	0.8	15	M8	316	9.62
ANL64	Tr320 × 5	380	356	356	24	12	322.5	42	0.8	15	M8	335	9.94
ANL68	Tr340 × 5	400	376	376	24	12	342.5	45	1	15	M8	355	11.7
ANL72	Tr360 × 5	420	394	394	28	13	362.5	45	1	15	M8	374	12.0
ANL76	Tr380 × 5	450	422	422	28	14	382.5	48	1	18	M10	398	14.9
ANL80	Tr400 × 5	470	442	442	28	14	402.5	52	1	18	M10	418	16.9
ANL84	Tr420 × 5	490	462	462	32	14	422.5	52	1	18	M10	438	17.4
ANL88	Tr440 × 5	520	490	490	32	15	442.5	60	1	21	M12	462	26.2
ANL92	Tr460 × 5	540	510	510	32	15	462.5	60	1	21	M12	482	29.6
ANL96	Tr480 × 5	560	530	530	36	15	482.5	60	1	21	M12	502	28.3
ANL100	Tr500 × 5	580	550	550	36	15	502.5	68	1	21	M12	522	33.6

- 1) Thread shapes and dimensions are as per JIS B 0216 (metric trapezoidal screw threads).
- 2) Thread shapes and dimensions of screw holes are as per JIS B 0205-1 and JIS B 0205-4 (general metric threads).
- 3) Applied to adapter series H30.

Bore diameter no. of adapter ²⁾	(approx.) Lockplate no.	Shaft dia. mm (for shaft)	Number
48	ALL48	240	ANL48
52	ALL48	260	ANL52
56	ALL56	280	ANL56
60	ALL60	300	ANL60
64	ALL64	320	ANL64
68	ALL64	340	ANL68
72	ALL72	360	ANL72
76	ALL76	380	ANL76
80	ALL76	400	ANL80
84	ALL84	420	ANL84
88	ALL88	440	ANL88
92	ALL88	460	ANL92
96	ALL96	480	ANL96
/500	ALL96	500	ANL100

- 1) Thread shapes and dimensions are as per JIS B 0205-1 and JIS B 0205-4 (general metric threads).
- 2) Applied to adapter series H30.
- 3) Washers with straight inner tabs that have code "X" after the number can also be used.

(For withdrawal sleeve)
Series HN

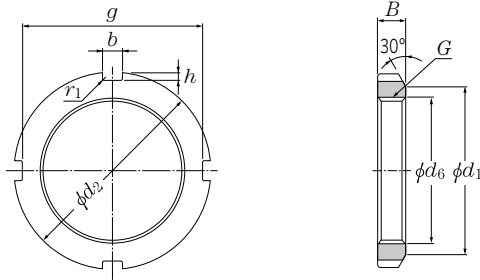

Number	Thread no.	Dimensions mm							Mass kg		(approx.) Withdrawal sleeve no.		
		G ¹⁾	d ₂	d ₁	g	b	h	d ₆	B	r ₁ Max.(approx.)	AH240	AH31	AH241
HN42	Tr210 × 4	270	238	250	20	10	212	30	0.8	4.75	AH24040	AH 3138	AH24140H
HN44	Tr220 × 4	280	250	260	20	10	222	32	0.8	5.35	—	AH 3140	—
HN46	Tr230 × 4	290	260	270	20	10	232	34	0.8	5.80	AH24044H	—	AH24144H
HN48	Tr240 × 4	300	270	280	20	10	242	34	0.8	6.20	—	AH 3144	—
HN50	Tr250 × 4	320	290	300	20	10	252	36	0.8	7.00	AH24048H	—	—
HN52	Tr260 × 4	330	300	306	24	12	262	36	0.8	8.55	—	AH 3148	AH24148H
HN54	Tr270 × 4	340	310	316	24	12	272	38	0.8	9.20	AH24052H	—	—
HN56	Tr280 × 4	350	320	326	24	12	282	38	0.8	10.0	—	—	AH24152H
HN58	Tr290 × 4	370	330	346	24	12	292	40	0.8	11.8	AH24056H	AH 3152	—
HN60	Tr300 × 4	380	340	356	24	12	302	40	0.8	12.0	—	—	AH24156H
HN62	Tr310 × 5	390	350	366	24	12	312.5	42	0.8	13.4	AH24060H	AH 3156	—
HN64	Tr320 × 5	400	360	376	24	12	322.5	42	0.8	13.5	—	—	AH24160H
HN66	Tr330 × 5	420	380	390	28	15	332.5	52	1	20.4	AH24064H	AH 3160	—
HN68	Tr340 × 5	440	400	410	28	15	342.5	55	1	24.5	—	—	AH24164H
HN70	Tr350 × 5	450	410	420	28	15	352.5	55	1	25.2	—	AH 3164	—
HN72	Tr360 × 5	460	420	430	28	15	362.5	58	1	27.5	—	—	AH24168H
HN74	Tr370 × 5	470	430	440	28	15	372.5	58	1	28.2	—	AH 3168	—
HN76	Tr380 × 5	490	450	454	32	18	382.5	60	1	33.5	—	—	AH24172H
HN80	Tr400 × 5	520	470	484	32	18	402.5	62	1	40.0	—	AH 3172	AH24176H
HN84	Tr420 × 5	540	490	504	32	18	422.5	70	1	46.9	—	AH 3176	AH24180H
HN88	Tr440 × 5	560	510	520	36	20	442.5	70	1	48.5	—	AH 3180	AH24184H
HN92	Tr460 × 5	580	540	540	36	20	462.5	75	1	55.0	—	AH 3184	AH24188H
HN96	Tr480 × 5	620	560	580	36	20	482.5	75	1	67.0	—	AHX3188	AH24192H
HN100	Tr500 × 5	630	580	584	40	23	502.5	80	1	69.0	—	—	—
HN102	Tr510 × 6	650	590	604	40	23	513	80	1	75.0	—	AHX3192	—
HN106	Tr530 × 6	670	610	624	40	23	533	80	1	78.0	—	AHX3196	—
HN110	Tr550 × 6	700	640	654	40	23	553	80	1	92.5	—	—	—

(approx.) Withdrawal sleeve no.		
AH22	AH32	AH23
AH2238	AH 3238	AH2338
AH2240	AH 3240	AH2340
—	—	—
AH2244	—	AH2344
—	—	—
AH2248	—	AH2348
—	—	—
—	—	—
AH2252	—	AH2352
—	—	—
AH2256	—	AH2356
—	—	—
AH2260	AH 3260	—
—	—	—
AH2264	AH 3264	—
—	—	—
—	AH 3268	—
—	—	—
—	AH 3272	—
—	AH 3276	—
—	AH 3280	—
—	AH 3284	—
—	AHX3288	—
—	—	—
—	AHX3292	—
—	AHX3296	—
—	—	—

1) Thread shapes and dimensions are as per JIS B 0216 (metric trapezoidal screw threads).
Note: Number HN54 indicates dimensions that are not indicated in JIS B 1554.

(For withdrawal sleeve)
Series HNL

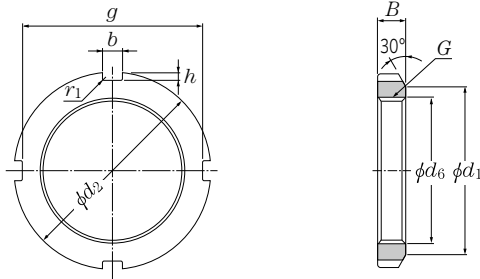

Number	Thread no.	Dimensions mm							Mass kg		(approx.)		
		$G^{1)}$	d_2	d_1	g	b	h	d_6	B	r_1 Max.(approx.)	Withdrawal sleeve no.		
											AH30	AH240	AH2
HNL41	Tr205 × 4	250	232	234	18	8	207	30	0.8	3.43	AH 3038	—	AH238
HNL43	Tr215 × 4	260	242	242	20	9	217	30	0.8	3.72	AH 3040	—	AH240
HNL47	Tr235 × 4	280	262	262	20	9	237	34	0.8	4.60	AH 3044	—	AH244
HNL52	Tr260 × 4	310	290	290	20	10	262	34	0.8	5.80	AH 3048	—	AH248
HNL56	Tr280 × 4	330	310	310	24	10	282	38	0.8	6.72	AH 3052	—	AH252
HNL60	Tr300 × 4	360	336	336	24	12	302	42	0.8	9.60	AH 3056	—	AH256
HNL64	Tr320 × 5	380	356	356	24	12	322.5	42	1	10.3	AH 3060	—	—
HNL69	Tr345 × 5	410	384	384	28	13	347.5	45	1	11.5	AH 3064	—	—
HNL72	Tr360 × 5	420	394	394	28	13	362.5	45	1	12.1	—	AH24068H	—
HNL73	Tr365 × 5	430	404	404	28	13	367.5	48	1	14.2	AH 3068	—	—
HNL76	Tr380 × 5	450	422	422	28	14	382.5	48	1	16.0	—	AH24072H	—
HNL77	Tr385 × 5	450	422	422	28	14	387.5	48	1	15.0	AH 3072	—	—
HNL80	Tr400 × 5	470	442	442	28	14	402.5	52	1	18.5	—	AH24076H	—
HNL82	Tr410 × 5	480	452	452	32	14	412.5	52	1	19.0	AH 3076	—	—
HNL84	Tr420 × 5	490	462	462	32	14	422.5	52	1	19.4	—	AH24080H	—
HNL86	Tr430 × 5	500	472	472	32	14	432.5	52	1	19.8	AH 3080	—	—
HNL88	Tr440 × 5	520	490	490	32	15	442.5	60	1	27.0	—	AH24084H	—
HNL90	Tr450 × 5	520	490	490	32	15	452.5	60	1	23.8	AH 3084	—	—
HNL92	Tr460 × 5	540	510	510	32	15	462.5	60	1	28.0	—	AH24088H	—
HNL94	Tr470 × 5	540	510	510	32	15	472.5	60	1	25.0	AHX3088	—	—
HNL96	Tr480 × 5	560	530	530	36	15	482.5	60	1	29.5	—	—	—
HNL98	Tr490 × 5	580	550	550	36	15	492.5	60	1	34.0	AHX3092	—	—
HNL100	Tr500 × 5	580	550	550	36	15	502.5	68	1	35.0	—	—	—
HNL104	Tr520 × 6	600	570	570	36	15	523	68	1	37.0	AHX3096	—	—
HNL106	Tr530 × 6	630	590	590	40	20	533	68	1	47.0	—	—	—
HNL108	Tr540 × 6	630	590	590	40	20	543	68	1	43.5	—	—	—

1) Thread shapes and dimensions are as per JIS B 0216 (metric trapezoidal screw threads).

Series AWL

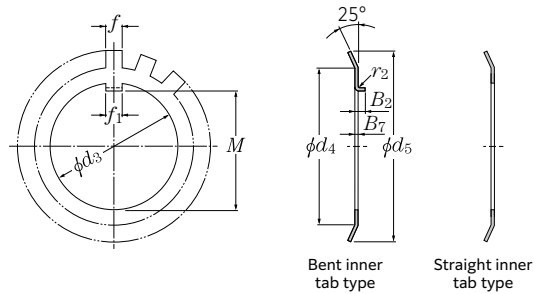

Number		Dimensions mm							No. of tabs		Mass kg	(approx.)		Shaft dia. mm (for shaft)	
Bent inner tab type	Straight inner tab type	d_3	M	f_1	B_7	f	d_4	d_5	Bent inner tab type r_2	B_2	100 pieces (approx.)	Bore diameter no. of adapter ¹⁾	Nut no.		
AWL24	AWL24X	120	115	14	2	12	133	155	1.5	8	19	7.70	24	ANL24	120
AWL26	AWL26X	130	125	14	2	12	143	165	1.5	8	19	8.70	26	ANL26	130
AWL28	AWL28X	140	135	16	2	14	151	175	1.5	10	19	10.9	28	ANL28	140
AWL30	AWL30X	150	145	16	2	14	164	190	1.5	10	19	11.3	30	ANL30	150
AWL32	AWL32X	160	154	18	2.5	16	174	200	1.5	10.5	19	16.2	32	ANL32	160
AWL34	AWL34X	170	164	18	2.5	16	184	210	1.5	10.5	19	19.0	34	ANL34	170
AWL36	AWL36X	180	174	20	2.5	18	192	220	1.5	10.5	19	18.0	36	ANL36	180
AWL38	AWL38X	190	184	20	2.5	18	202	230	1.5	10.5	19	20.5	38	ANL38	190
AWL40	AWL40X	200	194	20	2.5	18	218	250	1.5	10.5	19	21.4	40	ANL40	200

1) Used for adapter series H31, H32, and H23.

Note: For wide slit type adapter sleeves that have no suffix "X" after the adapter number, either straight or bent inner tab washers can be used.

Series AL, ALL

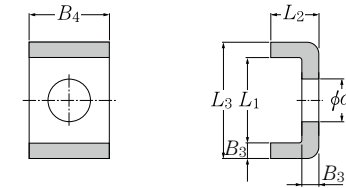

Number	Dimensions mm						Mass kg	(approx.)
	B_3	B_4	L_2	d_7	L_1	L_3	100 pieces (approx.)	Nut no.
AL44	4	20	12	9	22.5	30.5	2.60	AN44, AN48
AL52	4	24	12	12	25.5	33.5	3.39	AN52, AN56
AL60	4	24	12	12	30.5	38.5	3.79	AN60
AL64	5	24	15	12	31	41	5.35	AN64
AL68	5	28	15	14	38	48	6.65	AN68, AN72
AL76	5	32	15	14	40	50	7.96	AN76
AL80	5	32	15	18	45	55	8.20	AN80, AN84
AL88	5	36	15	18	43	53	9.00	AN88, AN92
AL96	5	36	15	18	53	63	10.4	AN96
AL100	5	40	15	18	45	55	10.5	AN100

Note: This series uses series H31, H32, and H23 adapters.

Number	Dimensions mm						Mass kg	(approx.)
	B_3	B_4	L_2	d_7	L_1	L_3	100 pieces (approx.)	Nut no.
ALL44	4	20	12	7	13.5	21.5	2.12	ANL44
ALL48	4	20	12	9	17.5	25.5	2.29	ANL48, ANL52
ALL56	4	24	12	9	17.5	25.5	2.92	ANL56
ALL60	4	24	12	9	20.5	28.5	3.16	ANL60
ALL64	5	24	15	9	21	31	4.56	ANL64, ANL68
ALL72	5	28	15	9	20	30	5.03	ANL72
ALL76	5	28	15	12	24	34	5.28	ANL76, ANL80
ALL84	5	32	15	12	24	34	6.11	ANL84
ALL88	5	32	15	14	28	38	6.45	ANL88, ANL92
ALL96	5	36	15	14	28	38	7.29	ANL96, ANL100

Note: This series uses H30 adapters.

Snap Rings and Grooves for Rolling Bearings



Snap rings
For dimension series 18 and 19 bearings

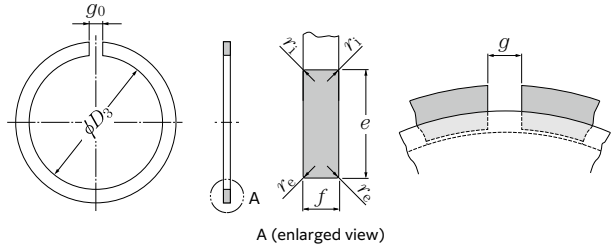

A (enlarged view)

Unit: mm

Number	Bearing outside diameter		Snap rings Bore diameter of D_3		Tolerance of Δ_{D3S}		e		f		Snap ring fitted inside groove ¹⁾		(approx.) Thickness variation				Bearing bore diameter series	
	D	D_3	Upper	Lower	Max.	Min.	Max.	Min.	D_2	g	g_0	r_1	r_e	V_f	18	19	d	
NR1022	22	20.5	0	-0.3	2.00	1.85	0.7	0.6	24.8	2	1	0.2	0.1	0.06	—	10	—	
NR1024	24	22.5	0	-0.3	2.00	1.85	0.7	0.6	26.8	2	1	0.2	0.1	0.06	—	12	—	
NR1028	28	26.4	0	-0.3	2.05	1.90	0.85	0.75	30.8	3	2	0.25	0.15	0.06	—	15	—	
NR1030	30	28.3	0	-0.3	2.05	1.90	0.85	0.75	32.8	3	2	0.25	0.15	0.06	—	17	—	
NR1032	32	30.3	0	-0.3	2.05	1.90	0.85	0.75	34.8	3	2	0.25	0.15	0.06	20	—		
NR1034	34	32.3	0	-0.3	2.05	1.90	0.85	0.75	36.8	3	2	0.25	0.15	0.06	22	—		
NR1037	37	35.3	0	-0.3	2.05	1.90	0.85	0.75	39.8	3	2	0.25	0.15	0.06	25	20		
NR1039	39	37.3	0	-0.3	2.05	1.90	0.85	0.75	41.8	3	2	0.25	0.15	0.06	—	22	—	
NR1040	40	38.3	0	-0.3	2.05	1.90	0.85	0.75	42.8	3	2	0.25	0.15	0.06	28	—		
NR1042	42	40.3	0	-0.4	2.05	1.90	0.85	0.75	44.8	3	2	0.25	0.15	0.06	30	25		
NR1044	44	42.3	0	-0.4	2.05	1.90	0.85	0.75	46.8	4	2.5	0.25	0.15	0.06	32	—		
NR1045	45	43.3	0	-0.4	2.05	1.90	0.85	0.75	47.8	4	2.5	0.25	0.15	0.06	—	28	—	
NR1047	47	45.3	0	-0.4	2.05	1.90	0.85	0.75	49.8	4	2.5	0.25	0.15	0.06	35	30		
NR1052	52	50.3	0	-0.4	2.05	1.90	0.85	0.75	54.8	4	2.5	0.25	0.15	0.06	40	32		
NR1055	55	53.3	0	-0.4	2.05	1.90	0.85	0.75	57.8	4	2.5	0.25	0.15	0.06	—	35	—	
NR1058	58	56.3	0	-0.6	2.05	1.90	0.85	0.75	60.8	4	2.5	0.25	0.15	0.06	45	—		
NR1062	62	60.2	0	-0.6	2.05	1.90	0.85	0.75	64.8	4	2.5	0.25	0.15	0.06	—	40	—	
NR1065	65	63.2	0	-0.6	2.05	1.90	0.85	0.75	67.8	4	2.5	0.25	0.15	0.06	50	—		
NR1068	68	66.2	0	-0.6	2.05	1.90	0.85	0.75	70.8	5	3	0.25	0.15	0.06	—	45	—	
NR1072	72	70.2	0	-0.6	2.05	1.90	0.85	0.75	74.8	5	3	0.25	0.15	0.06	55	50		
NR1078	78	75.7	0	-0.6	3.25	3.10	1.12	1.02	82.7	5	3	0.4	0.3	0.06	60	—		
NR1080	80	77.4	0	-0.6	3.25	3.10	1.12	1.02	84.4	5	3	0.4	0.3	0.06	—	55	—	
NR1085	85	82.4	0	-0.6	3.25	3.10	1.12	1.02	89.4	5	3	0.4	0.3	0.06	65	60		
NR1090	90	87.4	0	-0.6	3.25	3.10	1.12	1.02	94.4	5	3	0.4	0.3	0.06	70	65		
NR1095	95	92.4	0	-0.6	3.25	3.10	1.12	1.02	99.4	5	3	0.4	0.3	0.06	75	—		
NR1100	100	97.4	0	-0.6	3.25	3.10	1.12	1.02	104.4	5	3	0.4	0.3	0.06	80	70		
NR1105	105	101.9	0	-0.8	4.04	3.89	1.12	1.02	110.7	5	3	0.4	0.3	0.06	—	75	—	
NR1110	110	106.9	0	-0.8	4.04	3.89	1.12	1.02	115.7	5	3	0.4	0.3	0.06	85	80		
NR1115	115	111.9	0	-0.8	4.04	3.89	1.12	1.02	120.7	5	3	0.4	0.3	0.06	90	—		
NR1120	120	116.9	0	-0.8	4.04	3.89	1.12	1.02	125.7	7	4	0.4	0.3	0.06	95	85		
NR1125	125	121.8	0	-0.8	4.04	3.89	1.12	1.02	130.7	7	4	0.4	0.3	0.06	100	90		
NR1130	130	126.8	0	-0.8	4.04	3.89	1.12	1.02	135.7	7	4	0.4	0.3	0.06	105	95		
NR1140	140	136.8	0	-1.0	4.04	3.89	1.7	1.6	145.7	7	4	0.6	0.5	0.06	110	100		
NR1145	145	141.8	0	-1.0	4.04	3.89	1.7	1.6	150.7	7	4	0.6	0.5	0.06	—	105	—	
NR1150	150	146.8	0	-1.2	4.04	3.89	1.7	1.6	155.7	7	4	0.6	0.5	0.06	120	110		
NR1165	165	161	0	-1.2	4.85	4.70	1.7	1.6	171.5	7	4	0.6	0.5	0.06	130	120		
NR1175	175	171	0	-1.2	4.85	4.70	1.7	1.6	181.5	10	6	0.6	0.5	0.06	140	—		
NR1180	180	176	0	-1.2	4.85	4.70	1.7	1.6	186.5	10	6	0.6	0.5	0.06	—	130	—	
NR1190	190	186	0	-1.4	4.85	4.70	1.7	1.6	196.5	10	6	0.6	0.5	0.06	150	140		
NR1200	200	196	0	-1.4	4.85	4.70	1.7	1.6	206.5	10	6	0.6	0.5	0.06	160	—		

1) The snap ring must be fitted inside the groove in the radius direction free from looseness.

Snap Rings and Grooves for Rolling Bearings



Groove

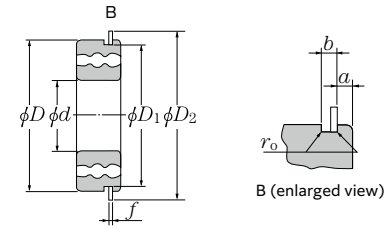

B (enlarged view)

Unit: mm

Bearing outside diameter	Groove diameter	Dimension series						Groove width	Fillet radius of groove bottom
		18		19		Max.	Min.		
D	D_1	Max.	Min.	Max.	Min.			Max.	Min.
22	20.8	20.5	—	—	1.05	0.90	1.05	0.8	0.2
24	22.8	22.5	—	—	1.05	0.90	1.05	0.8	0.2
28	26.7	26.4	—	—	1.30	1.15	1.20	0.95	0.25
30	28.7	28.4	—	—	1.30	1.15	1.20	0.95	0.25
32	30.7	30.4	1.30	1.15	—	—	1.20	0.95	0.25
34	32.7	32.4	1.30	1.15	—	—	1.20	0.95	0.25
37	35.7	35.4	1.30	1.15	1.70	1.55	1.20	0.95	0.25
39	37.7	37.4	—	—	1.70	1.55	1.20	0.95	0.25
40	38.7	38.4	1.30	1.15	—	—	1.20	0.95	0.25
42	40.7	40.4	1.30	1.15	1.70	1.55	1.20	0.95	0.25
44	42.7	42.4	1.30	1.15	—	—	1.20	0.95	0.25
45	43.7	43.4	—	—	1.70	1.55	1.20	0.95	0.25
47	45.7	45.4	1.30	1.15	1.70	1.55	1.20	0.95	0.25
52	50.7	50.4	1.30	1.15	1.70	1.55	1.20	0.95	0.25
55	53.7	53.4	—	—	1.70	1.55	1.20	0.95	0.25
58	56.7	56.4	1.30	1.15	—	—	1.20	0.95	0.25
62	60.7	60.3	—	—	1.70	1.55	1.20	0.95	0.25
65	63.7	63.3	1.30	1.15	—	—	1.20	0.95	0.25
68	66.7	66.3	—	—	1.70	1.55	1.20	0.95	0.25
72	70.7	70.3	1.70	1.55	1.70	1.55	1.20	0.95	0.25
78	76.2	75.8	1.70	1.55	—	—	1.6	1.3	0.4
80	77.9	77.5	—	—	2.1	1.9	1.6	1.3	0.4
85	82.9	82.5	1.70	1.55	2.1	1.9	1.6	1.3	0.4
90	87.9	87.5	1.70	1.55	2.1	1.9	1.6	1.3	0.4
95	92.9	92.5	1.70	1.55	—	—	1.6	1.3	0.4
100	97.9	97.5	1.70	1.55	2.5	2.3	1.6	1.3	0.4
105	102.6	102.1	—	—	2.5	2.3	1.6	1.3	0.4
110	107.6	107.1	2.1	1.9	2.5	2.3	1.6	1.3	0.4
115	112.6	112.1	2.1	1.9	—	—	1.6	1.3	0.4
120	117.6	117.1	2.1	1.9	3.3	3.1	1.6	1.3	0.4
125	122.6	122.1	2.1	1.9	3.3	3.1	1.6	1.3	0.4
130	127.6	127.1	2.1	1.9	3.3	3.1	1.6	1.3	0.4
140	137.6	137.1	2.5	2.3	3.3	3.1	2.2	1.9	0.6
145	142.6	142.1	—	—	3.3	3.1	2.2	1.9	0.6
150	147.6	147.1	2.5	2.3	3.3	3.1	2.2	1.9	0.6
165	161.8	161.3	3.3	3.1	3.7	3.5	2.2	1.9	0.6
175	171.8	171.3	3.3	3.1	—	—	2.2	1.9	0.6
180	176.8	176.3	—	—	3.7	3.5	2.2	1.9	0.6
190	186.8	186.3	3.3	3.1	3.7	3.5	2.2	1.9	0.6
200	196.8	196.3	3.3	3.1	—	—	2.2	1.9	0.6

● Snap Rings and Grooves for Rolling Bearings



Snap rings
For diameter series 0, 2, 3 and 4 bearings

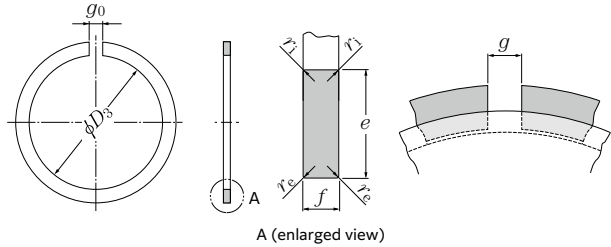

Unit: mm

Number	Bearing outside diameter <i>D</i>	Snap rings		Snap rings fitted inside groove ¹⁾				(approx.)				Bearing bore diameter dimension series						
		Bore diameter <i>D</i> ₃	Tolerance of <i>D</i> ₃	<i>e</i>	<i>f</i>	<i>D</i> ₂	<i>g</i>	<i>g</i> ₀	<i>r</i> ₁	<i>r</i> _e	<i>V</i> _f	0	2	3	4			
		Upper	Lower	Max.	Min.	Max.	Min.	Max.	Approx.	Min.	Min.	Max.						
NR30	30	27.9	0	-0.4	3.25	3.10	1.12	1.02	34.7	3	2	0.4	0.3	0.06	—	10	9	8
NR32	32	29.9	0	-0.4	3.25	3.10	1.12	1.02	36.7	3	2	0.4	0.3	0.06	15	12	—	9
NR35	35	32.9	0	-0.4	3.25	3.10	1.12	1.02	39.7	3	2	0.4	0.3	0.06	17	15	10	—
NR37	37	34.5	0	-0.4	3.25	3.10	1.12	1.02	41.3	3	2	0.4	0.3	0.06	—	—	12	10
NR40	40	37.8	0	-0.4	3.25	3.10	1.12	1.02	44.6	3	2	0.4	0.3	0.06	—	17	—	—
NR42	42	39.5	0	-0.5	3.25	3.10	1.12	1.02	46.3	3	2	0.4	0.3	0.06	20	—	15	12
NR44	44	41.5	0	-0.5	3.25	3.10	1.12	1.02	48.3	3	2	0.4	0.3	0.06	22	—	—	—
NR47	47	44.3	0	-0.5	4.04	3.89	1.12	1.02	52.7	4	2.5	0.4	0.3	0.06	25	20	17	—
NR50	50	47.3	0	-0.5	4.04	3.89	1.12	1.02	55.7	4	2.5	0.4	0.3	0.06	—	22	—	—
NR52	52	49.4	0	-0.5	4.04	3.89	1.12	1.02	57.9	4	2.5	0.4	0.3	0.06	28	25	20	15
NR55	55	52.3	0	-0.5	4.04	3.89	1.12	1.02	60.7	4	2.5	0.4	0.3	0.06	30	—	—	—
NR56	56	53.2	0	-0.6	4.04	3.89	1.12	1.02	61.7	4	2.5	0.4	0.3	0.06	—	—	22	—
NR58	58	55.2	0	-0.6	4.04	3.89	1.12	1.02	63.7	4	2.5	0.4	0.3	0.06	32	28	—	—
NR62	62	59.0	0	-0.6	4.04	3.89	1.7	1.6	67.7	4	2.5	0.6	0.5	0.06	35	30	25	17
NR65	65	62.0	0	-0.6	4.04	3.89	1.7	1.6	70.7	4	2.5	0.6	0.5	0.06	—	32	—	—
NR68	68	64.2	0	-0.6	4.85	4.70	1.7	1.6	74.6	5	3	0.6	0.5	0.06	40	—	28	—
NR72	72	68.2	0	-0.6	4.85	4.70	1.7	1.6	78.6	5	3	0.6	0.5	0.06	—	35	30	20
NR75	75	71.2	0	-0.6	4.85	4.70	1.7	1.6	81.6	5	3	0.6	0.5	0.06	45	—	32	—
NR80	80	76.2	0	-0.6	4.85	4.70	1.7	1.6	86.6	5	3	0.6	0.5	0.06	50	40	35	25
NR85	85	81.2	0	-0.6	4.85	4.70	1.7	1.6	91.6	5	3	0.6	0.5	0.06	—	45	—	—
NR90	90	86.2	0	-0.6	4.85	4.70	2.46	2.36	96.5	5	3	0.6	0.5	0.06	55	50	40	30
NR95	95	91.2	0	-0.6	4.85	4.70	2.46	2.36	101.6	5	3	0.6	0.5	0.06	60	—	—	—
NR100	100	96.2	0	-0.8	4.85	4.70	2.46	2.36	106.5	5	3	0.6	0.5	0.06	65	55	45	35
NR110	110	106.2	0	-0.8	4.85	4.70	2.46	2.36	116.6	5	3	0.6	0.5	0.06	70	60	50	40
NR115	115	111.2	0	-0.8	4.85	4.70	2.46	2.36	121.6	5	3	0.6	0.5	0.06	75	—	—	—
NR120	120	114.6	0	-0.8	7.21	7.06	2.82	2.72	129.7	7	4	0.6	0.5	0.06	—	65	55	45
NR125	125	119.6	0	-0.8	7.21	7.06	2.82	2.72	134.7	7	4	0.6	0.5	0.06	80	70	—	—
NR130	130	124.6	0	-0.8	7.21	7.06	2.82	2.72	139.7	7	4	0.6	0.5	0.06	85	75	60	50
NR140	140	134.6	0	-1.2	7.21	7.06	2.82	2.72	149.7	7	4	0.6	0.5	0.06	90	80	65	55
NR145	145	139.6	0	-1.2	7.21	7.06	2.82	2.72	154.7	7	4	0.6	0.5	0.06	95	—	—	—
NR150	150	144.5	0	-1.2	7.21	7.06	2.82	2.72	159.7	7	4	0.6	0.5	0.06	100	85	70	60
NR160	160	154.5	0	-1.2	7.21	7.06	2.82	2.72	169.7	7	4	0.6	0.5	0.06	105	90	75	65
NR170	170	162.9	0	-1.2	9.60	9.45	3.1	3.0	182.9	10	6	0.6	0.5	0.06	110	95	80	—
NR180	180	172.8	0	-1.2	9.60	9.45	3.1	3.0	192.9	10	6	0.6	0.5	0.06	120	100	85	70
NR190	190	182.8	0	-1.4	9.60	9.45	3.1	3.0	202.9	10	6	0.6	0.5	0.06	—	105	90	75
NR200	200	192.8	0	-1.4	9.60	9.45	3.1	3.0	212.9	10	6	0.6	0.5	0.06	130	110	95	80

● Snap Rings and Grooves for Rolling Bearings



Groove

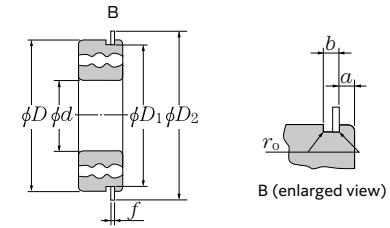

Unit: mm

Bearing outside diameter <i>D</i>	Groove diameter <i>D</i> ₁	Dimension series				Groove width		Fillet radius of groove bottom <i>r</i> ₀	
		0		2, 3, 4		<i>b</i>			
	Max.	Min.	Max.	Min.	Max.	Min.	Max.	Min.	Max.
30	28.17	27.91	—	—	2.06	1.90	1.65	1.35	0.4
32	30.15	29.90	2.06	1.90	2.06	1.90	1.65	1.35	0.4
35	33.17	32.92	2.06	1.90	2.06	1.90	1.65	1.35	0.4
37	34.77	34.52	—	—	2.06	1.90	1.65	1.35	0.4
40	38.10	37.85	—	—	2.06	1.90	1.65	1.35	0.4
42	39.75	39.50	2.06	1.90	2.06	1.90	1.65	1.35	0.4
44	41.75	41.50	2.06	1.90	—	—	1.65	1.35	0.4
47	44.60	44.35	2.06	1.90	2.46	2.31	1.65	1.35	0.4
50	47.60	47.35	—	—	2.46	2.31	1.65	1.35	0.4
52	49.73	49.48	2.06	1.90	2.46	2.31	1.65	1.35	0.4
55	52.60	52.35	2.08	1.88	—	—	1.65	1.35	0.4
56	53.60	53.35	—	—	2.46	2.31	1.65	1.35	0.4
58	55.60	55.35	2.08	1.88	2.46	2.31	1.65	1.35	0.4
62	59.61	59.11	2.08	1.88	3.28	3.07	2.2	1.9	0.6
65	62.60	62.10	—	—	3.28	3.07	2.2	1.9	0.6
68	64.82	64.31	2.49	2.29	3.28	3.07	2.2	1.9	0.6
72	68.81	68.30	—	—	3.28	3.07	2.2	1.9	0.6
75	71.83	71.32	2.49	2.29	3.28	3.07	2.2	1.9	0.6
80	76.81	76.30	2.49	2.29	3.28	3.07	2.2	1.9	0.6
85	81.81	81.31	—	—	3.28	3.07	2.2	1.9	0.6
90	86.79	86.28	2.87	2.67	3.28	3.07	3.0	2.7	0.6
95	91.82	91.31	2.87	2.67	—	—	3.0	2.7	0.6
100	96.80	96.29	2.87	2.67	3.28	3.07	3.0	2.7	0.6
110	106.81	106.30	2.87	2.67	3.28	3.07	3.0	2.7	0.6
115	111.81	111.30	2.87	2.67	—	—	3.0	2.7	0.6
120	115.21	114.71	—	—	4.06	3.86	3.4	3.1	0.6
125	120.22	119.71	2.87	2.67	4.06	3.86	3.4	3.1	0.6
130	125.22	124.71	2.87	2.67	4.06	3.86	3.4	3.1	0.6
140	135.23	134.72	3.71	3.45	4.90	4.65	3.4	3.1	0.6
145	140.23	139.73	3.71	3.45	—	—	3.4	3.1	0.6
150	145.24	144.73	3.71	3.45	4.90	4.65	3.4	3.1	0.6
160	155.22	154.71	3.71	3.45	4.90	4.65	3.4	3.1	0.6
170	163.65	163.14	3.71	3.45	5.69	5.44	3.8	3.5	0.6
180	173.66	173.15	3.71	3.45	5.69	5.44	3.8	3.5	0.6
190	183.64	183.13	—	—	5.69	5.44	3.8	3.5	0.6
200	193.65	193.14	5.69	5.44	5.69	5.44	3.8	3.5	0.6

1) The snap ring must be fitted inside the groove in the radius direction free from looseness.

The **NTN** steel balls conform to JIS B 1501 (steel ball for ball bearings). Contact **NTN** Engineering for any request.

High-carbon chromium bearing steel is generally used for the material. Some special types use stainless steel and heat-resistant steel.

The accuracy conforms to the JIS (JIS B 1501). Please consult **NTN** Engineering for details.

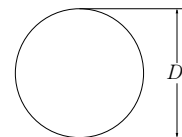

1. Ball dimensions

Nominal dimension		Nominal diameter <i>D_w</i> mm	Mass kg (approx.) 10 000 pieces
Metric	Inch		
0.3mm		0.300 00	0.0011
0.4mm		0.400 00	0.0026
0.5mm		0.500 00	0.0051
0.6mm		0.600 00	0.0089
	0.025	0.635 00	0.0105
0.7mm		0.700 00	0.0141
	1/32	0.793 75	0.0205
0.8mm		0.800 00	0.0210
1mm		1.000 00	0.0410
	3/64	1.190 62	0.0692
1.2mm		1.200 00	0.0708
1.5mm		1.500 00	0.1384
	1/16	1.587 50	0.1640
	5/64	1.984 38	0.3204
2mm		2.000 00	0.3280
	3/32	2.381 25	0.5536
2.5mm		2.500 00	0.6406
	7/64	2.778 12	0.8790
2.8mm		2.800 00	0.9000
3mm		3.000 00	1.107
	1/8	3.175 00	1.312
3.5mm		3.500 00	1.758
	9/64	3.571 88	1.868
	5/32	3.968 75	2.563
4mm		4.000 00	2.624
4.5mm		4.500 00	3.736
	3/16	4.762 50	4.429
5mm		5.000 00	5.125
5.5mm		5.500 00	6.821
	7/32	5.556 25	7.032
	15/64	5.953 12	8.650
6mm		6.000 00	8.856
	1/4	6.350 00	10.50
6.5mm		6.500 00	11.26
	17/64	6.746 88	12.59
7mm		7.000 00	14.06
	9/32	7.143 75	14.95
7.5mm		7.500 00	17.30
	5/16	7.937 50	20.50
8mm		8.000 00	20.99
8.5mm		8.500 00	25.18
	11/32	8.731 25	27.29
9mm		9.000 00	29.89

Nominal dimension		Nominal diameter <i>D_w</i> mm	Mass kg (approx.) 1 000 pieces
Metric	Inch		
	3/8	9.525 00	3.543
10mm		10.000 00	4.100
	13/32	10.318 75	4.504
11mm		11.000 00	5.457
	7/16	11.112 50	5.626
11.5mm		11.500 00	6.235
	15/32	11.906 25	6.920
12mm		12.000 00	7.084
	1/2	12.700 00	8.398
13mm		13.000 00	9.007
	17/32	13.493 75	10.07
14mm		14.000 00	11.25
	9/16	14.287 50	11.96
15mm		15.000 00	13.84
	19/32	15.081 25	14.06
	5/8	15.875 00	16.40
16mm		16.000 00	16.79
	21/32	16.668 75	18.99
17mm		17.000 00	20.14
	11/16	17.462 50	21.83
18mm		18.000 00	23.91
	23/32	18.256 25	24.95
19mm		19.000 00	28.12
	3/4	19.050 00	28.34
	25/32	19.843 75	32.04
20mm		20.000 00	32.80
	13/16	20.637 50	36.04
21mm		21.000 00	37.97
	27/32	21.431 25	40.36
22mm		22.000 00	43.65
	7/8	22.225 00	45.01
23mm		23.000 00	49.88
	29/32	23.018 75	50.00
	15/16	23.812 50	55.36
24mm		24.000 00	56.68
	31/32	24.606 25	61.08
25mm		25.000 00	64.06
	1	25.400 00	67.18
26mm		26.000 00	72.06
	1 1/16	26.987 50	80.58
28mm		28.000 00	90.00
	1 1/8	28.575 00	95.66

Nominal dimension		Nominal diameter <i>D_w</i> mm	Mass kg (approx.) 10 pieces
Metric	Inch		
30mm		30.000 00	1.107
	1 3/16	30.162 50	1.125
	1 1/4	31.750 00	1.312
32mm		32.000 00	1.343
	1 5/16	33.337 50	1.519
34mm		34.000 00	1.611
	1 3/8	34.925 00	1.747
35mm		35.000 00	1.758
36mm		36.000 00	1.913
	1 7/16	36.512 50	1.996
38mm		38.000 00	2.250
	1 1/2	38.100 00	2.267
	1 9/16	39.687 50	2.563
40mm		40.000 00	2.624
	1 5/8	41.275 00	2.883
	1 11/16	42.862 50	3.228
	1 3/4	44.450 00	3.601
45mm		45.000 00	3.736
	1 13/16	46.037 50	4.000
	1 7/8	47.625 00	4.429
	1 15/16	49.212 50	4.886
50mm		50.000 00	5.125
	2	50.800 00	5.375
	2 1/8	53.975 00	6.447
55mm		55.000 00	6.821
	2 1/4	57.150 00	7.653
60mm		60.000 00	8.856
	2 3/8	60.325 00	9.000
	2 1/2	63.500 00	10.50
65mm		65.000 00	11.26
	2 5/8	66.675 00	12.15
	2 3/4	69.850 00	13.97
	2 7/8	73.025 00	15.97
	3	76.200 00	18.14
	3 1/4	82.550 00	23.06
	3 1/2	88.900 00	28.80
	3 3/4	95.250 00	35.43
	4	101.600 00	43.00
	4 1/4	107.950 00	51.57
	4 1/2	114.300 00	61.22

2. Applicable range of class, accuracy of shapes and surface roughness, accuracy and gauges of classification

Unit: μm

Class	Accuracy and surface roughness of shapes ¹⁾			Accuracy and gauges of classification								
	Diameter variation (Max.)	Sphericity (Max.)	Surface roughness R_a (Max.)	Mutual tolerance of lot diameter (Max.)	Gauge interval	Gauge						
G3	0.08	0.08	0.010	0.13	0.5	-5,,	-0.5,	0,	+0.5,,	+5
G5	0.13	0.13	0.014	0.25	1	-5,,	-1,	0,	+1,,	+5
G10	0.25	0.25	0.020	0.5	1	-9,,	-1,	0,	+1,,	+9
G16	0.4	0.4	0.025	0.8	2	-10,,	-2,	0,	+2,,	+10
G20	0.5	0.5	0.032	1	2	-10,,	-2,	0,	+2,,	+10
G24	0.6	0.6	0.040	1.2	2	-12,,	-2,	0,	+2,,	+12
G28	0.7	0.7	0.050	1.4	2	-12,,	-2,	0,	+2,,	+12
G40	1	1	0.060	2	4	-16,,	-4,	0,	+4,,	+16
G60	1.5	1.5	0.080	3	6	-18,,	-6,	0,	+6,,	+18
G100	2.5	2.5	0.100	5	10	-40,,	-10,	0,	+10,,	+40
G200	5	5	0.150	10	15	-60,,	-15,	0,	+15,,	+60

1) Measure the dimension excluding the flaws because the values do not incorporate flaws on the surface.

3. Hardness

Nominal dimension	Hardness	
	HV	HRC
0.3mm to 3mm	772 to 900	(63 to 67) ²⁾
1/8 to 30mm	—	62 to 67
1 3/16 to 4	—	61 to 67

2) The value in () is shown by reference to the converted value.

High-carbon chromium bearing steel is used for needle rollers. The needle rollers are ground and polished after heat treatment. The surface hardness is 60 to 65 HRC.

Needle rollers are provided as rolling elements or pins for operation directly on the shaft.

1. Shape of needle rollers

The standard shape of needle rollers has a flat surface on its end face (referred to as F type). Crowned contact surfaces are also available (suffix code: E) and can reduce the edge load on the rollers. Excessive edge load on rollers can result in premature failure. Contact NTN Engineering for more information.

Table 1 End face shape

Type	Designation	Shape
F	Flat surface	

2. Needle roller part number composition

The needle roller part number is composed of a model code (end face type), a dimension code [diameter (D_w) x length (L_w)], and a suffix code (Refer to Fig. 1).

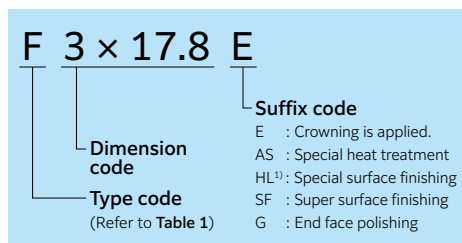

Fig. 1

1) For HL, contact NTN Engineering.

3. Accuracy of needle rollers

The dimensional accuracy of needle rollers is maintained in accordance with JIS B 1506 (Rolling bearings—Rollers). (Refer to Table 2)

Table 2 Accuracy of needle rollers Unit: μm

Characteristics	Tolerance and tolerance values
Tolerance of average value of diameter D_w	0 to -10
Mutual tolerance of lot diameter D_w (max.)	2
Roundness of diameter D_w , diameter variation in flat surface	1.0 ($L_w/D_w \leq 6$) 1.5 ($L_w/D_w > 6$)
Tolerance of length L_w	h13
Accuracy class	Class 2

Needle rollers are separated into groupings of $2\mu\text{m}$ ranges based on the diameter of the roller and are separately packaged to maintain consistency between supplied rollers. Depending on the tolerance range, the needle rollers are classified by label colors such as red, black, and blue, and then delivered.

Bearing rollers in packages having different label colors must not be mixed.

Table 3 Diameter dimensional tolerance and classification of needle rollers

Label color	Tolerance range (μm)	Classification
Red	0 to -2	Standard
Navy	-1 to -3	
Blue	-2 to -4	
Black	-3 to -5	
White	-4 to -6	
Gray	-5 to -7	Sub standard
Green	-6 to -8	
Brown	-7 to -9	
Yellow	-8 to -10	

4. Application of needle rollers

When a full complement needle roller bearing is made with a standard needle roller, the shaft diameter (d), the housing bore diameter (D), the circumferential clearance (ΔC), and the radial internal clearance (Δr) are calculated from the needle roller diameter (D_w) and the number of rollers (Z) (see Fig. 2).

The minimum value of the circumferential clearance (ΔC) is calculated by Equation (1). The radial internal clearance (Δr) is selected based on the shaft diameter and the usage conditions using section "E. Needle roller bearings 2.4 Solid type needle roller bearings Table 9 (E-7)" as guidance. Full complement needle roller bearings generally require a larger radial inner clearance than a needle roller bearing with cage.

$$\Delta C = (0.005 \sim 0.020) \times Z \text{ mm} \text{ (minimum value) } \dots \dots \dots (1)$$

The minimum value of the housing bore diameter (D) and the maximum value of the shaft diameter (d) are calculated from Equations (2) and (3).

$$D = \frac{1}{\sin\left(\frac{\pi}{Z}\right)} \cdot \left(D_w + \frac{\Delta C}{Z}\right) + D_w \text{ mm} \text{ (minimum value) } \dots \dots \dots (2)$$

$$d = D - 2D_w - \Delta r \text{ mm} \text{ (maximum value) } \dots \dots \dots (3)$$

In order to retain the needle rollers in the housing using the keystone method, the maximum value of the housing bore diameter (D) is calculated from the minimum value of the roller diameter ($D_{w \text{ min}}$) and the number of rollers (Z) using Equation (4) (see Fig. 3). Factor K is shown in Table 4.

$$D = K \cdot D_{w \text{ min}} \text{ mm (maximum value) } \dots \dots (4)$$

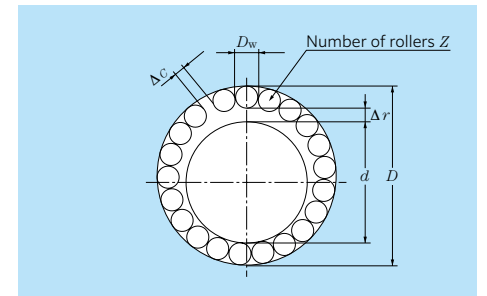

Fig. 2

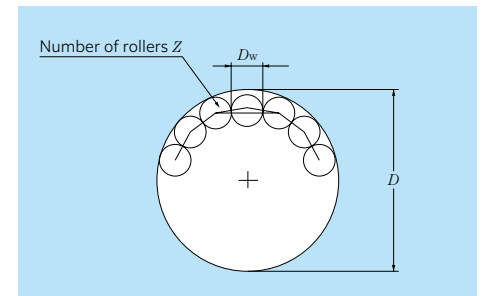
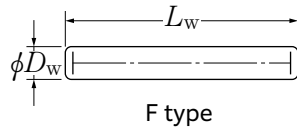

Fig. 3

Table 4 Values of factor K

Z	K	Z	K
8	3.6763333	17	6.4536463
9	3.9709394	18	6.7689303
10	4.2727719	19	7.0846088
11	4.5789545	20	7.4006100
12	4.8879667	21	7.7168786
13	5.1989251	22	8.0333713
14	5.5112799	23	8.3500534
15	5.8246707	24	8.6668970
16	6.1388508	25	8.9838796

F type



d 1.5 ~ 4.5mm

Boundary dimensions mm	Number	Mass kg (approx.) 1 000 pieces
1.5	F1.5 × 5.8	0.080
	F1.5 × 6.8	0.090
	F1.5 × 7.8	0.104
	F1.5 × 9.8	0.131
	F1.5 × 11.8	0.159
	F1.5 × 13.8	0.186
2	F2 × 6.8	0.158
	F2 × 7.8	0.183
	F2 × 9.8	0.232
	F2 × 11.8	0.281
	F2 × 13.8	0.330
	F2 × 15.8	0.379
	F2 × 17.8	0.428
F2 × 19.8	0.477	
2.5	F2.5 × 7.8	0.284
	F2.5 × 9.8	0.351
	F2.5 × 11.8	0.438
	F2.5 × 13.8	0.514
	F2.5 × 15.8	0.591
	F2.5 × 17.8	0.668
	F2.5 × 19.8	0.745
	F2.5 × 21.8	0.821
F2.5 × 23.8	0.898	
3	F3 × 9.8	0.556
	F3 × 11.8	0.671
	F3 × 13.8	0.784
	F3 × 15.8	0.897
	F3 × 17.8	1.01
	F3 × 19.8	1.12
	F3 × 21.8	1.23
	F3 × 23.8	1.34
	F3 × 25.8	1.45
	F3 × 27.8	1.56

Boundary dimensions mm	Number	Mass kg (approx.) 1 000 pieces
3.5	F3.5 × 11.8	0.849
	F3.5 × 13.8	1.00
	F3.5 × 15.8	1.15
	F3.5 × 17.8	1.30
	F3.5 × 19.8	1.45
	F3.5 × 21.8	1.60
	F3.5 × 23.8	1.75
	F3.5 × 25.8	1.90
	F3.5 × 29.8	2.20
	F3.5 × 31.8	2.35
	F3.5 × 34.8	2.58
4	F4 × 13.8	1.27
	F4 × 15.8	1.50
	F4 × 17.8	1.70
	F4 × 19.8	1.89
	F4 × 21.8	2.09
	F4 × 23.8	2.26
	F4 × 25.8	2.48
	F4 × 27.8	2.68
	F4 × 29.8	2.87
	F4 × 31.8	3.07
	F4 × 34.8	3.31
4.5	F4.5 × 17.8	2.11
	F4.5 × 19.8	2.36
	F4.5 × 21.8	2.61
	F4.5 × 23.8	2.86
	F4.5 × 25.8	3.11
	F4.5 × 29.8	3.62
	F4.5 × 31.8	3.87
	F4.5 × 34.8	4.25
	F4.5 × 37.8	4.63
	F4.5 × 39.8	4.88
	F4.5 × 44.8	5.51

d 5mm

Boundary dimensions mm	Number	Mass kg (approx.) 1 000 pieces
5	F5 × 19.8	2.89
	F5 × 21.8	3.20
	F5 × 23.8	3.52
	F5 × 25.8	3.82
	F5 × 29.8	4.45
	F5 × 31.8	4.74
	F5 × 34.8	5.11
	F5 × 37.8	5.55
	F5 × 39.8	5.85
	F5 × 49.8	7.33

Needle Roller Bearings



Needle Roller Bearings Contents

Needle roller bearings	E- 2
Needle roller and cage assemblies	E-12
Drawn cup needle roller bearings	E-26
Machined-ring needle roller bearings	E-34
Thrust cylindrical roller bearings	E-56
Thrust needle roller bearings	E-62
Cam follower stud type track rollers	E-66
Roller follower yoke type track rollers	E-84

2.2 Needle roller bearing with cage

These needle roller bearings include needle rollers and cages that guide and hold the needle rollers. The structure is lightweight and compact because no inner ring or outer ring is used and the shaft and the housing are used as raceway surfaces.

Table 4 shows recommended fits for this bearing type, and Table 5 shows the diameter dimensional tolerance and classification of needle rollers. See section 2.1 for the accuracy and surface hardness necessary for shafts and housings serving as the raceway surfaces for these bearings.

The needle roller diameter variation included in a single assembly is within $2 \mu\text{m}$, and the standard classification shown in Table 5 will be supplied if there is no particular designation. When two or more of the same bearings are to be used in tandem arrangement, it is necessary to use bearings having rollers of the same classification promote equal load sharing.

For caged needle roller bearings that are used for the connecting rod of small/medium reciprocating engines, see the catalog "Needle roller bearings (CAT. No. 2300/E)."

Table 4 Fits recommended for needle roller bearings with cage

Shaft diameter mm	Recommended fits					
	Internal clearance less than normal		Normal clearance		Internal clearance greater than normal	
	Shaft	Housing	Shaft	Housing	Shaft	Housing
Up to 80	j5	G6	h5	G6	g6	G6
80 to 140	h5	G6	g5	G6	f6	G6
140 or more	h5	G6	f5	H6	f6	G6

Table 5 Diameter dimensional tolerance and classification of needle rollers

Label color	Tolerance range (μm)	Classification
Red	-0 to - 2	Standard
Navy	-1 to - 3	
Blue	-2 to - 4	
Black	-3 to - 5	
White	-4 to - 6	
Gray	-5 to - 7	Sub standard
Green	-6 to - 8	
Brown	-7 to - 9	
Yellow	-8 to -10	

When a caged needle roller bearing is used as a single body to be directly guided in the axial direction by a shaft shoulder (Fig. 2), any part coming into contact with the cage side surface must be sufficiently finished without burrs. For high speed or heavy load operation, the contact surface is hardened and finished by grinding.

When a cage is to be guided in the axial direction with a snap ring (Fig. 2), a thrust ring is used between the cage and the snap ring so that the snap ring lugs do not come in contact with the cage directly.

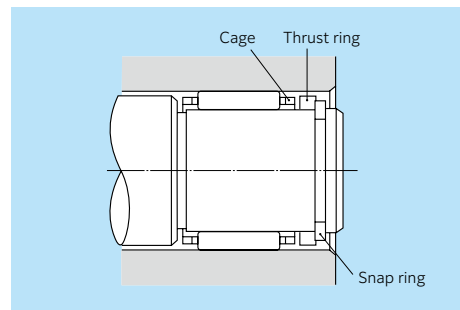

Fig. 2 Fixing using thrust ring

2.3 Drawn cup needle roller bearings

The outer ring of drawn cup needle roller bearings is formed by precision drawing from a thin steel plate, and is designed to have an appropriate accuracy for its intended function when press-fit into a rigid housing.

Therefore, it is meaningless to measure the dimensional accuracy of the bearing itself before press fitting. After pressing into a ring gauge (with wall thickness of 20 mm or more) having appropriate dimensions, the bearing accuracy is evaluated by measuring the roller inscribed circle diameter (F_w) with a plug gauge or a tapered gauge.

Recommended fits for drawn cup needle roller bearings are shown in Table 6, and recommended shaft and housing accuracy is shown in Table 7. Tables 8.1 and 8.2 show the dimensional tolerances of the ring gauge inner diameter dimension and the roller inscribed circle diameter (F_w) with respect to the standard metric series HK and BK types and the heavy load series HMK type.

Table 6 Drawn cup needle roller bearing housing and shaft fits

Bearing type	Housing		Shaft	
	Iron-based	Light alloy	No inner ring	With an inner ring
HK, BK	N6(N7)	R6(R7)	h5(h6)	k5(j6)
HMK	J6(J7)	M6(M7)		

Table 7 Recommended shaft and housing accuracy

Characteristics	Shaft	Housing
Dimensional accuracy	IT6 (IT5)	IT7 (IT6)
Roundness Cylindricity (Max.)	IT3	IT4
Abutment squareness (Max.)	IT3	IT3
Fitting surface roughness R_a	0.8	1.6

Note: Accuracy in () applies to bearings of accuracy class 5 and higher.

When a plug gauge is used for the measurement of the roller inscribed circle diameter (F_w), the dimension of the go side is the lower limit of the dimensional tolerance of the roller inscribed circle diameter, and the dimension of the no-go side is the value obtained by adding $2 \mu\text{m}$ to the upper limit of the dimensional tolerance of the roller inscribed circle diameter.

Since the outer ring is formed by a thin steel plate, the safety factor (S_0) when the bearing is used must be $S_0 \geq 3$ for standard specifications, and $S_0 \geq 2$ must be maintained for the carburized/quenched specification (premium shell bearing¹⁾).

1) Premium shell bearings

For details, see the special catalog issued separately "Premium shell bearings (CAT. No. 3029/JE)." (Suffix code F is added to the bearing number.)

Table 8.1 Accuracy of drawn cup needle roller bearings (1)

Dimensional tolerance of roller inscribed circle diameter (HK and BK types) Unit: mm

Nominal roller inscribed circle diameter F_w	Nominal outer ring outer diameter D	Ring gauge inner diameter	Dimensional tolerance of roller inscribed circle diameter	
			Upper limit	Lower limit
3	6.5	6.484	3.016	3.006
4	8	7.984	4.022	4.010
5	9	8.984	5.022	5.010
6	10	9.984	6.022	6.010
7	11	10.980	7.028	7.013
8	12	11.980	8.028	8.013
9	13	12.980	9.028	9.013
10	14	13.980	10.028	10.013
12	16	15.980	12.034	12.016
12	18	17.980	12.034	12.016
13	19	18.976	13.034	13.016
14	20	19.976	14.034	14.016
15	21	20.976	15.034	15.016
16	22	21.976	16.034	16.016
17	23	22.976	17.034	17.016
18	24	23.976	18.034	18.016
20	26	25.976	20.041	20.020
22	28	27.976	22.041	22.020
25	32	31.972	25.041	25.020
28	35	34.972	28.041	28.020
30	37	36.972	30.041	30.020
35	42	41.972	35.050	35.025
40	47	46.972	40.050	40.025
45	52	51.967	45.050	45.025
50	58	57.967	50.050	50.025

Table 8.2 Accuracy of drawn cup needle roller bearings (2)

Dimensional tolerance of roller inscribed circle diameter (HMK type) Unit: mm

Nominal roller inscribed circle diameter F_w	Nominal outer ring outer diameter D	Ring gauge inner diameter	Dimensional tolerance of roller inscribed circle diameter	
			Upper limit	Lower limit
8	15	14.995	8.028	8.013
9	16	15.995	9.028	9.013
10	17	16.995	10.028	10.013
12	19	18.995	12.034	12.016
14	22	21.995	14.034	14.016
15	22	21.995	15.034	15.016
16	24	23.995	16.034	16.016
17	24	23.995	17.034	17.016
18	25	24.995	18.034	18.016
19	27	26.995	19.041	19.020
20	27	26.995	20.041	20.020
21	29	28.995	21.041	21.020
22	29	28.995	22.041	22.020
24	31	30.994	24.041	24.020
25	33	32.994	25.041	25.020
26	34	33.994	26.041	26.020
28	37	36.994	28.041	28.020
29	38	37.994	29.041	29.020
30	40	39.994	30.041	30.020
32	42	41.994	32.050	32.025
35	45	44.994	35.050	35.025
37	47	46.994	37.050	37.025
38	48	47.994	38.050	38.025
40	50	49.994	40.050	40.025
45	55	54.994	45.050	45.025
50	62	61.994	50.050	50.025

When a drawn cup needle roller bearing is to be inserted into a housing, the marked side of the bearing must be press-fit into the appropriate position with the use of a jig.

(There is no designation for the installation direction of pre-bent specification products¹⁾.)

The bearings must not be directly struck by a hammer when being installed. Use an installation jig like that shown in Fig. 3, having a mandrel equipped with an O-ring for ease of installation, should be used to ensure the bearing will not fall off or become damaged during installation.

When inserting an inner ring or a shaft into a drawn cup needle roller bearing installed in a housing, insert it straightly by aligning the central axis of the inner ring or the shaft with the central axis of the housing.

Since a drawn cup needle roller bearing is positioned by means of the housing, it is unnecessary to provide a snap ring or a shoulder. However, when a drawn cup needle roller bearing is to be press-fitted into a housing having a shoulder, it is necessary to pay attention to prevent the bearing side surface from contacting the shoulder, thereby causing deformation of the bearing.

1) Pre-bent specification

The outer ring flange is hardened on both sides by heat treating the outer ring after inserting the cage and rollers and bending the edge of the ring. Thus, bearings can be press-fitted from any direction compared with conventional products, which required applying a jig on the outer ring marking side. (Suffix code M is added to the bearing number.)

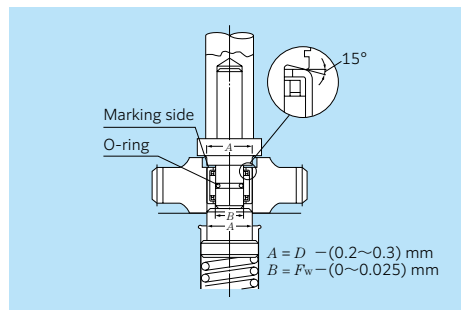

Fig. 3

2.4 Solid type needle roller bearings

These bearings have a non-separable construction held together by flanges or side plates on both sides of the outer ring, with needle rollers and cages contained within a solid (machined) outer ring. Since the outer ring is solid (machined), it has high rigidity and the bearing accuracy can be increased; therefore, the bearings are suitable for applications that require high speed, high load, and high rotational accuracy.

There are two types of solid type needle roller bearings: one having an inner ring and one having no inner ring. Bearings without an inner ring use the shaft directly as a raceway surface, and the required dimensional tolerance of the shaft diameter (raceway diameter) is as shown in Table 9 based on required operating clearance (see Table 1 required accuracy of other parameters). The corresponding dimensional tolerance of the housing bore is set to K7, which is widely used in general. Please consult NTN Engineering when setting the dimensional tolerance of the housing bore to other classes.

Table 9 Dimensional tolerance for shaft (raceway diameter)

Roller inscribed circle diameter F_w mm		Shaft tolerance class		
		Internal clearance less than normal	Normal clearance	Internal clearance greater than normal
Over	Incl.			
80	160	k5	h5	f6
160	180	k5	g5	f6
180	200	j5	g5	e6
200	250	j5	f6	e6
250	315	h5	f6	e6
315	400	g5	f6	d6

Tables 10.1 and 10.2 show values of the radial internal clearance of bearings with an inner ring. Table 10.1 shows the clearance of interchangeable bearings, and the clearance values are satisfied even if the inner rings and outer rings are intermixed. Table 10.2 shows the clearance of non-interchangeable bearings, and the clearance range is tightly controlled. Therefore, the inner rings and outer rings cannot be intermixed. The clearance codes are C2, normal, C3, and C4 from smallest to largest, and suffix code NA is added for the non-interchangeable clearance.

Table 10.1 Radial internal clearance of solid type needle roller bearings (1) interchangeable bearings Unit: μm

Nominal bearing bore diameter d (mm)		Radial internal clearance							
		C2		Normal ¹⁾		C3		C4	
Over	Incl.	Min.	Max.	Min.	Max.	Min.	Max.	Min.	Max.
—	10	0	30	10	40	25	55	35	65
10	18	0	30	10	40	25	55	35	65
18	24	0	30	10	40	25	55	35	65
24	30	0	30	10	45	30	65	40	70
30	40	0	35	15	50	35	70	45	80
40	50	5	40	20	55	40	75	55	90
50	65	5	45	20	65	45	90	65	105
65	80	5	55	25	75	55	105	75	125
80	100	10	60	30	80	65	115	90	140
100	120	10	65	35	90	80	135	105	160
120	140	10	75	40	105	90	155	115	180
140	160	15	80	50	115	100	165	130	195
160	180	20	85	60	125	110	175	150	215
180	200	25	95	65	135	125	195	165	235
200	225	30	105	75	150	140	215	180	255
225	250	40	115	90	165	155	230	205	280
250	280	45	125	100	180	175	255	230	310
280	315	50	135	110	195	195	280	255	340
315	355	55	145	125	215	215	305	280	370
355	400	65	160	140	235	245	340	320	415
400	450	70	190	155	275	270	390	355	465

1) No clearance code is given to this type of bearings.

Table 10.2 Radial internal clearance of solid type needle roller bearings (2) non-interchangeable bearings Unit: μm

Nominal bearing bore diameter d (mm)		Radial internal clearance							
		C2NA		Normal ¹⁾		C3NA		C4NA	
Over	Incl.	Min.	Max.	Min.	Max.	Min.	Max.	Min.	Max.
—	10	10	20	20	30	35	45	45	55
10	18	10	20	20	30	35	45	45	55
18	24	10	20	20	30	35	45	45	55
24	30	10	25	25	35	40	50	50	60
30	40	12	25	25	40	45	55	55	70
40	50	15	30	30	45	50	65	65	80
50	65	15	35	35	50	55	75	75	90
65	80	20	40	40	60	70	90	90	110
80	100	25	45	45	70	80	105	105	125
100	120	25	50	50	80	95	120	120	145
120	140	30	60	60	90	105	135	135	160
140	160	35	65	65	100	115	150	150	180
160	180	35	75	75	110	125	165	165	200
180	200	40	80	80	120	140	180	180	220
200	225	45	90	90	135	155	200	200	240
225	250	50	100	100	150	170	215	215	265
250	280	55	110	110	165	185	240	240	295
280	315	60	120	120	180	205	265	265	325
315	355	65	135	135	200	225	295	295	360
355	400	75	150	150	225	255	330	330	405
400	450	85	170	170	255	285	370	370	455

1) Only code "NA" is given to this type of bearings. Example: NA4920NA

When there is an oil hole on the raceway surface, bearings should be installed such that the oil hole position is located in the non-loaded region. A bearing with an inner ring must be used within the allowable movement amount (s) (a state in which the rollers are within the range of the inner ring effective contact length). The allowable movement amount (s) is illustrated in Fig. 4, values are listed in the bearing dimension tables.

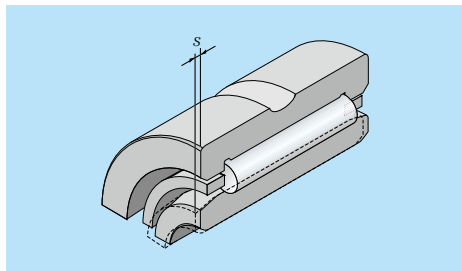

Fig. 4 Allowable movement amount (s)

2.5 Thrust roller bearing

Thrust roller bearings are bearings having a disc-shaped raceway combined with a cage-and-roller assembly having needle rollers or cylindrical rollers radially embedded, and are suitable for axial loads applied in a single direction.

Further, a shaft or housing can be directly used as a raceway surface without using a separate raceway ring. Thereby, size in the axial direction can be minimized, and lightweight and compact designs can be obtained. Table 11 shows fits recommended for thrust roller bearings. See Table 1 for the required accuracy of the raceway surface.

Table 11 Fits recommended for thrust roller bearings

Bearing parts		Type and class	
		Shaft diameter	Housing bore
AXK type, K811 type	Inner diameter guide	h8 ¹⁾	—
	Outer diameter guide	—	H9 ¹⁾
WS type raceway (inner ring)		h6	—
GS type raceway (outer ring)		—	H7
Steel raceway AS type	Shaft fixing	h10	Clearance with housing
	Housing fixing	Clearance with shaft	Loose H11

1) The guide surface is finished by grinding.

2.6 Cam follower/roller follower

A cam follower is a track roller having a stud in place of an inner ring, and the outer ring rolls on a track. It is a bearing used as an eccentric roller, a guide roller, etc., and it can have a cylindrical shape or a spherical shape for the outer ring outer diameter. Cam follower bearings are offered in both cage type and full complement designs.

When attaching a cam follower **do not strike the flange part with a hammer because sharp impact may cause cracks and rotational failure (Fig. 5)**. In addition, the oil supply hole position on the stud raceway surface of the cam follower is indicated by the NTN mark on the stud flange surface. **Install it by rotating the nut while the fixing the nut so that the mark (oil hole) is positioned in the non-loaded region (Fig. 6)**. The thread part may break if too much tightening torque is applied.

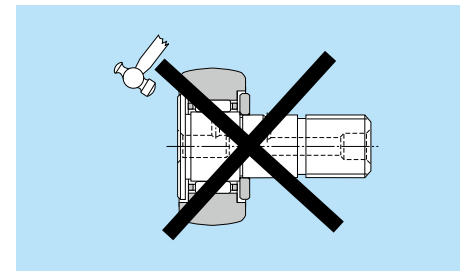

Fig. 5

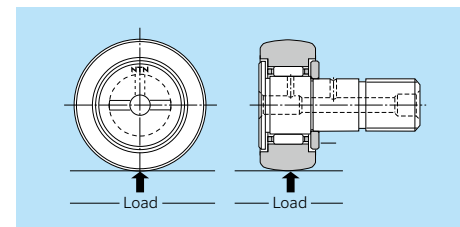

Fig. 6

A roller follower is a bearing in which the outer ring rolls on a track. As with the cam follower, there is a cylindrical shape or a spherical shape for the outer ring outer diameter, and are offered in both cage type and full complement designs. Common uses include use as an eccentric roller, guide roller, rocker arm roller, cam roller, pressure roller, etc.

A roller follower must be installed so that the oil hole is positioned in the non-loaded region because installing the oil hole position of the inner ring in the loaded region may shorten the bearing life.

Table 12 shows the radial internal clearance of cam followers and roller followers, Tables 13 and 14 show the dimensional accuracy and recommended fits of cam followers, and Table 15 shows the recommended fits of roller followers.

Table 12 Radial internal clearance of cam followers and roller followers

Nominal roller inscribed circle diameter F_w mm	Over	Incl.	Internal clearance μm							
			C2		CN (normal)		C3		C4	
			Min.	Max.	Min.	Max.	Min.	Max.	Min.	Max.
3	6	0	10	3	17	15	30	20	40	
6	10	0	12	5	20	15	30	25	45	
10	18	0	15	5	25	15	35	30	55	
18	30	0	20	10	30	20	40	40	65	
30	50	0	25	10	40	25	55	50	80	
50	80	0	30	15	50	30	65	60	100	
80	100	0	35	20	55	35	75	70	115	

Table 13 Dimensional accuracy of cam followers

Bearing	Outer ring shape	Stud diameter	Outer ring outer diameter	Outer ring width	
				Min.	Max.
Milli series	Spherical surface	h7	0	0	JIS Class 0
	Cylindrical surface			-50	
Inch series	Spherical surface	+25	0	0	-130
	Cylindrical surface			0	

Unit: μm

Table 14 Fits recommended for cam followers

Bearing	Type and class of mounting hole
Metric series	H7
Inch series	F7

Note: Assembly must be done without backlash for impact loads.

Table 15 Fits recommended for roller followers

Type and class of shaft	
No inner ring	With an inner ring
k5 or k6	g6 or h6

The maximum radial load that can be statically permitted on the contact surface between the track and the track roller is referred to as the track load capacity, and the value differs depending on the hardness of the track. The track load capacity specified in the dimension table is a value considering a track hardness of 40 HRC, and the load capacity of tracks having different hardness may be obtained by multiplying the track load capacity in the dimension table by the correction coefficient G in **Table 16**. However, when the calculated track load capacity exceeds the basic static rating load C_{0r} of the bearing, the track load capacity is equal to the basic static rating load C_{0r} of the bearing.

Table 16 Correction coefficient G

Hardness (HRC)	Correction coefficient G	
	Cylindrical shape	Spherical shape
20	0.368	0.223
25	0.459	0.311
30	0.583	0.446
35	0.750	0.650
40	1.000	1.000
45	1.414	1.681
50	1.987	2.800
55	2.787	4.652

Since **NTN** cam followers and roller followers are generally installed with cantilever loading, a non-uniform load (one-sided load) may act on the bearing due to the influence of loosening of the fitting caused by continuous use. For stable operation of equipment, it is necessary to pay sufficient attention to the looseness of the fitting.

Further, lubrication is also necessary between the outer ring outer diameter surface and the track of the bearing. Even after lubrication, the bearing and the track may be damaged at an early stage when slippage occurs between the outer ring outer diameter surface and the track of the bearing due to rapid radial load fluctuation or rotational speed fluctuation during use.

For details, see the special catalog "**Needle roller bearings (CAT. No. 2300/E)**" or "**Cam follower & roller follower (CAT. No. 3604/JE)**."

Needle roller and cage assemblies

- K type
- K·T2 type
- K·S type
- K·ZW type
- KMJ·S type
- KV·S type

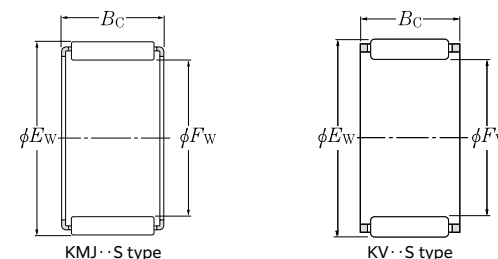
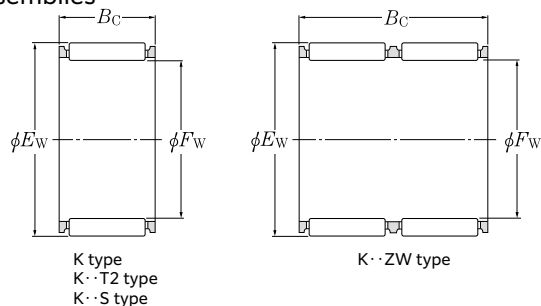

F_w 3 ~ 10mm

Boundary dimensions	Basic load rating		Fatigue load limit N C_u	Allowable speed		Number	Mass kg (approx.)
	mm			min ⁻¹			
	F_w	E_w		Grease lubrication	Oil lubrication		
3	6	7 ^{-0.2/-0.55}	1 460	970	118	33 000 50 000	K3×6×7T2T 0.0004
	4	6	8 ^{-0.2/-0.55}	1 560	1 330	162	30 000 45 000
		7	7 ^{-0.2/-0.55}	1 770	1 270	155	30 000 45 000
5	8	8 ^{-0.2/-0.55}	2 640	2 190	267	27 000 40 000	K5×8×8T2 0.0007
		8	10 ^{-0.2/-0.55}	2 720	2 250	275	27 000 40 000
6	9	8	2 660	2 280	278	25 000 37 000	K6×9×8T2T 0.0009
	9	10 ^{-0.2/-0.55}	3 400	3 150	380	25 000 37 000	K6×9×10T2T 0.0011
	10	13	4 400	3 700	455	25 000 37 000	K6×10×13T2 0.0019
7	10	8	2 670	2 350	286	23 000 34 000	K7×10×8T2 0.0009
	10	10 ^{-0.2/-0.55}	3 400	3 200	390	23 000 34 000	K7×10×10T2 0.0011
	10	13	5 050	5 400	655	23 000 34 000	KV7×10×12.8X3S 0.0023
8	11	8	3 150	3 000	365	21 000 32 000	K8×11×8T2T 0.0011
	11	9	3 150	3 000	365	21 000 32 000	8E-KV8×11×8.8X2S 0.0019
	11	10	4 000	4 100	500	21 000 32 000	K8×11×10T2 0.0013
	11	12 ^{-0.2/-0.55}	4 450	4 650	570	21 000 32 000	8E-KV8×11×11.8X2S 0.0025
	11	13 ^{-0.2/-0.55}	4 850	5 200	635	21 000 32 000	K8×11×13 0.0026
	12	10	4 650	4 150	510	21 000 32 000	K8×12×10T2 0.0020
	12	12	5 600	5 300	650	21 000 32 000	8E-KV8×12×11.8X1S 0.0040
	12	13	5 050	4 650	565	21 000 32 000	K8×12×13 0.0036
9	12	10 ^{-0.2/-0.55}	4 550	5 000	615	20 000 30 000	K9×12×10T2 0.0015
	12	13 ^{-0.2/-0.55}	5 500	6 400	780	20 000 30 000	K9×12×13T2 0.0021
10	13	10	4 550	5 100	620	19 000 28 000	K10×13×10T2T 0.0016
	13	13	5 450	6 450	790	19 000 28 000	8E-KV10×13×12.8XS 0.0032
	14	8	4 300	3 950	485	19 000 28 000	K10×14×8 0.0027
	14	10 ^{-0.2/-0.55}	5 500	5 450	660	19 000 28 000	K10×14×10T 0.0034
	14	11 ^{-0.2/-0.55}	5 500	5 450	660	19 000 28 000	8E-KV10×14×10.8XS 0.0039
	14	11.5	6 800	7 200	875	19 000 28 000	KMJ10×14×11.3XS 0.0040
14	13	6 600	6 900	840	19 000 28 000	K10×14×13 0.0044	
14	14	7 150	7 650	930	19 000 28 000	8E-KV10×14×13.8X4S 0.0050	

Note: Bearings may be delivered with a different cage type even if they are ordered by the bearing numbers in the table.

F_w 10 ~ 15mm

Boundary dimensions	Basic load rating		Fatigue load limit N C_u	Allowable speed		Number	Mass kg (approx.)
	mm			min ⁻¹			
	F_w	E_w		Grease lubrication	Oil lubrication		
10	14	17 ^{-0.2/-0.55}	8 050	8 850	1 080	19 000 28 000	8E-K10×14×16.8X1 0.0064
	16	12 ^{-0.2/-0.55}	7 100	5 950	730	19 000 28 000	K10×16×12 0.0066
11	14	10 ^{-0.2/-0.55}	5 050	6 000	735	18 000 27 000	K11×14×10 0.0028
12	15	9	4 450	5 250	640	17 000 26 000	K12×15×9 0.0027
	15	10	5 000	6 100	740	17 000 26 000	8Q-K12×15×10 0.0030
	15	13	6 000	7 700	940	17 000 26 000	K12×15×13 0.0038
	15	20	8 550	12 200	1 480	17 000 26 000	K12×15×20ZW 0.0059
	16	8	4 850	4 900	600	17 000 26 000	K12×16×8 0.0034
	16	11.5	6 750	7 400	900	17 000 26 000	KMJ12×16×11.3XS 0.0047
	16	13 ^{-0.2/-0.55}	7 500	8 500	1 040	17 000 26 000	8Q-K12×16×13 0.0060
	16	18	9 800	11 900	1 460	17 000 26 000	8E-K12×16×17.8X1 0.0070
	16	20	10 300	12 800	1 560	17 000 26 000	K12×16×19.8X4 0.010
	17	10	7 350	7 200	880	17 000 26 000	KMJ12×17×9.8XS 0.0050
14	17	13	9 000	9 400	1 150	17 000 26 000	K12×17×13 0.0075
	17	18	12 600	14 400	1 760	17 000 26 000	KV12×17×17.8XS 0.0080
	18	12	8 650	8 000	975	17 000 26 000	8Q-K12×18×12 0.0089
	17	10	5 400	7 050	860	16 000 24 000	KV14×17×10ST 0.0040
	18	10	6 900	8 000	975	16 000 24 000	K14×18×10 0.0046
	18	11	7 600	9 050	1 100	16 000 24 000	K14×18×11 0.0053
	18	13	8 300	10 100	1 240	16 000 24 000	K14×18×13 0.0063
	18	15 ^{-0.2/-0.55}	9 650	12 300	1 500	16 000 24 000	K14×18×15S 0.0076
	18	17 ^{-0.2/-0.55}	10 900	14 400	1 760	16 000 24 000	K14×18×17V5 0.0079
	18	39	18 800	28 900	3 500	16 000 24 000	K14×18×39ZW 0.018
15	19	13	8 950	9 650	1 180	16 000 24 000	K14×19×13 0.0080
	20	12	9 350	9 150	1 110	16 000 24 000	K14×20×12 0.0095
	20	17	13 500	14 600	1 780	16 000 24 000	K14×20×17 0.014
	18	14	7 850	11 600	1 420	15 000 23 000	K15×18×14 0.0060
	19	8 ^{-0.2/-0.55}	5 350	5 850	715	15 000 23 000	KV15×19×7.8XS 0.0033
	19	10 ^{-0.2/-0.55}	6 850	8 050	980	15 000 23 000	K15×19×10T 0.0055
19	13	8 250	10 200	1 250	15 000 23 000	K15×19×13 0.0067	

Note: Bearings may be delivered with a different cage type even if they are ordered by the bearing numbers in the table.

Needle Roller Bearings



Needle roller and cage assemblies

- K type
- K·T2 type
- K·S type
- K·ZW type
- KMJ·S type

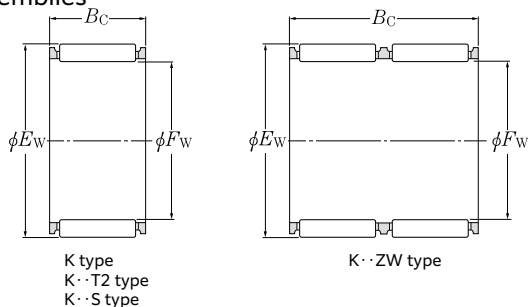

F_w 15 ~ 18mm

	Boundary dimensions			Basic load rating		Fatigue load limit N C_u	Allowable speed		Number	Mass kg (approx.)
	mm			dynamic	static		min^{-1}			
	F_w	E_w	B_c	C_r	C_{0r}		Grease lubrication	Oil lubrication		
15	19	17		10 900	14 600	1 780	15 000	23 000	K15×19×17	0.0090
	19	24		14 100	20 400	2 490	15 000	23 000	K15×19×24ZW	0.013
	20	13		10 100	11 500	1 410	15 000	23 000	K15×20×13	0.0088
	20	16	$_{-0.2}^{-0.55}$	12 600	15 200	1 850	15 000	23 000	KMJ15×20×15.8XS	0.0090
	21	15		11 900	12 500	1 530	15 000	23 000	K15×21×15	0.013
	21	17		14 900	16 800	2 050	15 000	23 000	KMJ15×21×16.8X1SK	0.012
16	21	21		16 500	19 100	2 330	15 000	23 000	K15×21×21	0.017
	20	10		7 500	9 250	1 130	15 000	23 000	K16×20×10T	0.0057
	20	11		8 300	10 500	1 280	15 000	23 000	K16×20×11T	0.0061
	20	13		9 050	11 800	1 430	15 000	23 000	K16×20×13	0.0071
	20	17		11 900	16 800	2 050	15 000	23 000	K16×20×17ST	0.0092
	22	12	$_{-0.2}^{-0.55}$	11 700	12 500	1 530	15 000	23 000	K16×22×12	0.010
	22	13		12 600	13 900	1 690	15 000	23 000	KMJ16×22×13S	0.011
	22	16		13 600	15 200	1 850	15 000	23 000	K16×22×15.8X	0.014
17	22	17		14 400	16 400	2 000	15 000	23 000	K16×22×17	0.015
	22	20		16 000	18 800	2 300	15 000	23 000	K16×22×20	0.017
	21	10		7 450	9 300	1 140	15 000	22 000	K17×21×10S	0.0056
	21	13		9 400	12 600	1 530	15 000	22 000	K17×21×13S	0.0075
	21	15		10 400	14 400	1 750	15 000	22 000	K17×21×15	0.0089
	21	17	$_{-0.2}^{-0.55}$	11 800	16 900	2 060	15 000	22 000	K17×21×17	0.0095
	22	20		14 700	19 200	2 340	15 000	22 000	K17×22×20	0.015
	23	17		14 400	16 500	2 020	15 000	22 000	K17×23×17	0.016
18	23	23		16 800	20 200	2 470	15 000	22 000	K17×23×22.8X1T2	0.013
	22	10		7 400	9 400	1 140	14 000	21 000	K18×22×10	0.0061
	22	13		8 900	11 900	1 450	14 000	21 000	K18×22×13	0.0077
	22	17	$_{-0.2}^{-0.55}$	11 700	17 000	2 070	14 000	21 000	K18×22×17	0.011
	23	20	$_{-0.2}^{-0.55}$	14 600	19 300	2 360	14 000	21 000	K18×23×20S	0.015
	24	12		12 300	13 800	1 690	14 000	21 000	K18×24×12	0.012
24	13		11 600	12 800	1 560	14 000	21 000	K18×24×13	0.013	

Note: Bearings may be delivered with a different cage type even if they are ordered by the bearing numbers in the table.

Needle Roller Bearings

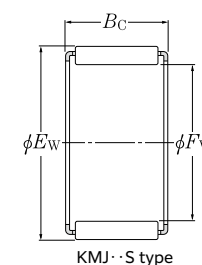

F_w 18 ~ 22mm

	Boundary dimensions			Basic load rating		Fatigue load limit N C_u	Allowable speed		Number	Mass kg (approx.)
	mm			dynamic	static		min^{-1}			
	F_w	E_w	B_c	C_r	C_{0r}		Grease lubrication	Oil lubrication		
18	24	17		16 000	19 300	2 350	14 000	21 000	KMJ18×24×17SV1	0.014
	24	20	$_{-0.2}^{-0.55}$	17 000	20 900	2 550	14 000	21 000	K18×24×20	0.019
	25	17		18 000	20 400	2 490	14 000	21 000	K18×25×17	0.019
	25	22		22 100	26 600	3 250	14 000	21 000	K18×25×22	0.024
19	23	13	$_{-0.2}^{-0.55}$	9 650	13 500	1 640	14 000	21 000	K19×23×13	0.0082
	23	17		12 700	19 200	2 340	14 000	21 000	K19×23×17	0.011
20	24	10		8 300	11 200	1 370	13 000	20 000	K20×24×10S	0.0065
	24	11		9 500	13 400	1 640	13 000	20 000	K20×24×11	0.0072
	24	13		10 000	14 300	1 740	13 000	20 000	K20×24×13SV4	0.0086
	24	17		13 200	20 400	2 480	13 000	20 000	K20×24×17S	0.011
	24	45		16 400	27 100	3 300	13 000	20 000	K20×24×45ZW	0.028
	25	40		29 000	48 000	5 880	13 000	20 000	K20×25×40ZWT	0.033
	26	12	$_{-0.2}^{-0.55}$	12 900	15 100	1 840	13 000	20 000	K20×26×12	0.013
	26	13		14 000	16 700	2 040	13 000	20 000	KMJ20×26×13ST	0.012
	26	14		15 800	19 600	2 390	13 000	13 000	KMJ20×26×13.8X1S	0.013
	26	17		17 800	22 800	2 780	13 000	20 000	KMJ20×26×17S	0.016
	26	20		20 600	27 600	3 350	13 000	20 000	KMJ20×26×20S	0.019
21	28	17		21 700	24 600	3 000	13 000	20 000	KMJ20×28×16.8XS	0.022
	28	20		24 600	28 900	3 500	13 000	20 000	KMJ20×28×19.8X4S	0.026
	28	25		27 100	32 500	3 950	13 000	20 000	8Q-K20×28×25	0.039
	25	13	$_{-0.2}^{-0.55}$	10 700	15 900	1 940	13 000	19 000	KMJ21×25×12.8X1S	0.0081
	25	17		13 600	21 500	2 630	13 000	19 000	K21×25×17	0.012
22	26	10		8 500	11 900	1 450	12 000	18 000	K22×26×10S	0.0071
	26	11		10 100	14 900	1 820	12 000	18 000	8Q-K22×26×11	0.0090
	26	13		10 200	15 200	1 850	12 000	18 000	K22×26×13	0.0094
	26	17	$_{-0.2}^{-0.55}$	13 500	21 600	2 640	12 000	18 000	K22×26×17S	0.012
	27	20	$_{-0.2}^{-0.55}$	17 500	25 900	3 150	12 000	18 000	K22×27×20	0.020
	27	28.5		24 200	39 500	4 800	12 000	18 000	K22×27×28.3X	0.028
	27	40		29 900	51 500	6 300	12 000	18 000	K22×27×40ZW	0.039
	28	17		17 700	23 300	2 850	12 000	18 000	K22×28×17V1	0.020

Note: Bearings may be delivered with a different cage type even if they are ordered by the bearing numbers in the table.

Needle Roller Bearings



Needle roller and cage assemblies

- K type
- K·T2 type
- K·S type
- K·ZW type
- KMJ·S type
- KV·S type

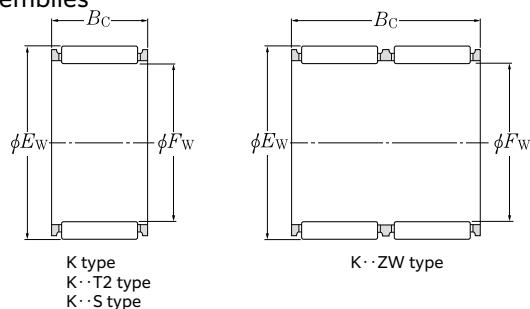

F_w 22 ~ 25mm

	Boundary dimensions			Basic load rating		Fatigue load limit N C_u	Allowable speed		Number	Mass kg (approx.)
	mm			dynamic	static		min^{-1}			
	F_w	E_w	B_c	C_r	C_{0r}		Grease lubrication	Oil lubrication		
22	29	16		18 700	22 700	2 770	12 000	18 000	K22×29×16	0.023
	30	15	$_{-0.2}^{-0.55}$	19 300	21 700	2 640	12 000	18 000	K22×30×15T	0.022
	30	17.5		23 200	27 500	3 350	12 000	18 000	KMJ22×30×17.3X2S	0.024
	30	24		31 000	40 000	4 900	12 000	18 000	KMJ22×30×23.8X3S	0.035
23	27	13		11 400	17 700	2 160	11 000	17 000	KMJ23×27×12.8X1S	0.0086
	28	24	$_{-0.2}^{-0.55}$	19 800	31 000	3 750	11 000	17 000	K23×28×24	0.023
	29	18		20 600	28 800	3 500	11 000	17 000	KMJ23×29×17.8X2S	0.019
24	28	10		9 000	13 200	1 610	11 000	17 000	K24×28×10T	0.0080
	28	13		10 800	16 800	2 050	11 000	17 000	K24×28×13	0.010
	28	17	$_{-0.2}^{-0.55}$	14 300	23 900	2 920	11 000	17 000	K24×28×17	0.013
	29	13		12 300	16 900	2 060	11 000	17 000	K24×29×13	0.012
	30	17		18 400	25 200	3 050	11 000	17 000	K24×30×17	0.022
	30	31		27 900	43 000	5 200	11 000	17 000	K24×30×31ZW	0.039
25	29	10		8 950	13 300	1 620	11 000	16 000	K25×29×10	0.0083
	29	13		10 800	16 900	2 050	11 000	16 000	K25×29×13	0.010
	29	17		14 200	24 000	2 930	11 000	16 000	K25×29×17S	0.014
	30	13		13 200	18 800	2 290	11 000	16 000	K25×30×13	0.013
	30	17		17 400	26 800	3 250	11 000	16 000	K25×30×17S	0.017
	30	20		19 400	31 000	3 750	11 000	16 000	K25×30×20SV3	0.021
	30	22		22 300	37 000	4 500	11 000	16 000	KMJ25×30×21.8XS	0.020
	30	26	$_{-0.2}^{-0.55}$	21 800	35 500	4 350	11 000	16 000	K25×30×26ZW	0.027
	30	39	$_{-0.2}^{-0.55}$	29 800	53 500	6 550	11 000	16 000	K25×30×39ZW	0.040
	31	13		15 200	19 900	2 430	11 000	16 000	K25×31×13V3	0.018
	31	14		16 500	22 100	2 700	11 000	16 000	K25×31×14	0.018
	31	17		18 300	25 300	3 100	11 000	16 000	K25×31×17	0.022
	31	18.5		21 000	30 000	3 650	11 000	16 000	KMJ25×31×18.3X1SK	0.021
	31	21		22 500	33 000	4 000	11 000	16 000	K25×31×21V3	0.028
	32	16		19 500	24 700	3 000	11 000	16 000	K25×32×16	0.027
33	24		34 500	47 000	5 750	11 000	16 000	KMJ25×33×24S	0.040	

Note: Bearings may be delivered with a different cage type even if they are ordered by the bearing numbers in the table.

Needle Roller Bearings

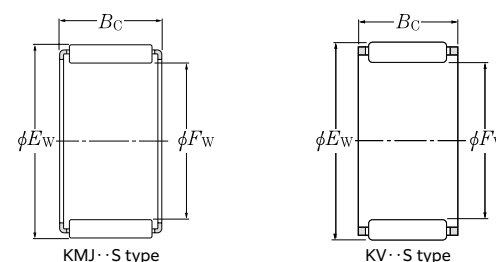

F_w 26 ~ 30mm

	Boundary dimensions			Basic load rating		Fatigue load limit N C_u	Allowable speed		Number	Mass kg (approx.)
	mm			dynamic	static		min^{-1}			
	F_w	E_w	B_c	C_r	C_{0r}		Grease lubrication	Oil lubrication		
26	30	13		11 800	19 200	2 340	10 000	15 000	K26×30×13	0.011
	30	17	$_{-0.2}^{-0.55}$	15 500	27 400	3 350	10 000	15 000	K26×30×17	0.015
	31	24		21 400	35 500	4 300	10 000	15 000	8E-K26×31×23.8X1ZW	0.029
	34	22		24 200	30 000	3 700	10 000	15 000	K26×34×22	0.041
28	32	17		15 300	27 500	3 350	9 500	14 000	K28×32×17	0.017
	32	21		18 700	35 500	4 350	9 500	14 000	K28×32×21T	0.020
	33	13		13 900	20 900	2 550	9 500	14 000	K28×33×13	0.015
	33	17		18 300	29 800	3 650	9 500	14 000	K28×33×17S	0.020
	33	26	$_{-0.2}^{-0.55}$	23 900	42 000	5 100	9 500	14 000	K28×33×26ZW	0.033
	33	27		28 300	52 000	6 350	9 500	14 000	K28×33×27	0.032
	34	14		17 500	24 800	3 000	9 500	14 000	K28×34×14	0.020
	34	17		18 100	25 800	3 150	9 500	14 000	K28×34×17V1	0.025
	35	16		21 200	28 400	3 450	9 500	14 000	K28×35×16	0.029
	35	18		21 500	28 900	3 550	9 500	14 000	K28×35×18	0.031
29	34	17	$_{-0.2}^{-0.55}$	18 900	31 000	3 800	9 500	14 000	K29×34×17S	0.022
	34	27		28 100	52 000	6 350	9 500	14 000	K29×34×27	0.033
30	34	14		12 400	21 500	2 600	8 500	13 000	KV30×34×13.8XS	0.014
	34	23		18 000	34 500	4 200	8 500	13 000	K30×34×22.8X1T2	0.013
	35	11		12 200	18 000	2 200	8 500	13 000	K30×35×11S	0.014
	35	13		14 700	22 900	2 800	8 500	13 000	KV30×35×13S	0.017
	35	20		21 600	37 500	4 600	8 500	13 000	K30×35×20S	0.025
	35	26	$_{-0.2}^{-0.55}$	25 200	46 000	5 600	8 500	13 000	K30×35×26ZWV1	0.036
	35	27		29 900	57 000	6 950	8 500	13 000	K30×35×27S	0.033
	37	16		21 900	30 500	3 700	8 500	13 000	K30×37×16	0.029
	37	18		23 300	33 000	4 000	8 500	13 000	K30×37×18	0.034
	37	20		26 200	38 000	4 650	8 500	13 000	KMJ30×37×20S	0.032
	37	48		40 000	65 500	8 000	8 500	13 000	K30×37×48ZW	0.075
	38	18		25 000	33 000	4 000	8 500	13 000	K30×38×18	0.036

Note: Bearings may be delivered with a different cage type even if they are ordered by the bearing numbers in the table.

Needle Roller Bearings



Needle roller and cage assemblies

- K type
- K·T2 type
- K·S type
- K·ZW type
- KMJ·S type
- KV·S type

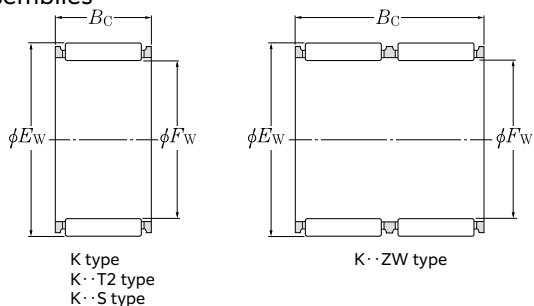

Needle Roller Bearings

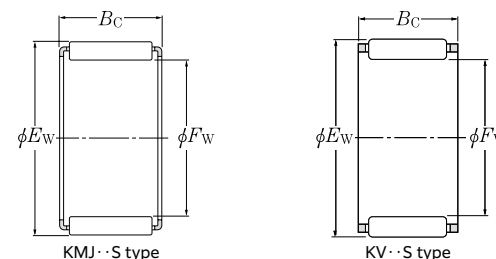

F_w 31 ~ 35mm

	Boundary dimensions			Basic load rating		Fatigue load limit N C_u	Allowable speed		Number	Mass kg (approx.)
	mm			dynamic	static		min ⁻¹			
	F_w	E_w	B_c	C_r	C_{0r}		Grease lubrication	Oil lubrication		
31	35	24	-0.2 -0.55	21 200	43 500	5 300	8 500	13 000	KV31×35×23.8XS	0.022
	36	14	-0.2 -0.55	15 800	25 400	3 100	8 500	13 000	KV31×36×13.8XS	0.017
32	36	15		14 300	26 400	3 200	8 500	13 000	K32×36×15ST	0.017
	37	13		14 500	23 000	2 810	8 500	13 000	K32×37×13	0.018
	37	17		19 200	33 000	4 000	8 500	13 000	K32×37×17S	0.022
	37	26		24 900	46 000	5 600	8 500	13 000	K32×37×26ZWV3	0.032
	37	27	-0.2 -0.55	29 600	57 500	7 000	8 500	13 000	K32×37×27	0.037
	38	14		19 800	30 500	3 700	8 500	13 000	KMJ32×38×14S	0.022
	38	26		31 500	54 000	6 600	8 500	13 000	K32×38×26	0.041
	39	16		22 600	32 000	3 900	8 500	13 000	K32×39×16V1	0.033
	39	18		24 000	35 000	4 250	8 500	13 000	K32×39×18	0.037
33	38	30.5	-0.2 -0.55	28 400	55 000	6 700	8 000	12 000	K33×38×30.3X1T2	0.026
34	40	39.5	-0.2 -0.55	39 000	73 500	8 950	8 000	12 000	KV34×40×39.3X1ZWS	0.066
35	39	22.5		21 500	46 000	5 600	7 500	11 000	KV35×39×22.3XS	0.024
	39	24		21 300	45 000	5 500	7 500	11 000	K35×39×23.8X1T2	0.015
	40	13		15 200	25 100	3 050	7 500	11 000	K35×40×13	0.019
	40	17		20 000	36 000	4 350	7 500	11 000	K35×40×17	0.025
	40	19		22 300	41 000	5 000	7 500	11 000	K35×40×19	0.029
	40	26		26 100	50 000	6 100	7 500	11 000	K35×40×26ZW	0.037
	40	30	-0.2 -0.55	26 100	50 000	6 100	7 500	11 000	K35×40×30ZW	0.043
	41	14		19 400	30 500	3 700	7 500	11 000	K35×41×14	0.026
	41	15		20 900	33 500	4 050	7 500	11 000	K35×41×15	0.027
	41	24		31 000	55 500	6 800	7 500	11 000	K35×41×23.8X1	0.042
	41	40		43 000	84 000	10 200	7 500	11 000	K35×41×40ZW	0.055
	42	16		24 100	36 000	4 350	7 500	11 000	K35×42×16	0.035
	42	18		24 700	37 000	4 500	7 500	11 000	K35×42×18	0.039

Note: Bearings may be delivered with a different cage type even if they are ordered by the bearing numbers in the table.

F_w 35 ~ 42mm

	Boundary dimensions			Basic load rating		Fatigue load limit N C_u	Allowable speed		Number	Mass kg (approx.)
	mm			dynamic	static		min ⁻¹			
	F_w	E_w	B_c	C_r	C_{0r}		Grease lubrication	Oil lubrication		
35	42	20		26 500	40 500	4 950	7 500	11 000	KV35×42×20SV2	0.040
	42	30	-0.2 -0.55	39 500	68 000	8 300	7 500	11 000	K35×42×30	0.062
	42	45		42 500	74 000	9 000	7 500	11 000	K35×42×45ZW	0.106
36	42	46	-0.2 -0.55	51 000	106 000	12 900	7 500	11 000	K36×42×46ZW	0.086
37	42	13		15 900	27 100	3 300	7 500	11 000	K37×42×13V4	0.021
	42	17		21 000	38 500	4 700	7 500	11 000	K37×42×17V2	0.026
	43	33.5	-0.2 -0.55	39 000	76 000	9 250	7 500	11 000	KV37×43×33.3XS	0.062
	44	18		26 300	41 000	5 000	7 500	11 000	K37×44×18	0.042
	45	25		37 000	58 000	7 050	7 500	11 000	K37×45×24.8XT2	0.039
38	43	17		20 900	38 500	4 700	7 500	11 000	8E-K38×43×17	0.027
	43	27		32 000	67 500	8 250	7 500	11 000	K38×43×27	0.043
	43	29	-0.2 -0.55	32 500	68 000	8 300	7 500	11 000	K38×43×28.8X	0.047
	46	32		54 000	95 500	11 600	7 500	11 000	K38×46×32	0.073
40	45	13		16 500	29 200	3 550	6 500	10 000	K40×45×13V2	0.023
	45	17		21 800	41 500	5 100	6 500	10 000	K40×45×17T	0.027
	45	21		26 700	54 000	6 600	6 500	10 000	K40×45×21V2	0.035
	45	27		33 500	72 500	8 850	6 500	10 000	K40×45×27	0.044
	46	17	-0.2 -0.55	24 600	43 000	5 200	6 500	10 000	K40×46×17	0.030
	46	34	-0.2 -0.55	40 500	80 500	9 850	6 500	10 000	KV40×46×33.8XS	0.063
	47	18		27 700	45 000	5 450	6 500	10 000	K40×47×18	0.045
	47	20		31 000	51 500	6 300	6 500	10 000	K40×47×20	0.048
	48	20		33 000	51 000	6 250	6 500	10 000	K40×48×20	0.052
	48	25		41 000	68 000	8 300	6 500	10 000	KV40×48×25SV1	0.065
41	49	22	-0.2 -0.55	30 500	46 000	5 650	6 500	9 500	8E-KV41×49×21.8XS	0.065
42	47	17		22 100	43 000	5 250	6 500	9 500	K42×47×17	0.028
	47	27	-0.2 -0.55	34 000	75 500	9 200	6 500	9 500	K42×47×27	0.047
	48	17	-0.2 -0.55	25 700	46 000	5 650	6 500	9 500	K42×48×17	0.036
	50	20		34 000	53 500	6 550	6 500	9 500	K42×50×20	0.054

Note: Bearings may be delivered with a different cage type even if they are ordered by the bearing numbers in the table.

Needle roller and cage assemblies

- K type
- K·T2 type
- K·ZW type
- KV·S type
- KVS·ZWS type

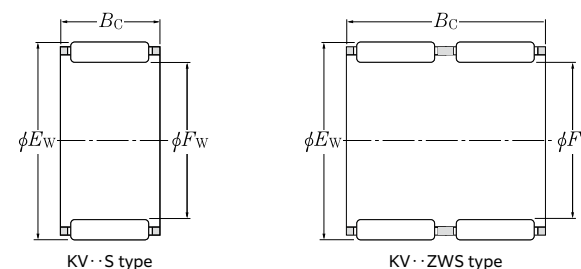
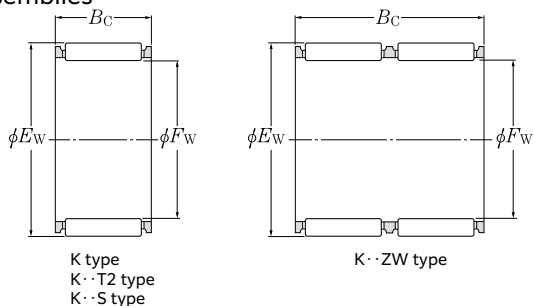

F_w 43 ~ 50mm

	Boundary dimensions			Basic load rating		Fatigue load limit N C_u	Allowable speed		Number	Mass kg (approx.)
	mm			dynamic	static		min^{-1}			
	F_w	E_w	B_c	C_r	C_{0r}		Grease lubrication	Oil lubrication		
43	48	17		22 000	43 000	5 250	6 500	9 500	K43×48×17	0.029
	48	27	$_{-0.2}^{-0.55}$	34 000	75 500	9 200	6 500	9 500	K43×48×27	0.046
	48	38	$_{-0.2}^{-0.55}$	41 000	96 000	11 700	6 500	9 500	KV43×48×37.8XZWS	0.058
	50	18		29 100	49 000	5 950	6 500	9 500	K43×50×18	0.049
44	50	31	$_{-0.2}^{-0.55}$	43 500	91 500	11 100	6 500	9 500	KV44×50×30.8XS	0.067
45	49	19		22 100	52 000	6 350	6 000	9 000	K45×49×19	0.027
	50	17		22 300	44 500	5 450	6 000	9 000	K45×50×17V3	0.033
	50	25.8		30 500	66 500	8 100	6 000	9 000	KV45×50×25.8XS	0.045
	50	27		34 500	78 000	9 500	6 000	9 000	K45×50×27	0.050
	51	27	$_{-0.2}^{-0.55}$	34 500	68 000	8 300	6 000	9 000	KV45×51×26.8XS	0.058
	52	18		29 700	51 000	6 200	6 000	9 000	K45×52×18	0.051
	52	21		32 000	56 500	6 900	6 000	9 000	K45×52×21	0.061
	53	20		36 000	59 000	7 200	6 000	9 000	K45×53×20	0.062
47	53	25		46 500	82 000	10 000	6 000	9 000	K45×53×25	0.077
	52	15.5		19 400	38 000	4 650	5 500	8 500	8E-K47×52×15.3X2	0.031
	52	17		23 200	47 500	5 800	5 500	8 500	K47×52×17	0.033
	52	23	$_{-0.2}^{-0.55}$	29 600	65 500	7 950	5 500	8 500	KV47×52×22.8X2S	0.044
	52	24	$_{-0.2}^{-0.55}$	33 500	76 500	9 350	5 500	8 500	K47×52×23.8X	0.044
	52	27		35 500	83 000	10 100	5 500	8 500	K47×52×27	0.051
	52	33		38 000	90 500	11 100	5 500	8 500	KV47×52×32.8XZWS	0.064
48	53	22.5		31 000	69 500	8 450	5 500	8 500	KV48×53×22.3XS	0.042
	53	26		36 500	86 500	10 600	5 500	8 500	K48×53×25.8X3T2	0.029
	53	30		36 500	85 500	10 400	5 500	8 500	K48×53×29.8X1	0.062
	53	37	$_{-0.2}^{-0.55}$	45 000	112 000	13 700	5 500	8 500	KV48×53×36.8XZWS	0.064
	53	37.5	$_{-0.2}^{-0.55}$	41 500	101 000	12 300	5 500	8 500	K48×53×37.5ZW	0.072
	54	19		31 000	61 000	7 450	5 500	8 500	K48×54×19	0.044
	55	24.5		39 000	74 500	9 050	5 500	8 500	KV48×55×24.3XS	0.070
50	55	13.5	$_{-0.2}^{-0.55}$	18 100	35 500	4 300	5 500	8 000	K50×55×13.5T	0.023
	55	20	$_{-0.2}^{-0.55}$	27 900	62 000	7 550	5 500	8 000	KV50×55×20S	0.040

Note: Bearings may be delivered with a different cage type even if they are ordered by the bearing numbers in the table.

F_w 50 ~ 60mm

	Boundary dimensions			Basic load rating		Fatigue load limit N C_u	Allowable speed		Number	Mass kg (approx.)	
	mm			dynamic	static		min^{-1}				
	F_w	E_w	B_c	C_r	C_{0r}		Grease lubrication	Oil lubrication			
50	55	27		37 000	88 500	10 800	5 500	8 000	K50×55×27	0.053	
	55	30		39 500	97 000	11 800	5 500	8 000	K50×55×30	0.059	
	57	18		31 500	57 000	6 950	5 500	8 000	K50×57×18	0.053	
	58	20	$_{-0.2}^{-0.55}$	38 500	67 500	8 200	5 500	8 000	K50×58×20	0.065	
	58	25		48 500	90 000	11 000	5 500	8 000	K50×58×25	0.081	
	58	58		83 500	181 000	22 100	5 500	8 000	KV50×58×57.8XZWS	0.188	
52	57	18		22 800	48 000	5 850	5 000	7 500	KV52×57×17.8XS	0.037	
	57	23	$_{-0.2}^{-0.55}$	30 500	69 500	8 500	5 000	7 500	KV52×57×22.8X1S	0.048	
	58	19		32 000	65 500	7 950	5 000	7 500	K52×58×19	0.048	
54	59	23	$_{-0.2}^{-0.55}$	31 500	73 500	8 950	5 000	7 500	KV54×59×22.8XS	0.049	
55	60	17		25 800	58 000	7 050	5 000	7 500	K55×60×17	0.043	
	60	20		28 800	66 500	8 100	5 000	7 500	K55×60×20T	0.045	
	60	30		42 000	108 000	13 200	5 000	7 500	KV55×60×30S	0.069	
	60	37		47 500	127 000	15 500	5 000	7 500	K55×60×36.8X	0.086	
	61	19		33 000	69 500	8 450	5 000	7 500	K55×61×19	0.051	
	61	20	$_{-0.2}^{-0.55}$	33 000	69 500	8 450	5 000	7 500	K55×61×20	0.054	
	61	30		48 000	113 000	13 700	5 000	7 500	K55×61×30	0.081	
	62	18		33 500	63 000	7 700	5 000	7 500	K55×62×18	0.054	
	63	20		39 000	70 000	8 500	5 000	7 500	K55×63×20	0.073	
	63	25		50 500	97 500	11 900	5 000	7 500	K55×63×25	0.088	
56	63	32		61 000	125 000	15 200	5 000	7 500	K55×63×32	0.117	
	66	41	$_{-0.2}^{-0.55}$	90 000	178 000	21 700	5 000	7 500	K56×66×40.8XT2	0.148	
	65	40	$_{-0.2}^{-0.55}$	66 000	140 000	17 100	4 700	7 000	KV57×65×39.8XZWS	0.145	
	64	19	$_{-0.2}^{-0.55}$	34 000	73 500	8 950	4 700	7 000	K58×64×19	0.052	
	60	65	20		29 800	71 500	8 750	4 300	6 500	K60×65×20	0.051
		65	27		40 000	104 000	12 700	4 300	6 500	K60×65×26.8X	0.067
		65	30	$_{-0.2}^{-0.55}$	43 500	116 000	14 200	4 300	6 500	K60×65×30	0.071
		66	19		33 500	73 500	8 950	4 300	6 500	K60×66×19	0.053
		66	20		33 500	73 500	8 950	4 300	6 500	K60×66×20	0.056

Note: Bearings may be delivered with a different cage type even if they are ordered by the bearing numbers in the table.

Needle Roller Bearings



Needle roller and cage assemblies

- K type
- K·T2 type
- K·ZW type
- KV·S type
- KVS·ZWS type

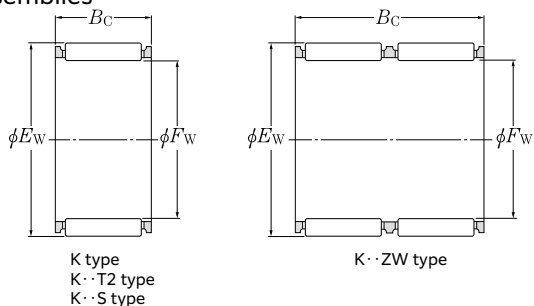

Needle Roller Bearings

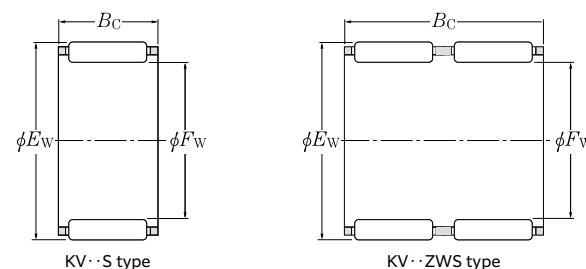

F_w 60 ~ 73mm

	Boundary dimensions			Basic load rating		Fatigue load limit N C_u	Allowable speed		Number	Mass kg (approx.)
	mm			dynamic	static		min^{-1}			
	F_w	E_w	B_c	C_r	C_{0r}		Grease lubrication	Oil lubrication		
60	66	30		49 000	119 000	14 600	4 300	6 500	K60×66×30	0.084
	68	15		27 200	45 500	5 550	4 300	6 500	K60×68×15	0.058
	68	20		40 000	75 000	9 200	4 300	6 500	K60×68×20	0.077
	68	23	$_{-0.2}^{-0.55}$	44 500	85 000	10 400	4 300	6 500	K60×68×23	0.092
	68	25		52 000	105 000	12 800	4 300	6 500	K60×68×25T	0.097
	68	27		52 000	105 000	12 800	4 300	6 500	K60×68×27	0.098
	68	30		46 500	91 000	11 100	4 300	6 500	K60×68×30ZW	0.119
61	66	20	$_{-0.2}^{-0.55}$	29 700	71 500	8 750	4 300	6 500	K61×66×20	0.054
	66	30	$_{-0.2}^{-0.55}$	43 500	116 000	14 200	4 300	6 500	K61×66×30	0.073
63	70	21	$_{-0.2}^{-0.55}$	44 500	95 500	11 600	4 300	6 500	K63×70×21	0.075
	71	50.5	$_{-0.2}^{-0.55}$	74 500	167 000	20 400	4 300	6 500	KV63×71×50.3XZWS	0.193
64	70	16	$_{-0.2}^{-0.55}$	28 400	60 500	7 350	4 300	6 500	K64×70×16	0.053
65	70	20		30 500	75 000	9 150	4 000	6 000	K65×70×20	0.055
	70	21.5		30 500	75 000	9 150	4 000	6 000	KV65×70×21.3X1S	0.056
	70	30	$_{-0.2}^{-0.55}$	45 000	124 000	15 200	4 000	6 000	K65×70×30	0.083
	73	23		47 000	94 000	11 500	4 000	6 000	K65×73×23	0.100
	73	30		61 000	132 000	16 000	4 000	6 000	K65×73×30	0.126
68	74	20		36 000	83 500	10 200	4 000	6 000	K68×74×20	0.065
	74	30	$_{-0.2}^{-0.55}$	51 500	133 000	16 200	4 000	6 000	K68×74×30	0.097
	74	35	$_{-0.2}^{-0.55}$	49 500	125 000	15 300	4 000	6 000	K68×74×35ZW	0.116
	75	21		45 500	101 000	12 300	4 000	6 000	K68×75×21	0.077
70	76	20		36 500	86 000	10 500	3 700	5 500	K70×76×20	0.070
	76	30		53 000	139 000	17 000	3 700	5 500	K70×76×30	0.100
	77	21	$_{-0.2}^{-0.55}$	45 000	101 000	12 300	3 700	5 500	K70×77×21	0.080
	78	23		49 500	103 000	12 600	3 700	5 500	K70×78×23	0.107
	78	30		65 500	149 000	18 100	3 700	5 500	K70×78×30	0.136
72	79	21	$_{-0.2}^{-0.55}$	46 500	106 000	12 900	3 700	5 500	K72×79×21	0.085
73	79	20	$_{-0.2}^{-0.55}$	37 500	90 000	11 000	3 700	5 500	K73×79×20	0.074
	79	30	$_{-0.2}^{-0.55}$	54 500	146 000	17 800	3 700	5 500	K73×79×30	0.106

Note: Bearings may be delivered with a different cage type even if they are ordered by the bearing numbers in the table.

F_w 74 ~ 100mm

	Boundary dimensions			Basic load rating		Fatigue load limit N C_u	Allowable speed		Number	Mass kg (approx.)
	mm			dynamic	static		min^{-1}			
	F_w	E_w	B_c	C_r	C_{0r}		Grease lubrication	Oil lubrication		
74	90	50	$_{-0.2}^{-0.55}$	157 000	287 000	35 000	3 700	5 500	K74×90×49.8XT2	0.380
75	81	20		40 000	99 500	12 200	3 700	5 500	KV75×81×19.8X1S	0.071
	81	30		56 000	152 000	18 600	3 700	5 500	K75×81×30	0.108
	82	21	$_{-0.2}^{-0.55}$	46 000	106 000	13 000	3 700	5 500	K75×82×21	0.088
	83	23		50 500	109 000	13 300	3 700	5 500	K75×83×23	0.113
	83	30		67 500	157 000	19 200	3 700	5 500	K75×83×30	0.147
80	86	20		39 000	98 000	11 900	3 300	5 000	KV80×86×20SV1	0.077
	86	30		57 000	159 000	19 400	3 300	5 000	K80×86×30	0.110
	88	23	$_{-0.2}^{-0.55}$	53 000	118 000	14 400	3 300	5 000	K80×88×23	0.125
	88	26	$_{-0.2}^{-0.55}$	61 000	142 000	17 300	3 300	5 000	K80×88×26	0.131
85	88	30		69 000	166 000	20 300	3 300	5 000	K80×88×30	0.157
	92	30		66 000	176 000	21 500	3 100	4 700	K85×92×30	0.142
	93	27	$_{-0.2}^{-0.55}$	64 000	153 000	18 700	3 100	4 700	K85×93×27	0.145
	93	30		71 000	175 000	21 400	3 100	4 700	8Q-K85×93×30	0.174
90	97	20		46 000	113 000	13 700	2 900	4 400	K90×97×20	0.103
	97	30		67 500	184 000	22 400	2 900	4 400	K90×97×30	0.151
	98	26	$_{-0.2}^{-0.55}$	64 000	157 000	19 200	2 900	4 400	K90×98×26	0.148
	98	27	$_{-0.2}^{-0.55}$	64 000	157 000	19 200	2 900	4 400	K90×98×27	0.150
95	98	30		72 500	184 000	22 400	2 900	4 400	K90×98×30	0.172
	102	21		48 000	122 000	14 900	2 800	4 200	K95×102×21	0.115
	102	31	$_{-0.2}^{-0.55}$	70 500	199 000	24 300	2 800	4 200	K95×102×31	0.172
	103	27	$_{-0.2}^{-0.55}$	65 500	165 000	20 100	2 800	4 200	K95×103×27	0.159
	103	30		74 000	193 000	23 500	2 800	4 200	K95×103×30	0.165
100	107	21		47 500	122 000	14 700	2 700	4 000	KV100×107×21S	0.120
	107	31	$_{-0.3}^{-0.65}$	71 500	207 000	24 900	2 700	4 000	K100×107×31	0.173
	108	27	$_{-0.3}^{-0.65}$	61 000	153 000	18 400	2 700	4 000	K100×108×27	0.176
	108	30		76 000	201 000	24 300	2 700	4 000	K100×108×30	0.190

Note: Bearings may be delivered with a different cage type even if they are ordered by the bearing numbers in the table.

Needle roller and cage assemblies

K type
K·L1 type

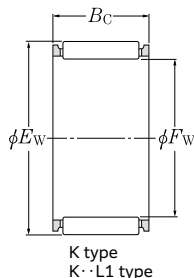

F_w 105 ~ 170mm

	Boundary dimensions			Basic load rating		Fatigue load limit N C_u	Allowable speed		Number	Mass kg (approx.)
	mm			dynamic	static		min ⁻¹			
	F_w	E_w	B_c	C_r	C_{0r}		Grease lubrication	Oil lubrication		
105	112	21		48 500	127 000	15 100	2 500	3 800	K105×112×21	0.130
	112	31	$_{-0.3}^{0.65}$	71 000	207 000	24 600	2 500	3 800	K105×112×31	0.176
	113	30		77 500	210 000	25 000	2 500	3 800	K105×113×30	0.198
110	117	24		54 500	149 000	17 500	2 400	3 600	K110×117×24	0.145
	117	34	$_{-0.3}^{0.65}$	77 500	235 000	27 600	2 400	3 600	K110×117×34	0.205
	118	30		79 000	219 000	25 700	2 400	3 600	K110×118×30	0.217
115	123	27	$_{-0.3}^{0.65}$	64 000	170 000	19 700	2 300	3 500	K115×123×27	0.200
	125	34	$_{-0.3}^{0.65}$	95 000	241 000	27 800	2 300	3 500	K115×125×34	0.330
120	127	24	$_{-0.3}^{0.65}$	57 500	165 000	18 900	2 200	3 300	K120×127×24	0.160
	127	34	$_{-0.3}^{0.65}$	82 000	260 000	29 800	2 200	3 300	K120×127×34	0.235
125	133	35	$_{-0.3}^{0.65}$	87 000	260 000	29 300	2 100	3 200	K125×133×35	0.275
	135	34	$_{-0.3}^{0.65}$	100 000	265 000	29 800	2 100	3 200	K125×135×34	0.350
130	137	24	$_{-0.3}^{0.65}$	59 000	175 000	19 600	2 100	3 100	K130×137×24	0.170
	137	34	$_{-0.3}^{0.65}$	84 500	277 000	31 000	2 100	3 100	K130×137×34	0.240
135	143	35	$_{-0.3}^{0.65}$	92 500	288 000	32 000	2 000	3 000	K135×143×35L1	0.313
	150	38	$_{-0.3}^{0.65}$	145 000	325 000	36 000	2 000	3 000	K135×150×38	0.590
145	153	26		72 000	214 000	23 100	1 900	2 800	K145×153×26	0.250
	153	28	$_{-0.3}^{0.65}$	80 500	247 000	26 700	1 900	2 800	K145×153×28	0.252
	153	36		100 000	325 000	35 000	1 900	2 800	K145×153×36	0.335
150	160	46	$_{-0.3}^{0.65}$	149 000	470 000	50 500	1 800	2 700	K150×160×46	0.550
115	163	26	$_{-0.3}^{0.65}$	73 500	224 000	23 800	1 700	2 600	K155×163×26	0.270
	163	36	$_{-0.3}^{0.65}$	102 000	340 000	36 000	1 700	2 600	K155×163×36	0.355
160	170	46	$_{-0.3}^{0.65}$	155 000	505 000	53 000	1 700	2 500	K160×170×46	0.570
165	173	26		79 000	251 000	26 100	1 600	2 400	K165×173×26	0.290
	173	32	$_{-0.3}^{0.65}$	97 000	330 000	34 000	1 600	2 400	K165×173×32	0.340
	173	36		109 000	380 000	39 500	1 600	2 400	K165×173×36	0.375
170	180	46	$_{-0.3}^{0.65}$	160 000	540 000	55 500	1 600	2 400	K170×180×46	0.620

Note: Bearings may be delivered with a different cage type even if they are ordered by the bearing numbers in the table.

F_w 175 ~ 285mm

	Boundary dimensions			Basic load rating		Fatigue load limit N C_u	Allowable speed		Number	Mass kg (approx.)
	mm			dynamic	static		min ⁻¹			
	F_w	E_w	B_c	C_r	C_{0r}		Grease lubrication	Oil lubrication		
175	183	32	$_{-0.3}^{0.65}$	101 000	350 000	36 000	1 500	2 300	K175×183×32L1	0.379
185	195	37	$_{-0.3}^{0.65}$	131 000	425 000	43 000	1 500	2 200	K185×195×37L1	0.581
195	205	37	$_{-0.3}^{0.65}$	135 000	450 000	44 500	1 400	2 100	K195×205×37L1	0.620
210	220	42	$_{-0.3}^{0.65}$	156 000	560 000	54 000	1 300	1 900	K210×220×42	0.740
220	230	42	$_{-0.3}^{0.65}$	161 000	590 000	56 500	1 200	1 800	K220×230×42	0.790
240	250	42	$_{-0.3}^{0.65}$	167 000	635 000	59 000	1 100	1 700	K240×250×42L1	0.849
265	280	50	$_{-0.3}^{0.65}$	256 000	850 000	77 000	1 000	1 500	K265×280×50L1	1.77
285	300	50	$_{-0.3}^{0.65}$	268 000	930 000	82 000	950	1 400	K285×300×50	1.97

Note: Bearings may be delivered with a different cage type even if they are ordered by the bearing numbers in the table.

Drawn cup needle roller bearings

HK type, HK · ZWD type
HMK type
BK type, BK · ZWD type

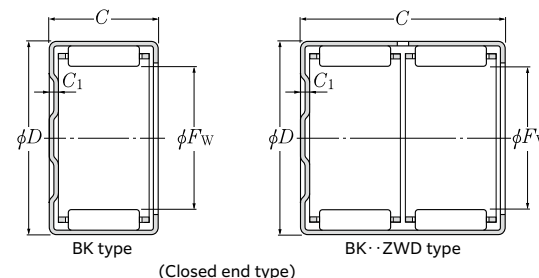
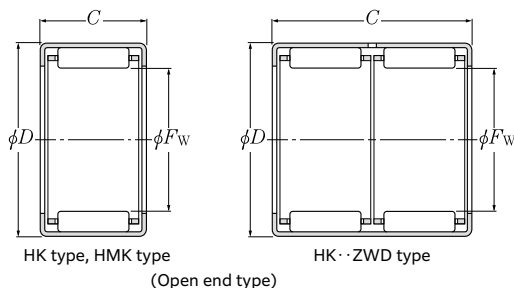

F_w 3 ~ 10mm

	Boundary dimensions mm			Basic load rating		Fatigue load limit N C_{11}	Allowable speed		Number		Mass kg (approx.)	Applied inner ring ¹⁾ (approx.)
	F_w	D	Max.	dynamic N C_r	static N C_{0r}		min ⁻¹ Grease lubrication	Oil lubrication	Open end type	Closed end type		
3	6.5	6	—	925	565	69	33 000	50 000	HK0306FT2	—	0.0006	—
	6.5	6	0.8	925	565	69	33 000	50 000	—	BK0306T2	0.0007	—
4	8	8	—	1 770	1 270	155	30 000	45 000	HK0408FT2	—	0.0016	—
	8	8	1.6	1 770	1 270	155	30 000	45 000	—	BK0408T2	0.0018	—
5	9	9	—	2 450	1 990	243	27 000	40 000	HK0509FM	—	0.0019	—
	9	9	1.6	2 450	1 990	243	27 000	40 000	—	BK0509	0.0021	—
6	10	9	—	2 920	2 590	315	25 000	37 000	HK0609FM	—	0.0022	—
	10	9	1.6	2 660	2 280	278	25 000	37 000	—	BK0609T2	0.0024	—
7	11	9	—	3 150	2 930	355	23 000	34 000	HK0709FM	—	0.0025	—
	11	9	1.6	3 150	2 930	355	23 000	34 000	—	BK0709CT	0.0027	—
8	12	10	—	3 850	3 950	480	20 000	30 000	HK0810FM	—	0.0032	IR 5 × 8×12
	12	10	1.6	3 850	3 950	480	20 000	30 000	—	BK0810CT	0.0034	IR 5 × 8×12
	15	10	—	4 200	3 300	400	20 000	30 000	HMK0810CT	—	0.0067	IR 5 × 8×12
	15	15	—	7 300	6 650	770	20 000	30 000	HMK0815CT	—	0.010	IR 5 × 8×16
9	13	10	—	4 300	4 650	570	18 000	27 000	HK0910FM	—	0.0035	IR 6 × 9×12
	13	10	1.6	4 300	4 650	570	18 000	27 000	—	BK0910CT	0.0039	IR 6 × 9×12
	13	12	—	5 400	6 250	765	18 000	27 000	HK0912F	—	0.0042	IR 6 × 9×12
	13	12	1.6	5 400	6 250	765	18 000	27 000	—	BK0912CT	0.0045	IR 6 × 9×12
10	16	12	—	5 300	4 450	545	18 000	27 000	HMK0912	—	0.0087	IR 6 × 9×16
	16	16	—	7 400	6 850	840	18 000	27 000	HMK0916	—	0.012	—
	14	10	—	4 500	5 100	620	16 000	24 000	HK1010FM	—	0.0038	IR 7×10×10.5
	14	10	1.6	4 500	5 100	620	16 000	24 000	—	BK1010	0.0042	IR 7×10×10.5
10	14	12	—	5 650	6 800	830	16 000	24 000	HK1012F	—	0.0045	IR 7×10×16
	14	12	1.6	5 900	7 250	880	16 000	24 000	—	BK1012	0.0050	IR 7×10×16
	14	15	—	7 250	9 400	1 140	16 000	24 000	HK1015F	—	0.0056	IR 7×10×16
	14	15	1.6	7 250	9 400	1 140	16 000	24 000	—	BK1015CT	0.0062	IR 7×10×16
	17	10	—	4 250	3 450	420	16 000	24 000	HMK1010	—	0.0079	IR 7×10×10.5
	17	12	—	5 600	4 850	590	16 000	24 000	HMK1012	—	0.0094	IR 7×10×16

1) If the bearing has an inner ring, the value indicates HK + IR.
Example: HK1012F + IR7 × 10 × 16

F_w 10 ~ 15mm

	Boundary dimensions mm			Basic load rating		Fatigue load limit N C_{11}	Allowable speed		Number		Mass kg (approx.)	Applied inner ring ¹⁾ (approx.)
	F_w	D	Max.	dynamic N C_r	static N C_{0r}		min ⁻¹ Grease lubrication	Oil lubrication	Open end type	Closed end type		
10	17	15	—	7 400	6 950	850	16 000	24 000	HMK1015	—	0.012	IR 7×10×16
	17	20	—	9 900	10 100	1 240	16 000	24 000	7E-HMK1020CT	—	0.016	—
12	16	10	—	5 050	6 250	760	13 000	20 000	HK1210FM	—	0.0046	IR 8×12×10.5
	16	10	1.6	5 050	6 250	760	13 000	20 000	—	BK1210	0.0052	IR 8×12×10.5
	18	12	—	6 600	7 300	890	13 000	20 000	HK1212FM	—	0.0091	IR 8×12×12.5
	18	12	2.7	6 600	7 300	890	13 000	20 000	—	BK1212	0.010	IR 8×12×12.5
13	19	12	—	7 100	6 900	845	13 000	20 000	HMK1212	—	0.011	IR 8×12×12.5
	19	15	—	9 400	9 900	1 210	13 000	20 000	7E-HMK1215C	—	0.014	IR 9×12×16
	19	20	—	12 900	14 900	1 820	13 000	20 000	HMK1220CT	—	0.018	—
	19	25	—	15 300	18 600	2 260	13 000	20 000	HMK1225	—	0.023	—
13	19	12	—	6 950	7 900	965	12 000	18 000	HK1312FM	—	0.010	IR10×13×12.5
	19	12	2.7	6 950	7 900	965	12 000	18 000	—	BK1312	0.011	IR10×13×12.5
14	20	12	—	7 200	8 500	1 040	11 000	17 000	HK1412FM	—	0.011	IR10×14×13
	20	12	2.7	7 200	8 500	1 040	11 000	17 000	—	BK1412	0.012	IR10×14×13
	20	16	—	10 300	13 400	1 640	11 000	17 000	HK1416F	—	0.015	—
	20	16	2.7	10 300	13 400	1 640	11 000	17 000	—	BK1416CT	0.016	—
15	22	16	—	11 500	12 000	1 460	11 000	17 000	HMK1416C	—	0.019	IR10×14×20
	22	20	—	14 600	16 200	1 980	11 000	17 000	HMK1420C	—	0.024	—
	21	12	—	7 500	9 100	1 110	11 000	16 000	HK1512FM	—	0.011	IR12×15×12.5
	21	12	2.7	7 500	9 100	1 110	11 000	16 000	—	BK1512	0.013	IR12×15×12.5
15	21	16	—	10 700	14 400	1 750	11 000	16 000	HK1516F	—	0.015	IR12×15×16.5
	21	16	2.7	10 700	14 400	1 750	11 000	16 000	—	BK1516	0.017	IR12×15×16.5
	21	22	—	12 900	18 200	2 220	11 000	16 000	HK1522ZWF	—	0.020	IR12×15×22.5
	21	22	2.7	12 900	18 200	2 220	11 000	16 000	—	BK1522ZWD	0.022	IR12×15×22.5
	22	10	—	6 100	6 000	730	11 000	16 000	HMK1510	—	0.011	IR10×15×12.5
	22	12	—	7 950	8 450	1 030	11 000	16 000	HMK1512	—	0.013	IR12×15×12.5
15	22	15	—	10 500	12 100	1 480	11 000	16 000	HMK1515C	—	0.016	IR12×15×16
	22	20	—	15 300	19 700	2 400	11 000	16 000	HMK1520CV6	—	0.022	IR12×15×22.5
	22	25	—	18 500	25 000	3 050	11 000	16 000	HMK1525	—	0.027	—

1) If the bearing has an inner ring, the value indicates HK + IR.
Example: HK1312FM + IR10 × 13 × 12.5

Drawn cup needle roller bearings

HK type, HK · ZWD type
HMK type
BK type, BK · ZWD type

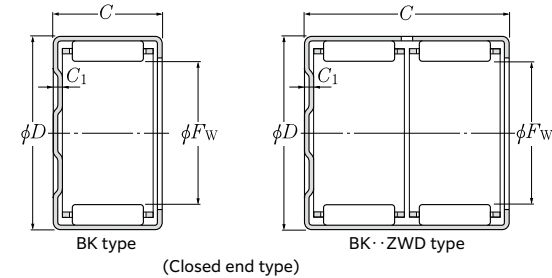
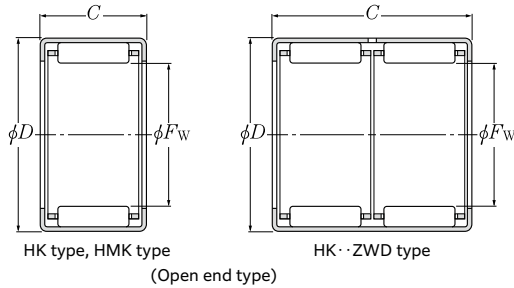

F_w 16 ~ 20mm

Boundary dimensions mm	Basic load rating		Fatigue load limit N C_{11}	Allowable speed		Number		Mass kg (approx.)	Applied inner ring ¹⁾ (approx.)			
	C_0	C_1		dynamic N C_T	static N C_{0r}	min ⁻¹ Grease lubrication	Oil lubrication			Open end type	Closed end type	
												F_w
16	22	12	—	7 750	9 700	1 180	10 000	15 000	HK1612FM	—	0.012	IR12×16×13
	22	12	2.7	7 750	9 700	1 180	10 000	15 000	—	BK1612	0.014	IR12×16×13
	22	16	—	11 100	15 300	1 870	10 000	15 000	HK1616F	—	0.016	IR12×16×20
	22	16	2.7	11 100	15 300	1 870	10 000	15 000	—	BK1616	0.018	IR12×16×20
	22	22	—	13 300	19 400	2 370	10 000	15 000	HK1622ZWFD	—	0.022	—
	22	22	2.7	13 300	19 400	2 370	10 000	15 000	—	BK1622ZWD	0.023	—
	24	16	—	12 400	13 500	1 640	10 000	15 000	HMK1616	—	0.021	IR12×16×20
	24	20	—	15 600	18 200	2 220	10 000	15 000	7E-HMK1620CT	—	0.027	IR12×16×22
17	23	12	—	8 050	10 300	1 260	9 500	14 000	HK1712FM	—	0.012	—
	23	12	2.7	8 050	10 300	1 260	9 500	14 000	—	BK1712CT	0.015	—
	24	15	—	11 600	14 200	1 740	9 500	14 000	7E-HMK1715CT	—	0.018	IR14×17×17
	24	20	—	15 200	20 000	2 440	9 500	14 000	7E-HMK1720CT	—	0.024	IR12×17×20.5
	24	25	—	19 000	26 700	3 250	9 500	14 000	7E-HMK1725CT	—	0.030	IR12×17×25.5
18	24	12	—	8 300	10 900	1 330	8 500	13 000	HK1812FM	—	0.013	IR15×18×12.5
	24	12	2.7	8 300	10 900	1 330	8 500	13 000	—	BK1812	0.015	IR15×18×12.5
	24	16	—	11 800	17 300	2 110	8 500	13 000	HK1816F	—	0.018	IR15×18×16.5
	24	16	2.7	11 800	17 300	2 110	8 500	13 000	—	BK1816	0.020	IR15×18×16.5
	25	13	—	10 200	12 200	1 480	8 500	13 000	HMK1813	—	0.016	IR15×18×16
	25	15	—	12 000	15 100	1 840	8 500	13 000	HMK1815	—	0.019	IR15×18×16
	25	17	—	13 300	17 200	2 100	8 500	13 000	HMK1817C	—	0.021	IR15×18×17.5
	25	19	—	15 500	20 900	2 540	8 500	13 000	HMK1819	—	0.024	IR15×18×20.5
	25	20	—	16 300	22 300	2 720	8 500	13 000	HMK1820	—	0.025	IR15×18×20.5
19	25	25	—	20 900	31 000	3 750	8 500	13 000	HMK1825V2	—	0.031	IR15×18×25.5
	27	16	—	13 900	16 300	2 000	8 500	13 000	HMK1916	—	0.025	IR15×19×20
	27	20	—	18 100	23 000	2 800	8 500	13 000	HMK1920F	—	0.031	—
20	26	12	—	8 750	12 100	1 480	8 000	12 000	HK2012FM	—	0.014	IR15×20×13
	26	12	2.7	9 250	13 000	1 590	8 000	12 000	—	BK2012	0.017	IR15×20×13
	26	16	—	12 500	19 200	2 340	8 000	12 000	HK2016F	—	0.019	IR17×20×16.5
	26	16	2.7	13 000	20 100	2 450	8 000	12 000	—	BK2016	0.022	IR17×20×16.5
	26	20	—	16 000	26 200	3 200	8 000	12 000	HK2020F	—	0.024	IR17×20×20.5

1) If the bearing has an inner ring, the value indicates HK + IR.
Example: HK1812FM + IR15 × 18 × 12.5

F_w 20 ~ 25mm

Boundary dimensions mm	Basic load rating		Fatigue load limit N C_{11}	Allowable speed		Number		Mass kg (approx.)	Applied inner ring ¹⁾ (approx.)				
	C_0	C_1		dynamic N C_T	static N C_{0r}	min ⁻¹ Grease lubrication	Oil lubrication			Open end type	Closed end type		
												F_w	D
20	26	20	2.7	16 000	26 200	3 200	8 000	12 000	—	BK2020CT	0.027	IR17×20×20.5	
	26	30	—	21 500	38 500	4 700	8 000	12 000	HK2030ZWF	—	0.035	IR17×20×30.5	
	26	30	2.7	22 200	40 000	4 900	8 000	12 000	—	BK2030ZWD	0.037	IR17×20×30.5	
	27	15	—	13 000	17 300	2 110	8 000	12 000	HMK2015CV3	—	0.021	IR17×20×16.5	
	27	20	—	17 200	24 800	3 000	8 000	12 000	HMK2020CT	—	0.027	IR17×20×20.5	
	27	25	—	22 000	34 000	4 150	8 000	12 000	HMK2025C	—	0.034	IR15×20×26	
	27	30	—	26 100	42 000	5 150	8 000	12 000	HMK2030	—	0.041	IR17×20×30.5	
	21	29	16	—	15 300	19 100	2 320	7 500	11 000	HMK2116	—	0.027	IR17×21×20
29		20	—	19 400	25 800	3 150	7 500	11 000	HMK2120	—	0.033	—	
22	28	12	—	9 200	13 400	1 630	7 500	11 000	HK2212FM	—	0.013	IR17×22×13	
	28	12	2.7	9 200	13 400	1 630	7 500	11 000	—	BK2212CT	0.015	IR17×22×13	
	28	16	—	13 200	21 100	2 570	7 500	11 000	HK2216F	—	0.021	IR17×22×18	
	28	16	2.7	13 600	22 100	2 700	7 500	11 000	—	BK2216	0.024	IR17×22×18	
	28	20	—	16 800	28 800	3 500	7 500	11 000	HK2220F	—	0.026	IR17×22×20.5	
	28	20	2.7	17 200	29 800	3 650	7 500	11 000	—	BK2220	0.030	IR17×22×20.5	
	29	10	—	8 400	10 100	1 240	7 500	11 000	HMK2210	—	0.015	IR17×22×13	
	29	15	—	12 900	17 600	2 150	7 500	11 000	7E-HMK2215C	—	0.022	IR17×22×16D	
	29	20	—	18 200	27 400	3 350	7 500	11 000	HMK2220CV2	—	0.030	IR17×22×20.5	
24	29	25	—	23 200	37 500	4 550	7 500	11 000	HMK2225CT	—	0.037	IR17×22×26	
	29	30	—	26 900	45 000	5 500	7 500	11 000	HMK2230	—	0.045	IR17×22×32	
	31	20	—	18 300	28 200	3 450	6 500	10 000	HMK2420CT	—	0.032	—	
	31	28	—	26 000	44 500	5 400	6 500	10 000	HMK2428	—	0.045	IR20×24×28.5	
	25	32	12	—	11 100	15 200	1 850	6 500	9 500	HK2512F	—	0.021	IR20×25×12.5
		32	12	2.7	11 800	16 300	1 990	6 500	9 500	—	BK2512	0.023	IR20×25×12.5
32		16	—	15 900	24 000	2 920	6 500	9 500	HK2516F	—	0.027	IR20×25×17	
32		16	2.7	15 900	24 000	2 920	6 500	9 500	—	BK2516	0.031	IR20×25×17	
32		20	—	20 300	33 000	4 000	6 500	9 500	HMK2520	—	0.034	IR20×25×20.5	
32		20	2.7	20 300	33 000	4 000	6 500	9 500	—	BK2520	0.039	IR20×25×20.5	
26	32	26	—	26 400	46 000	5 600	6 500	9 500	HK2526C	—	0.045	IR20×25×26.5	
	32	26	2.7	26 400	46 000	5 600	6 500	9 500	—	BK2526C	0.049	IR20×25×26.5	

1) If the bearing has an inner ring, the value indicates HK + IR.
Example: HK2512F + IR20 × 25 × 12.5

Drawn cup needle roller bearings

HK type, HK·ZWD type
HMK type, HMK·ZWD type
BK type, BK·ZWD type

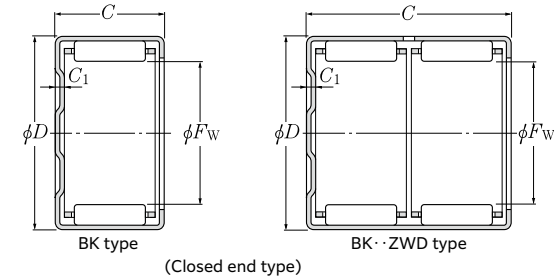
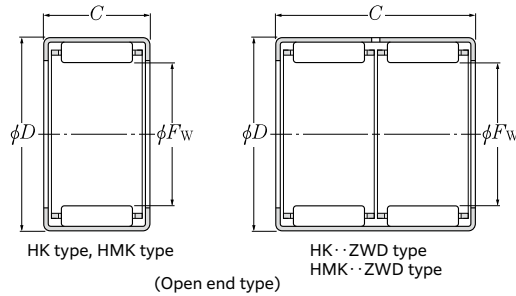

F_w 25 ~ 30mm

Boundary dimensions mm	Basic load rating		Fatigue load limit	Allowable speed		Number		Mass kg	Applied inner ring ¹⁾	
	dynamic	static		min ⁻¹		Open end type	Closed end type			
F_w D 0 Max.	C_T	C_{0r}	N	Grease lubrication	Oil lubrication			(approx.)	(approx.)	
25	32 38 —	35 000	65 500	8 000	6 500	9 500	HK2538ZWD	—	0.065	IR20×25×38.5
	32 38 2.7	35 000	65 500	8 000	6 500	9 500	—	BK2538ZWD	0.069	IR20×25×38.5
	33 10 —	9 150	10 400	1 270	6 500	9 500	HMK2510	—	0.019	IR20×25×12.5
	33 15 —	15 200	19 900	2 430	6 500	9 500	HMK2515CT	—	0.029	IR20×25×16
	33 20 —	21 200	30 500	3 750	6 500	9 500	HMK2520CT	—	0.039	IR20×25×20.5
	33 25 —	26 700	41 000	5 000	6 500	9 500	HMK2525F	—	0.048	IR20×25×26.5
26	33 30 —	32 000	52 000	6 350	6 500	9 500	7E-HMK2530C	—	0.058	IR20×25×32
	34 16 —	17 100	23 400	2 860	6 000	9 000	7E-HMK2616	—	0.032	IR22×26×20
	34 20 —	21 100	30 500	3 750	6 000	9 000	7E-HMK2620CT	—	0.040	—
28	35 16 —	16 700	26 400	3 200	5 500	8 500	HK2816CT	—	0.030	IR22×28×17
	35 16 2.7	16 700	26 400	3 200	5 500	8 500	—	BK2816CT	0.034	IR22×28×17
	35 20 —	21 300	36 000	4 400	5 500	8 500	HK2820	—	0.038	IR22×28×20.5
	35 20 2.7	21 300	36 000	4 400	5 500	8 500	—	BK2820	0.043	IR22×28×20.5
	37 20 —	23 600	32 500	4 000	5 500	8 500	HMK2820	—	0.049	IR22×28×20.5
29	37 30 —	35 000	54 500	6 600	5 500	8 500	7E-HMK2830C	—	0.073	—
	38 20 —	24 600	35 000	4 250	5 500	8 500	HMK2920	—	0.050	—
30	38 30 —	34 500	54 000	6 600	5 500	8 500	HMK2930	—	0.075	—
	37 12 —	12 300	18 200	2 220	5 500	8 000	HK3012CT	—	0.024	IR25×30×12.5
	37 12 2.7	12 300	18 200	2 220	5 500	8 000	—	BK3012CT	0.028	IR25×30×12.5
	37 16 —	18 100	30 000	3 650	5 500	8 000	7E-HK3016C	—	0.032	IR25×30×17
	37 16 2.7	18 100	30 000	3 650	5 500	8 000	—	BK3016CT	0.037	IR25×30×17
	37 20 —	22 300	39 500	4 800	5 500	8 000	HK3020F	—	0.040	IR25×30×20.5
	37 20 2.7	22 300	39 500	4 800	5 500	8 000	—	BK3020	0.047	IR25×30×20.5
	37 26 —	28 500	54 000	6 550	5 500	8 000	HK3026F	—	0.053	IR25×30×26.5
	37 26 2.7	28 500	54 000	6 550	5 500	8 000	—	7E-BK3026T	0.059	IR25×30×26.5
	37 38 —	38 500	78 500	9 600	5 500	8 000	HK3038ZWD	—	0.076	IR25×30×38.5
40	37 38 2.7	38 500	78 500	9 600	5 500	8 000	—	BK3038ZWD	0.083	IR25×30×38.5
40	40 13 —	14 100	17 100	2 090	5 500	8 000	HMK3013	—	0.040	IR25×30×16
	40 15 —	17 100	22 100	2 690	5 500	8 000	HMK3015	—	0.044	IR25×30×16
	40 20 —	24 200	34 500	4 200	5 500	8 000	HMK3020	—	0.058	IR25×30×20.5

1) If the bearing has an inner ring, the value indicates HK + IR.
Example: HK2820 + IR22 × 28 × 20.5

F_w 30 ~ 40mm

Boundary dimensions mm	Basic load rating		Fatigue load limit	Allowable speed		Number		Mass kg	Applied inner ring ¹⁾	
	dynamic	static		min ⁻¹		Open end type	Closed end type			
F_w D 0 Max.	C_T	C_{0r}	N	Grease lubrication	Oil lubrication			(approx.)	(approx.)	
30	40 25 —	31 000	47 500	5 800	5 500	8 000	7E-HMK3025CT	—	0.073	IR25×30×26.5
	40 30 —	36 000	57 500	7 000	5 500	8 000	HMK3030	—	0.087	IR25×30×32
32	42 20 —	27 500	38 000	4 600	5 000	7 500	7E-HMK3220	—	0.062	—
	42 30 —	41 500	64 500	7 850	5 000	7 500	7E-HMK3230	—	0.092	—
35	42 12 —	13 300	21 300	2 600	4 700	7 000	HK3512CV2	—	0.028	—
	42 12 2.7	13 300	21 300	2 600	4 700	7 000	—	BK3512CT	0.033	—
	42 16 —	19 000	33 500	4 100	4 700	7 000	HK3516CT	—	0.037	—
	42 16 2.7	19 000	33 500	4 100	4 700	7 000	—	BK3516CT	0.044	—
	42 20 —	24 800	47 500	5 800	4 700	7 000	HK3520	—	0.046	—
	42 20 2.7	24 800	47 500	5 800	4 700	7 000	—	BK3520	0.055	—
37	45 12 —	14 900	17 600	2 150	4 700	7 000	HMK3512	—	0.040	—
	45 15 —	20 200	26 200	3 200	4 700	7 000	HMK3515	—	0.050	—
	45 20 —	28 400	40 500	4 900	4 700	7 000	7E-HMK3520B	—	0.067	—
	45 25 —	36 000	54 500	6 650	4 700	7 000	HMK3525	—	0.083	—
	45 30 —	44 000	71 000	8 650	4 700	7 000	HMK3530CV1	—	0.100	—
38	47 20 —	29 300	43 000	5 250	4 300	6 500	HMK3720	—	0.070	—
	47 30 —	44 500	73 000	8 900	4 300	6 500	HMK3730	—	0.105	—
	48 15 —	21 700	29 300	3 550	4 300	6 500	HMK3815	—	0.054	—
	48 20 —	30 500	45 000	5 500	4 300	6 500	HMK3820	—	0.072	—
40	48 25 —	38 500	61 000	7 450	4 300	6 500	HMK3825	—	0.090	—
	48 30 —	46 000	77 000	9 400	4 300	6 500	HMK3830	—	0.107	IR32×38×32
	48 45 —	62 000	113 000	13 700	4 300	6 500	HMK3845ZWD	—	0.161	—
	47 12 —	12 100	19 500	2 380	4 000	6 000	HK4012V2	—	0.031	IR35×40×12.5
40	47 12 2.7	12 600	20 800	2 530	4 000	6 000	—	7E-BK4012CT	0.038	IR35×40×12.5
	47 16 —	20 300	38 500	4 700	4 000	6 000	HK4016CT	—	0.041	IR35×40×17
	47 16 2.7	20 300	38 500	4 700	4 000	6 000	—	BK4016CT	0.051	IR35×40×17
	47 20 —	25 900	52 500	6 400	4 000	6 000	HK4020F	—	0.052	IR35×40×20.5
	47 20 2.7	25 900	52 500	6 400	4 000	6 000	—	BK4020	0.064	IR35×40×20.5
	50 15 —	23 100	32 500	3 950	4 000	6 000	HMK4015	—	0.056	IR35×40×17
	50 20 —	32 500	50 000	6 100	4 000	6 000	7E-HMK4020	—	0.075	IR35×40×20.5

1) If the bearing has an inner ring, the value indicates HK + IR.
Example: HK4012 + IR35 × 40 × 12.5

Drawn cup needle roller bearings

HK type
HMK type, HMK · ZWD type
BK type

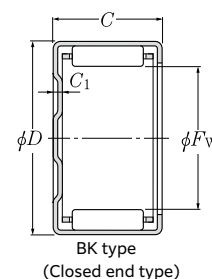
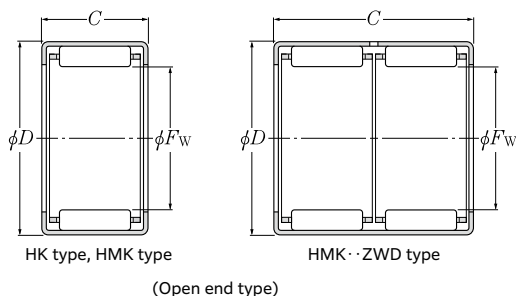

F_w 40 ~ 50mm

Boundary dimensions mm	Basic load rating	Fatigue load limit	Allowable speed		Number		Mass kg (approx.)	Applied inner ring ¹⁾ (approx.)
			dynamic	static	min ⁻¹			
F_w D	C_r C_{0r}	C_{11}	Grease lubrication	Oil lubrication				
50 25 —	41 000 67 500	8 250	4 000	6 000	7E-HMK4025	—	0.094	—
40 50 30 —	49 000 85 000	10 400	4 000	6 000	HMK4030	—	0.112	IR35×40×34
50 40 —	58 500 107 000	13 000	4 000	6 000	HMK4040ZWD	—	0.150	—
52 16 —	21 600 43 000	5 250	3 700	5 500	HK4516	—	0.046	IR40×45×17
52 16 2.7	21 600 43 000	5 250	3 700	5 500	—	BK4516	0.058	IR40×45×17
52 20 —	27 600 59 000	7 200	3 700	5 500	HK4520	—	0.058	IR40×45×20.5
52 20 2.7	27 600 59 000	7 200	3 700	5 500	—	BK4520	0.072	IR40×45×20.5
45 55 20 —	32 000 51 000	6 200	3 700	5 500	7E-HMK4520CT	—	0.083	IR40×45×20.5
55 25 —	41 500 71 500	8 700	3 700	5 500	HMK4525	—	0.104	IR40×45×26.5
55 30 —	49 500 90 000	11 000	3 700	5 500	7E-HMK4530CT	—	0.125	IR40×45×34
55 40 —	59 500 113 000	13 800	3 700	5 500	HMK4540ZWD	—	0.167	—
58 20 —	31 500 63 000	7 700	3 200	4 800	HK5020	—	0.072	IR40×50×22
58 20 2.7	31 500 63 000	7 700	3 200	4 800	—	BK5020	0.087	IR40×50×22
58 25 —	38 500 82 000	10 000	3 200	4 800	HK5025	—	0.090	IR45×50×25.5
58 25 2.7	38 500 82 000	10 000	3 200	4 800	—	BK5025	0.109	IR45×50×25.5
62 12 —	18 200 23 600	2 880	3 200	4 800	7E-HMK5012	—	0.067	—
50 62 15 —	25 900 37 000	4 550	3 200	4 800	7E-HMK5015	—	0.084	—
62 20 —	37 500 60 000	7 300	3 200	4 800	7E-HMK5020CT	—	0.112	IR40×50×22
62 25 —	48 000 82 500	10 100	3 200	4 800	7E-HMK5025	—	0.140	IR45×50×25.5
62 30 —	58 500 105 000	12 800	3 200	4 800	7E-HMK5030CPX1	—	0.168	IR45×50×32
62 40 —	70 000 134 000	16 300	3 200	4 800	7E-HMK5040ZWD	—	0.224	—
62 45 —	79 000 156 000	19 100	3 200	4 800	7E-HMK5045ZWCDPX1	—	0.252	—

1) If the bearing has an inner ring, the value indicates HK + IR.
Example: HK4516 + IR40 × 45 × 17

Needle Roller Bearings



Machined-ring needle roller bearings without an inner ring

RNA49 type
RNA59 type
RNA69 type
NK type

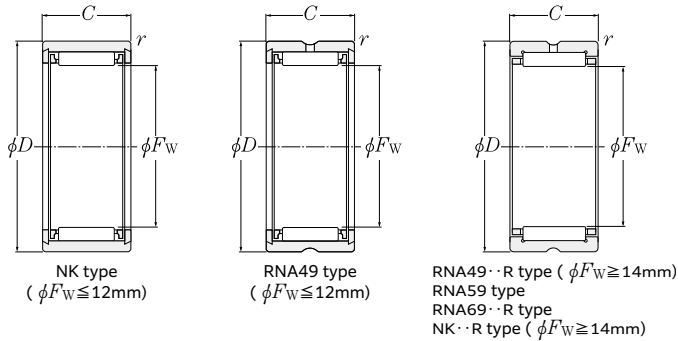

F_w 5 ~ 16mm

F_w	Boundary dimensions			Basic load rating		Fatigue load limit N C_u	Allowable speed		Number	Installation-related dimensions		Mass kg (approx.)
	mm	mm	r_s min ¹⁾	dynamic N C_r	static N C_{0r}		min ⁻¹	Oil lubrication		D_a Max.	$r_{as}^{(2)}$ Max.	
5	10	10	0.15	2 640	2 190	267	27 000	40 000	NK5/10T2	6.5	0.15	0.0031
		12	0.15	2 720	2 250	275	27 000	40 000	NK5/12T2	6.5	0.15	0.0037
6	12	10	0.15	2 660	2 280	278	25 000	37 000	NK6/10T2	7.5	0.15	0.0047
		12	0.15	3 400	3 150	380	25 000	37 000	NK6/12T2	7.5	0.15	0.0057
7	14	13	0.15	2 670	2 350	286	23 000	34 000	RNA495T2	8.5	0.15	0.0055
		10	0.3	2 670	2 350	286	23 000	34 000	NK7/10T2	8.5	0.3	0.0069
		12	0.3	3 400	3 200	390	23 000	34 000	NK7/12T2	8.5	0.3	0.0082
8	15	10	0.15	3 150	3 000	365	21 000	32 000	RNA496T2T	9.5	0.15	0.0073
		12	0.3	4 000	4 100	500	21 000	32 000	NK8/12T2	9.5	0.3	0.0087
		16	0.3	4 850	5 200	635	21 000	32 000	NK8/16	9.5	0.3	0.012
9	16	12	0.3	4 550	5 000	615	20 000	30 000	NK9/12T2	10.5	0.3	0.010
		16	0.3	5 500	6 400	780	20 000	30 000	NK9/16T2	10.5	0.3	0.013
		17	0.15	3 600	3 650	445	20 000	30 000	RNA497	10.5	0.15	0.0095
10	17	12	0.3	4 550	5 100	620	19 000	28 000	NK10/12T2	11.5	0.3	0.010
		16	0.3	5 450	6 450	790	19 000	28 000	8E-NK10/16CT	11.5	0.3	0.013
		11	0.15	5 250	5 150	630	19 000	28 000	RNA498CT	12	0.15	0.013
12	19	12	0.3	5 000	6 100	740	17 000	26 000	NK12/12	13.5	0.3	0.013
		16	0.3	6 000	7 700	940	17 000	26 000	NK12/16	13.5	0.3	0.016
		11	0.3	4 850	4 900	600	17 000	26 000	RNA499	14	0.3	0.013
14	22	13	0.3	8 600	9 200	1 120	16 000	24 000	RNA4900R	20	0.3	0.017
		16	0.3	10 300	11 500	1 400	16 000	24 000	NK14/16RCT	20	0.3	0.021
		20	0.3	13 000	15 600	1 900	16 000	24 000	NK14/20R	20	0.3	0.026
15	23	16	0.3	10 900	12 700	1 550	15 000	23 000	NK15/16R	21	0.3	0.022
		20	0.3	13 800	17 200	2 100	15 000	23 000	NK15/20R	21	0.3	0.027
16	24	13	0.3	9 550	10 900	1 330	15 000	23 000	RNA4901R	22	0.3	0.017
		16	0.3	12 200	14 900	1 820	15 000	23 000	NK16/16R	22	0.3	0.022
		20	0.3	14 600	18 800	2 290	15 000	23 000	NK16/20R	22	0.3	0.028
		22	0.3	15 400	20 000	2 440	15 000	23 000	RNA6901R	22	0.3	0.031

1) Smallest allowable dimension for chamfer dimension r .
2) Largest allowable dimension for fillet radius r_a of housing and shaft.

Needle Roller Bearings

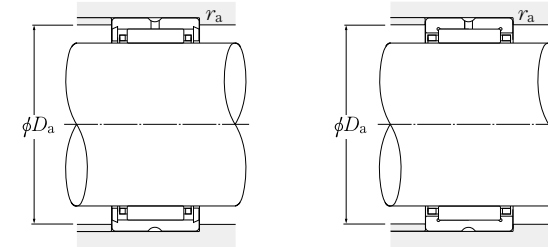

F_w 17 ~ 28mm

F_w	Boundary dimensions			Basic load rating		Fatigue load limit N C_u	Allowable speed		Number	Installation-related dimensions		Mass kg (approx.)
	mm	mm	r_s min ¹⁾	dynamic N C_r	static N C_{0r}		min ⁻¹	Oil lubrication		D_a Max.	$r_{as}^{(2)}$ Max.	
17	25	16	0.3	12 100	15 000	1 830	15 000	22 000	NK17/16R	23	0.3	0.024
		20	0.3	15 400	20 400	2 490	15 000	22 000	NK17/20R	23	0.3	0.030
18	26	16	0.3	12 700	16 200	1 980	14 000	21 000	NK18/16R	24	0.3	0.025
		20	0.3	16 100	22 000	2 690	14 000	21 000	NK18/20RCT	24	0.3	0.031
19	27	16	0.3	13 300	17 400	2 120	14 000	21 000	NK19/16R	25	0.3	0.026
		20	0.3	16 000	22 200	2 700	14 000	21 000	NK19/20R	25	0.3	0.032
20	28	13	0.3	10 300	12 800	1 560	13 000	20 000	RNA4902R	26	0.3	0.022
		16	0.3	13 200	17 500	2 140	13 000	20 000	NK20/16RCT	26	0.3	0.027
		18	0.3	14 100	19 100	2 330	13 000	20 000	RNA5902CT	26	0.3	0.033
		20	0.3	16 700	23 800	2 900	13 000	20 000	NK20/20R	26	0.3	0.034
		23	0.3	17 600	25 300	3 100	13 000	20 000	RNA6902R	26	0.3	0.040
21	29	16	0.3	13 700	18 700	2 280	13 000	19 000	NK21/16R	27	0.3	0.028
		20	0.3	17 400	25 400	3 100	13 000	19 000	NK21/20R	27	0.3	0.035
22	30	16	0.3	14 200	19 900	2 430	12 000	18 000	NK22/16R	28	0.3	0.034
		20	0.3	18 000	27 000	3 300	12 000	18 000	NK22/20R	28	0.3	0.037
		13	0.3	11 200	14 600	1 780	12 000	18 000	RNA4903R	28	0.3	0.022
		18	0.3	15 200	21 700	2 650	12 000	18 000	RNA5903	28	0.3	0.035
		23	0.3	18 200	27 200	3 300	12 000	18 000	RNA6903R	28	0.3	0.042
24	32	16	0.3	15 200	22 300	2 720	11 000	17 000	NK24/16R	30	0.3	0.032
		20	0.3	18 600	28 800	3 500	11 000	17 000	NK24/20R	30	0.3	0.040
25	33	16	0.3	15 100	22 400	2 730	11 000	16 000	NK25/16R	31	0.3	0.033
		20	0.3	19 200	30 500	3 700	11 000	16 000	NK25/20RCT	31	0.3	0.042
		17	0.3	21 300	25 500	3 100	11 000	16 000	RNA4904RCT	35	0.3	0.052
		23	0.3	28 400	37 000	4 500	11 000	16 000	RNA5904	35	0.3	0.084
		30	0.3	36 500	50 500	6 150	11 000	16 000	RNA6904R	35	0.3	0.100
26	34	16	0.3	15 600	23 600	2 880	10 000	15 000	8E-NK26/16RCT	32	0.3	0.034
		20	0.3	19 100	30 500	3 700	10 000	15 000	NK26/20R	32	0.3	0.042
28	37	20	0.3	22 300	34 000	4 150	9 500	14 000	NK28/20R	35	0.3	0.052
		30	0.3	26 700	48 000	5 850	9 500	14 000	NK28/30RCT	35	0.3	0.082

1) Smallest allowable dimension for chamfer dimension r .
2) Largest allowable dimension for fillet radius r_a of housing and shaft.

Needle Roller Bearings



Machined-ring needle roller bearings without an inner ring

RNA49 type
RNA59 type
RNA69 type
NK type

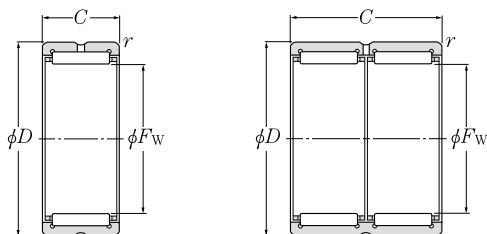

RNA49 · R type, RNA59 type
RNA69 · R type ($\phi F_w \leq 35\text{mm}$)
NK · R type

RNA69 type · R type
($\phi F_w \geq 40\text{mm}$)

F_w 28 ~ 40mm

F_w	Boundary dimensions			Basic load rating		Fatigue load limit N C_u	Allowable speed		Number	Installation-related dimensions mm		Mass kg (approx.)	
	mm	mm	r_s min ⁻¹	dynamic C_r	static C_{0r}		min ⁻¹	Oil lubrication		D_a Max.	$r_{as}^{(2)}$ Max.		
28	+0.033 +0.020	39	17	0.3	23 200	29 300	3 600	9 500	14 000	RNA49/22R	37	0.3	0.050
		39	23	0.3	26 400	37 500	4 600	9 500	14 000	RNA59/22	37	0.3	0.092
		39	30	0.3	40 000	58 500	7 150	9 500	14 000	RNA69/22R	37	0.3	0.100
29	+0.033 +0.020	38	20	0.3	22 200	34 000	4 150	9 500	14 000	NK29/20R	36	0.3	0.054
		38	30	0.3	27 500	50 500	6 150	9 500	14 000	NK29/30R	36	0.3	0.084
30	+0.033 +0.020	40	20	0.3	22 100	34 000	4 150	8 500	13 000	NK30/20R	38	0.3	0.065
		40	30	0.3	33 000	57 000	6 950	8 500	13 000	NK30/30R	38	0.3	0.098
		42	17	0.3	24 000	31 500	3 800	8 500	13 000	RNA4905R	40	0.3	0.061
		42	23	0.3	30 500	43 000	5 200	8 500	13 000	RNA5905	40	0.3	0.101
32	+0.041 +0.025	42	20	0.3	23 500	37 500	4 600	8 500	13 000	NK32/20R	40	0.3	0.068
		42	30	0.3	34 000	60 500	7 350	8 500	13 000	NK32/30R	40	0.3	0.102
		45	17	0.3	24 800	33 500	4 050	8 500	13 000	RNA49/28RCT	43	0.3	0.073
		45	23	0.3	32 000	45 500	5 550	8 500	13 000	RNA59/28	43	0.3	0.108
35	+0.041 +0.025	45	20	0.3	24 800	41 500	5 050	7 500	11 000	NK35/20RCT	43	0.3	0.074
		45	30	0.3	36 000	66 500	8 100	7 500	11 000	NK35/30R	43	0.3	0.112
		47	17	0.3	25 500	35 500	4 300	7 500	11 000	RNA4906R	45	0.3	0.069
		47	23	0.3	32 500	48 500	5 950	7 500	11 000	RNA5906	45	0.3	0.108
37	+0.041 +0.025	47	20	0.3	25 300	43 500	5 300	7 500	11 000	NK37/20R	45	0.3	0.077
		47	30	0.3	36 500	69 500	8 500	7 500	11 000	NK37/30R	45	0.3	0.107
38	+0.041 +0.025	48	20	0.3	25 900	45 000	5 500	7 500	11 000	NK38/20R	46	0.3	0.079
		48	30	0.3	37 500	73 000	8 900	7 500	11 000	NK38/30R	46	0.3	0.107
40	+0.041 +0.025	50	20	0.3	26 400	47 000	5 750	6 500	10 000	NK40/20R	48	0.3	0.083
		50	30	0.3	38 500	76 000	9 250	6 500	10 000	NK40/30R	48	0.3	0.125
		52	20	0.6	31 500	47 500	5 800	6 500	10 000	RNA49/32R	48	0.6	0.089
		52	27	0.6	38 000	61 000	7 450	6 500	10 000	RNA59/32	48	0.6	0.149
									RNA69/32R	48	0.6	0.162	

1) Smallest allowable dimension for chamfer dimension r .
2) Largest allowable dimension for fillet radius r_a of housing and shaft.

Needle Roller Bearings

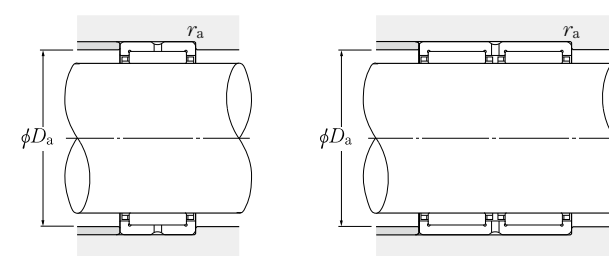

F_w 42 ~ 63mm

F_w	Boundary dimensions			Basic load rating		Fatigue load limit N C_u	Allowable speed		Number	Installation-related dimensions mm		Mass kg (approx.)	
	mm	mm	r_s min ⁻¹	dynamic C_r	static C_{0r}		min ⁻¹	Oil lubrication		D_a Max.	$r_{as}^{(2)}$ Max.		
42	+0.041 +0.025	52	20	0.3	26 900	49 000	5 950	6 500	9 500	NK42/20R	50	0.3	0.086
		52	30	0.3	39 000	79 000	9 650	6 500	9 500	NK42/30R	50	0.3	0.130
		55	20	0.6	32 000	50 000	6 100	6 500	9 500	RNA4907R	51	0.6	0.107
43	+0.041 +0.025	55	27	0.6	39 000	64 500	7 850	6 500	9 500	RNA5907	51	0.6	0.176
		55	36	0.6	49 000	86 500	10 500	6 500	9 500	RNA6907R	51	0.6	0.193
		53	20	0.3	27 500	51 000	6 200	6 500	9 500	NK43/20R	51	0.3	0.086
45	+0.041 +0.025	53	30	0.3	40 000	82 000	10 000	6 500	9 500	NK43/30R	51	0.3	0.133
		55	20	0.3	28 000	52 500	6 450	6 000	9 000	NK45/20R	53	0.3	0.092
47	+0.041 +0.025	55	30	0.3	41 000	85 500	10 400	6 000	9 000	NK45/30RCT	53	0.3	0.139
		57	20	0.3	28 800	55 500	6 800	5 500	8 500	NK47/20RCT	55	0.3	0.095
48	+0.041 +0.025	57	30	0.3	42 500	91 500	11 200	5 500	8 500	NK47/30R	55	0.3	0.142
		62	22	0.6	43 500	66 500	8 150	5 500	8 500	RNA4908R	58	0.6	0.140
		62	30	0.6	53 000	92 500	11 300	5 500	8 500	RNA5908	58	0.6	0.225
50	+0.041 +0.025	62	40	0.6	67 000	116 000	14 100	5 500	8 500	RNA6908R	58	0.6	0.256
		62	25	0.6	38 500	74 500	9 050	5 500	8 000	NK50/25RCT	58	0.6	0.158
52	+0.049 +0.030	62	35	0.6	51 000	106 000	12 900	5 500	8 000	NK50/35R	58	0.6	0.221
		68	22	0.6	46 000	73 000	8 950	5 000	7 500	RNA4909R	64	0.6	0.182
55	+0.049 +0.030	68	30	0.6	56 000	101 000	12 300	5 000	7 500	RNA5909	64	0.6	0.232
		68	40	0.6	70 500	127 000	15 500	5 000	7 500	RNA6909R	64	0.6	0.273
		68	25	0.6	41 000	82 000	10 000	5 000	7 500	NK55/25R	64	0.6	0.193
58	+0.049 +0.030	68	35	0.6	54 000	118 000	14 300	5 000	7 500	NK55/35R	64	0.6	0.26
		72	22	0.6	48 000	80 000	9 750	4 700	7 000	RNA4910R	68	0.6	0.163
		72	30	0.6	58 000	110 000	13 400	4 700	7 000	RNA5910	68	0.6	0.289
60	+0.049 +0.030	72	40	0.6	74 000	139 000	17 000	4 700	7 000	RNA6910R	68	0.6	0.320
		72	25	0.6	41 000	85 000	10 400	4 300	6 500	NK60/25R	68	0.6	0.185
63	+0.049 +0.030	72	35	0.6	57 000	130 000	15 800	4 300	6 500	NK60/35R	68	0.6	0.258
		80	25	1	58 500	99 500	12 100	4 300	6 500	RNA4911R	75	1	0.255
63	+0.049 +0.030	80	34	1	76 500	140 000	17 100	4 300	6 500	RNA5911	75	1	0.367
		80	45	1	94 000	183 000	22 300	4 300	6 500	RNA6911R	75	1	0.470

1) Smallest allowable dimension for chamfer dimension r .
2) Largest allowable dimension for fillet radius r_a of housing and shaft.

Needle Roller Bearings



Machined-ring needle roller bearings without an inner ring

RNA49 type
RNA59 type
RNA69 type
NK type

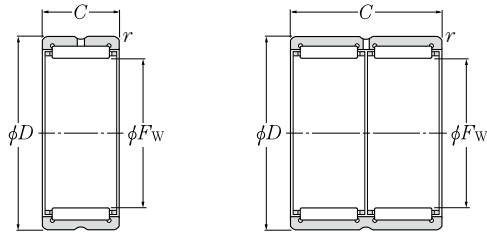

RNA48 type
RNA49·R type
RNA59 type
NK·R type

F_w 65 ~ 90mm

Boundary dimensions	Basic load rating			Fatigue load limit	Allowable speed		Number	Installation-related dimensions		Mass			
	mm				dynamic	static		min ⁻¹	mm		kg		
F_w	D	C	r_s min ¹⁾	C_r	N	C_{0r}	Grease lubrication	Oil lubrication	D_a Max.	$r_{as}^{2)}$ Max.	(approx.)		
65	^{+0.049} _{+0.030}	78	25	0.6	45 000	98 000	12 000	4 000	6 000	NK65/25R	74	0.6	0.221
		78	35	0.6	60 000	142 000	17 300	4 000	6 000	NK65/35R	74	0.6	0.310
68		82	25	1	44 500	89 000	10 800	4 000	6 000	NK68/25R	77	0.6	0.241
		82	35	0.6	63 000	139 000	17 000	4 000	6 000	NK68/35R	78	0.6	0.338
	^{+0.049} _{+0.030}	85	25	1	61 500	108 000	13 100	4 000	6 000	RNA4912R	80	1	0.275
		85	34	1	80 500	153 000	18 600	4 000	6 000	RNA5912	80	1	0.408
70	^{+0.049} _{+0.030}	85	25	0.6	45 000	91 500	11 200	3 700	5 500	NK70/25R	81	0.6	0.275
		85	35	0.6	64 000	144 000	17 600	3 700	5 500	NK70/35R	81	0.6	0.386
72	^{+0.049} _{+0.030}	90	25	1	62 500	112 000	13 700	3 700	5 500	RNA4913R	85	1	0.312
		90	34	1	84 000	165 000	20 100	3 700	5 500	RNA5913	85	1	0.462
		90	45	1	97 000	198 000	24 200	3 700	5 500	RNA6913R	85	1	0.520
73	^{+0.049} _{+0.030}	90	25	0.6	54 000	100 000	12 200	3 700	5 500	NK73/25R	86	0.6	0.302
		90	35	0.6	76 500	156 000	19 100	3 700	5 500	NK73/35R	86	0.6	0.428
75	^{+0.049} _{+0.030}	92	25	0.6	55 000	104 000	12 600	3 700	5 500	NK75/25R	88	0.6	0.315
		92	35	0.6	78 000	162 000	19 800	3 700	5 500	NK75/35R	88	0.6	0.492
80		95	25	1	57 000	119 000	14 500	3 300	5 000	NK80/25R	90	1	0.301
		95	35	1	79 500	184 000	22 400	3 300	5 000	NK80/35R	90	1	0.425
	^{+0.049} _{+0.030}	100	30	1	85 500	156 000	19 000	3 300	5 000	RNA4914R	95	1	0.460
		100	40	1	103 000	187 000	22 800	3 300	5 000	RNA5914	95	1	0.706
		100	54	1	130 000	267 000	32 500	3 300	5 000	RNA6914R	95	1	0.857
85		105	25	1	70 500	123 000	15 000	3 100	4 700	NK85/25R	100	1	0.404
		105	30	1	87 000	162 000	19 700	3 100	4 700	RNA4915R	100	1	0.489
	^{+0.058} _{+0.036}	105	35	1	100 000	193 000	23 600	3 100	4 700	NK85/35R	100	1	0.517
		105	40	1	109 000	205 000	25 000	3 100	4 700	RNA5915	100	1	0.745
		105	54	1	132 000	277 000	34 000	3 100	4 700	RNA6915R	100	1	0.935
90	^{+0.058} _{+0.036}	110	25	1	71 500	128 000	15 600	2 900	4 400	NK90/25R	105	1	0.426
		110	30	1	90 500	174 000	21 200	2 900	4 400	RNA4916R	105	1	0.516
		110	35	1	104 000	208 000	25 400	2 900	4 400	NK90/35R	105	1	0.604

1) Smallest allowable dimension for chamfer dimension r .
2) Largest allowable dimension for fillet radius r_a of housing and shaft.

Needle Roller Bearings

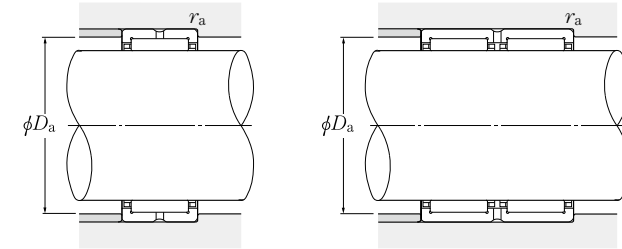

F_w 90 ~ 135mm

Boundary dimensions	Basic load rating			Fatigue load limit	Allowable speed		Number	Installation-related dimensions		Mass			
	mm				dynamic	static		min ⁻¹	mm		kg		
F_w	D	C	r_s min ¹⁾	C_r	N	C_{0r}	Grease lubrication	Oil lubrication	D_a Max.	$r_{as}^{2)}$ Max.	(approx.)		
90	^{+0.058} _{+0.036}	110	40	1	115 000	223 000	27 200	2 900	4 400	RNA5916	105	1	0.787
		110	54	1	138 000	298 000	36 500	2 900	4 400	RNA6916R	105	1	0.987
95	^{+0.058} _{+0.036}	115	26	1	74 500	137 000	16 600	2 800	4 200	NK95/26R	110	1	0.364
		115	36	1	108 000	223 000	27 000	2 800	4 200	NK95/36R	110	1	0.652
100		120	26	1	73 500	137 000	16 500	2 700	4 000	NK100/26R	115	1	0.487
		120	35	1.1	112 000	237 000	28 400	2 700	4 000	RNA4917R	113.5	1	0.657
	^{+0.058} _{+0.036}	120	36	1	107 000	223 000	26 700	2 700	4 000	NK100/36R	115	1	0.679
		120	46	1.1	137 000	290 000	34 500	2 700	4 000	RNA5917	113.5	1	1.00
105		120	63	1.1	169 000	400 000	48 000	2 700	4 000	RNA6917R	113.5	1	1.20
		125	26	1	76 500	147 000	17 300	2 500	3 800	NK105/26R	120	1	0.506
		125	35	1.1	116 000	252 000	29 800	2 500	3 800	RNA4918R	118.5	1	0.697
	^{+0.058} _{+0.036}	125	36	1	111 000	238 000	28 100	2 500	3 800	NK105/36R	120	1	0.713
		125	46	1.1	143 000	310 000	37 000	2 500	3 800	RNA5918	118.5	1	1.04
110		125	63	1.1	175 000	425 000	50 500	2 500	3 800	RNA6918R	118.5	1	1.33
		130	30	1.1	97 500	204 000	23 800	2 400	3 600	NK110/30R	123.5	1	0.612
	^{+0.058} _{+0.036}	130	35	1.1	118 000	260 000	30 500	2 400	3 600	RNA4919R	123.5	1	0.719
		130	40	1.1	129 000	292 000	34 000	2 400	3 600	NK110/40R	123.5	1	0.830
115		130	46	1.1	149 000	335 000	39 000	2 400	3 600	RNA5919	123.5	1	1.13
		130	63	1.1	177 000	440 000	51 000	2 400	3 600	RNA6919R	123.5	1	1.46
	^{+0.058} _{+0.036}	140	40	1.1	127 000	260 000	29 900	2 300	3 500	RNA4920	133.5	1	1.15
120		140	54	1.1	182 000	395 000	45 500	2 300	3 500	RNA5920	133.5	1	1.76
	^{+0.058} _{+0.036}	140	30	1	93 500	210 000	23 900	2 200	3 300	RNA4822	135	1	0.670
125		140	40	1.1	113 000	268 000	30 500	2 200	3 300	NK120/40	133.5	1	0.910
	^{+0.068} _{+0.043}	150	40	1.1	131 000	279 000	31 500	2 100	3 200	RNA4922	143.5	1	1.24
130		150	54	1.1	193 000	440 000	49 500	2 100	3 200	RNA5922	143.5	1	1.89
	^{+0.068} _{+0.043}	150	30	1	99 500	233 000	25 900	2 100	3 100	RNA4824	145	1	0.730
135		150	40	1.1	116 000	283 000	31 500	2 100	3 100	NK130/40	143.5	1	0.980
	^{+0.068} _{+0.043}	165	45	1.1	180 000	380 000	41 500	2 000	3 000	RNA4924	158.5	1	1.86
	165	60	1.1	246 000	530 000	57 500	2 000	3 000	RNA5924	158.5	1	2.67	

1) Smallest allowable dimension for chamfer dimension r .
2) Largest allowable dimension for fillet radius r_a of housing and shaft.

Needle Roller Bearings



Machined-ring needle roller bearings without an inner ring

- RNA48 type
- RNA49 type
- RNA59 type
- RNA69 type
- NK type

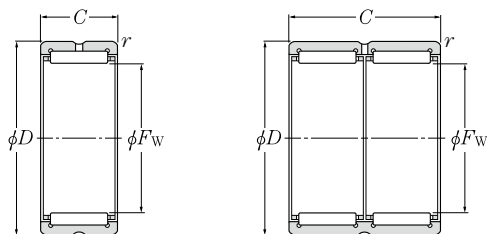

RNA48 type
RNA49·R type, RNA49 type
RNA59 type
NK·R type, NK type

RNA69·R type

F_w 145 ~ 245mm

F_w	Boundary dimensions			Basic load rating		Fatigue load limit N C_u	Allowable speed		Number	Installation-related dimensions		Mass kg (approx.)
	mm	mm	r_s min ⁻¹	dynamic N C_r	static N C_{0r}		min ⁻¹	Oil lubrication		D_a Max.	$r_{as}^{(2)}$ Max.	
145 ^{+0.068/+0.043}	165	35	1.1	118 000	305 000	32 500	1 900	2 800	RNA4826	158.5	1	0.95
	170	32	1.5	111 000	238 000	25 600	1 900	2 800	NK145/32	162.5	1.5	1.12
	170	42	1.5	153 000	360 000	38 500	1 900	2 800	NK145/42	162.5	1.5	1.49
150 ^{+0.068/+0.043}	180	50	1.5	202 000	455 000	48 000	1 800	2 700	RNA4926	172	1.5	2.21
	180	67	1.5	296 000	690 000	73 000	1 800	2 700	RNA5926	172	1.5	3.21
155 ^{+0.068/+0.043}	175	35	1.1	121 000	315 000	33 500	1 700	2 600	RNA4828	168.5	1	1.02
	180	32	1.5	114 000	252 000	26 500	1 700	2 600	NK155/32	172	1.5	1.20
	180	42	1.5	156 000	380 000	40 000	1 700	2 600	NK155/42	172	1.5	1.59
160 ^{+0.068/+0.043}	190	50	1.5	209 000	485 000	50 500	1 700	2 500	RNA4928	182	1.5	2.35
	190	67	1.5	315 000	760 000	79 000	1 700	2 500	RNA5928	182	1.5	3.48
165 ^{+0.068/+0.043}	190	32	1.5	117 000	265 000	27 400	1 600	2 400	NK165/32	182	1.5	1.42
	190	40	1.1	152 000	390 000	40 500	1 600	2 400	RNA4830	183.5	1	1.60
	190	42	1.5	160 000	400 000	41 000	1 600	2 400	NK165/42	182	1.5	1.66
170 ^{+0.068/+0.043}	210	60	2	261 000	610 000	62 500	1 600	2 400	RNA4930	201	2	2.98
175 ^{+0.068/+0.043}	200	40	1.1	160 000	425 000	43 500	1 500	2 300	RNA4832	193.5	1	1.70
180 ^{+0.068/+0.043}	220	60	2	270 000	650 000	65 500	1 500	2 200	RNA4932	211	2	3.10
185 ^{+0.079/+0.050}	215	45	1.1	185 000	495 000	49 500	1 500	2 200	RNA4834	208.5	1	2.54
190 ^{+0.079/+0.050}	230	60	2	279 000	690 000	68 500	1 400	2 100	RNA4934	221	2	3.22
195 ^{+0.079/+0.050}	225	45	1.1	195 000	540 000	53 500	1 400	2 100	RNA4836	218.5	1	2.68
205 ^{+0.079/+0.050}	250	69	2	375 000	890 000	86 000	1 300	2 000	RNA4936	241	2	4.48
210 ^{+0.079/+0.050}	240	50	1.5	227 000	680 000	65 500	1 300	1 900	RNA4838	232	1.5	3.21
215 ^{+0.079/+0.050}	260	69	2	390 000	945 000	90 500	1 300	1 900	RNA4938	251	2	4.53
220 ^{+0.079/+0.050}	250	50	1.5	231 000	705 000	67 000	1 200	1 800	RNA4840	242	1.5	3.35
225 ^{+0.079/+0.050}	280	80	2.1	505 000	1 180 000	111 000	1 200	1 800	RNA4940	269	2	7.20
240 ^{+0.079/+0.050}	270	50	1.5	244 000	780 000	72 500	1 100	1 700	RNA4844	262	1.5	3.62
245 ^{+0.079/+0.050}	300	80	2.1	525 000	1 270 000	116 000	1 100	1 600	RNA4944	289	2	7.81

1) Smallest allowable dimension for chamfer dimension r .
2) Largest allowable dimension for fillet radius r_a of housing and shaft.

Needle Roller Bearings

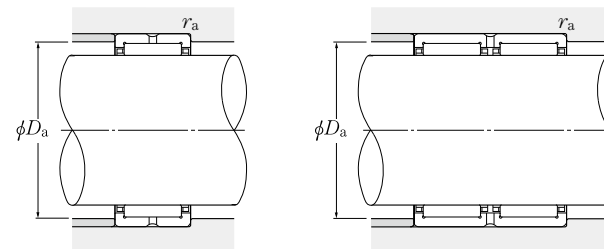

F_w 265 ~ 490mm

F_w	Boundary dimensions			Basic load rating		Fatigue load limit N C_u	Allowable speed		Number	Installation-related dimensions		Mass kg (approx.)
	mm	mm	r_s min ⁻¹	dynamic N C_r	static N C_{0r}		min ⁻¹	Oil lubrication		D_a Max.	$r_{as}^{(2)}$ Max.	
265 ^{+0.088/+0.056}	300	60	2	365 000	1 090 000	98 500	1 000	1 500	RNA4848	291	2	5.40
	320	80	2.1	540 000	1 350 000	121 000	1 000	1 500	RNA4948	309	2	8.40
285 ^{+0.088/+0.056}	320	60	2	375 000	1 170 000	103 000	950	1 400	RNA4852	311	2	5.80
290 ^{+0.088/+0.056}	360	100	2.1	810 000	1 920 000	166 000	950	1 400	RNA4952	349	2	15.9
305 ^{+0.088/+0.056}	350	69	2	455 000	1 300 000	112 000	850	1 300	RNA4856	341	2	9.30
310 ^{+0.088/+0.056}	380	100	2.1	840 000	2 050 000	175 000	850	1 300	RNA4956	369	2	16.7
330 ^{+0.098/+0.062}	380	80	2.1	625 000	1 770 000	149 000	800	1 200	RNA4860	369	2	12.7
340 ^{+0.098/+0.062}	420	118	3	1 080 000	2 640 000	219 000	800	1 200	RNA4960	407	2.5	24.0
350 ^{+0.098/+0.062}	400	80	2.1	640 000	1 850 000	153 000	750	1 100	RNA4864	389	2	13.4
360 ^{+0.098/+0.062}	440	118	3	1 120 000	2 820 000	230 000	750	1 100	RNA4964	427	2.5	25.2
370 ^{+0.098/+0.062}	420	80	2.1	655 000	1 940 000	158 000	750	1 100	RNA4868	409	2	14.0
380 ^{+0.098/+0.062}	460	118	3	1 160 000	3 000 000	242 000	750	1 100	RNA4968	447	2.5	26.5
390 ^{+0.098/+0.062}	440	80	2.1	665 000	2 020 000	162 000	650	1 000	RNA4872	429	2	14.8
400 ^{+0.108/+0.068}	480	118	3	1 200 000	3 200 000	253 000	650	1 000	RNA4972	467	2.5	28.2
415 ^{+0.108/+0.068}	480	100	2.1	1 000 000	2 840 000	223 000	650	950	RNA4876	469	2	26.0
430 ^{+0.108/+0.068}	520	140	4	1 400 000	3 750 000	292 000	650	950	RNA4976	504	3	38.6
450 ^{+0.108/+0.068}	540	140	4	1 450 000	4 000 000	306 000	600	900	RNA4980	524	3	40.1
470 ^{+0.108/+0.068}	560	140	4	1 500 000	4 250 000	320 000	550	850	RNA4984	544	3	51.6
490 ^{+0.108/+0.068}	600	160	4	1 750 000	4 600 000	342 000	550	800	RNA4988	584	3	66.9

1) Smallest allowable dimension for chamfer dimension r .
2) Largest allowable dimension for fillet radius r_a of housing and shaft.

Needle Roller Bearings



Machined-ring needle roller bearings with an inner ring

NA49 type
NA59 type
NA69 type
NK+IR type

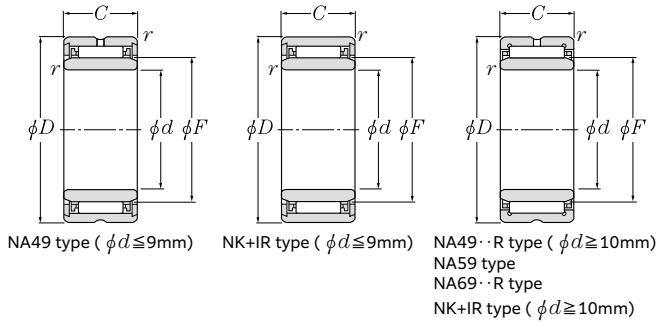

d 5 ~ 17mm

Boundary dimensions mm	Basic load rating		Fatigue load limit N C_U	Allowable speed		Number					
	dynamic C_T	static C_{0r}		min ⁻¹ Grease lubrication	Oil lubrication						
5	13	10	0.15	7	—	2 670	2 350	287	23 000	34 000	NA495T2
	15	12	0.3	8	1.5	4 000	4 100	500	21 000	32 000	NK8/12T2+IR5×8×12
	15	16	0.3	8	2	4 850	5 200	635	21 000	32 000	NK8/16T2+IR5×8×16
6	15	10	0.15	8	—	3 150	3 000	365	21 000	32 000	NA496T2T
	16	12	0.3	9	1.5	4 550	5 000	615	20 000	30 000	NK9/12T2+IR6×9×12
	16	16	0.3	9	2	5 500	6 400	780	20 000	30 000	NK9/16T2+IR6×9×16
7	17	10	0.15	9	—	3 600	3 650	445	20 000	30 000	NA497
	17	12	0.3	10	1.5	4 550	5 100	620	19 000	28 000	NK10/12T2+IR7×10×12
	17	16	0.3	10	2	5 450	6 450	790	19 000	28 000	8E-NK10/16CT+IR7×10×16
8	19	11	0.15	10	—	5 250	5 150	630	19 000	28 000	NA498CT
	19	12	0.3	12	1.5	5 000	6 100	740	17 000	26 000	NK12/12+IR9×12×12
9	19	16	0.3	12	2	6 000	7 700	940	17 000	26 000	NK12/16+IR9×12×16
	20	11	0.3	12	—	4 850	4 900	595	17 000	26 000	NA499
10	22	13	0.3	14	0.5	8 600	9 200	1 120	16 000	24 000	NA4900R
	22	16	0.3	14	0.5	10 300	11 500	1 400	16 000	24 000	NK14/16RCT+IR10×14×16
	22	20	0.3	14	0.5	13 000	15 600	1 900	16 000	24 000	NK14/20R+IR10×14×20
12	24	13	0.3	16	0.5	9 550	10 900	1 330	15 000	23 000	NA4901R
	24	16	0.3	16	0.5	12 200	14 900	1 820	15 000	23 000	NK16/16R+IR12×16×16
	24	20	0.3	16	0.5	14 600	18 800	2 290	15 000	23 000	NK16/20R+IR12×16×20
	24	22	0.3	16	1	15 400	20 000	2 440	15 000	23 000	NA6901R
15	27	16	0.3	19	0.5	13 300	17 400	2 120	14 000	21 000	NK19/16R+IR15×19×16
	27	20	0.3	19	0.5	16 000	22 200	2 700	14 000	21 000	NK19/20R+IR15×19×20
	28	13	0.3	20	0.5	10 300	12 800	1 560	13 000	20 000	NA4902R
	28	18	0.3	20	0.5	14 100	19 100	2 330	13 000	20 000	NA5902CT
	28	23	0.3	20	1	17 600	25 300	3 100	13 000	20 000	NA6902R
17	29	16	0.3	21	0.5	13 700	18 700	2 280	13 000	19 000	NK21/16R+IR17×21×16
	29	20	0.3	21	0.5	17 400	25 400	3 100	13 000	19 000	NK21/20R+IR17×21×20
	30	13	0.3	22	0.5	11 200	14 600	1 780	12 000	18 000	NA4903R

1) Smallest allowable dimension for chamfer dimension r .
2) Allowable axial movement amount of the inner ring with respect to the outer ring.
3) Largest allowable dimension for fillet radius r_a of housing and shaft.

Needle Roller Bearings

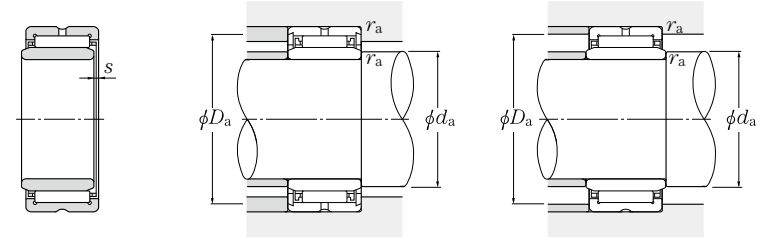

Installation-related dimensions mm	Mass	
	kg	(approx.)
d_a Min.	6.2	0.007
D_a Max.	8.5	0.012
r_{as} Max.	0.15	0.016
	7	0.009
	9.5	0.013
	0.3	0.017
	8	0.010
	10.5	0.014
	0.3	0.018
	8	0.017
	10.5	0.010
	0.3	0.014
	9	0.018
	11.5	0.022
	0.3	0.017
	11	0.018
	13.5	0.022
	0.3	0.017
	11	0.024
	13.5	0.030
	0.3	0.038
	12	0.026
	20	0.033
	0.3	0.042
	14	0.046
	22	0.039
	0.3	0.045
	17	0.036
	25	0.052
	0.3	0.064
	17	0.042
	26	0.053
	0.3	0.037
	19	
	27	
	0.3	
	19	
	27	
	0.3	
	19	
	28	
	0.3	

Note: The number of inner rings (IR) is composed of the IR inner diameter dimension × outer diameter dimension × width dimension.

Machined-ring needle roller bearings with an inner ring

NA49 type
NA59 type
NA69 type
NK+IR type

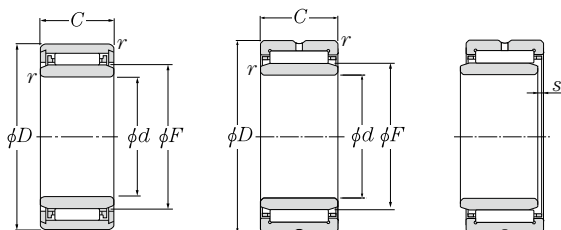

NA49··R type
NA59 type
NA69··R type
NK··R+IR type

d 17 ~ 32mm

Boundary dimensions						Basic load rating		Fatigue load limit	Allowable speed		Number
mm						dynamic	static		min ⁻¹		
d	D	C	r _{s min} ¹⁾	F	s ²⁾	C _r	C _{0r}	N	Grease lubrication	Oil lubrication	
17	30	18	0.3	22	0.5	15 200	21 700	2 650	12 000	18 000	NA5903
	30	23	0.3	22	1	18 200	27 200	3 300	12 000	18 000	NA6903R
20	32	16	0.3	24	0.5	15 200	22 300	2 720	11 000	17 000	NK24/16R+IR20×24×16
	32	20	0.3	24	0.5	18 600	28 800	3 500	11 000	17 000	NK24/20R+IR20×24×20
	37	17	0.3	25	0.8	21 300	25 500	3 100	11 000	16 000	NA4904RCT
	37	23	0.3	25	0.8	28 400	37 000	4 500	11 000	16 000	NA5904
	37	30	0.3	25	1	36 500	50 500	6 150	11 000	16 000	NA6904R
22	34	16	0.3	26	0.5	15 600	23 600	2 880	10 000	15 000	8E-NK26/16RCT+IR22×26×16
	34	20	0.3	26	0.5	19 100	30 500	3 700	10 000	15 000	NK26/20R+IR22×26×20
	39	17	0.3	28	0.8	23 200	29 300	3 600	9 500	14 000	NA49/22R
	39	23	0.3	28	0.8	26 400	37 500	4 600	9 500	14 000	NA59/22
	39	30	0.3	28	0.5	40 000	58 500	7 150	9 500	14 000	NA69/22R
25	38	20	0.3	29	1	22 200	34 000	4 150	9 500	14 000	NK29/20R+IR25×29×20
	38	30	0.3	29	1.5	27 500	50 500	6 150	9 500	14 000	NK29/30R+IR25×29×30
	42	17	0.3	30	0.8	24 000	31 500	3 800	8 500	13 000	NA4905R
	42	23	0.3	30	0.8	30 500	43 000	5 200	8 500	13 000	NA5905
	42	30	0.3	30	1	41 500	63 000	7 650	8 500	13 000	NA6905R
28	42	20	0.3	32	1	23 500	37 500	4 600	8 500	13 000	NK32/20R+IR28×32×20
	42	30	0.3	32	1.5	34 000	60 500	7 350	8 500	13 000	NK32/30R+IR28×32×30
	45	17	0.3	32	0.8	24 800	33 500	4 050	8 500	13 000	NA49/28RCT
	45	23	0.3	32	0.8	32 000	45 500	5 550	8 500	13 000	NA59/28
	45	30	0.3	32	1	43 000	67 000	8 150	8 500	13 000	NA69/28R
30	45	20	0.3	35	0.5	24 800	41 500	5 050	7 500	11 000	NK35/20RCT+IR30×35×20
	45	30	0.3	35	1	36 000	66 500	8 100	7 500	11 000	NK35/30R+IR30×35×30
	47	17	0.3	35	0.8	25 500	35 500	4 300	7 500	11 000	NA4906R
	47	23	0.3	35	0.8	32 500	48 500	5 950	7 500	11 000	NA5906
	47	30	0.3	35	1	42 500	67 500	8 250	7 500	11 000	NA6906R
32	47	20	0.3	37	0.5	25 300	43 500	5 300	7 500	11 000	NK37/20R+IR32×37×20
	47	30	0.3	37	1	36 500	69 500	8 500	7 500	11 000	NK37/30R+IR32×37×30
	52	20	0.6	40	0.8	31 500	47 500	5 800	6 500	10 000	NA49/32R

1) Smallest allowable dimension for chamfer dimension r.

2) Allowable axial movement amount of the inner ring with respect to the outer ring.

3) Largest allowable dimension for fillet radius r_a of housing and shaft.

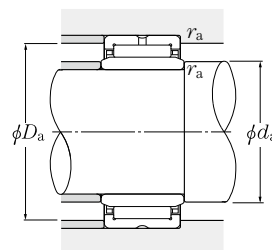

Installation-related dimensions			Mass
mm			
d _a	D _a	r _{as} ³⁾	kg
Min.	Max.	Max.	(approx.)
19	28	0.3	0.056
19	28	0.3	0.069
22	30	0.3	0.049
22	30	0.3	0.061
22	35	0.3	0.074
22	35	0.3	0.115
22	35	0.3	0.141
24	32	0.3	0.046
24	32	0.3	0.064
24	37	0.3	0.080
24	37	0.3	0.134
24	37	0.3	0.154
27	36	0.3	0.079
27	36	0.3	0.123
27	40	0.3	0.088
27	40	0.3	0.139
27	40	0.3	0.162
30	40	0.3	0.096
30	40	0.3	0.146
30	43	0.3	0.098
30	43	0.3	0.142
30	43	0.3	0.179
32	43	0.3	0.112
32	43	0.3	0.171
32	45	0.3	0.101
32	45	0.3	0.152
32	45	0.3	0.185
34	45	0.3	0.117
34	45	0.3	0.170
36	48	0.6	0.157

Note: The number of inner rings (IR) is composed of the IR inner diameter dimension × outer diameter dimension × width dimension.

Machined-ring needle roller bearings with an inner ring

NA49 type
NA59 type
NA69 type
NK+IR type

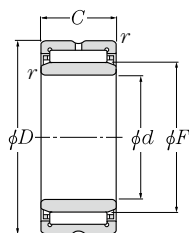

NA49···R type
NA59 type
NA69···R type ($\phi d \leq 30\text{mm}$)
NK···R+IR type

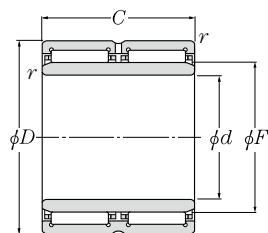

NA69···R type
($\phi d \geq 32\text{mm}$)

d 32 ~ 55mm

Boundary dimensions						Basic load rating		Fatigue load limit	Allowable speed		Number
mm						dynamic	static		min ⁻¹		
d	D	C	r _{s min} ¹⁾	F	s ²⁾	C _T	N	N	Grease lubrication	Oil lubrication	
32	52	27	0.6	40	0.8	38 000	61 000	7 450	6 500	10 000	NA59/32
	52	36	0.6	40	0.5	47 500	82 000	10 000	6 500	10 000	NA69/32R
35	50	20	0.3	40	0.5	26 400	47 000	5 750	6 500	10 000	NK40/20R+IR35×40×20
	50	30	0.3	40	1	38 500	76 000	9 250	6 500	10 000	NK40/30R+IR35×40×30
	55	20	0.6	42	0.8	32 000	50 000	6 100	6 500	9 500	NA4907R
	55	27	0.6	42	0.8	39 000	64 500	7 850	6 500	9 500	NA5907
38	55	36	0.6	42	0.5	49 000	86 500	10 500	6 500	9 500	NA6907R
	53	20	0.3	43	0.5	27 500	51 000	6 200	6 500	9 500	NK43/20R+IR38×43×20
40	53	30	0.3	43	1	40 000	82 000	10 000	6 500	9 500	NK43/30R+IR38×43×30
	55	20	0.3	45	0.5	28 000	52 500	6 450	6 000	9 000	NK45/20R+IR40×45×20
	55	30	0.3	45	1	41 000	85 500	10 400	6 000	9 000	NK45/30RCT+IR40×45×30
	62	22	0.6	48	1	43 500	66 500	8 150	5 500	8 500	NA4908R
42	62	30	0.6	48	1	53 000	92 500	11 300	5 500	8 500	NA5908
	62	40	0.6	48	0.5	67 000	116 000	14 100	5 500	8 500	NA6908R
45	57	20	0.3	47	0.5	28 800	55 500	6 800	5 500	8 500	NK47/20RCT+IR42×47×20
	57	30	0.3	47	1	42 500	91 500	11 200	5 500	8 500	NK47/30R+IR42×47×30
50	62	25	0.6	50	1.5	38 500	74 500	9 050	5 500	8 000	NK50/25RCT+IR45×50×25
	62	35	0.6	50	2	51 000	106 000	12 900	5 500	8 000	NK50/35R+IR45×50×35
	68	22	0.6	52	1	46 000	73 000	8 950	5 000	7 500	NA4909R
	68	30	0.6	52	1	56 000	101 000	12 300	5 000	7 500	NA5909
55	68	40	0.6	52	0.5	70 500	127 000	15 500	5 000	7 500	NA6909R
	68	25	0.6	55	1.5	41 000	82 000	10 000	5 000	7 500	NK55/25R+IR50×55×25
	68	35	0.6	55	2	54 000	118 000	14 300	5 000	7 500	NK55/35R+IR50×55×35
	72	22	0.6	58	1	48 000	80 000	9 750	4 700	7 000	NA4910R
55	72	30	0.6	58	1	58 000	110 000	13 400	4 700	7 000	NA5910
	72	40	0.6	58	0.5	74 000	139 000	17 000	4 700	7 000	NA6910R
	72	25	0.6	60	1.5	41 000	85 000	10 400	4 300	6 500	NK60/25R+IR55×60×25
55	72	35	0.6	60	2	57 000	130 000	15 800	4 300	6 500	NK60/35R+IR55×60×35
	80	25	1	63	1.5	58 500	99 500	12 100	4 300	6 500	NA4911R

1) Smallest allowable dimension for chamfer dimension r.
2) Allowable axial movement amount of the inner ring with respect to the outer ring.
3) Largest allowable dimension for fillet radius r_a of housing and shaft.

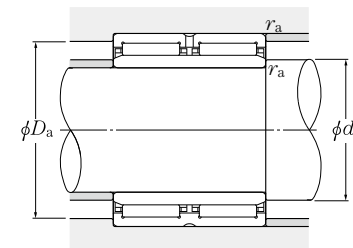
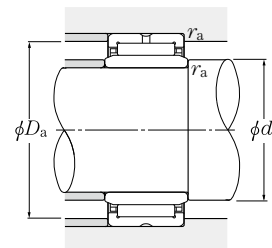

Installation-related dimensions			Mass
mm			
d _a	D _a	r _{as} ³⁾	kg
Min.	Max.	Max.	(approx.)
36	48	0.6	0.241
36	48	0.6	0.286
37	48	0.3	0.130
37	48	0.3	0.193
39	51	0.6	0.171
39	51	0.6	0.256
39	51	0.6	0.310
40	51	0.3	0.134
40	51	0.3	0.207
42	53	0.3	0.143
42	53	0.3	0.216
44	58	0.6	0.232
44	58	0.6	0.348
44	58	0.6	0.426
44	55	0.3	0.148
44	55	0.3	0.222
48	58	0.6	0.229
48	58	0.6	0.322
49	64	0.6	0.270
49	64	0.6	0.396
49	64	0.6	0.437
53	64	0.6	0.271
53	64	0.6	0.379
54	68	0.6	0.276
54	68	0.6	0.498
54	68	0.6	0.529
58	68	0.6	0.271
58	68	0.6	0.379
60	75	1	0.396

Note: The number of inner rings (IR) is composed of the IR inner diameter dimension × outer diameter dimension × width dimension.

Machined-ring needle roller bearings with an inner ring

NA49 type
NA59 type
NA69 type
NK+IR type

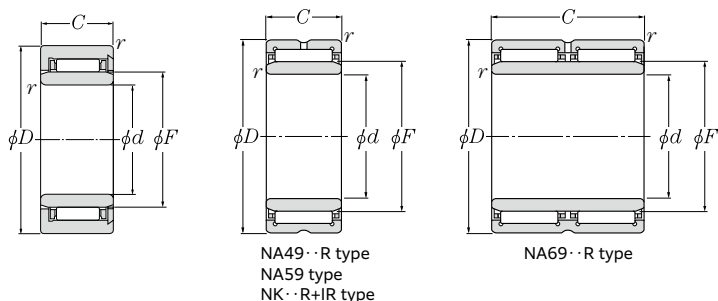

d 55 ~ 85mm

Boundary dimensions						Basic load rating		Fatigue load limit	Allowable speed		Number
mm						dynamic	static		min ⁻¹		
d	D	C	r _{s min} ¹⁾	F	s ²⁾	C _r	C _{0r}	N	Grease lubrication	Oil lubrication	
55	80	34	1	63	1.5	76 500	140 000	17 100	4 300	6 500	NA5911
	80	45	1	63	1.5	94 000	183 000	22 300	4 300	6 500	NA6911R
60	82	25	1	68	1	44 500	89 000	10 800	4 000	6 000	NK68/25R+IR60×68×25
	82	35	0.6	68	1	63 000	139 000	17 000	4 000	6 000	NK68/35R+IR60×68×35
	85	25	1	68	1.5	61 500	108 000	13 100	4 000	6 000	NA4912R
	85	34	1	68	1.5	80 500	153 000	18 600	4 000	6 000	NA5912
	85	45	1	68	1.5	95 500	191 000	23 200	4 000	6 000	NA6912R
65	90	25	0.6	73	1	54 000	100 000	12 200	3 700	5 500	NK73/25R+IR65×73×25
	90	25	1	72	1.5	62 500	112 000	13 700	3 700	5 500	NA4913R
	90	34	1	72	1.5	84 000	165 000	20 100	3 700	5 500	NA5913
	90	35	0.6	73	1	76 500	156 000	19 100	3 700	5 500	NK73/35R+IR65×73×35
	90	45	1	72	1.5	97 000	198 000	24 200	3 700	5 500	NA6913R
70	95	25	1	80	0.8	57 000	119 000	14 500	3 300	5 000	NK80/25R+IR70×80×25
	95	35	1	80	0.8	79 500	184 000	22 400	3 300	5 000	NK80/35R+IR70×80×35
	100	30	1	80	1.5	85 500	156 000	19 000	3 300	5 000	NA4914R
	100	40	1	80	1.5	103 000	187 000	22 800	3 300	5 000	NA5914
	100	54	1	80	1	130 000	267 000	32 500	3 300	5 000	NA6914R
75	105	25	1	85	1	70 500	123 000	15 000	3 100	4 700	NK85/25R+IR75×85×25
	105	30	1	85	1.5	87 000	162 000	19 700	3 100	4 700	NA4915R
	105	35	1	85	1	100 000	193 000	23 600	3 100	4 700	NK85/35R+IR75×85×35
	105	40	1	85	1.5	109 000	205 000	25 000	3 100	4 700	NA5915
	105	54	1	85	1	132 000	277 000	34 000	3 100	4 700	NA6915R
80	110	25	1	90	1	71 500	128 000	15 600	2 900	4 400	NK90/25R+IR80×90×25
	110	30	1	90	1.5	90 500	174 000	21 200	2 900	4 400	NA4916R
	110	35	1	90	1	104 000	208 000	25 400	2 900	4 400	NK90/35R+IR80×90×35
	110	40	1	90	1.5	115 000	223 000	27 200	2 900	4 400	NA5916
	110	54	1	90	1.5	138 000	298 000	36 500	2 900	4 400	NA6916R
85	115	26	1	95	1.5	74 500	137 000	16 600	2 800	4 200	NK95/26R+IR85×95×26
	115	36	1	95	1.5	108 000	223 000	27 000	2 800	4 200	NK95/36R+IR85×95×36

1) Smallest allowable dimension for chamfer dimension r.
2) Allowable axial movement amount of the inner ring with respect to the outer ring.
3) Largest allowable dimension for fillet radius r_a of housing and shaft.

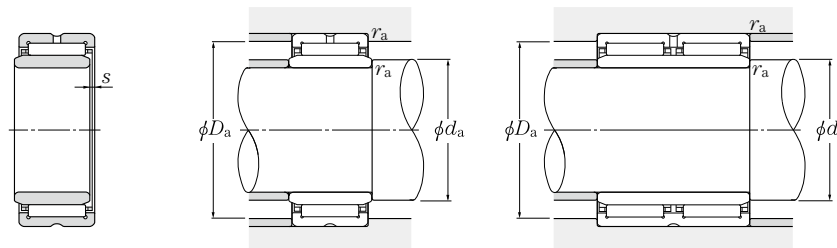

Installation-related dimensions			Mass
mm			
d _a Min.	D _a Max.	r _{as} ³⁾ Max.	kg (approx.)
60	75	1	0.559
60	75	1	0.726
65	77	0.6	0.393
64	78	0.6	0.551
65	80	1	0.427
65	80	1	0.614
65	80	1	0.758
69	86	0.6	0.466
70	85	1	0.454
70	85	1	0.655
69	86	0.6	0.660
70	85	1	0.779
75	90	1	0.525
75	90	1	0.738
75	95	1	0.727
75	95	1	1.06
75	95	1	1.34
80	100	1	0.642
80	100	1	0.776
80	100	1	0.853
80	100	1	1.13
80	100	1	1.45
85	105	1	0.680
85	105	1	0.820
85	105	1	0.959
85	105	1	1.15
85	105	1	1.53
90	110	1	0.644
90	110	1	1.05

Note: The number of inner rings (IR) is composed of the IR inner diameter dimension × outer diameter dimension × width dimension.

Needle Roller Bearings



Machined-ring needle roller bearings with an inner ring

- NA48 type
- NA49 type
- NA59 type
- NA69 type
- NK+IR type

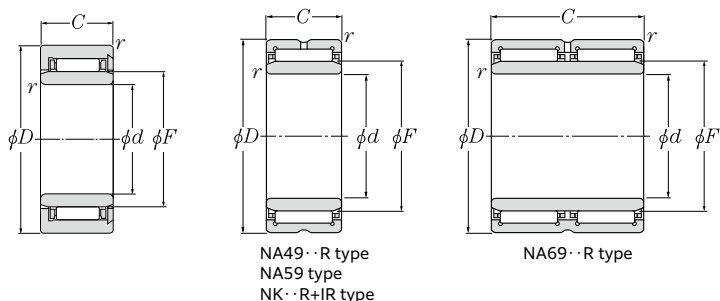

d 85 ~ 130mm

Boundary dimensions						Basic load rating		Fatigue load limit	Allowable speed		Number
mm						dynamic	static		min ⁻¹		
d	D	C	r _{s min} ¹⁾	F	s ²⁾	C _T	N	C _U	Grease lubrication	Oil lubrication	
85	120	35	1.1	100	1	112 000	237 000	28 400	2 700	4 000	NA4917R
	120	46	1.1	100	1.5	137 000	290 000	34 500	2 700	4 000	NA5917
	120	63	1.1	100	1	169 000	400 000	48 000	2 700	4 000	NA6917R
90	120	26	1	100	1.5	73 500	137 000	16 400	2 700	4 000	NK100/26R + IR90 × 100 × 26
	120	36	1	100	1.5	107 000	223 000	26 700	2 700	4 000	NK100/36R + IR90 × 100 × 36
	125	35	1.1	105	1	116 000	252 000	29 800	2 500	3 800	NA4918R
	125	46	1.1	105	1	143 000	310 000	37 000	2 500	3 800	NA5918
	125	63	1.1	105	1	175 000	425 000	50 500	2 500	3 800	NA6918R
95	125	26	1	105	1.5	76 500	147 000	17 300	2 500	3 800	NK105/26R + IR95 × 105 × 26
	125	36	1	105	1.5	111 000	238 000	28 100	2 500	3 800	NK105/36R + IR95 × 105 × 36
	130	35	1.1	110	1	118 000	260 000	30 500	2 400	3 600	NA4919R
	130	46	1.1	110	1	149 000	335 000	39 000	2 400	3 600	NA5919
	130	63	1.1	110	1	177 000	440 000	51 000	2 400	3 600	NA6919R
100	130	30	1.1	110	1.5	97 500	204 000	23 800	2 400	3 600	NK110/30R + IR100 × 110 × 30
	130	40	1.1	110	2	129 000	292 000	34 000	2 400	3 600	NK110/40R + IR100 × 110 × 40
	140	40	1.1	115	2	127 000	260 000	29 900	2 300	3 500	NA4920
	140	54	1.1	115	2	182 000	395 000	45 500	2 300	3 500	NA5920
110	140	30	1	120	0.8	95 000	214 000	24 400	2 200	3 300	NA4822
	140	40	1.1	120	—	114 000	271 000	31 000	2 200	3 300	NK120/40 + IR110 × 120 × 40
	150	40	1.1	125	2	131 000	279 000	31 500	2 100	3 200	NA4922
	150	54	1.1	125	2	193 000	440 000	49 500	2 100	3 200	NA5922
120	150	30	1	130	0.8	101 000	237 000	26 400	2 100	3 100	NA4824
	150	40	1.1	130	—	117 000	287 000	32 000	2 100	3 100	NK130/40 + IR120 × 130 × 40
	165	45	1.1	135	2	180 000	380 000	41 500	2 000	3 000	NA4924
	165	60	1.1	135	2	246 000	530 000	57 500	2 000	3 000	NA5924
130	165	35	1.1	145	1	120 000	310 000	33 000	1 900	2 800	NA4826
	170	32	1.5	145	—	111 000	238 000	25 600	1 900	2 800	NK145/32 + IR130 × 145 × 32
	170	42	1.5	145	—	153 000	360 000	38 500	1 900	2 800	NK145/42 + IR130 × 145 × 42
	180	50	1.5	150	1.5	202 000	455 000	48 000	1 800	2 700	NA4926
	180	67	1.5	150	1.5	296 000	690 000	73 000	1 800	2 700	NA5926

1) Smallest allowable dimension for chamfer dimension r.
2) Allowable axial movement amount of the inner ring with respect to the outer ring.
3) Largest allowable dimension for fillet radius r_a of housing and shaft.

Needle Roller Bearings

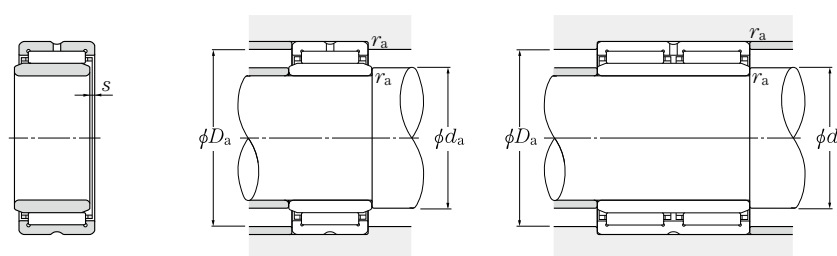

Installation-related dimensions			Mass
mm			
d _a	D _a	r _{as} ³⁾	kg
Min.	Max.	Max.	(approx.)
91.5	113.5	1	1.24
91.5	113.5	1	1.76
91.5	104	1.1	2.25
95	115	1	0.781
95	115	1	1.09
96.5	118.5	1	1.84
96.5	118.5	1	2.44
96.5	109	1.1	2.37
100	120	1	0.819
100	120	1	1.15
101.5	123.5	1	1.36
101.5	123.5	1	1.98
101.5	123.5	1	2.63
106.5	123.5	1	0.990
106.5	123.5	1	1.34
106.5	133.5	1	1.93
106.5	133.5	1	2.85
115	135	1	1.11
116.5	133.5	1	1.49
116.5	143.5	1	2.08
116.5	143.5	1	2.98
125	145	1	1.17
126.5	143.5	1	1.57
126.5	158.5	1	2.84
126.5	158.5	1	3.92
136.5	158.5	1	1.60
138	162.5	1.5	1.90
138	162.5	1.5	2.54
138	172	1.5	3.90
138	172	1.5	5.60

Note: The number of inner rings (IR) is composed of the IR inner diameter dimension × outer diameter dimension × width dimension.

Needle Roller Bearings



Machined-ring needle roller bearings with an inner ring

NA48 type
NA49 type
NA59 type
NA69 type
NK+IR type

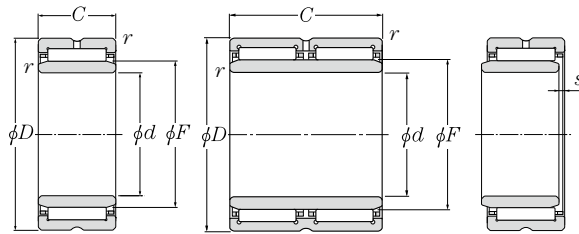

NA48 type
NA49...R type, NA49 type
NA59 type
NK...R+IR type, NK+IR type
NKS+IR type ($\phi d \geq 100\text{mm}$)

d 140 ~ 280mm

Boundary dimensions						Basic load rating		Fatigue load limit	Allowable speed		Number
mm						dynamic	static		min ⁻¹		
d	D	C	r _{s min} ¹⁾	F	s ²⁾	C _r	N	C _u	Grease lubrication	Oil lubrication	
140	175	35	1.1	155	1	121 000	315 000	33 500	1 700	2 600	NA4828
	180	32	1.5	155	—	114 000	252 000	26 500	1 700	2 600	NK155/32+IR140×155×32
	180	42	1.5	155	—	156 000	380 000	40 000	1 700	2 600	NK155/42+IR140×155×42
	190	50	1.5	160	1.5	209 000	485 000	50 500	1 700	2 500	NA4928
	190	67	1.5	160	1.5	315 000	760 000	79 000	1 700	2 500	NA5928
150	190	32	1.5	165	—	117 000	265 000	27 500	1 600	2 400	NK165/32+IR150×165×32
	190	40	1.1	165	1.5	152 000	390 000	40 500	1 600	2 400	NA4830
	190	42	1.5	165	—	160 000	400 000	41 000	1 600	2 400	NK165/42+IR150×165×42
	210	60	2	170	1.5	261 000	610 000	62 500	1 600	2 400	NA4930
160	200	40	1.1	175	1.5	160 000	425 000	43 500	1 500	2 300	NA4832
	220	60	2	180	1.5	270 000	650 000	65 500	1 500	2 200	NA4932
170	215	45	1.1	185	1.5	185 000	495 000	49 500	1 500	2 200	NA4834
	230	60	2	190	1.5	279 000	690 000	68 500	1 400	2 100	NA4934
180	225	45	1.1	195	1.5	195 000	540 000	53 500	1 400	2 100	NA4836
	250	69	2	205	1.5	375 000	890 000	86 000	1 300	2 000	NA4936
190	240	50	1.5	210	1.5	227 000	680 000	65 500	1 300	1 900	NA4838
	260	69	2	215	1.5	390 000	945 000	90 500	1 300	1 900	NA4938
200	250	50	1.5	220	1.5	231 000	705 000	67 000	1 200	1 800	NA4840
	280	80	2.1	225	1.5	505 000	1 180 000	111 000	1 200	1 800	NA4940
220	270	50	1.5	240	1.5	244 000	780 000	72 500	1 100	1 700	NA4844
	300	80	2.1	245	1.5	525 000	1 270 000	116 000	1 100	1 600	NA4944
240	300	60	2	265	2	365 000	1 090 000	98 500	1 000	1 500	NA4848
	320	80	2.1	265	2	540 000	1 350 000	121 000	1 000	1 500	NA4948
260	320	60	2	285	2	375 000	1 170 000	103 000	950	1 400	NA4852
	360	100	2.1	290	2	810 000	1 920 000	166 000	950	1 400	NA4952
280	350	69	2	305	2.5	455 000	1 300 000	112 000	850	1 300	NA4856
	380	100	2.1	310	2.5	840 000	2 050 000	175 000	850	1 300	NA4956

1) Smallest allowable dimension for chamfer dimension r.
2) Allowable axial movement amount of the inner ring with respect to the outer ring.
3) Largest allowable dimension for fillet radius r_a of housing and shaft.

Needle Roller Bearings

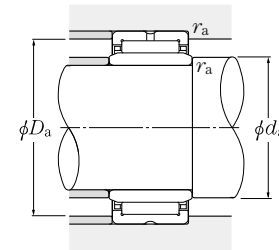

Installation-related dimensions			Mass
mm			
d _a	D _a	r _{as} ³⁾	kg
Min.	Max.	Max.	(approx.)
146.5	168.5	1	1.82
148	172	1.5	2.04
148	172	1.5	2.69
148	182	1.5	4.05
148	182	1.5	6.18
158	182	1.5	2.32
156.5	183.5	1	2.72
158	182	1.5	2.84
159	201	2	5.33
166.5	193.5	1	2.90
169	211	2	5.60
176.5	208.5	1	3.99
179	221	2	5.87
186.5	218.5	1	4.19
189	241	2	8.58
198	232	1.5	5.62
199	251	2	8.68
208	242	1.5	5.84
211	269	2	12.2
228	262	1.5	6.37
231	289	2	13.5
249	291	2	10.0
251	309	2	14.7
269	311	2	10.8
271	349	2	25.9
289	341	2	15.5
291	369	2	27.5

Note: The number of inner rings (IR) is composed of the IR inner diameter dimension × outer diameter dimension × width dimension.

Machined-ring needle roller bearings with an inner ring

NA48 type
NA49 type
NA59 type
NK+IR type

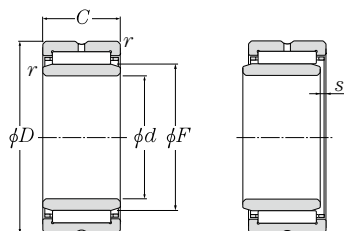

d 300 ~ 440mm

Boundary dimensions	mm					Basic load rating		Fatigue load limit	Allowable speed		Number
	d	D	C	$r_{s \min}^{1)}$	F	$s^{2)}$	dynamic C_T		static C_{0r}	N	
300	380	80	2.1	330	2	625 000	1 770 000	149 000	800	1 200	NA4860
	420	118	3	340	2	1 080 000	2 640 000	219 000	800	1 200	NA4960
320	400	80	2.1	350	2	640 000	1 850 000	153 000	750	1 100	NA4864
	440	118	3	360	2	1 120 000	2 820 000	230 000	750	1 100	NA4964
340	420	80	2.1	370	2	655 000	1 940 000	158 000	750	1 100	NA4868
	460	118	3	380	2	1 160 000	3 000 000	242 000	750	1 100	NA4968
360	440	80	2.1	390	2	665 000	2 020 000	162 000	650	1 000	NA4872
	480	118	3	400	2	1 200 000	3 200 000	253 000	650	1 000	NA4972
380	480	100	2.1	415	2	1 000 000	2 840 000	223 000	650	950	NA4876
	520	140	4	430	2	1 400 000	3 750 000	292 000	650	950	NA4976
400	540	140	4	450	2.5	1 450 000	4 000 000	305 000	600	900	NA4980
420	560	140	4	470	2.5	1 500 000	4 250 000	320 000	550	850	NA4984
440	600	160	4	490	2.5	1 750 000	4 600 000	340 000	550	800	NA4988

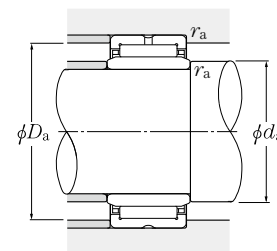

Installation-related dimensions	mm			Mass
	d_a	D_a	$r_{as}^{3)}$	
	Min.	Max.	Max.	(approx.)
311	369	2	22.0	
313	407	2.5	42.5	
331	389	2	23.2	
333	427	2.5	45.2	
351	409	2	24.1	
353	447	2.5	47.3	
371	429	2	25.7	
373	467	2.5	49.0	
391	469	2	44.5	
396	504	3	73.6	
416	524	3	76.6	
436	544	3	89.8	
456	584	3	123	

1) Smallest allowable dimension for chamfer dimension r .
2) Allowable axial movement amount of the inner ring with respect to the outer ring.
3) Largest allowable dimension for fillet radius r_a of housing and shaft.

Note: The number of inner rings (IR) is composed of the IR inner diameter dimension × outer diameter dimension × width dimension.

Needle Roller Bearings



Thrust cylindrical roller bearings

811 type
812 type
893 type

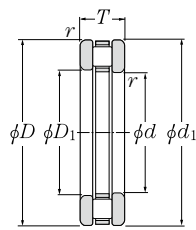

811 type
812 type
(Bearing)

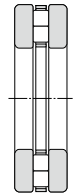

893 type
(Bearing)

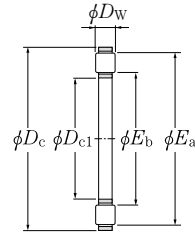

K811 type, K812 type
(Thrust cylindrical roller
and cage assembly)

d 10 ~ 60mm

d	Boundary dimensions									Basic load rating		Fatigue load limit N C _u	Allowable speed	
	D	d ₁	D ₁	T	mm D _{c1} ²⁾ E11	D _c a13	D _w -0.010	B	r _{s min} ¹⁾	dynamic C _a	static C _{0a}		min ⁻¹ Grease lubrication	Oil lubrication
10	24	24	10	9	10	24	3.5	2.75	0.3	10 300	20 100	2 450	3 400	13 000
12	26	26	12	9	12	26	3.5	2.75	0.3	10 900	22 300	2 720	3 000	12 000
15	28	28	16	9	15	28	3.5	2.75	0.3	12 200	26 800	3 250	2 800	11 000
17	30	30	18	9	17	30	3.5	2.75	0.3	12 700	29 000	3 550	2 500	10 000
20	35	35	21	10	20	35	4.5	2.75	0.3	20 200	46 500	5 650	2 100	8 500
25	42	42	26	11	25	42	5	3	0.6	27 300	68 000	8 250	1 800	7 000
30	47	47	32	11	30	47	5	3	0.6	27 800	72 500	8 850	1 500	6 000
	52	52	32	16	30	52	7.5	4.25	0.6	53 000	129 000	15 700	1 500	6 000
	60	60	32	18	30	60	5.5	6.25	1	54 000	166 000	20 200	1 300	5 000
35	52	52	37	12	35	52	5	3.5	0.6	31 000	87 000	10 600	1 400	5 500
	62	62	37	18	35	62	7.5	5.25	1	54 500	139 000	17 000	1 200	4 900
	68	68	37	20	35	68	6	7	1	66 500	214 000	26 100	1 200	4 600
40	60	60	42	13	40	60	6	3.5	0.6	43 000	121 000	14 800	1 200	4 800
	68	68	42	19	40	68	9	5	1	74 500	190 000	23 200	1 100	4 400
	78	78	42	22	40	78	7	7.5	1	85 000	277 000	34 000	1 000	4 000
45	65	65	47	14	45	65	6	4	0.6	45 500	135 000	16 500	1 100	4 400
	73	73	47	20	45	73	9	5.5	1	82 000	222 000	27 000	1 000	4 100
	85	85	47	24	45	85	7.5	8.25	1	102 000	345 000	42 000	900	3 600
50	70	70	52	14	50	70	6	4	0.6	48 500	150 000	18 300	1 000	4 000
	78	78	52	22	50	78	9	6.5	1	85 000	238 000	29 000	950	3 800
	95	95	52	27	50	95	8	9.5	1.1	125 000	445 000	54 000	800	3 200
55	78	78	57	16	55	78	6	5	0.6	62 500	215 000	26 200	900	3 600
	90	90	57	25	55	90	11	7	1	121 000	340 000	41 500	830	3 300
	105	105	57	30	55	105	9	10.5	1.1	158 000	570 000	69 500	730	2 900
60	85	85	62	17	60	85	7.5	4.75	1	69 000	215 000	26 200	830	3 300
	95	95	62	26	60	95	11	7.5	1	126 000	365 000	44 500	780	3 100
	110	110	62	30	60	110	9	10.5	1.1	162 000	600 000	73 500	680	2 700

1) Smallest allowable dimension for chamfer dimension r.
2) The tolerance of bearings with suffix code T2 is E12.

Needle Roller Bearings

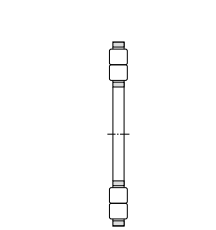

K893 type
(Thrust cylindrical roller
and cage assembly)

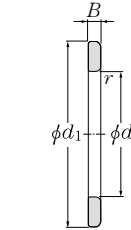

WS type raceway
(Inner ring)

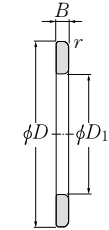

GS type raceway
(Outer ring)

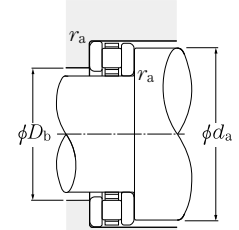

Bearing	Number			Approx. dimension mm		Installation-related dimensions mm			Mass kg (approx.)			
	Thrust cylindrical roller and cage assembly	Inner ring	Outer ring	E _b	E _a	d _a Min.	D _b Max.	r _{as} Max.	811	K811 K812 K893	WS811 WS812 WS893	GS811 GS812 GS893
81100T2	K81100T2	WS81100	GS81100	13.5	21.3	21	14	0.3	0.020	0.0035	0.0081	0.0081
81101T2	K81101T2	WS81101	GS81101	15.5	23.3	23	16	0.3	0.022	0.0040	0.0090	0.0090
81102T2	K81102T2	WS81102	GS81102	17.2	25	25	18	0.3	0.024	0.0060	0.0095	0.0090
81103T2	K81103T2	WS81103	GS81103	19.2	27	27	20	0.3	0.028	0.0080	0.010	0.010
81104T2	K81104T2	WS81104	GS81104	22.4	32.3	32	23	0.3	0.039	0.012	0.014	0.013
81105T2	K81105T2	WS81105	GS81105	27.6	38.7	39	28	0.6	0.059	0.018	0.021	0.020
81106T2	K81106T2	WS81106	GS81106	33.1	43.9	44	33	0.6	0.066	0.020	0.024	0.022
81206T2	K81206T2	WS81206	GS81206	32.8	49	48	33	0.6	0.141	0.050	0.047	0.044
89306	K89306	WS89306	GS89306	34	56.4	56	34	1	0.249	0.046	0.104	0.099
81107T2	K81107T2	WS81107	GS81107	38	48.9	49	38	0.6	0.085	0.024	0.032	0.029
81207T2	K81207T2	WS81207	GS81207	39.8	56	56	41	1	0.230	0.065	0.085	0.080
89307	K89307	WS89307	GS89307	40	64.4	64	40	1	0.351	0.064	0.147	0.140
81108T2	K81108T2	WS81108	GS81108	43.2	56.4	56	44	0.6	0.118	0.035	0.043	0.040
81208T2	K81208T2	WS81208	GS81208	43.7	62.9	63	44	1	0.266	0.085	0.093	0.088
89308	K89308	WS89308	GS89308	46	74.4	74	46	1	0.507	0.100	0.207	0.200
81109T2	K81109T2	WS81109	GS81109	48.4	61.6	61	49	0.6	0.144	0.040	0.054	0.050
81209T2	K81209T2	WS81209	GS81209	48.8	68	68	49	1	0.318	0.100	0.112	0.106
89309	K89309	WS89309	GS89309	50.9	81.3	81	51	1	0.660	0.140	0.264	0.255
81110T2	K81110T2	WS81110	GS81110	53.2	66.4	66	54	0.6	0.158	0.045	0.059	0.054
81210T2	K81210T2	WS81210	GS81210	53.7	73.1	73	54	1	0.384	0.105	0.144	0.135
89310	K89310	WS89310	GS89310	58	90.4	90	58	1	0.932	0.180	0.382	0.370
81111T2	K81111T2	WS81111	GS81111	57.8	75.2	75	58	0.6	0.242	0.060	0.094	0.087
81211T2	K81211T2	WS81211	GS81211	60.1	83.4	83	61	1	0.618	0.190	0.219	0.209
89311	K89311	WS89311	GS89311	63.9	100.3	100	64	1	1.26	0.240	0.518	0.503
81112T2	K81112T2	WS81112	GS81112	63.7	80.1	80	65	1	0.288	0.083	0.106	0.099
81212T2	K81212T2	WS81212	GS81212	64.9	88.4	88	66	1	0.690	0.200	0.251	0.240
89312	K89312	WS89312	GS89312	68.9	105.3	105	69	1	1.33	0.250	0.550	0.534

Needle Roller Bearings



Thrust cylindrical roller bearings

811 type
812 type

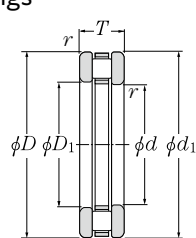

811 type
812 type
(Bearing)

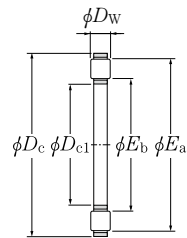

K811 type, K812 type
(Thrust cylindrical roller
and cage assembly)

d 140 ~ 160mm

d	Boundary dimensions									Basic load rating		Fatigue load limit N C _u	Allowable speed	
	D	d ₁	D ₁	T	mm D _{c1} E11	D _c a13	D _w -0.010	B h11	r _s (min ¹)	dynamic N C _a	static N C _{0a}		min ⁻¹ Grease lubrication	Oil lubrication
140	180	178	142	31	140	180	12	9.5	1	206 000	815 000	86 000	380	1 500
	200	197	143	46	140	200	19	13.5	1.5	370 000	1 280 000	133 000	350	1 400
150	190	188	152	31	150	190	12	9.5	1	214 000	870 000	90 500	350	1 400
160	200	198	162	31	160	200	12	9.5	1	221 000	930 000	95 000	330	1 300

Needle Roller Bearings

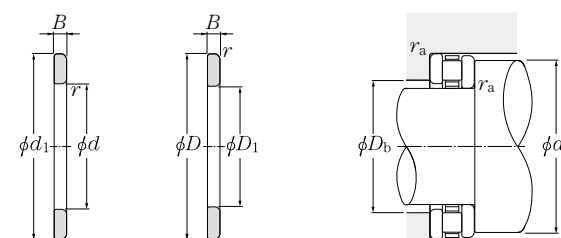

WS type raceway (Inner ring)
GS type raceway (Outer ring)

Bearing	Number			Approx. dimension mm		Installation-related dimensions mm			Mass kg (approx.)			
	Thrust cylindrical roller and cage assembly	Inner ring	Outer ring	E _b	E _a	d _a Min.	D _b Max.	r _{as} Max.	811	K811 K812 K893	WS811 WS812 WS893	GS811 GS812 GS893
81128	K81128	WS81128	GS81128	147.8	172.5	172	147	1	1.87	0.450	0.708	0.717
81228	K81228	WS81228	GS81228	150.1	189	188	150	1.5	4.43	1.20	1.60	1.63
81130	K81130	WS81130	GS81130	157.7	182.4	182	157	1	1.98	0.470	0.752	0.761
81132	K81132	WS81132	GS81132	167.8	192.5	192	167	1	2.10	0.500	0.797	0.806

1) Smallest allowable dimension for chamfer dimension r.

Thrust needle roller bearings

AXK11 type
AS11 type
WS811 type
GS811 type

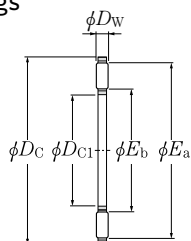

AXK type
(Thrust needle roller
and cage assembly)

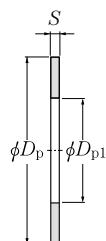

AS type raceway
(Washer)

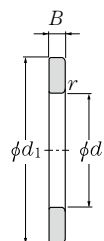

WS type raceway
(Inner ring)

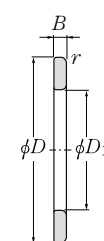

GS type raceway
(Outer ring)

D_{c1} 10 ~ 140mm

Boundary dimensions												Basic load rating		Fatigue load limit	
D_{c1}	D_c	D_w	D_p	D_{p1}	$S^{2)}$	mm		D	D_1	B	$r_s \text{ min}^{-1}$)	dynamic	static	N	
E11	c12	$0_{-0.010}$	e13	E12	± 0.05	d	d_1					C_a	C_{0a}	C_u	
10	24	2	24	10	1	10	24	24	10	2.75	$0_{-0.060}$	0.3	9 150	25 300	3 100
12	26	2	26	12	1	12	26	26	12	2.75	$0_{-0.060}$	0.3	9 850	28 900	3 500
15	28	2	28	15	1	15	28	28	16	2.75	$0_{-0.060}$	0.3	11 300	36 000	4 400
17	30	2	30	17	1	17	30	30	18	2.75	$0_{-0.060}$	0.3	11 900	39 500	4 800
20	35	2	35	20	1	20	35	35	21	2.75	$0_{-0.060}$	0.3	13 200	46 500	5 650
25	42	2	42	25	1	25	42	42	26	3	$0_{-0.060}$	0.6	14 600	58 000	7 050
30	47	2	47	30	1	30	47	47	32	3	$0_{-0.060}$	0.6	16 300	69 500	8 500
35	52	2	52	35	1	35	52	52	37	3.5	$0_{-0.075}$	0.6	17 800	81 500	9 900
40	60	3	60	40	1	40	60	60	42	3.5	$0_{-0.075}$	0.6	27 400	110 000	13 500
45	65	3	65	45	1	45	65	65	47	4	$0_{-0.075}$	0.6	29 800	128 000	15 600
50	70	3	70	50	1	50	70	70	52	4	$0_{-0.075}$	0.6	31 500	143 000	17 400
55	78	3	78	55	1	55	78	78	57	5	$0_{-0.075}$	0.6	38 000	186 000	22 700
60	85	3	85	60	1	60	85	85	62	4.75	$0_{-0.075}$	1	44 500	234 000	28 600
65	90	3	90	65	1	65	90	90	67	5.25	$0_{-0.075}$	1	46 500	254 000	31 000
70	95	4	95	70	1	70	95	95	72	5.25	$0_{-0.075}$	1	53 500	253 000	31 000
75	100	4	100	75	1	75	100	100	77	5.75	$0_{-0.075}$	1	55 000	266 000	32 500
80	105	4	105	80	1	80	105	105	82	5.75	$0_{-0.075}$	1	56 500	279 000	34 000
85	110	4	110	85	1	85	110	110	87	5.75	$0_{-0.075}$	1	57 500	291 000	35 500
90	120	4	120	90	1	90	120	120	92	6.5	$0_{-0.090}$	1	70 500	390 000	46 500
100	135	4	135	100	1	100	135	135	102	7	$0_{-0.090}$	1	90 000	550 000	64 000
110	145	4	145	110	1	110	145	145	112	7	$0_{-0.090}$	1	93 500	590 000	67 000
120	155	4	155	120	1	120	155	155	122	7	$0_{-0.090}$	1	99 000	650 000	72 000
130	170	5	170	130	1	130	170	170	132	9	$0_{-0.090}$	1	140 000	900 000	97 000
140	180	5	180	140	1	140	178	180	142	9.5	$0_{-0.090}$	1	145 000	960 000	102 000

1) Smallest allowable dimension for chamfer dimension r .
2) The measured thrust load is 2.04 N or above.

Allowable speed		Number				Approx. dimension		Mass			
min^{-1}		Thrust needle roller and cage assembly	Washer	Inner ring	Outer ring	E_b	E_a	kg(approx.)			
Grease lubrication	Oil lubrication							AXK11	AS11	WS811	GS811
3 500	14 000	AXK1100	AS1100	WS81100	GS81100	12.3	21.7	0.0028	0.0029	0.0081	0.0081
3 300	13 000	AXK1101	AS1101	WS81101	GS81101	14.3	23.7	0.0030	0.0033	0.0090	0.0090
2 800	11 000	AXK1102	AS1102	WS81102	GS81102	17.2	26.5	0.0035	0.0034	0.0095	0.0090
2 500	10 000	AXK1103	AS1103	WS81103	GS81103	19.2	28.5	0.0040	0.0038	0.010	0.010
2 100	8 500	AXK1104	AS1104	WS81104	GS81104	21.3	31.3	0.0050	0.0051	0.014	0.013
1 800	7 000	AXK1105	AS1105	WS81105	GS81105	29.5	39.4	0.0070	0.0070	0.021	0.020
1 500	6 000	AXK1106	AS1106	WS81106	GS81106	34.5	44.4	0.0080	0.0081	0.024	0.022
1 400	5 500	AXK1107	AS1107	WS81107	GS81107	39.5	49.4	0.010	0.0091	0.032	0.029
1 200	4 700	AXK1108	AS1108	WS81108	GS81108	44.2	56.2	0.019	0.012	0.043	0.040
1 100	4 300	AXK1109	AS1109	WS81109	GS81109	50.5	62.4	0.021	0.014	0.054	0.050
1 000	3 900	AXK1110	AS1110	WS81110	GS81110	55.5	67.4	0.024	0.015	0.059	0.054
900	3 500	AXK1111	AS1111	WS81111	GS81111	61.0	74.9	0.031	0.019	0.094	0.087
800	3 200	AXK1112	AS1112	WS81112	GS81112	66.0	81.9	0.039	0.022	0.106	0.099
750	3 000	AXK1113	AS1113	WS81113	GS81113	71.0	86.9	0.040	0.024	0.125	0.117
750	2 900	AXK1114	AS1114	WS81114	GS81114	75.5	91.4	0.060	0.025	0.134	0.124
700	2 700	AXK1115	AS1115	WS81115	GS81115	80.5	96.4	0.061	0.027	0.155	0.144
650	2 600	AXK1116	AS1116	WS81116	GS81116	84.4	100.3	0.063	0.029	0.164	0.152
600	2 400	AXK1117	AS1117	WS81117	GS81117	90.5	106.4	0.067	0.030	0.173	0.161
600	2 300	AXK1118	AS1118	WS81118	GS81118	96.5	116.4	0.086	0.039	0.252	0.238
500	2 000	AXK1120	AS1120	WS81120	GS81120	107.5	131.4	0.112	0.051	0.355	0.338
480	1 900	AXK1122	AS1122	WS81122	GS81122	115.5	139.4	0.122	0.055	0.385	0.366
430	1 700	AXK1124	AS1124	WS81124	GS81124	125.5	149.4	0.131	0.059	0.415	0.395
400	1 600	AXK1126	AS1126	WS81126	GS81126	136.0	164.0	0.205	0.074	0.666	0.637
380	1 500	AXK1128	AS1128	WS81128	GS81128	146.0	174.0	0.219	0.079	0.708	0.717

Needle Roller Bearings

NTN

Thrust needle roller bearings

AXK11 type
AS11 type
WS811 type
GS811 type

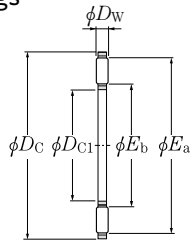

AXK type
(Thrust needle roller
and cage assembly)

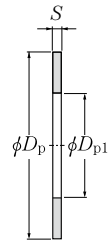

AS type raceway
(Washer)

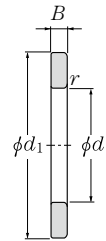

WS type raceway
(Inner ring)

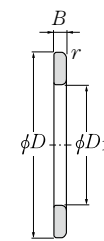

GS type raceway
(Outer ring)

D_{c1} 150 ~ 160mm

Boundary dimensions											Basic load rating		Fatigue load limit N C_u		
D_{c1} E11	D_c c12	D_w 0 -0.010	D_p e13	D_{p1} E12	$S^{2)}$ ± 0.05	d	d_1	D	D_1	B	$r_s \text{ min}^{1)}$	dynamic C_a		static N C_{0a}	
150	190	5	190	150	1	150	188	190	152	9.5	0 -0.090	1	149 000	1 020 000	106 000
160	200	5	200	160	1	160	198	200	162	9.5	0 -0.090	1	154 000	1 070 000	110 000

Needle Roller Bearings

NTN

Allowable speed		Thrust needle roller and cage assembly	Number			Approx. dimension mm		Mass kg(approx.)			
min ⁻¹	Oil lubrication		Washer	Inner ring	Outer ring	E_b	E_a	AXK11	AS11	WS811 WS812 WS893	GS811 GS812 GS893
350	1 400	AXK1130	AS1130	WS81130	GS81130	156.0	184.2	0.232	0.084	0.752	0.761
330	1 300	AXK1132	AS1132	WS81132	GS81132	166.0	194.2	0.246	0.089	0.797	0.806

1) Smallest allowable dimension for chamfer dimension r .
2) The measured thrust load is 2.04 N or above.

Needle Roller Bearings



Cam follower stud type track roller metric series

- KR··H type
- KR··XH type
- KR··LLH type
- KR··XLLH type

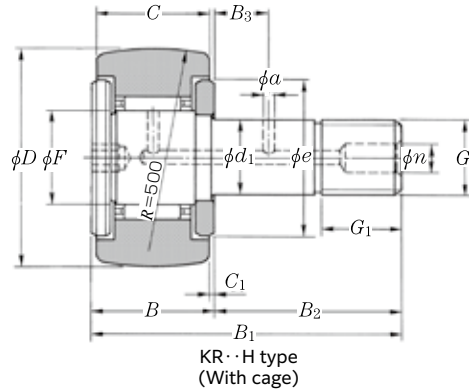
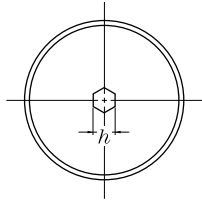

D 10 ~ 90mm

Outer dia. ¹⁾ mm D 0 -0.05	Dimensions mm													Basic load rating		Fatigue load limit N Cu	
	d ₁	C	F	B	B ₁	B ₂	G	G ₁	B ₃	C ₁	n	a	e	h	C _r		C _{0r}
10	3 ⁰ _{-0.010}	7	4	8	17	9	M3×0.5	5	—	0.5	—	—	7	2.5	1 640	1 270	155
12	4 ⁰ _{-0.012}	8	4.8	9	20	11	M4×0.7	6	—	0.5	—	—	8.5	2.5	2 170	1 690	206
13	5 ⁰ _{-0.012}	9	5.75	10	23	13	M5×0.8	7.5	—	0.5	—	—	9.5	3	2 650	2 260	276
16	6 ⁰ _{-0.012}	11	8	12	28	16	M6×1	8	—	0.6	—	—	12	3	4 050	4 200	510
19	8 ⁰ _{-0.015}	11	10	12	32	20	M8×1.25	10	—	0.6	—	—	14	4	4 750	5 400	660
22	10 ⁰ _{-0.015}	12	12	13	36	23	M10×1.25	12	—	0.6	4	—	17	4	5 300	6 650	810
26	10 ⁰ _{-0.015}	12	12	13	36	23	M10×1.25	12	—	0.6	4	—	17	4	5 300	6 650	810
30	12 ⁰ _{-0.018}	14	15	15	40	25	M12×1.5	13	6	0.6	6	3	23	6	7 850	9 650	1 180
32	12 ⁰ _{-0.018}	14	15	15	40	25	M12×1.5	13	6	0.6	6	3	23	6	7 850	9 650	1 180
35	16 ⁰ _{-0.018}	18	18	19.5	52	32.5	M16×1.5	17	8	0.8	6	3	27	6	12 200	17 900	2 180
40	18 ⁰ _{-0.018}	20	22	21.5	58	36.5	M18×1.5	19	8	0.8	6	3	32	6	14 000	22 800	2 790
47	20 ⁰ _{-0.021}	24	25	25.5	66	40.5	M20×1.5	21	9	0.8	8	4	37	8	20 700	33 500	4 100
52	20 ⁰ _{-0.021}	24	25	25.5	66	40.5	M20×1.5	21	9	0.8	8	4	37	8	20 700	33 500	4 100
62	24 ⁰ _{-0.021}	29	30	30.5	80	49.5	M24×1.5	25	11	0.8	8	4	44	8	28 900	55 000	6 700
72	24 ⁰ _{-0.021}	29	30	30.5	80	49.5	M24×1.5	25	11	0.8	8	4	44	8	28 900	55 000	6 700
80	30 ⁰ _{-0.021}	35	38	37	100	63	M30×1.5	32	15	1	8	4	53	8	45 000	88 500	10 800
85	30 ⁰ _{-0.021}	35	38	37	100	63	M30×1.5	32	15	1	8	4	53	8	45 000	88 500	10 800
90	30 ⁰ _{-0.021}	35	38	37	100	63	M30×1.5	32	15	1	8	4	53	8	45 000	88 500	10 800

1) The tolerance of outer ring outer diameter D of KR··XH type and KR··XLLH type having a cylindrical outer diameter surface is JIS 0 class.

Needle Roller Bearings

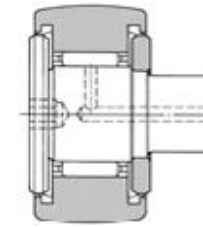

KR··LLH type
(Seal type with cage)

Accessories

Applied bearing number	Grease nipple number	Plug number	Applied hexagonal nut
10~19	—	—	1M3×0.5~1M8×1.25
22~26	NIP-B4	SEN4	1M10×1.25
30~40	NIP-B6	SEN3, SEN6	1M12×1.5~1M18×1.5
47~90	NIP-B8	SEN4, SEN8	1M20×1.5~1M30×1.5

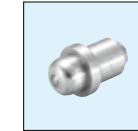

Grease fitting

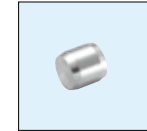

Plug

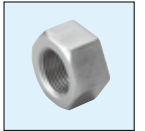

Hexagon nut

Track load capacity N		Allowable speed ²⁾ min ⁻¹		Maximum tightening torque N·m	Number ³⁾				Mass kg (approx.)	Stud dia. mm
Spherical outer ring	Cylindrical outer ring	Grease lubrication	Oil lubrication		Without seal		With seal			
Spherical outer ring	Cylindrical outer ring	Spherical outer ring	Cylindrical outer ring	Spherical outer ring	Cylindrical outer ring	Spherical outer ring	Cylindrical outer ring			
560	1 360	*27 000	*40 000	0.5	KR10T2H/3AS	KR10XT2H/3AS	KR10T2LLH/3AS	KR10XT2LLH/3AS	0.005	3
725	1 790	*25 000	*36 000	1	KR12T2H/3AS	KR12XT2H/3AS	KR12T2LLH/3AS	KR12XT2LLH/3AS	0.008	4
805	2 220	*23 000	*33 000	2	KR13T2H/3AS	KR13XT2H/3AS	KR13T2LLH/3AS	KR13XT2LLH/3AS	0.010	5
1 080	3 400	*19 000	*25 000	3	KR16FDOH/L588	KR16FXDOH/L588	KR16FLDOH/L588	KR16FXLDOH/L588	0.019	6
1 380	4 050	*15 000	*20 000	8	KR19FDOH/L588	KR19FXDOH/L588	KR19FLDOH/L588	KR19FXLDOH/L588	0.031	8
1 690	5 150	*12 000	*16 000	14	KR22FH	KR22FXH	KR22FLLH/3AS	KR22FXLLH/3AS	0.046	10
2 120	6 100	*12 000	*16 000	14	KR26FH	KR26FXH	KR26FLLH/3AS	KR26FXLLH/3AS	0.059	10
2 620	7 700	10 000	*13 000	20	KR30H	KR30XH	KR30LLH/3AS	KR30XLLH/3AS	0.087	12
2 860	8 200	10 000	*13 000	20	KR32H	KR32XH	KR32LLH/3AS	KR32XLLH/3AS	0.097	12
3 200	11 900	8 000	*11 000	52	KR35H	KR35XH	KR35LLH/3AS	KR35XLLH/3AS	0.169	16
3 850	14 500	7 000	9 000	76	KR40H	KR40XH	KR40LLH/3AS	KR40XLLH/3AS	0.248	18
4 700	21 000	6 000	8 000	98	KR47H	KR47XH	KR47LLH/3AS	KR47XLLH/3AS	0.386	20
5 550	23 300	6 000	8 000	98	KR52H	KR52XH	KR52LLH/3AS	KR52XLLH/3AS	0.461	20
6 950	34 500	5 000	6 500	178	KR62H	KR62XH	KR62LLH/3AS	KR62XLLH/3AS	0.790	24
8 050	38 500	5 000	6 500	178	KR72H	KR72XH	KR72LLH/3AS	KR72XLLH/3AS	1.04	24
9 800	53 000	4 000	5 500	360	KR80H	KR80XH	KR80LLH/3AS	KR80XLLH/3AS	1.55	30
10 400	56 000	4 000	5 500	360	KR85H	KR85XH	KR85LLH/3AS	KR85XLLH/3AS	1.74	30
11 400	59 000	4 000	5 500	360	KR90H	KR90XH	KR90LLH/3AS	KR90XLLH/3AS	1.95	30

2) The allowable speed of KR··LLH type and KR··XLLH type with a " *" seal is about 10 000 min⁻¹.
3) Bearings having T2 after the bearing number have a plastic cage, and the allowable temperature is 120°C and 100°C or below for continuous use.

Needle Roller Bearings



Cam follower stud type track roller metric series

- KR type
- KR··X type
- KR··LL type
- KR··XLL type

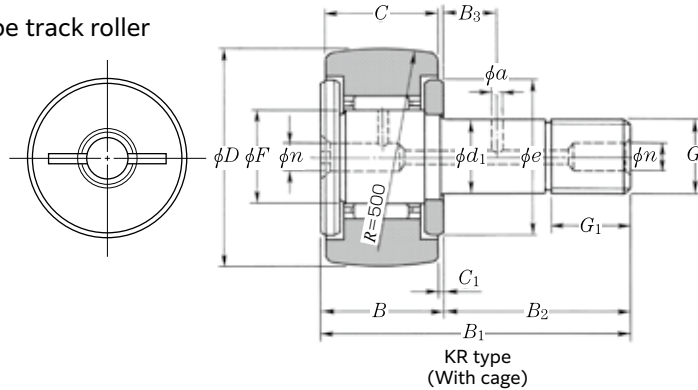

D 16 ~ 90mm

Outer dia. ¹⁾ mm D 0/-0.05	Dimensions mm											Basic load rating		Fatigue load limit N Cu		
	d1	C	F	B	B1	B2	G	G1	B3	C1	n	a	e		Cr	Cor
16	6 ⁰ _{-0.012}	11	8	12	28	16	M6×1	8	—	0.6	4 ²⁾	—	12	4 050	4 200	510
19	8 ⁰ _{-0.015}	11	10	12	32	20	M8×1.25	10	—	0.6	4 ²⁾	—	14	4 750	5 400	660
22	10 ⁰ _{-0.015}	12	12	13	36	23	M10×1.25	12	—	0.6	4	—	17	5 300	6 650	810
26	10 ⁰ _{-0.015}	12	12	13	36	23	M10×1.25	12	—	0.6	4	—	17	5 300	6 650	810
30	12 ⁰ _{-0.018}	14	15	15	40	25	M12×1.5	13	6	0.6	6	3	23	7 850	9 650	1 180
32	12 ⁰ _{-0.018}	14	15	15	40	25	M12×1.5	13	6	0.6	6	3	23	7 850	9 650	1 180
35	16 ⁰ _{-0.018}	18	18	19.5	52	32.5	M16×1.5	17	8	0.8	6	3	27	12 200	17 900	2 180
40	18 ⁰ _{-0.018}	20	22	21.5	58	36.5	M18×1.5	19	8	0.8	6	3	32	14 000	22 800	2 780
47	20 ⁰ _{-0.021}	24	25	25.5	66	40.5	M20×1.5	21	9	0.8	8	4	37	20 700	33 500	4 100
52	20 ⁰ _{-0.021}	24	25	25.5	66	40.5	M20×1.5	21	9	0.8	8	4	37	20 700	33 500	4 100
62	24 ⁰ _{-0.021}	29	30	30.5	80	49.5	M24×1.5	25	11	0.8	8	4	44	28 900	55 000	6 700
72	24 ⁰ _{-0.021}	29	30	30.5	80	49.5	M24×1.5	25	11	0.8	8	4	44	28 900	55 000	6 700
80	30 ⁰ _{-0.021}	35	38	37	100	63	M30×1.5	32	15	1	8	4	53	45 000	88 500	10 800
85	30 ⁰ _{-0.021}	35	38	37	100	63	M30×1.5	32	15	1	8	4	53	45 000	88 500	10 800
90	30 ⁰ _{-0.021}	35	38	37	100	63	M30×1.5	32	15	1	8	4	53	45 000	88 500	10 800

1) The tolerance of outer ring outer diameter D of KR··X type and KR··XLL type having a cylindrical outer diameter surface is JIS 0 class.
2) A grease filler hole is provided only on the front surface (left side in the above drawing).

Needle Roller Bearings

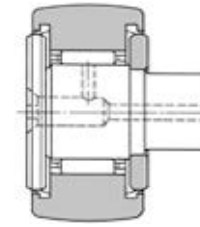

KR··LL type
(Seal type with cage)

Accessories

Applied bearing number	Grease nipple number	Plug number	Applied hexagonal nut
16~26	NIP-B4	SEN4	1M 6×1 ~1M10×1.25
30~40	NIP-B6	SEN3, SEN6	1M12×1.5~1M18×1.5
47~90	NIP-B8	SEN4, SEN8	1M20×1.5~1M30×1.5

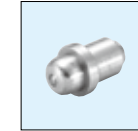

Grease fitting

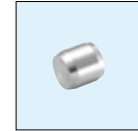

Plug

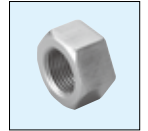

Hexagon nut

Track load capacity ²⁾ N		Allowable speed ³⁾ min ⁻¹		Maximum tightening torque N·m	Number				Mass kg (approx.)	Stud dia. mm
Spherical outer ring	Cylindrical outer ring	Grease lubrication	Oil lubrication		Without seal		With seal			
		Spherical outer ring	Cylindrical outer ring	Spherical outer ring	Cylindrical outer ring	Spherical outer ring	Cylindrical outer ring			
1 080	3 400	*19 000	*25 000	3	KR16F	KR16FX	KR16FLL/3AS	KR16FXLL/3AS	0.019	6
1 380	4 050	*15 000	*20 000	8	KR19F	KR19FX	KR19FLL/3AS	KR19FXLL/3AS	0.031	8
1 690	5 150	*12 000	*16 000	14	KR22F	KR22FX	KR22FLL/3AS	KR22FXLL/3AS	0.046	10
2 120	6 100	*12 000	*16 000	14	KR26F	KR26FX	KR26FLL/3AS	KR26FXLL/3AS	0.059	10
2 620	7 700	10 000	*13 000	20	KR30	KR30X	KR30LL/3AS	KR30XLL/3AS	0.087	12
2 860	8 200	10 000	*13 000	20	KR32	KR32X	KR32LL/3AS	KR32XLL/3AS	0.097	12
3 200	11 900	8 000	*11 000	52	KR35	KR35X	KR35LL/3AS	KR35XLL/3AS	0.169	16
3 850	14 500	7 000	9 000	76	KR40	KR40X	KR40LL/3AS	KR40XLL/3AS	0.248	18
4 700	21 000	6 000	8 000	98	KR47	KR47X	KR47LL/3AS	KR47XLL/3AS	0.386	20
5 550	23 300	6 000	8 000	98	KR52	KR52X	KR52LL/3AS	KR52XLL/3AS	0.461	20
6 950	34 500	5 000	6 500	178	KR62	KR62X	KR62LL/3AS	KR62XLL/3AS	0.790	24
8 050	38 500	5 000	6 500	178	KR72	KR72X	KR72LL/3AS	KR72XLL/3AS	1.04	24
9 800	53 000	4 000	5 500	360	KR80	KR80X	KR80LL/3AS	KR80XLL/3AS	1.55	30
10 400	56 000	4 000	5 500	360	KR85	KR85X	KR85LL/3AS	KR85XLL/3AS	1.74	30
11 400	59 000	4 000	5 500	360	KR90	KR90X	KR90LL/3AS	KR90XLL/3AS	1.95	30

3) The allowable speed of KR··LL type and KR··XLL type with a "*" mark seal is about 10 000 min⁻¹.

Needle Roller Bearings



Cam follower stud type track roller metric series

- KRV··H type
- KRV··XH type
- KRV··LLH type
- KRV··XLLH type

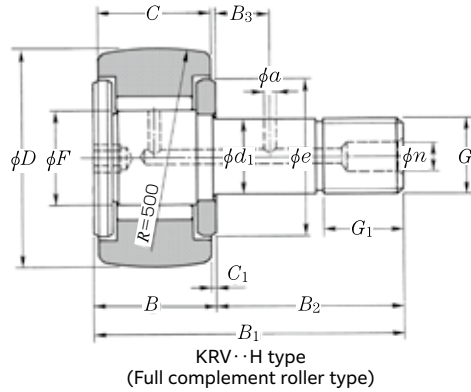
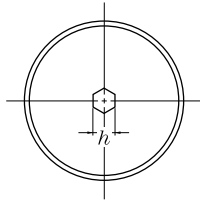

D 10 ~ 90mm

Outer dia. ¹⁾ mm D 0-0.05	Dimensions mm													Basic load rating		Fatigue load limit N Cu	
														dynamic	static		
	d ₁	C	F	B	B ₁	B ₂	G	G ₁	B ₃	C ₁	n	a	e	h	C _r		C _{0r}
10	3 ⁰ _{-0.010}	7	4	8	17	9	M3×0.5	5	—	0.5	—	—	7	2.5	2 500	2 610	320
12	4 ⁰ _{-0.012}	8	4.8	9	20	11	M4×0.7	6	—	0.5	—	—	8.5	2.5	3 500	3 800	460
13	5 ⁰ _{-0.012}	9	5.75	10	23	13	M5×0.8	7.5	—	0.5	—	—	9.5	3	4 500	5 350	650
16	6 ⁰ _{-0.012}	11	8	12	28	16	M6×1	8	—	0.6	—	—	12	3	6 500	9 350	1 140
19	8 ⁰ _{-0.015}	11	10	12	32	20	M8×1.25	10	—	0.6	—	—	14	4	7 450	11 700	1 430
22	10 ⁰ _{-0.015}	12	12	13	36	23	M10×1.25	12	—	0.6	4	—	17	4	8 200	14 000	1 700
26	10 ⁰ _{-0.015}	12	12	13	36	23	M10×1.25	12	—	0.6	4	—	17	4	8 200	14 000	1 700
30	12 ⁰ _{-0.018}	14	15	15	40	25	M12×1.5	13	6	0.6	6	3	23	6	12 000	20 300	2 470
32	12 ⁰ _{-0.018}	14	15	15	40	25	M12×1.5	13	6	0.6	6	3	23	6	12 000	20 300	2 470
35	16 ⁰ _{-0.018}	18	18	19.5	52	32.5	M16×1.5	17	8	0.8	6	3	27	6	17 600	34 000	4 150
40	18 ⁰ _{-0.018}	20	22	21.5	58	36.5	M18×1.5	19	8	0.8	6	3	32	6	19 400	42 000	5 100
47	20 ⁰ _{-0.021}	24	25	25.5	66	40.5	M20×1.5	21	9	0.8	8	4	37	8	28 800	61 000	7 450
52	20 ⁰ _{-0.021}	24	25	25.5	66	40.5	M20×1.5	21	9	0.8	8	4	37	8	28 800	61 000	7 450
62	24 ⁰ _{-0.021}	29	30	30.5	80	49.5	M24×1.5	25	11	0.8	8	4	44	8	39 500	98 500	12 000
72	24 ⁰ _{-0.021}	29	30	30.5	80	49.5	M24×1.5	25	11	0.8	8	4	44	8	39 500	98 500	12 000
80	30 ⁰ _{-0.021}	35	38	37	100	63	M30×1.5	32	15	1	8	4	53	8	58 000	147 000	18 000
90	30 ⁰ _{-0.021}	35	38	37	100	63	M30×1.5	32	15	1	8	4	53	8	58 000	147 000	18 000

1) The tolerance of outer ring outer diameter D of KRV··XH type and KRV··XLLH type having a cylindrical outer diameter surface is JIS 0 class.

Needle Roller Bearings

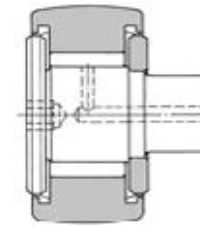

KRV··LLH type
(Full complement roller sealed type)

Accessories

Applied bearing number	Grease nipple number	Plug number	Applied hexagonal nut
10~19	—	—	1M3×0.5~1M8×1.25
22~26	NIP-B4	SEN4	1M10×1.25
30~40	NIP-B6	SEN3, SEN6	1M12×1.5~1M18×1.5
47~90	NIP-B8	SEN4, SEN8	1M20×1.5~1M30×1.5



Grease fitting

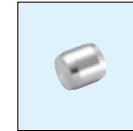

Plug

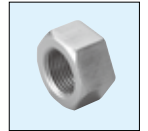

Hexagon nut

Track load capacity N		Allowable speed ²⁾ min ⁻¹		Maximum tightening torque N·m	Number				Mass kg (approx.)	Stud dia. mm
Spherical outer ring	Cylindrical outer ring	Grease lubrication	Oil lubrication		Without seal		With seal			
					Spherical outer ring	Cylindrical outer ring	Spherical outer ring	Cylindrical outer ring		
560	1 360	*25 000	*32 000	0.5	KRV10H/3AS	KRV10XH/3AS	KRV10LLH/3AS	KRV10XLLH/3AS	0.005	3
725	1 790	*20 000	*27 000	1	KRV12H/3AS	KRV12XH/3AS	KRV12LLH/3AS	KRV12XLLH/3AS	0.008	4
805	2 220	*17 000	*22 000	2	KRV13H/3AS	KRV13XH/3AS	KRV13LLH/3AS	KRV13XLLH/3AS	0.011	5
1 080	3 400	*13 000	*16 000	3	KRV16FD0H/L588	KRV16FXD0H/L588	KRV16FLLD0H/L588	KRV16FXLLD0H/L588	0.020	6
1 380	4 050	10 000	*13 000	8	KRV19FD0H/L588	KRV19FXD0H/L588	KRV19FLLD0H/L588	KRV19FXLLD0H/L588	0.032	8
1 690	5 150	8 500	*11 000	14	KRV22FH/3AS	KRV22FXH/3AS	KRV22FLH/3AS	KRV22FXLLH/3AS	0.047	10
2 120	6 100	8 500	*11 000	14	KRV26FH/3AS	KRV26FXH/3AS	KRV26FLH/3AS	KRV26FXLLH/3AS	0.061	10
2 620	7 700	6 500	8 500	20	KRV30H/3AS	KRV30XH/3AS	KRV30LLH/3AS	KRV30XLLH/3AS	0.089	12
2 860	8 200	6 500	8 500	20	KRV32H/3AS	KRV32XH/3AS	KRV32LLH/3AS	KRV32XLLH/3AS	0.100	12
3 200	11 900	5 500	7 000	52	KRV35H/3AS	KRV35XH/3AS	KRV35LLH/3AS	KRV35XLLH/3AS	0.172	16
3 850	14 500	4 500	6 000	76	KRV40H/3AS	KRV40XH/3AS	KRV40LLH/3AS	KRV40XLLH/3AS	0.252	18
4 700	21 000	4 000	5 000	98	KRV47H/3AS	KRV47XH/3AS	KRV47LLH/3AS	KRV47XLLH/3AS	0.392	20
5 550	23 300	4 000	5 000	98	KRV52H/3AS	KRV52XH/3AS	KRV52LLH/3AS	KRV52XLLH/3AS	0.465	20
6 950	34 500	3 300	4 500	178	KRV62H/3AS	KRV62XH/3AS	KRV62LLH/3AS	KRV62XLLH/3AS	0.800	24
8 050	38 500	3 300	4 500	178	KRV72H/3AS	KRV72XH/3AS	KRV72LLH/3AS	KRV72XLLH/3AS	1.05	24
9 800	53 000	2 600	3 500	360	KRV80H/3AS	KRV80XH/3AS	KRV80LLH/3AS	KRV80XLLH/3AS	1.56	30
11 400	59 000	2 600	3 500	360	KRV90H/3AS	KRV90XH/3AS	KRV90LLH/3AS	KRV90XLLH/3AS	1.97	30

2) The allowable speed of KRV··LLH type and KRV··XLLH type with a "*" mark seal is about 10 000 min⁻¹.

Needle Roller Bearings



Cam follower stud type track roller metric series

KRV type
KRV··X type
KRV··LL type
KRV··XLL type

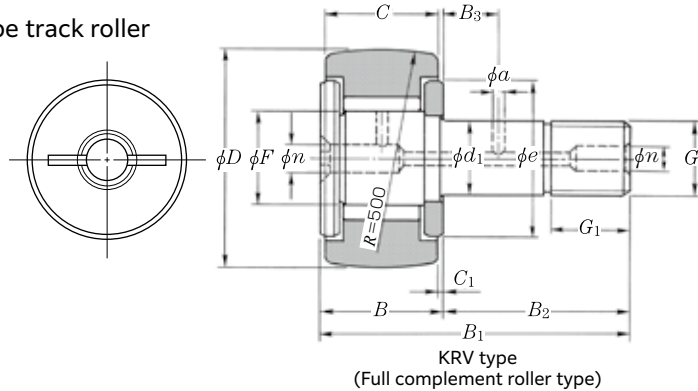

D 16 ~ 90mm

Outer dia. ¹⁾ mm D 0/-0.05	Dimensions mm													Basic load rating		Fatigue load limit N C _u
														dynamic	static	
	d ₁	C	F	B	B ₁	B ₂	G	G ₁	B ₃	C ₁	n	a	e	C _r	C _{0r}	
16	6 ⁰ _{-0.012}	11	8	12	28	16	M6×1	8	—	0.6	4 ²⁾	—	12	6 500	9 350	1 140
19	8 ⁰ _{-0.015}	11	10	12	32	20	M8×1.25	10	—	0.6	4 ²⁾	—	14	7 450	11 700	1 430
22	10 ⁰ _{-0.015}	12	12	13	36	23	M10×1.25	12	—	0.6	4	—	17	8 200	14 000	1 700
26	10 ⁰ _{-0.015}	12	12	13	36	23	M10×1.25	12	—	0.6	4	—	17	8 200	14 000	1 700
30	12 ⁰ _{-0.018}	14	15	15	40	25	M12×1.5	13	6	0.6	6	3	23	12 000	20 300	2 470
32	12 ⁰ _{-0.018}	14	15	15	40	25	M12×1.5	13	6	0.6	6	3	23	12 000	20 300	2 470
35	16 ⁰ _{-0.018}	18	18	19.5	52	32.5	M16×1.5	17	8	0.8	6	3	27	17 600	34 000	4 150
40	18 ⁰ _{-0.018}	20	22	21.5	58	36.5	M18×1.5	19	8	0.8	6	3	32	19 400	42 000	5 100
47	20 ⁰ _{-0.021}	24	25	25.5	66	40.5	M20×1.5	21	9	0.8	8	4	37	28 800	61 000	7 450
52	20 ⁰ _{-0.021}	24	25	25.5	66	40.5	M20×1.5	21	9	0.8	8	4	37	28 800	61 000	7 450
62	24 ⁰ _{-0.021}	29	30	30.5	80	49.5	M24×1.5	25	11	0.8	8	4	44	39 500	98 500	12 000
72	24 ⁰ _{-0.021}	29	30	30.5	80	49.5	M24×1.5	25	11	0.8	8	4	44	39 500	98 500	12 000
80	30 ⁰ _{-0.021}	35	38	37	100	63	M30×1.5	32	15	1	8	4	53	58 000	147 000	18 000
90	30 ⁰ _{-0.021}	35	38	37	100	63	M30×1.5	32	15	1	8	4	53	58 000	147 000	18 000

1) The tolerance of outer ring outer diameter D of KRV··X type and KRV··XLL type having a cylindrical outer diameter surface is JIS 0 class.
2) A grease filler hole is provided only on the front surface (left side in the above drawing).

Needle Roller Bearings

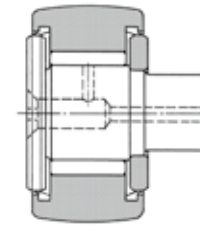

KRV··LL type
(Full complement roller sealed type)

Accessories

Applied bearing number	Grease nipple number	Plug number	Applied hexagonal nut
16~26	NIP-B4	SEN4	1M 6×1 ~1M10×1.25
30~40	NIP-B6	SEN3, SEN6	1M12×1.5~1M18×1.5
47~90	NIP-B8	SEN4, SEN8	1M20×1.5~1M30×1.5

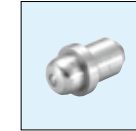

Grease fitting

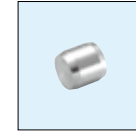

Plug

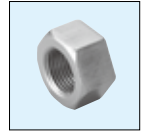

Hexagon nut

Track load capacity N	Allowable speed ³⁾ min ⁻¹	Maximum tightening torque N·m	Number				Mass kg (approx.)	Stud dia. mm		
			Without seal		With seal					
Spherical outer ring	Cylindrical outer ring	Grease lubrication	Oil lubrication	Spherical outer ring	Cylindrical outer ring	Spherical outer ring	Cylindrical outer ring			
1 080	3 400	*13 000	*16 000	3	KRV16F/3AS	KRV16FX/3AS	KRV16FLL/3AS	KRV16FLL/3AS	0.020	6
1 380	4 050	10 000	*13 000	8	KRV19F/3AS	KRV19FX/3AS	KRV19FLL/3AS	KRV19FLL/3AS	0.032	8
1 690	5 150	8 500	*11 000	14	KRV22F/3AS	KRV22FX/3AS	KRV22FLL/3AS	KRV22FLL/3AS	0.047	10
2 120	6 100	8 500	*11 000	14	KRV26F/3AS	KRV26FX/3AS	KRV26FLL/3AS	KRV26FLL/3AS	0.061	10
2 620	7 700	6 500	8 500	20	KRV30/3AS	KRV30X/3AS	KRV30LL/3AS	KRV30LL/3AS	0.089	12
2 860	8 200	6 500	8 500	20	KRV32/3AS	KRV32X/3AS	KRV32LL/3AS	KRV32LL/3AS	0.100	12
3 200	11 900	5 500	7 000	52	KRV35/3AS	KRV35X/3AS	KRV35LL/3AS	KRV35LL/3AS	0.172	16
3 850	14 500	4 500	6 000	76	KRV40/3AS	KRV40X/3AS	KRV40LL/3AS	KRV40LL/3AS	0.252	18
4 700	21 000	4 000	5 000	98	KRV47/3AS	KRV47X/3AS	KRV47LL/3AS	KRV47LL/3AS	0.390	20
5 550	23 300	4 000	5 000	98	KRV52/3AS	KRV52X/3AS	KRV52LL/3AS	KRV52LL/3AS	0.465	20
6 950	34 500	3 300	4 500	178	KRV62/3AS	KRV62X/3AS	KRV62LL/3AS	KRV62LL/3AS	0.800	24
8 050	38 500	3 300	4 500	178	KRV72/3AS	KRV72X/3AS	KRV72LL/3AS	KRV72LL/3AS	1.05	24
9 800	53 000	2 600	3 500	360	KRV80/3AS	KRV80X/3AS	KRV80LL/3AS	KRV80LL/3AS	1.56	30
11 400	59 000	2 600	3 500	360	KRV90/3AS	KRV90X/3AS	KRV90LL/3AS	KRV90LL/3AS	1.97	30

3) The allowable speed of KRV··LL type and KRV··XLL type with a "*" mark seal is about 10 000 min⁻¹.

Needle Roller Bearings



Cam follower stud type track roller metric series

- KRT type
- KRT·X type
- KRT·LL type
- KRT·XLL type

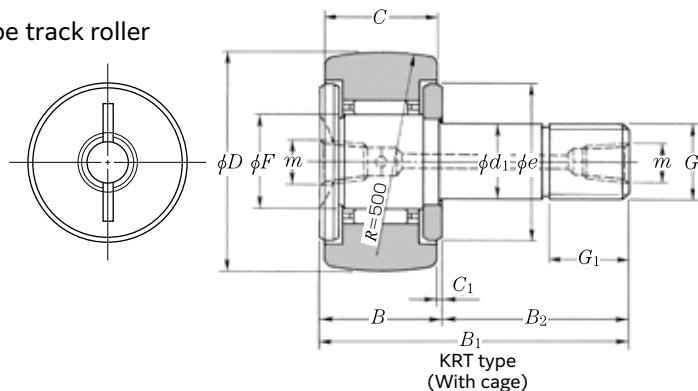

D 16 ~ 90mm

Outer dia. ¹⁾ mm D 0-0.05	Dimensions mm											Basic load rating		Fatigue load limit N C _u
	d ₁	C	F	B	B ₁	B ₂	G	G ₁	C ₁	m	e	C _r	C _{0r}	
16	6 ⁰ _{-0.012}	11	8	12	28	16	M6×1	8	0.6	M4×0.7 ²⁾	12	4 050	4 200	510
19	8 ⁰ _{-0.015}	11	10	12	32	20	M8×1.25	10	0.6	M4×0.7 ²⁾	14	4 750	5 400	660
22	10 ⁰ _{-0.015}	12	12	13	36	23	M10×1.25	12	0.6	M4×0.7	17	5 300	6 650	810
26	10 ⁰ _{-0.015}	12	12	13	36	23	M10×1.25	12	0.6	M4×0.7	17	5 300	6 650	810
30	12 ⁰ _{-0.018}	14	15	15	40	25	M12×1.5	13	0.6	M6×0.75	23	7 850	9 650	1 180
32	12 ⁰ _{-0.018}	14	15	15	40	25	M12×1.5	13	0.6	M6×0.75	23	7 850	9 650	1 180
35	16 ⁰ _{-0.018}	18	18	19.5	52	32.5	M16×1.5	17	0.8	Rc 1/8	27	12 200	17 900	2 180
40	18 ⁰ _{-0.018}	20	22	21.5	58	36.5	M18×1.5	19	0.8	Rc 1/8	32	14 000	22 800	2 785
47	20 ⁰ _{-0.021}	24	25	25.5	66	40.5	M20×1.5	21	0.8	Rc 1/8	37	20 700	33 500	4 100
52	20 ⁰ _{-0.021}	24	25	25.5	66	40.5	M20×1.5	21	0.8	Rc 1/8	37	20 700	33 500	4 100
62	24 ⁰ _{-0.021}	29	30	30.5	80	49.5	M24×1.5	25	0.8	Rc 1/8	44	28 900	55 000	6 700
72	24 ⁰ _{-0.021}	29	30	30.5	80	49.5	M24×1.5	25	0.8	Rc 1/8	44	28 900	55 000	6 700
80	30 ⁰ _{-0.021}	35	38	37	100	63	M30×1.5	32	1	Rc 1/8	53	45 000	88 500	10 800
85	30 ⁰ _{-0.021}	35	38	37	100	63	M30×1.5	32	1	Rc 1/8	53	45 000	88 500	10 800
90	30 ⁰ _{-0.021}	35	38	37	100	63	M30×1.5	32	1	Rc 1/8	53	45 000	88 500	10 800

1) The tolerance of outer ring outer diameter D of KRT·X type and KRT·XLL type having a cylindrical outer diameter surface is JIS 0 class.
2) A tapped hole is provided only on the front surface (left side in the above drawing).

Needle Roller Bearings

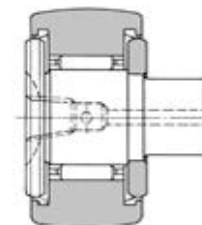

KRT·LL type
(Seal type with cage)

Accessories

Applied Number	Grease nipple number	Number of hex socket screw plug	Applied hexagonal nut Number
16~26	NIP-X30	M4×0.7 ×4 ℓ	1M 6×1 ~1M10×1.25
30~32	JIS 1 type (A-M6F)	M6×0.75 ×6 ℓ	1M12×1.5
35~90	JIS 2 type (A-PT1/8)	R ¹ / ₈ (PT ¹ / ₈) ×7 ℓ	1M16×1.5~1M30×1.5

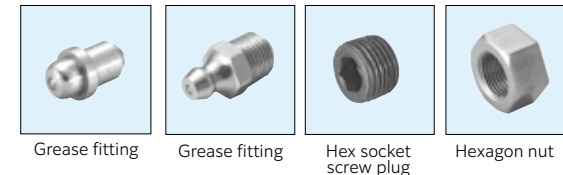

Track load capacity N		Allowable speed ³⁾ min ⁻¹		Maximum tightening torque N·m	Number				Mass kg (approx.)	Stud dia. mm
Spherical outer ring	Cylindrical outer ring	Grease lubrication	Oil lubrication		Without seal		With seal			
		Spherical outer ring	Cylindrical outer ring		Spherical outer ring	Cylindrical outer ring	Spherical outer ring	Cylindrical outer ring		
1 080	3 400	*19 000	*25 000	3	KRT16	KRT16X	KRT16LL/3AS	KRT16XLL/3AS	0.019	6
1 380	4 050	*15 000	*20 000	8	KRT19	KRT19X	KRT19LL/3AS	KRT19XLL/3AS	0.031	8
1 690	5 150	*12 000	*16 000	14	KRT22	KRT22X	KRT22LL/3AS	KRT22XLL/3AS	0.046	10
2 120	6 100	*12 000	*16 000	14	KRT26	KRT26X	KRT26LL/3AS	KRT26XLL/3AS	0.059	10
2 620	7 700	10 000	*13 000	20	KRT30	KRT30X	KRT30LL/3AS	KRT30XLL/3AS	0.087	12
2 860	8 200	10 000	*13 000	20	KRT32	KRT32X	KRT32LL/3AS	KRT32XLL/3AS	0.097	12
3 200	11 900	8 000	*11 000	52	KRT35	KRT35X	KRT35LL/3AS	KRT35XLL/3AS	0.169	16
3 850	14 500	7 000	9 000	76	KRT40	KRT40X	KRT40LL/3AS	KRT40XLL/3AS	0.248	18
4 700	21 000	6 000	8 000	98	KRT47	KRT47X	KRT47LL/3AS	KRT47XLL/3AS	0.386	20
5 550	23 300	6 000	8 000	98	KRT52	KRT52X	KRT52LL/3AS	KRT52XLL/3AS	0.461	20
6 950	34 500	5 000	6 500	178	KRT62	KRT62X	KRT62LL/3AS	KRT62XLL/3AS	0.790	24
8 050	38 500	5 000	6 500	178	KRT72	KRT72X	KRT72LL/3AS	KRT72XLL/3AS	1.04	24
9 800	53 000	4 000	5 500	360	KRT80	KRT80X	KRT80LL/3AS	KRT80XLL/3AS	1.55	30
10 400	56 000	4 000	5 500	360	KRT85	KRT85X	KRT85LL/3AS	KRT85XLL/3AS	1.74	30
11 400	59 000	4 000	5 500	360	KRT90	KRT90X	KRT90LL/3AS	KRT90XLL/3AS	1.95	30

3) The allowable speed of KRT·LL type and KRT·XLL type with a "*" mark seal is about 10 000 min⁻¹.

Needle Roller Bearings



Cam follower stud type track roller metric series

KRVT type
 KRVT··X type
 KRVT··LL type
 KRVT··XLL type

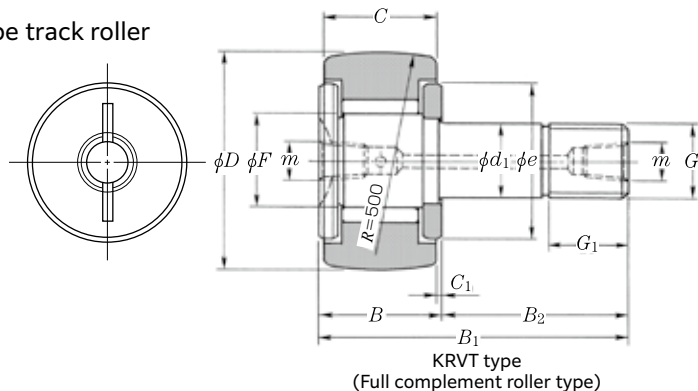

KRVT type
 (Full complement roller type)

D 16 ~ 90mm

Outer dia. ¹⁾ mm D 0/-0.05	Dimensions mm											Basic load rating		Fatigue load limit N C _u
	d ₁	C	F	B	B ₁	B ₂	G	G ₁	C ₁	m	e	d ₁	e	
16	6 ⁰ _{-0.012}	11	8	12	28	16	M6×1	8	0.6	M4×0.7 ²⁾	12	6 500	9 350	1 140
19	8 ⁰ _{-0.015}	11	10	12	32	20	M8×1.25	10	0.6	M4×0.7 ²⁾	14	7 450	11 700	1 430
22	10 ⁰ _{-0.015}	12	12	13	36	23	M10×1.25	12	0.6	M4×0.7	17	8 200	14 000	1 700
26	10 ⁰ _{-0.015}	12	12	13	36	23	M10×1.25	12	0.6	M4×0.7	17	8 200	14 000	1 700
30	12 ⁰ _{-0.018}	14	15	15	40	25	M12×1.5	13	0.6	M6×0.75	23	12 000	20 300	2 470
32	12 ⁰ _{-0.018}	14	15	15	40	25	M12×1.5	13	0.6	M6×0.75	23	12 000	20 300	2 470
35	16 ⁰ _{-0.018}	18	18	19.5	52	32.5	M16×1.5	17	0.8	Rc 1/8	27	17 600	34 000	4 150
40	18 ⁰ _{-0.018}	20	22	21.5	58	36.5	M18×1.5	19	0.8	Rc 1/8	32	19 400	42 000	5 100
47	20 ⁰ _{-0.021}	24	25	25.5	66	40.5	M20×1.5	21	0.8	Rc 1/8	37	28 800	61 000	7 450
52	20 ⁰ _{-0.021}	24	25	25.5	66	40.5	M20×1.5	21	0.8	Rc 1/8	37	28 800	61 000	7 450
62	24 ⁰ _{-0.021}	29	30	30.5	80	49.5	M24×1.5	25	0.8	Rc 1/8	44	39 500	98 500	12 000
72	24 ⁰ _{-0.021}	29	30	30.5	80	49.5	M24×1.5	25	0.8	Rc 1/8	44	39 500	98 500	12 000
80	30 ⁰ _{-0.021}	35	38	37	100	63	M30×1.5	32	1	Rc 1/8	53	58 000	147 000	18 000
90	30 ⁰ _{-0.021}	35	38	37	100	63	M30×1.5	32	1	Rc 1/8	53	58 000	147 000	18 000

1) The tolerance of outer ring outer diameter D of KRVT··X type and KRVT··XLL type having a cylindrical outer diameter surface is JIS 0 class.
 2) A tapped hole is provided only on the front surface (left side in the above drawing).

Needle Roller Bearings

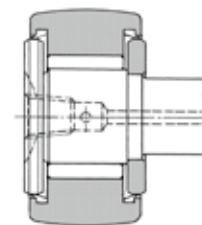

KRVT··LL type
 (Full complement roller sealed type)

Accessories

Applied Number	Grease nipple number	Number of hex socket screw plug	Applied hexagonal nut Number
16~26	NIP-X30	M4×0.7 x4 ℓ	1M 6×1 ~1M10×1.25
30~32	JIS 1 type (A-M6F)	M6×0.75 x6 ℓ	1M12×1.5
35~90	JIS 2 type (A-PT1/8)	R ¹ / ₈ (PT ¹ / ₈) x7 ℓ	1M16×1.5~1M30×1.5

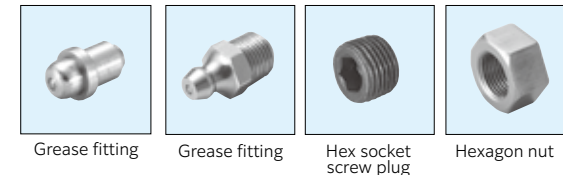

Track load capacity N		Allowable speed ³⁾ min ⁻¹		Maximum tightening torque N·m	Number				Mass kg (approx.)	Stud dia. mm
Spherical outer ring	Cylindrical outer ring	Grease lubrication	Oil lubrication		Without seal		With seal			
					Spherical outer ring	Cylindrical outer ring	Spherical outer ring	Cylindrical outer ring		
1 080	3 400	*13 000	*16 000	3	KRVT16/3AS	KRVT16X/3AS	KRVT16LL/3AS	KRVT16XLL/3AS	0.020	6
1 380	4 050	10 000	*13 000	8	KRVT19/3AS	KRVT19X/3AS	KRVT19LL/3AS	KRVT19XLL/3AS	0.032	8
1 690	5 150	8 500	*11 000	14	KRVT22/3AS	KRVT22X/3AS	KRVT22LL/3AS	KRVT22XLL/3AS	0.047	10
2 120	6 100	8 500	*11 000	14	KRVT26/3AS	KRVT26X/3AS	KRVT26LL/3AS	KRVT26XLL/3AS	0.061	10
2 620	7 700	6 500	8 500	20	KRVT30/3AS	KRVT30X/3AS	KRVT30LL/3AS	KRVT30XLL/3AS	0.089	12
2 860	8 200	6 500	8 500	20	KRVT32/3AS	KRVT32X/3AS	KRVT32LL/3AS	KRVT32XLL/3AS	0.100	12
3 200	11 900	5 500	7 000	52	KRVT35/3AS	KRVT35X/3AS	KRVT35LL/3AS	KRVT35XLL/3AS	0.172	16
3 850	14 500	4 500	6 000	76	KRVT40/3AS	KRVT40X/3AS	KRVT40LL/3AS	KRVT40XLL/3AS	0.252	18
4 700	21 000	4 000	5 000	98	KRVT47/3AS	KRVT47X/3AS	KRVT47LL/3AS	KRVT47XLL/3AS	0.390	20
5 550	23 300	4 000	5 000	98	KRVT52/3AS	KRVT52X/3AS	KRVT52LL/3AS	KRVT52XLL/3AS	0.465	20
6 950	34 500	3 300	4 500	178	KRVT62/3AS	KRVT62X/3AS	KRVT62LL/3AS	KRVT62XLL/3AS	0.800	24
8 050	38 500	3 300	4 500	178	KRVT72/3AS	KRVT72X/3AS	KRVT72LL/3AS	KRVT72XLL/3AS	1.05	24
9 800	53 000	2 600	3 500	360	KRVT80/3AS	KRVT80X/3AS	KRVT80LL/3AS	KRVT80XLL/3AS	1.56	30
11 400	59 000	2 600	3 500	360	KRVT90/3AS	KRVT90X/3AS	KRVT90LL/3AS	KRVT90XLL/3AS	1.97	30

3) The allowable speed of KRVT··LL type and KRVT··XLL type with a "*" mark seal is about 10 000 min⁻¹.

Needle Roller Bearings



Cam follower stud type track roller metric series

NUKR··H type
NUKR··XH type

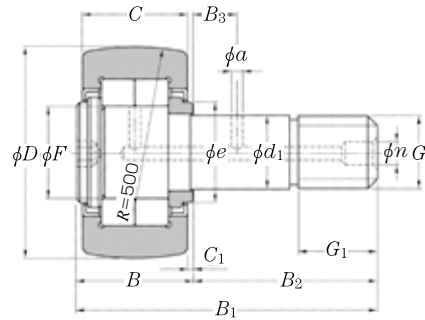
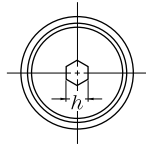

NUKR··H type ($D < 100$ mm)
(Full complement double-row cylindrical roller bearings with shield)

D 30 ~ 180mm

Outer dia. ¹⁾ mm D 0/-0.05	Dimensions mm															Fatigue load limit N C_{11}
	d_1	C	F	B	B_1	B_2	G	G_1	B_3	C_1	n	m	a	e	h	
30	12 ⁰ _{-0.018}	14	14.5	15	40	25	M12×1.5	13	6	0.6	6	—	3	15	6	1 650
35	16 ⁰ _{-0.018}	18	19	19.5	52	32.5	M16×1.5	17	8	0.8	6	—	3	21	6	3 150
40	18 ⁰ _{-0.018}	20	21.5	21.5	58	36.5	M18×1.5	19	8	0.8	6	—	3	23	6	3 550
47	20 ⁰ _{-0.021}	24	25.5	25.5	66	40.5	M20×1.5	21	9	0.8	8	—	4	27	8	5 900
52	20 ⁰ _{-0.021}	24	30	25.5	66	40.5	M20×1.5	21	9	0.8	8	—	4	31	8	7 000
62	24 ⁰ _{-0.021}	29	35	30.5	80	49.5	M24×1.5	25	11	0.8	8	—	4	38	8	8 850
72	24 ⁰ _{-0.021}	29	41.5	30.5	80	49.5	M24×1.5	25	11	0.8	8	—	4	44	8	10 400
80	30 ⁰ _{-0.021}	35	47.5	37	100	63	M30×1.5	32	15	1	8	—	4	51	8	18 400
90	30 ⁰ _{-0.021}	35	47.5	37	100	63	M30×1.5	32	15	1	8	—	4	51	8	18 400
100	36 ⁰ _{-0.025}	43	48.5	46	120	74	M36×1.5	38	—	1.5	—	Rc 1/8	—	53	14	20 400
120	42 ⁰ _{-0.025}	50	60.5	53	140	87	M42×1.5	44	—	1.5	—	Rc 1/8	—	66	14	32 400
140	48 ⁰ _{-0.025}	57	65	60	160	100	M48×1.5	52	—	1.5	—	Rc 1/8	—	72.5	14	35 900
150	52 ⁰ _{-0.030}	60	75.5	63	170	107	M52×1.5	52	—	1.5	—	Rc 1/8	—	85.5	17	46 500
160	56 ⁰ _{-0.030}	63	80.5	67	180	113	M56×3	58	—	2	—	Rc 1/8	—	89.5	17	49 000
170	60 ⁰ _{-0.030}	66	86	70	190	120	M60×3	58	—	2	—	Rc 1/8	—	96.5	17	58 000
180	64 ⁰ _{-0.030}	72	91.5	76	200	124	M64×3	65	—	2	—	Rc 1/8	—	103.5	17	67 500

1) The tolerance of outer ring outer diameter D of NUKR··XH type having a cylindrical outer diameter surface is JIS 0 class.

Needle Roller Bearings



Accessories

Applied Number	Grease nipple number	Plug Number	Applied hexagonal nut
30~40	NIP-B6	SEN3, SEN6	1M12x1.5~1M18x1.5
47~90	NIP-B8	SEN4, SEN8	1M20x1.5~1M30x1.5
100~180	JIS 2 type (A-PT1/8)	—	1M36x1.5~1M64x3

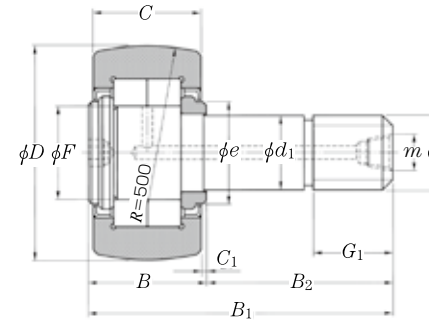

NUKR··H type ($D \geq 100$ mm)

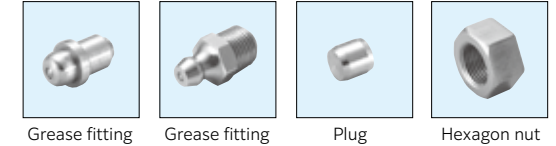

Basic load rating dynamic C_r	static C_{0r}	Track load capacity N		Allowable speed min ⁻¹ Grease lubrication	Maximum tightening torque N·m	Number		Mass kg (approx.)	Stud dia. mm
		Spherical outer ring	Cylindrical outer ring			Spherical outer ring	Cylindrical outer ring		
13 300	13 500	2 620	7 700	6 900	20	NUKR30H/3AS	NUKR30XH/3AS	0.088	12
22 300	25 700	3 200	11 900	5 500	52	NUKR35H/3AS	NUKR35XH/3AS	0.165	16
24 100	29 100	3 850	14 500	4 700	76	NUKR40H/3AS	NUKR40XH/3AS	0.242	18
38 500	48 000	4 700	21 000	4 000	98	NUKR47H/3AS	NUKR47XH/3AS	0.380	20
42 500	57 500	5 550	23 300	3 300	98	NUKR52H/3AS	NUKR52XH/3AS	0.450	20
56 500	72 500	6 950	34 500	2 900	178	NUKR62H/3AS	NUKR62XH/3AS	0.795	24
62 000	85 500	8 050	38 500	2 400	178	NUKR72H/3AS	NUKR72XH/3AS	1.01	24
101 000	151 000	9 800	53 000	2 100	360	NUKR80H/3AS	NUKR80XH/3AS	1.54	30
101 000	151 000	11 400	59 000	2 100	360	NUKR90H/3AS	NUKR90XH/3AS	1.96	30
119 000	167 000	13 000	79 000	2 000	630	NUKR100H/3AS	NUKR100XH/3AS	3.08	36
172 000	266 000	16 400	113 000	1 700	1 020	NUKR120H/3AS	NUKR120XH/3AS	5.17	42
201 000	294 000	20 000	152 000	1 500	1 540	NUKR140H/3AS	NUKR140XH/3AS	7.98	48
258 000	380 000	22 000	173 000	1 300	1 950	NUKR150H/3AS	NUKR150XH/3AS	9.70	52
274 000	400 000	24 000	194 000	1 200	2 480	NUKR160H/3AS	NUKR160XH/3AS	11.7	56
320 000	475 000	26 000	218 000	1 100	3 030	NUKR170H/3AS	NUKR170XH/3AS	13.9	60
365 000	555 000	27 900	253 000	1 000	3 670	NUKR180H/3AS	NUKR180XH/3AS	17.0	64

Needle Roller Bearings



Cam follower stud type track roller metric series

NUKR type
NUKR·X type

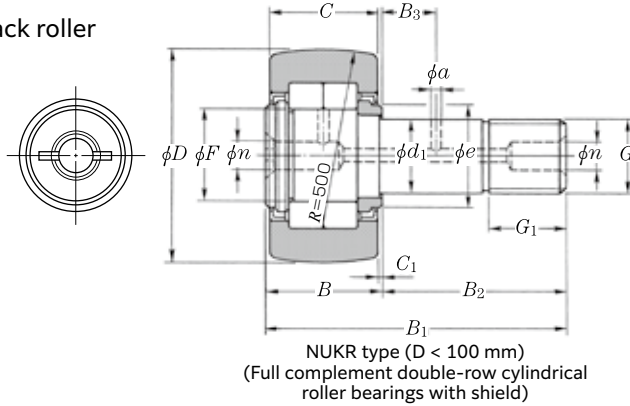

D 30 ~ 180mm

Outer dia. ¹⁾ mm D 0 -0.05	Dimensions mm													Fatigue load limit N C_u	
	d_1	C	F	B	B_1	B_2	G	G_1	B_3	C_1	n	m	a		e
30	12 ⁰ _{-0.018}	14	14.5	15	40	25	M12×1.5	13	6	0.6	6	—	3	15	1 650
35	16 ⁰ _{-0.018}	18	19	19.5	52	32.5	M16×1.5	17	8	0.8	6	—	3	21	3 150
40	18 ⁰ _{-0.018}	20	21.5	21.5	58	36.5	M18×1.5	19	8	0.8	6	—	3	23	3 550
47	20 ⁰ _{-0.021}	24	25.5	25.5	66	40.5	M20×1.5	21	9	0.8	8	—	4	27	5 900
52	20 ⁰ _{-0.021}	24	30	25.5	66	40.5	M20×1.5	21	9	0.8	8	—	4	31	7 000
62	24 ⁰ _{-0.021}	29	35	30.5	80	49.5	M24×1.5	25	11	0.8	8	—	4	38	8 850
72	24 ⁰ _{-0.021}	29	41.5	30.5	80	49.5	M24×1.5	25	11	0.8	8	—	4	44	10 400
80	30 ⁰ _{-0.021}	35	47.5	37	100	63	M30×1.5	32	15	1	8	—	4	51	18 400
90	30 ⁰ _{-0.021}	35	47.5	37	100	63	M30×1.5	32	15	1	8	—	4	51	18 400
100	36 ⁰ _{-0.025}	43	48.5	46	120	74	M36×1.5	38	—	1.5	8	Rc 1/8	—	53	20 400
120	42 ⁰ _{-0.025}	50	60.5	53	140	87	M42×1.5	44	—	1.5	8	Rc 1/8	—	66	32 500
140	48 ⁰ _{-0.025}	57	65	60	160	100	M48×1.5	52	—	1.5	8	Rc 1/8	—	72.5	36 000
150	52 ⁰ _{-0.030}	60	75.5	63	170	107	M52×1.5	52	—	1.5	8	Rc 1/8	—	85.5	46 500
160	56 ⁰ _{-0.030}	63	80.5	67	180	113	M56×3	58	—	2	8	Rc 1/8	—	89.5	49 000
170	60 ⁰ _{-0.030}	66	86	70	190	120	M60×3	58	—	2	8	Rc 1/8	—	96.5	58 000
180	64 ⁰ _{-0.030}	72	91.5	76	200	124	M64×3	65	—	2	8	Rc 1/8	—	103.5	67 500

1) The tolerance of outer ring outer diameter D of NUKR·X type having a cylindrical outer diameter surface is JIS 0 class.

Needle Roller Bearings

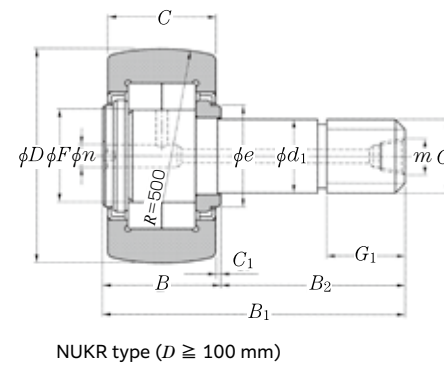

Accessories

Applied Number	Grease nipple number	Plug Number	Applied hexagonal nut
30~40	NIP-B6	SEN3, SEN6	1M12x1.5~1M18x1.5
47~90	NIP-B8	SEN4, SEN8	1M20x1.5~1M30x1.5
100~180	JIS 2 type (A-PT1/8)	—	1M36x1.5~1M64x3



Grease fitting

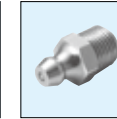

Grease fitting

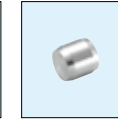

Plug

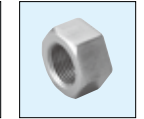

Hexagon nut

Basic load rating dynamic N C_r	Basic load rating static N C_{0r}	Track load capacity N		Allowable speed min ⁻¹ Grease lubrication	Maximum tightening torque N · m	Number		Mass kg (approx.)	Stud dia. mm
		Spherical outer ring	Cylindrical outer ring			Spherical outer ring	Cylindrical outer ring		
13 300	13 500	2 620	7 700	6 900	20	NUKR 30/3AS	NUKR 30X/3AS	0.088	12
22 300	25 700	3 200	11 900	5 500	52	NUKR 35/3AS	NUKR 35X/3AS	0.165	16
24 100	29 100	3 850	14 500	4 700	76	NUKR 40/3AS	NUKR 40X/3AS	0.242	18
38 500	48 000	4 700	21 000	4 000	98	NUKR 47/3AS	NUKR 47X/3AS	0.380	20
42 500	57 500	5 550	23 300	3 300	98	NUKR 52/3AS	NUKR 52X/3AS	0.450	20
56 500	72 500	6 950	34 500	2 900	178	NUKR 62/3AS	NUKR 62X/3AS	0.795	24
62 000	85 500	8 050	38 500	2 400	178	NUKR 72/3AS	NUKR 72X/3AS	1.01	24
101 000	151 000	9 800	53 000	2 100	360	NUKR 80/3AS	NUKR 80X/3AS	1.54	30
101 000	151 000	11 400	59 000	2 100	360	NUKR 90/3AS	NUKR 90X/3AS	1.96	30
119 000	167 000	13 000	79 000	2 000	630	NUKR 100/3AS	NUKR 100X/3AS	3.08	36
172 000	266 000	16 400	113 000	1 700	1 020	NUKR 120/3AS	NUKR 120X/3AS	5.17	42
201 000	294 000	20 000	152 000	1 500	1 540	NUKR 140/3AS	NUKR 140X/3AS	7.98	48
258 000	380 000	22 000	173 000	1 300	1 950	NUKR 150/3AS	NUKR 150X/3AS	9.70	52
274 000	400 000	24 000	194 000	1 200	2 480	NUKR 160/3AS	NUKR 160X/3AS	11.7	56
320 000	475 000	26 000	218 000	1 100	3 030	NUKR 170/3AS	NUKR 170X/3AS	13.9	60
365 000	555 000	27 900	253 000	1 000	3 670	NUKR 180/3AS	NUKR 180X/3AS	17.0	64

Needle Roller Bearings



Cam follower stud type track roller
metric series

NUKRT type
NUKRT··X type

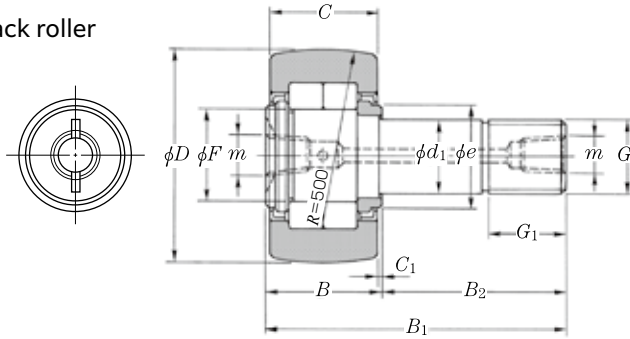

NUKRT type
(Full complement double-row cylindrical roller bearings with shield)

D 30 ~ 180mm

Outer dia. ¹⁾ mm D 0 -0.05	Dimensions mm											Basic load rating		Fatigue load limit N C _u
	d ₁	C	F	B	B ₁	B ₂	G	G ₁	C ₁	m	e	C _r	C _{0r}	
30	12 ⁰ _{-0.018}	14	14.5	15	40	25	M12×1.5	13	0.6	M6×0.75	15	13 300	13 500	1 650
35	16 ⁰ _{-0.018}	18	19	19.5	52	32.5	M16×1.5	17	0.8	Rc 1/8	21	22 300	25 700	3 150
40	18 ⁰ _{-0.018}	20	21.5	21.5	58	36.5	M18×1.5	19	0.8	Rc 1/8	23	24 100	29 100	3 550
47	20 ⁰ _{-0.021}	24	25.5	25.5	66	40.5	M20×1.5	21	0.8	Rc 1/8	27	38 500	48 000	5 900
52	20 ⁰ _{-0.021}	24	30	25.5	66	40.5	M20×1.5	21	0.8	Rc 1/8	31	42 500	57 500	7 000
62	24 ⁰ _{-0.021}	29	35	30.5	80	49.5	M24×1.5	25	0.8	Rc 1/8	38	56 500	72 500	8 850
72	24 ⁰ _{-0.021}	29	41.5	30.5	80	49.5	M24×1.5	25	0.8	Rc 1/8	44	62 000	85 500	10 400
80	30 ⁰ _{-0.021}	35	47.5	37	100	63	M30×1.5	32	1	Rc 1/8	51	101 000	151 000	18 400
90	30 ⁰ _{-0.021}	35	47.5	37	100	63	M30×1.5	32	1	Rc 1/8	51	101 000	151 000	18 400
100	36 ⁰ _{-0.025}	43	48.5	46	120	74	M36×1.5	38	1.5	Rc 1/8	53	119 000	167 000	20 400
120	42 ⁰ _{-0.025}	50	60.5	53	140	87	M42×1.5	44	1.5	Rc 1/8	66	172 000	266 000	32 500
140	48 ⁰ _{-0.025}	57	65	60	160	100	M48×1.5	52	1.5	Rc 1/8	72.5	201 000	294 000	36 000
150	52 ⁰ _{-0.030}	60	75.5	63	170	107	M52×1.5	52	1.5	Rc 1/8	85.5	258 000	380 000	46 500
160	56 ⁰ _{-0.030}	63	80.5	67	180	113	M56×3	58	2	Rc 1/8	89.5	274 000	400 000	49 000
170	60 ⁰ _{-0.030}	66	86	70	190	120	M60×3	58	2	Rc 1/8	96.5	320 000	475 000	58 000
180	64 ⁰ _{-0.030}	72	91.5	76	200	124	M64×3	65	2	Rc 1/8	103.5	365 000	555 000	67 500

1) The tolerance of outer ring outer diameter D of NUKRT··X type having a cylindrical outer diameter surface is JIS 0 class.

Needle Roller Bearings



Accessories

Applied Number	Grease nipple number	Number of hex socket screw plug	Applied hexagonal nut
30	JIS 1 type (A-M6F)	M6×0.75×6 ℓ	1M12×1.5
35~180	JIS 2 type (A-PT1/8)	R3/8(PT1/8)×7 ℓ	1M16×1.5~1M64×3

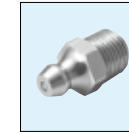

Grease fitting

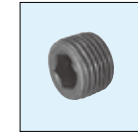

Hex socket screw plug

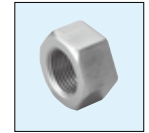

Hexagon nut

Track load capacity N		Allowable speed min ⁻¹ Grease lubrication	Maximum tightening torque N · m	Number		Mass kg (approx.)	Stud dia. mm
Spherical outer ring	Cylindrical outer ring			Spherical outer ring	Cylindrical outer ring		
2 620	7 700	6 900	20	NUKRT 30/3AS	NUKRT 30X/3AS	0.088	12
3 200	11 900	5 500	52	NUKRT 35/3AS	NUKRT 35X/3AS	0.165	16
3 850	14 500	4 700	76	NUKRT 40/3AS	NUKRT 40X/3AS	0.242	18
4 700	21 000	4 000	98	NUKRT 47/3AS	NUKRT 47X/3AS	0.380	20
5 550	23 300	3 300	98	NUKRT 52/3AS	NUKRT 52X/3AS	0.450	20
6 950	34 500	2 900	178	NUKRT 62/3AS	NUKRT 62X/3AS	0.795	24
8 050	38 500	2 400	178	NUKRT 72/3AS	NUKRT 72X/3AS	1.01	24
9 800	53 000	2 100	360	NUKRT 80/3AS	NUKRT 80X/3AS	1.54	30
11 400	59 000	2 100	360	NUKRT 90/3AS	NUKRT 90X/3AS	1.96	30
13 000	79 000	2 000	630	NUKRT 100/3AS	NUKRT 100X/3AS	3.08	36
16 400	113 000	1 700	1 020	NUKRT 120/3AS	NUKRT 120X/3AS	5.17	42
20 000	152 000	1 500	1 540	NUKRT 140/3AS	NUKRT 140X/3AS	7.98	48
22 000	173 000	1 300	1 950	NUKRT 150/3AS	NUKRT 150X/3AS	9.70	52
24 000	194 000	1 200	2 480	NUKRT 160/3AS	NUKRT 160X/3AS	11.7	56
26 000	218 000	1 100	3 030	NUKRT 170/3AS	NUKRT 170X/3AS	13.9	60
27 900	253 000	1 000	3 670	NUKRT 180/3AS	NUKRT 180X/3AS	17.0	64

Roller follower yoke type track roller
metric series

NATR type
NATR·X type
NATR·LL type
NATR·XLL type

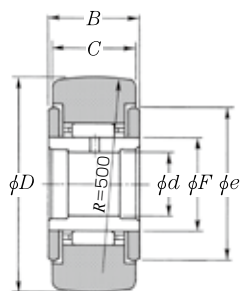

NATR type
(With cage)

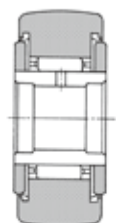

NATR·LL type
(Seal type with cage)

D 16 ~ 90mm

Outer dia. ¹⁾ mm D _{-0.05}	Dimensions mm						Basic load rating		Track load capacity		Fatigue load limit N C_u
	d	B	C	e	F	dynamic C_r	static C_{0r}	Spherical outer ring	Cylindrical outer ring		
16	5	12 _{-0.180}	11	12	8	4 050	4 200	1 080	3 400	510	
19	6	12 _{-0.180}	11	14	10	4 750	5 400	1 380	4 050	660	
24	8	15 _{-0.180}	14	19	12	6 900	7 700	1 900	6 650	940	
30	10	15 _{-0.180}	14	23	15	7 850	9 650	2 620	7 700	1 180	
32	12	15 _{-0.180}	14	25	17	8 400	10 900	2 860	8 200	1 330	
35	15	19 _{-0.210}	18	27	20	13 300	20 800	3 200	11 900	2 530	
40	17	21 _{-0.210}	20	32	22	14 000	22 800	3 850	14 500	2 790	
47	20	25 _{-0.210}	24	37	25	20 700	33 500	4 700	21 000	4 100	
52	25	25 _{-0.210}	24	42	30	22 800	40 500	5 500	23 300	4 950	
62	30	29 _{-0.210}	28	51	38	36 000	66 000	6 950	33 000	8 100	
72	35	29 _{-0.210}	28	58	44.5	39 000	77 000	8 050	37 000	9 400	
80	40	32 _{-0.250}	30	66	50	49 500	92 500	9 800	44 500	11 300	
85	45	32 _{-0.250}	30	71	55	51 500	100 000	10 400	47 000	12 200	
90	50	32 _{-0.250}	30	76	60	53 000	108 000	11 400	50 000	13 200	

1) The tolerance of outer ring outer diameter D of NATR·X type and NATR·XLL type having a cylindrical outer diameter surface is JIS 0 class.

Allowable speed ²⁾ min ⁻¹		Number				Mass kg (approx.)	Outer dia. ¹⁾ mm D _{-0.05}
Grease lubrication	Oil lubrication	Without seal Spherical outer ring	Cylindrical outer ring	With seal Spherical outer ring	Cylindrical outer ring		
*19 000	*25 000	NATR5	NATR5X	NATR5LL/3AS	NATR5XLL/3AS	0.018	16
*15 000	*20 000	NATR6	NATR6X	NATR6LL/3AS	NATR6XLL/3AS	0.025	19
*12 000	*16 000	NATR8	NATR8X	NATR8LL/3AS	NATR8XLL/3AS	0.042	24
10 000	*13 000	NATR10	NATR10X	NATR10LL/3AS	NATR10XLL/3AS	0.061	30
9 000	*12 000	NATR12CT	NATR12XCT	NATR12CLLT/3AS	NATR12CXLLT/3AS	0.069	32
7 500	10 000	NATR15	NATR15X	NATR15LL/3AS	NATR15XLL/3AS	0.098	35
7 000	9 000	NATR17	NATR17X	NATR17LL/3AS	NATR17XLL/3AS	0.140	40
6 000	8 000	NATR20	NATR20X	NATR20LL/3AS	NATR20XLL/3AS	0.246	47
5 000	6 500	NATR25	NATR25X	NATR25LL/3AS	NATR25XLL/3AS	0.275	52
4 000	5 500	NATR30	NATR30X	NATR30LL/3AS	NATR30XLL/3AS	0.470	62
3 300	4 500	NATR35	NATR35X	NATR35LL/3AS	NATR35XLL/3AS	0.635	72
3 000	4 000	NATR40	NATR40X	NATR40LL/3AS	NATR40XLL/3AS	0.875	80
2 700	3 600	NATR45	NATR45X	NATR45LL/3AS	NATR45XLL/3AS	0.910	85
2 500	3 300	NATR50	NATR50X	NATR50LL/3AS	NATR50XLL/3AS	0.960	90

2) The allowable speed of bearings with a "*" mark seal is about 10 000 min⁻¹.

Roller follower yoke type track roller
metric series

NATV type
NATV··X type
NATV··LL type
NATV··XLL type

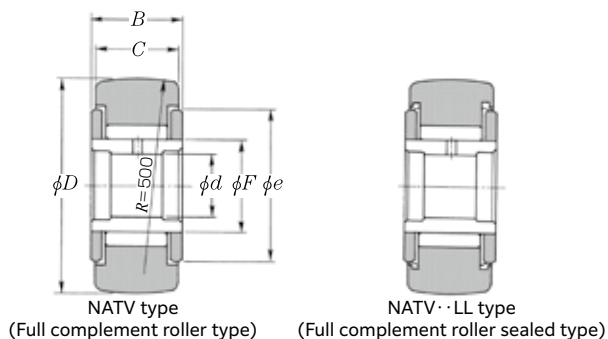

D 16 ~ 90mm

Outer dia. ¹⁾ mm D _{-0.05}	Dimensions mm						Basic load rating		Track load capacity		Fatigue load limit N C_u
	d	B	C	e	F	dynamic C_r	static C_{0r}	Spherical outer ring	Cylindrical outer ring		
16	5	12 _{-0.180}	11	12	8	6 500	9 350	1 080	3 400	1 140	
19	6	12 _{-0.180}	11	14	10	7 450	11 700	1 380	4 050	1 430	
24	8	15 _{-0.180}	14	19	12	10 700	16 200	1 900	6 650	1 980	
30	10	15 _{-0.180}	14	23	15	12 000	20 300	2 620	7 700	2 470	
32	12	15 _{-0.180}	14	25	17	13 000	23 000	2 860	8 200	2 810	
35	15	19 _{-0.210}	18	27	20	18 400	38 000	3 200	11 900	4 650	
40	17	21 _{-0.210}	20	32	22	19 400	42 000	3 850	14 500	5 100	
47	20	25 _{-0.210}	24	37	25	28 800	61 000	4 700	21 000	7 450	
52	25	25 _{-0.210}	24	42	30	31 500	73 500	5 500	23 300	8 950	
62	30	29 _{-0.210}	28	51	38	47 500	115 000	6 950	33 000	14 000	
72	35	29 _{-0.210}	28	58	44.5	52 000	134 000	8 050	37 000	16 300	
80	40	32 _{-0.250}	30	66	50	68 500	171 000	9 800	44 500	20 900	
90	50	32 _{-0.250}	30	76	60	76 000	205 000	11 400	50 000	25 000	

1) The tolerance of outer ring outer diameter D of NATV··X type and NATV··XLL type having a cylindrical outer diameter surface is JIS 0 class.

Allowable speed ²⁾ min ⁻¹		Number				Mass kg (approx.)	Outer dia. ¹⁾ mm D _{-0.05}
Grease lubrication	Oil lubrication	Without seal		With seal			
		Spherical outer ring	Cylindrical outer ring	Spherical outer ring	Cylindrical outer ring		
*13 000	*16 000	NATV5/3AS	NATV5X/3AS	NATV5LL/3AS	NATV5XLL/3AS	0.020	16
10 000	*13 000	NATV6/3AS	NATV6X/3AS	NATV6LL/3AS	NATV6XLL/3AS	0.027	19
8 500	*11 000	NATV8/3AS	NATV8X/3AS	NATV8LL/3AS	NATV8XLL/3AS	0.044	24
6 500	8 500	NATV10/3AS	NATV10X/3AS	NATV10LL/3AS	NATV10XLL/3AS	0.065	30
6 000	7 500	NATV12/3AS	NATV12X/3AS	NATV12LL/3AS	NATV12XLL/3AS	0.074	32
5 000	6 500	NATV15/3AS	NATV15X/3AS	NATV15LL/3AS	NATV15XLL/3AS	0.102	35
4 500	6 000	NATV17/3AS	NATV17X/3AS	NATV17LL/3AS	NATV17XLL/3AS	0.145	40
4 000	5 000	NATV20/3AS	NATV20X/3AS	NATV20LL/3AS	NATV20XLL/3AS	0.254	47
3 300	4 500	NATV25/3AS	NATV25X/3AS	NATV25LL/3AS	NATV25XLL/3AS	0.285	52
2 600	3 500	NATV30/3AS	NATV30X/3AS	NATV30LL/3AS	NATV30XLL/3AS	0.481	62
2 200	2 900	NATV35/3AS	NATV35X/3AS	NATV35LL/3AS	NATV35XLL/3AS	0.647	72
2 000	2 600	NATV40/3AS	NATV40X/3AS	NATV40LL/3AS	NATV40XLL/3AS	0.890	80
1 600	2 100	NATV50/3AS	NATV50X/3AS	NATV50LL/3AS	NATV50XLL/3AS	0.990	90

2) The allowable speed of bearings with a "*" mark seal is about 10 000 min⁻¹.

Roller follower yoke type track roller
metric series

NUTR2 type
NUTR2·X type
NUTR3 type
NUTR3·X type

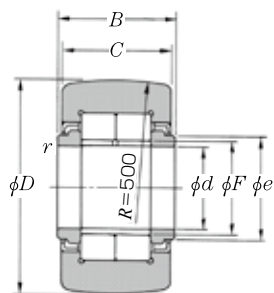

NUTR2 type
NUTR3 type

D 35 ~ 110mm

Outer dia. ¹⁾ mm D $0_{-0.05}$	Dimensions mm							Basic load rating		Track load capacity		Fatigue load limit N C_U
	d	B	C	e	F	r_s min ²⁾	dynamic C_r	static C_{0r}	Spherical outer ring N	Cylindrical outer ring N		
35	15	19 $^0_{-0.210}$	18	20	19	0.3	22 300	25 700	3 200	11 900	3 150	
40	17	21 $^0_{-0.210}$	20	22	21.5	0.3	24 100	29 100	3 850	14 500	3 550	
42	15	19 $^0_{-0.210}$	18	20	19	0.3	22 300	25 700	4 100	14 300	3 150	
47	17	21 $^0_{-0.210}$	20	22	21.5	0.3	24 100	29 100	4 700	17 000	3 550	
	20	25 $^0_{-0.210}$	24	27	25.5	0.3	38 500	48 000	4 700	21 000	5 900	
52	20	25 $^0_{-0.210}$	24	27	25.5	0.3	38 500	48 000	5 550	23 300	5 900	
	25	25 $^0_{-0.210}$	24	31	30	0.3	42 500	57 500	5 550	23 300	7 000	
62	25	25 $^0_{-0.210}$	24	31	30	0.3	42 500	57 500	6 950	27 800	7 000	
	30	29 $^0_{-0.210}$	28	38	35	0.3	56 500	72 500	6 950	33 000	8 850	
72	30	29 $^0_{-0.210}$	28	38	35	0.3	56 500	72 500	8 050	38 500	8 850	
	35	29 $^0_{-0.210}$	28	44	41.5	0.6	62 000	85 500	8 050	37 000	10 400	
80	35	29 $^0_{-0.210}$	28	44	41.5	0.6	62 000	85 500	9 800	41 000	10 400	
	40	32 $^0_{-0.250}$	30	51	47.5	0.6	87 000	125 000	9 800	44 500	15 200	
85	45	32 $^0_{-0.250}$	30	55	52.5	0.6	92 000	137 000	10 400	47 000	16 700	
90	40	32 $^0_{-0.250}$	30	51	47.5	0.6	87 000	125 000	11 400	50 000	15 200	
	50	32 $^0_{-0.250}$	30	60	57	0.6	96 500	150 000	11 400	50 000	18 300	
100	45	32 $^0_{-0.250}$	30	55	52.5	0.6	92 000	137 000	13 000	55 500	16 700	
110	50	32 $^0_{-0.250}$	30	60	57	0.6	96 500	150 000	14 700	61 000	18 300	

1) The tolerance of outer ring outer diameter D of NUTR2·X type and NUTR3·X type having a cylindrical outer diameter surface is JIS 0 class.

2) Smallest allowable dimension for chamfer dimension r .

Allowable speed min ⁻¹ Grease lubrication	Number		Mass kg (approx.)	Outer dia. ¹⁾ mm D $0_{-0.05}$
	Spherical outer ring	Cylindrical outer ring		
5 500	NUTR202/3AS	NUTR202X/3AS	0.100	35
4 700	NUTR203/3AS	NUTR203X/3AS	0.147	40
5 500	NUTR302/3AS	NUTR302X/3AS	0.160	42
4 700	NUTR303/3AS	NUTR303X/3AS	0.222	47
4 000	NUTR204/3AS	NUTR204X/3AS	0.245	
4 000	NUTR304/3AS	NUTR304X/3AS	0.321	52
3 300	NUTR205/3AS	NUTR205X/3AS	0.281	
3 300	NUTR305/3AS	NUTR305X/3AS	0.450	62
2 900	NUTR206/3AS	NUTR206X/3AS	0.466	
2 900	NUTR306/3AS	NUTR306X/3AS	0.697	72
2 400	NUTR207/3AS	NUTR207X/3AS	0.630	
2 400	NUTR307/3AS	NUTR307X/3AS	0.840	80
2 100	NUTR208/3AS	NUTR208X/3AS	0.817	
1 900	NUTR209/3AS	NUTR209X/3AS	0.883	85
2 100	NUTR308/3AS	NUTR308X/3AS	1.13	90
1 800	NUTR210/3AS	NUTR210X/3AS	0.950	
1 900	NUTR309/3AS	NUTR309X/3AS	1.40	100
1 800	NUTR310/3AS	NUTR310X/3AS	1.69	110

Needle Roller Bearings

Roller follower yoke type track roller
metric series

NUTW2 type
NUTW·X type

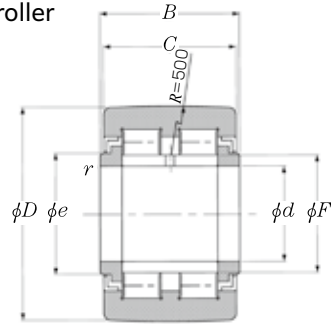

NUTW2 type

D 35 ~ 90mm

Outer dia. ¹⁾ mm D 0 -0.05	Dimensions mm							Basic load rating		Track load capacity		Fatigue load limit N C_u
	d	B	C	e	F	r_s min ²⁾	dynamic N C_r	static N C_{0r}	Spherical outer ring N	Cylindrical outer ring N		
35	15	22	0 -0.210	21	20	19	0.3	24 100	28 300	3 200	14 200	3 450
40	17	24	0 -0.210	23	22	21.5	0.3	26 000	32 000	3 850	17 100	3 900
47	20	29	0 -0.210	28	27	25.5	0.3	40 500	51 500	4 700	25 100	6 300
52	25	29	0 -0.210	28	31	30	0.3	45 000	61 500	5 550	27 700	7 500
62	30	35	0 -0.210	34	38	35	0.3	59 500	77 000	6 950	41 000	9 400
72	35	35	0 -0.210	34	44	41.5	0.6	65 000	91 000	8 050	46 000	11 100
80	40	38	0 -0.250	36	51	47.5	0.6	90 500	131 000	9 800	54 500	16 000
85	45	38	0 -0.250	36	55	52.5	0.6	95 500	144 000	10 400	58 000	17 600
90	50	38	0 -0.250	36	60	57	0.6	100 000	158 000	11 400	61 500	19 200

Needle Roller Bearings

Allowable speed min ⁻¹ Grease lubrication	Number		Mass kg (approx.)	Outer dia. ¹⁾ mm D 0 -0.05
	Spherical outer ring	Cylindrical outer ring		
5 500	NUTW202/3AS	NUTW202X/3AS	0.115	35
4 700	NUTW203/3AS	NUTW203X/3AS	0.167	40
4 000	NUTW204/3AS	NUTW204X/3AS	0.280	47
3 300	NUTW205/3AS	NUTW205X/3AS	0.322	52
2 900	NUTW206/3AS	NUTW206X/3AS	0.549	62
2 400	NUTW207/3AS	NUTW207X/3AS	0.747	72
2 100	NUTW208/3AS	NUTW208X/3AS	0.953	80
1 900	NUTW209/3AS	NUTW209X/3AS	1.03	85
1 800	NUTW210/3AS	NUTW210X/3AS	1.11	90

1) For bearings having a cylindrical outer ring surface, code "X" is added after the bearing number. In this case, the tolerance of outer ring outer diameter D of cylindrical bearings is JIS 0 class. Example: NUTW203X
2) Smallest allowable dimension for chamfer dimension r .

Bearing Units

Bearing Units Contents

Bearing units	F- 2
Cast iron pillow blocks	F-14
Cast iron square flanged unit	F-24
Round flange with cast iron spigot joint	F-28
Cast iron rhombus flanged unit	F-32
Cast iron take-up unit	F-36

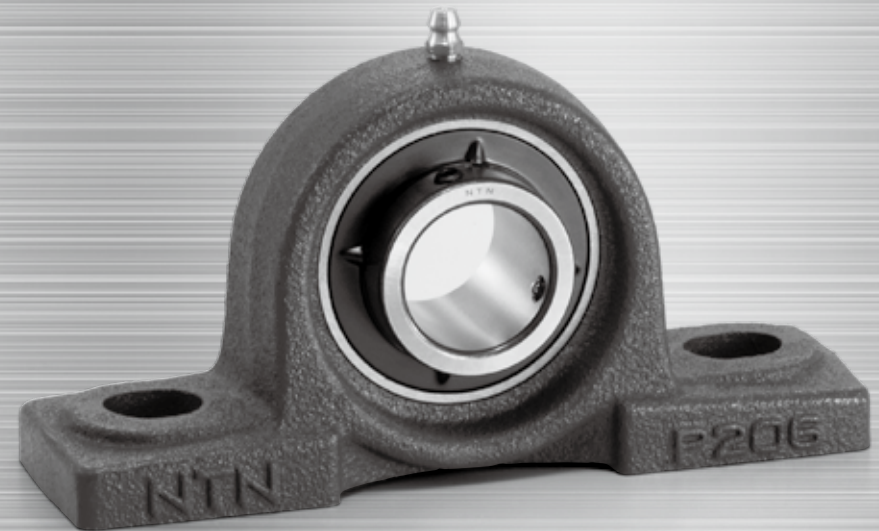

1. Design features and characteristics of bearing unit

The **NTN** bearing unit is a combination of a radial ball bearing with seals and a cast iron or steel housing of various shapes. The bearing outer diameter surface and the housing inner diameter surface are spherical and have a self-aligning design.

The internal construction of the ball bearing for units uses the same steel ball and cage as the bearing series 62 and 63 of the **NTN** deep groove ball bearings. Seals consisting of an oil resistant synthetic rubber, and a **NTN** unique slinger (also referred to as a flinger) is provided on both sides.

The included bearings for units are factory filled with grease and sealed, but can be re-lubricated from the grease fitting. See section "11. Lubrication" for greases used.

The ball bearings for units have a wide inner ring which depending on the type, fit to the shaft in the following ways:

1. The inner ring is fastened to the shaft in two places by ball point setscrews.
2. The inner ring has a tapered bore and is fitted to the shaft by means of an adapter.
3. The inner ring is fastened to the shaft by an eccentric locking collar system by means of eccentric grooves on the side of the inner ring and a collar.
4. The inner ring is fastened to the shaft by providing an interference fit.

For the details of **NTN** bearing units, see the special catalog "**Bearing units (CAT. No. 2400/E)**."

NTN bearing unit with grease fitting

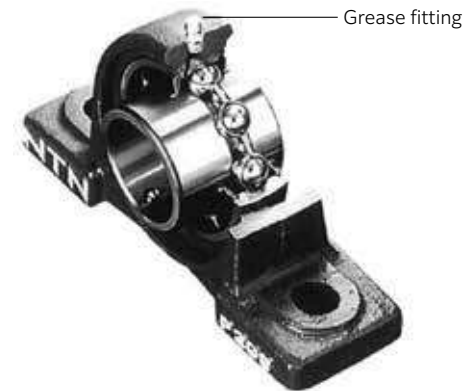

NTN bearing unit without grease fitting

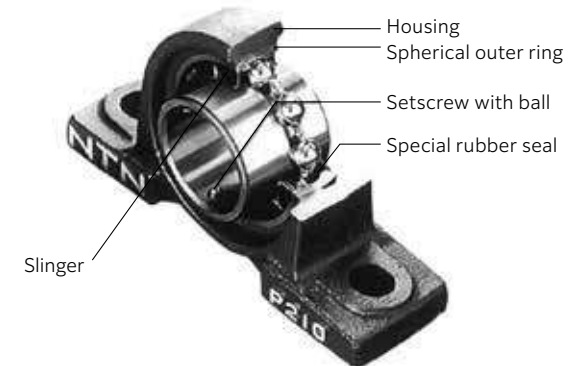

2. Bearing unit types

Table 1 Main types of ball bearings for bearing units

<p>UC (S) type Cylindrical bore type Setscrew type</p>		
	(F-)UC type	UCS type
<p>UEL (S) type Cylindrical bore type Eccentric collar type</p>		
	UEL type	UELS type
<p>AEL (S) type Cylindrical bore type Eccentric collar type</p>		
	AEL type	AELS type
<p>UK (S) type Tapered bore type Adapter type</p>		
	UK type	UKS type
<p>AS (S) type Cylindrical bore type Setscrew type</p>		
	AS type	ASS type
<p>CS type Cylindrical bore type Tight fit type</p>		
	CS...LLU type	

Table 2 (1) List of cast iron pillow bearing unit types

Housing type	Cover	Bearing type					
Cast iron pillow type	None	UCP	UEL	UKP	ASP	AELP	—
	Steel	S(M)-UCP	—	S(M)-UKP	S(M)-ASP	—	—
	Cast iron	C(M)-UCP	C(M)E-UEL	C(M)-UKP	C(M)-ASP	—	—
Cast iron thick pillow type	None	UCIP	UELIP	UKIP	—	—	—
	Steel	S(M)-UCIP	—	S(M)-UKIP	—	—	—
	Cast iron	C(M)-UCIP	C(M)E-UELIP	C(M)-UKIP	—	—	—
Cast iron center height pillow type	None	UCHP	UELHP	UKHP	ASHP	AELHP	—
	Steel	S(M)-UCHP	—	S(M)-UKHP	S(M)-ASHP	—	—
Cast iron narrow width pillow type	None	UCUP	UELUP	UKUP	ASUP	AELUP	—
	Steel	S(M)-UCUP	—	S(M)-UKUP	S(M)-ASUP	—	—
Lightweight cast iron pillow type	None	—	—	—	ASPB	AELPB	CSPB
Cast iron low center height pillow type	None	UCPL	UELPL	UKPL	ASPL	AELPL	—

Note: 1. Type code S- is given for steel covers that open on both sides, and type code SM- is given for steel covers that close on one side.
 2. Type code C- is given for cast iron covers that open on both sides, and type code CM- is given for cast iron covers that close on one side.
 However, in the case of cast iron covers combined with eccentric locking ring bearings, type code CE- is given for covers that open on both sides, and type code CME- is given for covers that close on one side.

Table 2 (2) List of cast iron flange bearing unit types

Housing type	Cover	Bearing type					
Cast iron square flange	None	UCF	UELF	UKF	ASF	AELF	—
	Steel	S(M)-UCF	—	S(M)-UKF	S(M)-ASF	—	—
	Cast iron	C(M)-UCF	C(M)E-UELF	C(M)-UKF	C(M)-ASF	—	—
Square flange with cast iron spigot joint	None	UCFS	UELFS	UKFS	—	—	—
	Cast iron	C(M)-UCFS	C(M)E-UELFS	C(M)-UKFS	—	—	—
Round flange with cast iron spigot joint	None	UCFC	UELFC	UKFC	ASFC	AELFC	—
	Steel	S(M)-UCFC	—	S(M)-UKFC	S(M)-ASFC	—	—
	Cast iron	C(M)-UCFC	C(M)E-UELFC	C(M)-UKFC	C(M)-ASFC	—	—
Cast iron rhombic flange	None	UCFL	UEFL	UKFL	ASFL	AELFL	—
	Steel	S(M)-UCFL	—	S(M)-UKFL	S(M)-ASFL	—	—
	Cast iron	C(M)-UCFL	C(M)E-UEFL	C(M)-UKFL	C(M)-ASFL	—	—
Cast iron square flange	None	UCFU	UELFU	UKFU	ASFU	AELFU	—
Cast iron rhombic flange	None	UCFLU	UEFLU	UKFLU	ASFLU	AELFLU	—
Cast iron deformed rhombic flange	None	UCFA	UELFA	UKFA	ASFA	AELFA	—
	Steel	S(M)-UCFA	—	S(M)-UKFA	S(M)-ASFA	—	—
Lightweight cast iron rhombic flange	None	—	—	—	ASFB	AELFB	CSPB
Lightweight cast iron rhombic flange	None	—	—	—	ASFD	AELFD	—
Cast iron deformed flange	None	UCFH	UELFH	UKFH	ASFH	AELFH	—

Note: 1. Type code S- is given for steel opening covers, and type code SM- is given for steel closing covers.
 2. Type code C- is given for cast iron opening covers, and type code CM- is given for cast iron closing covers.
 However, in the case of cast iron covers combined with eccentric locking ring bearings, type code CE- is given for covers that open on both sides, and type code CME- is given for covers that close on one side.
 3. The housing type of F and FU types, FL and FLU types, and FB and FD types are the same but have different attachment part dimensions.

Table 2 (3) List of other cast iron bearing unit types

Housing type	Cover	Bearing type					
		UC	UEL	UK;H	AS	AEL	CS
Cast iron take-up type	None	UCT	UFLT	UKT	AST	AELT	—
	Steel	S(M)-UCT	—	S(M)-UKT	S(M)-AST	—	—
	Cast iron	C(M)-UCT	C(M)E-UFLT	C(M)-UKT	C(M)-AST	—	—
Cast iron cartridge type	None	UCC	UELCC	UKC	ASC	AELC	—
Cast iron hanger type	None	UCHB	UELHB	UKHB	ASHB	AELHB	—

Note: 1. Type code S- is given for steel covers that open on both sides, and type code SM- is given for steel covers that close on one side.
 2. Type code C- is given for cast iron covers that open on both sides, and type code CM- is given for cast iron covers that close on one side.
 However, in the case of cast iron covers combined with eccentric locking ring bearings, type code CE- is given for covers that open on both sides, and type code CME- is given for covers that close on one side.

Table 2 (4) List of spherical graphite cast iron bearing unit types (ductile series)

Housing type	Cover	Bearing type					
		UC	UEL	UK;H	AS	AEL	CS
Spherical graphite cast iron pillow type	None	UCPE	UELPE	UKPE	ASPE	AELPE	—
Spherical graphite cast iron rhombic flange	None	UCFE	UELFE	UKFE	ASFE	AELFE	—

Table 2 (5) List of structural rolled steel bearing unit types (steel series)

Housing type	Cover	Bearing type					
		UC	UEL	UK;H	AS	AEL	CS
Structural rolled steel pillow type	None	UCPG	UELPG	UKPG	ASPG	AELPG	—
	Steel	S(M)-UCPG	—	S(M)-UKPG	S(M)-ASPG	—	—
	Cast iron	C(M)-UCPG	C(M)E-UELPG	C(M)-UKPG	C(M)-ASPG	—	—
Structural rolled steel thick pillow type	None	UCIPG	UELIPG	UKIPG	—	—	—
	Steel	S(M)-UCIPG	—	S(M)-UKIPG	—	—	—
	Cast iron	C(M)-UCIPG	C(M)E-UELIPG	C(M)-UKIPG	—	—	—
Structural rolled steel square flange	None	UCFG	UEFLG	UKFG	ASFG	AELFG	—
	Steel	S(M)-UCFG	—	S(M)-UKFG	S(M)-ASFG	—	—
	Cast iron	C(M)-UCFG	C(M)E-UEFLG	C(M)-UKFG	C(M)-ASFG	—	—
Structural rolled steel square flange with spigot joint	None	UCFSG	UEFLSG	UKFSG	—	—	—
	Cast iron	C(M)-UCFSG	C(M)E-UEFLSG	C(M)-UKFSG	—	—	—
	Steel	S(M)-UCFCG	—	S(M)-UKFCG	S(M)-ASFCG	—	—
Structural rolled steel round flange with spigot joint	None	UCFLG	UEFLG	UKFLG	ASFLG	AELFLG	—
	Steel	S(M)-UCFLG	—	S(M)-UKFLG	S(M)-ASFLG	—	—
	Cast iron	C(M)-UCFLG	C(M)E-UEFLG	C(M)-UKFLG	C(M)-ASFLG	—	—
Structural rolled steel rhombic flange	None	UCTG	UFLTG	UKTG	ASTG	AELTG	—
	Steel	S(M)-UCTG	—	S(M)-UKTG	S(M)-ASTG	—	—
	Cast iron	C(M)-UCTG	C(M)E-UFLTG	C(M)-UKTG	C(M)-ASTG	—	—

Note: 1. Type code S- is given for steel covers that open on both sides, and type code SM- is given for steel covers that close on one side.
 2. Type code C- is given for cast iron covers that open on both sides, and type code CM- is given for cast iron covers that close on one side.
 However, in the case of cast iron covers combined with eccentric locking ring bearings, type code CE- is given for covers that open on both sides, and type code CME- is given for covers that close on one side.

Table 2 (6) List of stainless steel bearing unit types (stainless steel series)

Housing type	Cover	Bearing type					
		UC	UEL	UK;H	AS	AEL	CS
Cast iron take-up type	None	F-UCPM	—	—	—	—	—
	Stainless steel	F-FS(M)-UCPM	—	—	—	—	—
Stainless steel cast iron square flange	None	F-UCQFM	—	—	—	—	—
	Stainless steel	F-FS(M)-UCQFM	—	—	—	—	—
Stainless steel cast iron rhombic flange	None	F-UCFM	—	—	—	—	—
	Stainless steel	F-FS(M)-UCFM	—	—	—	—	—

Note: Type code F- FSM- is given for stainless steel covers that close on one side.

Table 2 (7) List of glass-fiber reinforced resin bearing unit types (plastic series)

Housing type	Cover	Bearing type					
		UC	UEL	UK;H	AS	AEL	CS
Glass-fiber reinforced resin pillow type	None	F-UCPR	—	—	—	—	—
	Resin	F-RM-UCPR	—	—	—	—	—
Glass-fiber reinforced resin rhombic flange	None	F-UCFLR	—	—	—	—	—
	Resin	F-RM-UCFLR	—	—	—	—	—

Note: The resin cover is only on one side.

Table 2 (8) List of steel bearing unit types

Housing type	Cover	Bearing type					
		UC	UEL	UK;H	AS	AEL	CS
Steel pillow type	None	—	—	—	ASPP	AELPP	CSPP
Steel pillow type with rubber ring	None	—	—	—	ASRPP	AELRPP	CSRPP
Steel round flange type	None	—	—	—	ASPF	AELPF	CSPF
Steel round flange type with rubber ring	None	—	—	—	ASRPF	AELRPF	CSRPF
Steel rhombic flange	None	—	—	—	ASPFL	AELPFL	CSPFL
Steel rhombic flange type with rubber ring	None	—	—	—	ASRPFL	AELRPFL	CSRPF

Table 2 (9) List of stretcher® unit types

Housing type	Cover	Bearing type				
		UC	UEL	UK;H	AS	AEL
Stretcher steel mini type	None	—	—	—	ASPT	AELPT
Stretcher protrusion steel frame	None	UCT-00	UFLT-00	UKT-00	AST-00	AELT-00
	Steel	S(M)-UCT-00	—	S(M)-UKT-00	S(M)-AST-00	—
	Cast iron	C(M)-UCT-00	C(M)E-UFLT-00	C(M)-UKT-00	C(M)-AST-00	—
Stretcher light groove steel frame	None	UCL-00	UELL-00	UKL-00	ASL-00	AELL-00
	Steel	S(M)-UCL-00	—	S(M)-UKL-00	S(M)-ASL-00	—
	Cast iron	C(M)-UCL-00	C(M)E-UELL-00	C(M)-UKL-00	C(M)-ASL-00	—
Stretcher groove steel frame	None	UCM-00	UELM-00	UKM-00	ASM-00	AELM-00
	Steel	S(M)-UCM-00	—	S(M)-UKM-00	S(M)-ASM-00	—
	Cast iron	C(M)-UCM-00	C(M)E-UELM-00	C(M)-UKM-00	C(M)-ASM-00	—

Note: 1. Type code S- is given for steel covers that open on both sides, and type code SM- is given for steel covers that close on one side.
 2. Type code C- is given for cast iron covers that open on both sides, and type code CM- is given for cast iron covers that close on one side.
 However, in the case of cast iron covers combined with eccentric locking ring bearings, type code CE- is given for covers that open on both sides, and type code CME- is given for covers that close on one side.

3. Accuracy

The accuracy of NTN bearing units conform to JIS B1558 (Roller bearings: insert bearings and eccentric locking rings) and JIS B1559 (Roller bearings: insert bearings and steel housings).

3.1 Accuracy of ball bearings for units

Tables 3 and 4 show the accuracy of ball bearings for units.

Table 3 Tolerance values for inner rings

Unit: μm

Nominal bearing bore diameter d mm		Cylindrical bore bearings										
		Bearing bore diameter						Dimensional tolerance of eccentricity amount of eccentric surface of eccentric collar type bearings ΔH_s		Dimensional tolerance of inner ring width ΔB_s (approx.)		Radial runout K_{1a} (approx.) Max.
		All models except CS type				CS type						
Over	Incl.	Mean bore diameter deviation Δ_{dmp}		Bore diameter variation V_{dsp} Max.		Mean bore diameter deviation Δ_{dmp}		Upper	Lower	Upper	Lower	
10	18	+15	0	10	0	-8	+100	-100	0	-120	15	
18 ¹⁾	31.75	+18	0	12	0	-10	+100	-100	0	-120	18	
31.75	50.8	+21	0	14	0	-12	+100	-100	0	-120	20	
50.8	80	+24	0	16	0	-15	+100	-100	0	-150	25	
80	120	+28	0	19	0	-20	+100	-100	0	-200	30	
120	180	+33	0	22	0	-25	+100	-100	0	-250	35	

1) 10 mm is included in this dimensional division.

2) See the section of "6. Bearing tolerance" for the tolerance and tolerance values for tapered bores.

Table 4 Tolerance values for outer rings

Unit: μm

Nominal bearing outer diameter D mm		Mean outside diameter deviation $\Delta_{Dm}^{1)}$		Radial runout K_{ea} (approx.) Max.
Over	Incl.	Upper	Lower	
30	50	0	-11	20
50	80	0	-13	25
80	120	0	-15	35
120	150	0	-18	40
150	180	0	-25	45
180	250	0	-30	50
250	315	0	-35	60

1) The lower value of the dimensional tolerance of the average outer diameter specified in the table does not apply to the distance of 1/4 of the width dimension of the outer ring side surface to the outer ring.

3.2 Accuracy of housings for units

Table 5 shows the spherical bearing seating (spherical surface inner diameter) of housings for units. For other dimensional accuracy, see the special catalog "Bearing units (CAT. No. 2400/E)."

Table 5 Dimensional tolerance of inner diameter of cast iron housings

Unit: μm

Nominal bore diameter of spherical bearing seating D_a (mm)		Dimensional tolerance of average inner diameter within the plane of spherical bearing seating Δ_{Dam}					
		Tolerance class H7		Tolerance class J7		Tolerance class K7	
		Upper	Lower	Upper	Lower	Upper	Lower
30	50	+25	0	+14	-11	+7	-18
50	80	+30	0	+18	-12	+9	-21
80	120	+35	0	+22	-13	—	—
120	180	+40	0	+26	-14	—	—
180	250	+46	0	+30	-16	—	—
250	315	+52	0	+36	-16	—	—

Spherical bearing seatings with an inner diameter of 52 mm or below is finished in the tolerance class K7, 53 mm to 180 mm is finished in the tolerance class J7, and 181 mm or above is finished in the tolerance class H7.

The casting indication of "J" is being abolished since 2000.

4. Allowable speed

3.3 Bearing internal clearance

The standard internal clearance of ball bearings used in bearing units is CN (see Technical Explanation 8 Table 8.8). However, for the values of CN clearance of tapered bore type bearings, the values of C3 clearance of deep groove ball bearings is applied.

The allowable speed of bearings for units that allows safe long operation is restricted by the bearing dimensions, loads, and circumferential speed of the seal contact lip. Fig. 1 shows the allowable speed that considers these factors. When higher speed is necessary, use a bearing unit that uses a non-contact type shield. Consult with NTN Engineering for additional details.

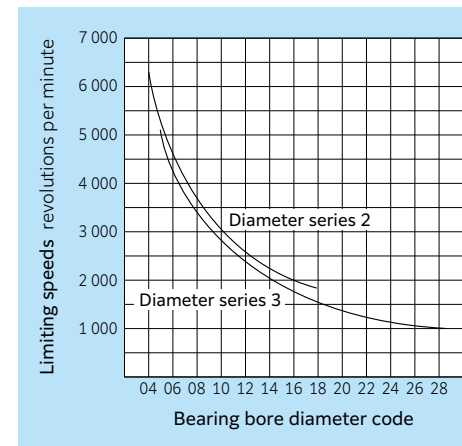

Fig. 1 Allowable speed of ball bearings for units

5. Lubrication

NTN bearing units are factory filled with an appropriate amount of grease.

The grease amount necessary for lubrication is very small in general, and the grease amount of NTN bearing units is about 1/2 to 1/3 of the bearing internal free space.

The grease must be filled until a small amount of grease is discharged to the entire circumference between the bearing outer ring inner diameter and the slinger outer diameter.

Rough standard of the amount of pressure required to insert grease: 1 to 3 MPa

6. Housing strength

The static breaking strength of housings for units differs depending on the housing type and load characteristics. The pillow block type unit is originally designed based on the use of a downward load. For other types of loading, please consult NTN Engineering.

Table 6 and Figs. 2 and 3 show approximate values of average static breaking loads by the load direction of pillow unit housings. Consult NTN Engineering for the strength of other types of housings.

The allowable load of unit housings can be obtained from the static breaking load and the safety factor S_0 shown in Table 7 from the formula below.

$$P_0 = \frac{P_{st}}{S_0}$$

P_0 : Allowable load of housing, N

P_{st} : Static breaking strength of housing, N

S_0 : Safety factor

Table 6 Static breaking load of pillow type housing

Number	Downward load kN	Number	Downward load kN
P203	75	P305	160
P204	80	P306	180
P205	95	P307	200
P206	130	P308	220
P207	160	P309	270
P208	170	P310	340
P209	180	P311	360
P210	200	P312	320
P211	210	P313	370
P212	280	P314	400
P213	290	P315	430
P214	320	P316	490
P215	330	P317	500
P216	360	P318	550
P217	450	P319	600
P218	480	P320	700
PE203	90	P321	700
PE204	100	P322	830
PE205	118	P324	900
PE206	137	P326	1 150
PE207	160	P328	1 200
PE208	186		
PE209	215		
PE210	255		
PE211	350		
PE212	400		

Table 7 Safety factor of housing

Material		Static load	Repeated load		Impact load
			Pulsating	Alternating	
SS400	Structural steel	3	5	8	12
FC200	Gray cast iron	4	6	10	15
FCD450	Ductile cast iron	4	6	10	15

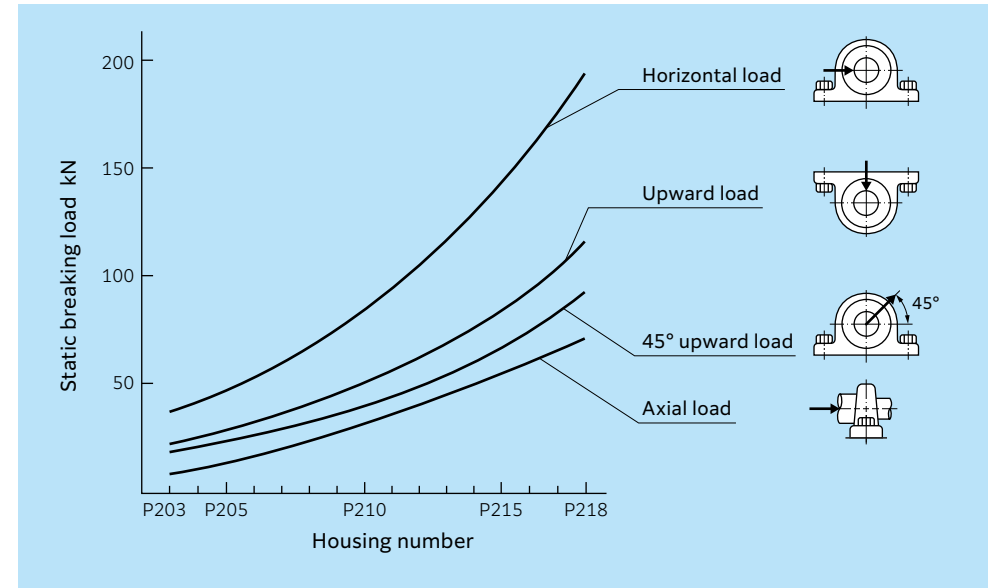

Fig. 2 Static breaking load of P2 type

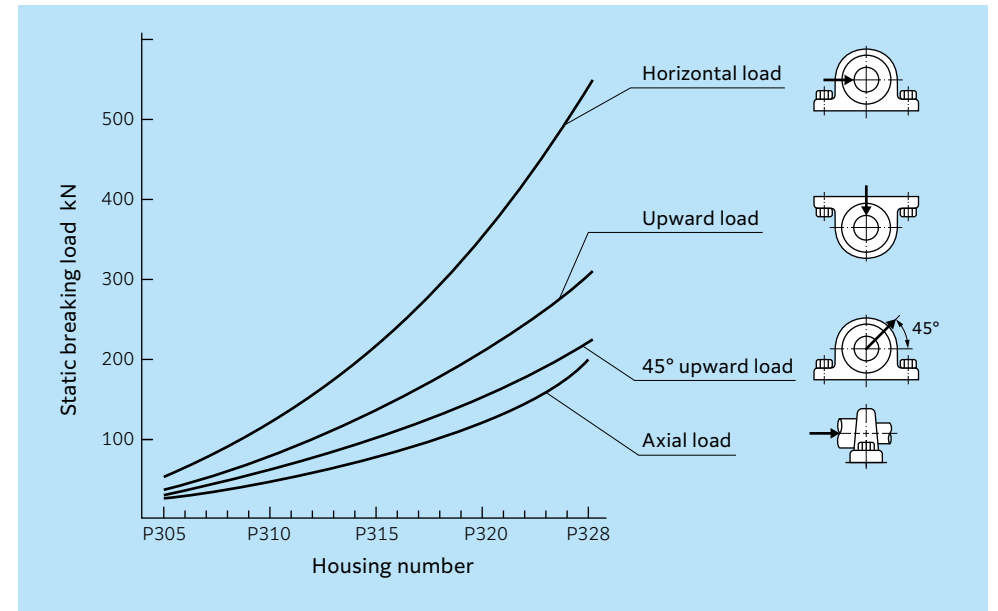

Fig. 3 Static breaking load of P3 type

7. Alignment allowance

The alignment allowance between the housing attachment surface and the shaft must be within 1/30 (1/60 for the narrow width outer ring type) due to grease channel alignment considerations. The alignment allowance of units with a cover differs depending on the cover seal, so please consult NTN Engineering.

8. Recommended bearing fits

Shafts used for NTN bearing units are not required to be highly precise, but it is desirable that the shaft is not bent or damaged.

When a bearing unit of a set screw type is to be used under a general use condition, the fitting between the inner ring and the shaft normally should be a loose fit for the assembly convenience. The appropriate values of the dimensional tolerance of the shaft are shown in Fig. 4.

In the case of the adapter sleeve type, since the shaft is fastened with a sleeve, the dimensional tolerance of the shaft can be h9 under a general use condition.

As with the set screw type, for the eccentric collar type under a general use condition, a loose fit is generally used for the fitting between the inner ring and the shaft for the assembly convenience. For the dimensional tolerance of the shaft, values indicated in Fig. 5 are appropriate.

According to the use condition, when a tight fit is to be adopted, proper installation methods shall be used and the inner ring side face shall not be struck directly to facilitate installation.

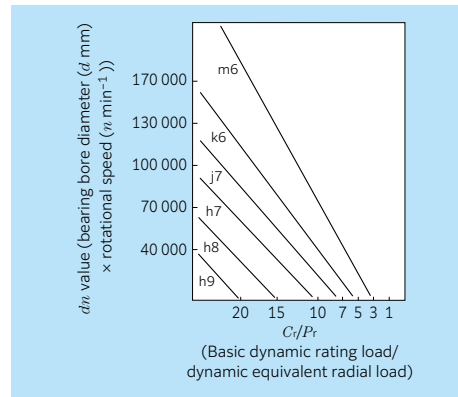

Fig. 4 Dimensional tolerance of setscrew type shaft

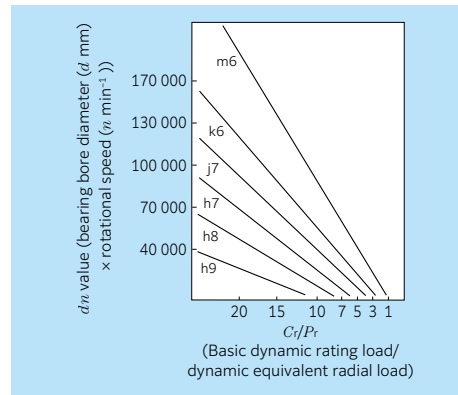

Fig. 5 Dimensional tolerance of eccentric collar type shaft

9. Recommended torque of setscrew

When bearing units of the set screw type or an eccentric collar type are to be attached to a shaft, the fastening torque shown in Tables 8 and 9 is used as a rough standard. For fastening, the two setscrews are alternately and uniformly fastened. For the details of unit attachment, see the special catalog "Bearing units (CAT. No. 2400/E)."

Table 8 Recommended fastening torque of setscrews

Applied unit bearing number			Setscrew nominal dimension		Recommended setscrew fastening torque N·m
			Inner diameter milli series	Inner diameter inch series	
AS201~203	—	—	MSS5	S8W4.826×32×7	3.4
UC201~205 AS204~205	—	—	MSS5	S8W4.826×32×7	3.9
UC206 AS206	—	UC305~306	MSS6	S8W1/4×28×8	4.9
UC207 AS207	UCX05	—	MSS6	S8W1/4×28×8	5.8
UC208~210 AS208~210	—	—	MSS8	S8W5/16×24×10	7.8
UC211	UCX06~X08	UC307	MSS8	S8W5/16×24×10	9.8
UC212	UCX09	—	MSS10	S8W3/8×24×12	16.6
UC213~215	—	UC308~309	MSS10	S8W3/8×24×12	19.6
UC216	UCX10	—	MSS10	S8W3/8×24×12	22.5
—	UCX11~X12	—	MSS10	S8W3/8×24×12	24.5
UC217~218	UCX13~X15	UC310~314	MSS12	S8W1/2×20×13	29.4
—	UCX16~X17	—	MSS12	S8W1/2×20×13	34.3
—	UCX18	UC315~316	MSS14	S8W9/16×18×15	34.3
—	UCX20	UC317~319	MSS16	S8W5/8×18×18	53.9
—	—	UC320~324	MSS18	S8W3/4×16×25	58.8
—	—	UC326~328	MSS20	—	78.4

Note: Fastening setscrews excessively may cause inner ring cracks. Loose fastening may cause the shaft to slide.

Table 9 Recommended fastening torque of eccentric collar setscrews

Applied unit bearing number		Setscrew nominal dimension		Recommended setscrew fastening torque N·m
		Inner diameter milli series	Inner diameter inch series	
UEL204~205 AEL201~205	—	MSS6	S8W1/4×28×8	7.8
UEL206 AEL206	UEL305~307	MSS8	S8W5/16×24×10	9.8
UEL207 AEL207	—	MSS10	S8W3/8×24×12	11.7
UEL208~210 AEL208~210	—	MSS10	S8W3/8×24×12	15.6
UEL211 AEL211	—	MSS10	S8W3/8×24×12	19.6
UEL212~215 AEL212	UEL308~312	MSS10	S8W3/8×24×12	29.4
—	UEL313~314	MSS12	S8W1/2×20×13	34.3
—	UEL315~317	MSS16	S8W5/8×18×18	53.9
—	UEL318~322	MSS20	S8W3/4×16×25	78.4

Cast iron pillow blocks UCP type / cylindrical bore type, setscrew type

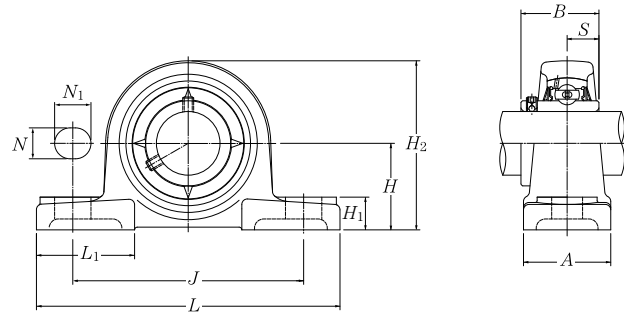

Shaft diameter: 12 to 50 mm

Shaft dia. mm	Unit number ¹⁾²⁾	Dimensions mm											Fixing bolt	Number	Bearing		
		H	L	J	A	N	N ₁	H ₁	H ₂	L ₁	B	S			C _r	Basic load rating dynamic kN C _{0r}	static kN C _{0s}
12	UCP201	30.2	127	95	38	13	16	14	62	42	31	12.7	M10	UC201D1	14.2	6.65	0.505
15	UCP202	30.2	127	95	38	13	16	14	62	42	31	12.7	M10	UC202D1	14.2	6.65	0.505
17	UCP203	30.2	127	95	38	13	16	14	62	42	31	12.7	M10	UC203D1	14.2	6.65	0.505
20	UCP204	33.3	127	95	38	13	16	14	65	42	31	12.7	M10	UC204D1	14.2	6.65	0.505
25	UCP205	36.5	140	105	38	13	16	15	71	42	34.1	14.3	M10	UC205D1	15.5	7.85	0.55
	UCPX05	44.4	159	119	51	17	20	18	85	50	38.1	15.9	M14	UCX05D1	21.6	11.3	0.795
	UCP305	45	175	132	45	17	20	15	85	54	38	15	M14	UC305D1	23.5	10.9	0.855
30	UCP206	42.9	165	121	48	17	20	17	83	54	38.1	15.9	M14	UC206D1	21.6	11.3	0.795
	UCPX06	47.6	175	127	57	17	20	20	93	54	42.9	17.5	M14	UCX06D1	28.4	15.3	1.09
	UCP306	50	180	140	50	17	20	18	95	54	43	17	M14	UC306D1	29.5	15.0	1.14
35	UCP207	47.6	167	127	48	17	20	18	93	54	42.9	17.5	M14	UC207D1	28.4	15.3	1.09
	UCPX07	54	203	144	57	17	20	21	105	60	49.2	19	M14	UCX07D1	32.5	17.8	1.24
	UCP307	56	210	160	56	17	25	20	106	60	48	19	M14	UC307D1	37.0	19.1	1.47
40	UCP208	49.2	184	137	54	17	20	18	98	52	49.2	19	M14	UC208D1	32.5	17.8	1.24
	UCPX08	58.7	222	156	67	20	23	26	111	65	49.2	19	M16	UCX08D1	36.0	20.4	1.60
	UCP308	60	220	170	60	17	27	22	116	60	52	19	M14	UC308D1	45.0	24.0	1.83
45	UCP209	54	190	146	54	17	20	20	106	60	49.2	19	M14	UC209D1	36.0	20.4	1.60
	UCPX09	58.7	222	156	67	20	23	26	116	65	51.6	19	M16	UCX09D1	39.0	23.2	1.82
	UCP309	67	245	190	67	20	30	24	129	65	57	22	M16	UC309D1	58.5	32.0	2.50
50	UCP210	57.2	206	159	60	20	23	21	114	65	51.6	19	M16	UC210D1	39.0	23.2	1.82
	UCPX10	63.5	241	171	73	20	23	27	126	70	55.6	22.2	M16	UCX10D1	48.0	29.2	2.29
	UCP310	75	275	212	75	20	35	27	143	75	61	22	M16	UC310D1	68.5	38.5	2.99

1) Spherical graphite cast iron bearings are also available based on request. In this case, a supplementary suffix "N1" is added after the unit number. Example: UCP320N1
2) The unit numbers indicate the oil-free type, and supplementary suffix "D1" is added after the number for the oil feeding type.

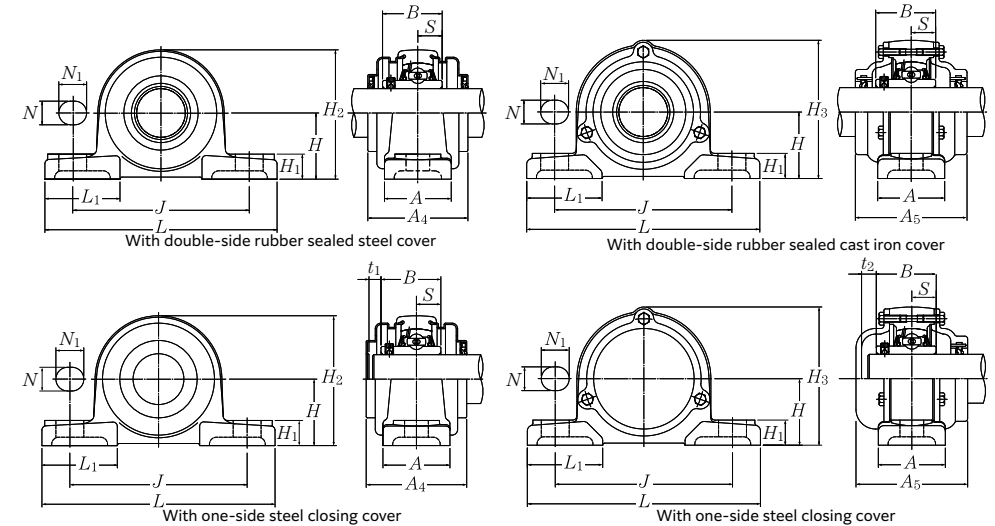

Standard housing number	Number of unit with steel cover		Number of unit with cast iron cover		Dimensions mm					Unit mass (approx.)		
	Double-side rubber sealed cover	One-side closing cover	Double-side rubber sealed cover	One-side closing cover	t ₁	t ₂	A ₄	H ₃	A ₅	Standard	kg With steel cover	kg With cast iron cover
P203	S-UCP201	SM-UCP201	C-UCP201	CM-UCP201	5	8	51	67	62	0.7	0.7	0.9
P203	S-UCP202	SM-UCP202	C-UCP202	CM-UCP202	5	8	51	67	62	0.7	0.7	0.9
P203	S-UCP203	SM-UCP203	C-UCP203	CM-UCP203	5	8	51	67	62	0.7	0.7	0.9
P204	S-UCP204	SM-UCP204	C-UCP204	CM-UCP204	5	8	51	70	62	0.7	0.7	0.9
P205	S-UCP205	SM-UCP205	C-UCP205	CM-UCP205	7	11	57	76	70	0.8	0.9	1.1
	PX05	S-UCPX05	SM-UCPX05	C-UCPX05	CM-UCPX05	7	11	62	89	75	1.4	1.5
P305	-	-	C-UCP305	CM-UCP305	-	12	-	91	80	1.4	-	1.8
P206	S-UCP206	SM-UCP206	C-UCP206	CM-UCP206	7	11	62	88	75	1.4	1.4	1.7
	PX06	S-UCPX06	SM-UCPX06	C-UCPX06	CM-UCPX06	8	10	72	99	80	1.8	2
P306	-	-	C-UCP306	CM-UCP306	-	11	-	105	85	1.8	-	2.5
P207	S-UCP207	SM-UCP207	C-UCP207	CM-UCP207	8	10	72	99	80	1.6	1.7	2
	PX07	S-UCPX07	SM-UCPX07	C-UCPX07	CM-UCPX07	8	9	82	110	90	2.4	2.6
P307	-	-	C-UCP307	CM-UCP307	-	13	-	115	95	2.5	-	3.2
P208	S-UCP208	SM-UCP208	C-UCP208	CM-UCP208	8	9	82	105	90	1.9	2.1	2.7
	PX08	S-UCPX08	SM-UCPX08	C-UCPX08	CM-UCPX08	8	12	82	118	95	2.9	3.1
P308	-	-	C-UCP308	CM-UCP308	-	13	-	125	105	3	-	4.1
P209	S-UCP209	SM-UCP209	C-UCP209	CM-UCP209	8	12	82	113	95	2.2	2.4	3
	PX09	S-UCPX09	SM-UCPX09	C-UCPX09	CM-UCPX09	8	12	87	120	100	3.2	3.5
P309	-	-	C-UCP309	CM-UCP309	-	14	-	140	110	4.1	-	5.5
P210	S-UCP210	SM-UCP210	C-UCP210	CM-UCP210	8	12	87	119	100	2.7	2.8	3.6
	PX10	S-UCPX10	SM-UCPX10	C-UCPX10	CM-UCPX10	10	11	92	130	100	4.1	4.5
P310	-	-	C-UCP310	CM-UCP310	-	15	-	156	120	5.6	-	7.1

Cast iron pillow blocks UCP type / cylindrical bore type, setscrew type

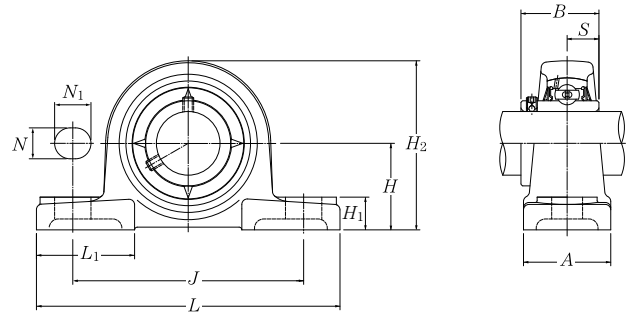

Shaft diameter: 55 to 90 mm

Shaft dia. mm	Unit number ¹⁾²⁾	Dimensions mm											Fixing bolt	Number	Bearing		
		H	L	J	A	N	N ₁	H ₁	H ₂	L ₁	B	S			Basic load rating dynamic C _r	static C _{0r}	Fatigue load limit C _u
55	UCP211	63.5	219	171	60	20	23	23	126	65	55.6	22.2	M16	UC211D1	48.0	29.2	2.29
	UCPX11	69.8	260	184	79	25	28	30	137	75	65.1	25.4	M20	UCX11D1	58.0	36.0	2.83
	UCP311	80	310	236	80	20	38	30	154	85	66	25	M16	UC311D1	79.5	45.0	3.50
60	UCP212	69.8	241	184	70	20	23	25	138	70	65.1	25.4	M16	UC212D1	58.0	36.0	2.83
	UCPX12	76.2	286	203	83	25	28	33	151	80	65.1	25.4	M20	UCX12D1	63.5	40.0	3.15
	UCP312	85	330	250	85	25	38	32	165	95	71	26	M20	UC312D1	90.5	52.0	4.10
65	UCP213	76.2	265	203	70	25	28	27	151	77	65.1	25.4	M20	UC213D1	63.5	40.0	3.15
	UCPX13	76.2	286	203	83	25	28	33	154	80	74.6	30.2	M20	UCX13D1	69.0	44.0	3.45
	UCP313	90	340	260	90	25	38	33	176	105	75	30	M20	UC313D1	103	60.0	4.60
70	UCP214	79.4	266	210	72	25	28	27	157	77	74.6	30.2	M20	UC214D1	69.0	44.0	3.45
	UCPX14	88.9	330	229	89	27	30	35	170	95	77.8	33.3	M22	UCX14D1	73.5	49.5	3.80
	UCP314	95	360	280	90	27	40	35	187	105	78	33	M22	UC314D1	115	68.0	5.10
75	UCP215	82.6	275	217	74	25	28	28	163	80	77.8	33.3	M20	UC215D1	73.5	49.5	3.80
	UCPX15	88.9	330	229	89	27	30	35	175	95	82.6	33.3	M22	UCX15D1	80.5	53.0	3.95
	UCP315	100	380	290	100	27	40	35	198	110	82	32	M22	UC315D1	126	77.0	5.55
80	UCP216	88.9	292	232	78	25	28	30	175	85	82.6	33.3	M20	UC216D1	80.5	53.0	3.95
	UCPX16	101.6	381	283	102	27	30	40	194	110	85.7	34.1	M22	UCX16D1	92.0	64.0	4.60
	UCP316	106	400	300	110	27	40	40	210	110	86	34	M22	UC316D1	136	86.5	6.05
85	UCP217	95.2	310	247	83	25	28	32	187	85	85.7	34.1	M20	UC217D1	92.0	64.0	4.60
	UCPX17	101.6	381	283	102	27	30	40	200	110	96	39.7	M22	UCX17D1	106	71.5	5.00
	UCP317	112	420	320	110	33	45	40	220	120	96	40	M27	UC317D1	147	97.0	6.55
90	UCP218	101.6	327	262	88	27	30	33	200	90	96	39.7	M22	UC218D1	106	71.5	5.00
	UCPX18	101.6	381	283	111	27	30	40	206	110	104	42.9	M22	UCX18D1	121	82.0	5.55
	UCP318	118	430	330	110	33	45	45	235	120	96	40	M27	UC318D1	158	107	7.10

1) Spherical graphite cast iron bearings are also available based on request. In this case, a supplementary suffix "N1" is added after the unit number. Example: UCP320N1
 2) The unit numbers indicate the oil-free type, and supplementary suffix "D1" is added after the number for the oil feeding type.

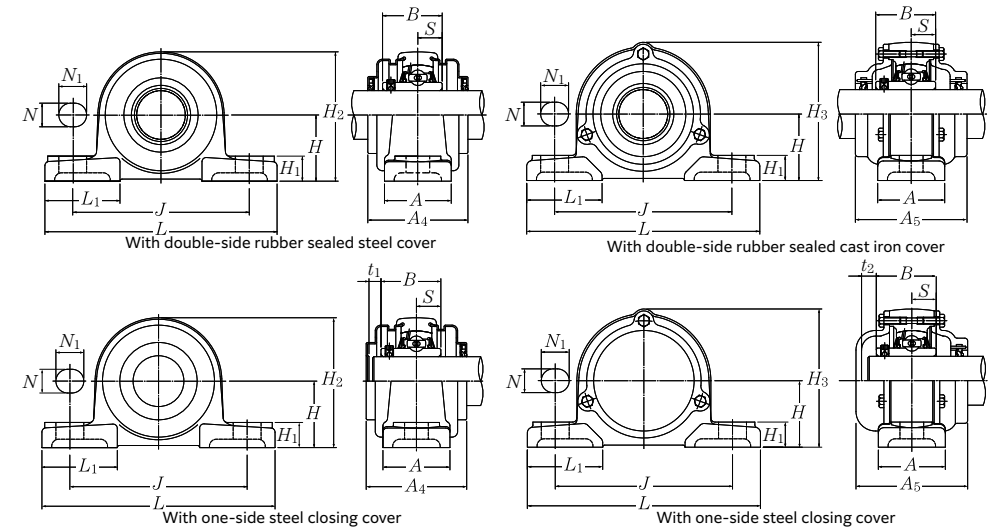

Standard housing number	Number of unit with steel cover		Number of unit with cast iron cover		Dimensions mm					Unit mass (approx.)		
	Double-side rubber sealed cover	One-side closing cover	Double-side rubber sealed cover	One-side closing cover	t ₁	t ₂	A ₄	H ₃	A ₅	Standard	kg With steel cover	With cast iron cover
P211	S-UCP211	SM-UCP211	C-UCP211	CM-UCP211	10	11	92	130	100	3.4	3.6	4.4
PX11	S-UCPX11	SM-UCPX11	C-UCPX11	CM-UCPX11	8	12	102	144	115	5.4	5.8	6.9
P311	-	-	C-UCP311	CM-UCP311	-	15	-	166	125	7.3	-	8.9
P212	S-UCP212	SM-UCP212	C-UCP212	CM-UCP212	8	12	102	143	115	4.7	5	6
PX12	S-UCPX12	SM-UCPX12	C-UCPX12	CM-UCPX12	11	15	107	155	120	6.8	7.3	8.6
P312	-	-	C-UCP312	CM-UCP312	-	16	-	179	135	9.4	-	11
P213	S-UCP213	SM-UCP213	C-UCP213	CM-UCP213	11	15	107	155	120	5.6	5.8	7.2
PX13	-	-	C-UCPX13	CM-UCPX13	-	17	-	159	135	7.1	-	9.4
P313	-	-	C-UCP313	CM-UCP313	-	19	-	190	140	10	-	13
P214	-	-	C-UCP214	CM-UCP214	-	17	-	162	135	6.5	-	8.4
PX14	-	-	C-UCPX14	CM-UCPX14	-	17	-	175	135	9.3	-	12
P314	-	-	C-UCP314	CM-UCP314	-	19	-	200	140	12	-	14
P215	-	-	C-UCP215	CM-UCP215	-	17	-	168	135	7.2	-	9.3
PX15	-	-	C-UCPX15	CM-UCPX15	-	17	-	181	145	10	-	13
P315	-	-	C-UCP315	CM-UCP315	-	19	-	210	150	14	-	17
P216	-	-	C-UCP216	CM-UCP216	-	17	-	181	145	8.7	-	11
PX16	-	-	C-UCPX16	CM-UCPX16	-	19	-	198	155	14	-	17
P316	-	-	C-UCP316	CM-UCP316	-	18	-	221	155	17	-	21
P217	-	-	C-UCP217	CM-UCP217	-	19	-	191	155	11	-	13
PX17	-	-	C-UCPX17	CM-UCPX17	-	20	-	204	165	15	-	19
P317	-	-	C-UCP317	CM-UCP317	-	21	-	235	170	19	-	24
P218	-	-	C-UCP218	CM-UCP218	-	20	-	204	165	13	-	16
PX18	-	-	C-UCPX18	CM-UCPX18	-	22	-	208	180	16	-	21
P318	-	-	C-UCP318	CM-UCP318	-	21	-	246	170	22	-	27

Bearing Units

NTN

Cast iron pillow blocks UCP type / cylindrical bore type, setscrew type

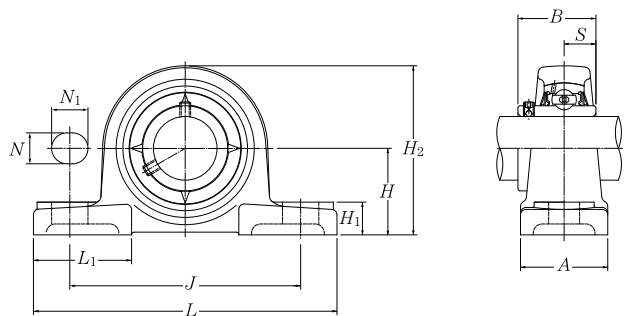

Shaft diameter: 95 to 140 mm

Shaft dia. mm	Unit number ¹⁾²⁾	Dimensions mm											Fixing bolt	Number	Bearing		
		H	L	J	A	N	N ₁	H ₁	H ₂	L ₁	B	S			C _r	C _{0r}	C _u
95	UCP319	125	470	360	120	36	50	45	250	125	103	41	M30	UC319D1	169	119	7.65
100	UCP320	140	490	380	120	36	50	50	275	130	108	42	M30	UC320D1	192	141	8.75
	UCPX20	127	432	337	121	33	36	45	244	125	117.5	49.2	M27	UCX20D1	147	105	6.75
105	UCP321	140	490	380	120	36	50	50	280	130	112	44	M30	UC321D1	204	153	9.35
110	UCP322	150	520	400	140	40	55	55	300	135	117	46	M33	UC322D1	227	179	10.5
120	UCP324	160	570	450	140	40	55	65	320	140	126	51	M33	UC324D1	229	185	10.5
130	UCP326	180	600	480	140	40	55	75	355	140	135	54	M33	UC326D1	254	214	11.7
140	UCP328	200	620	500	140	40	55	75	390	140	145	59	M33	UC328D1	280	246	13.0

Bearing Units

NTN

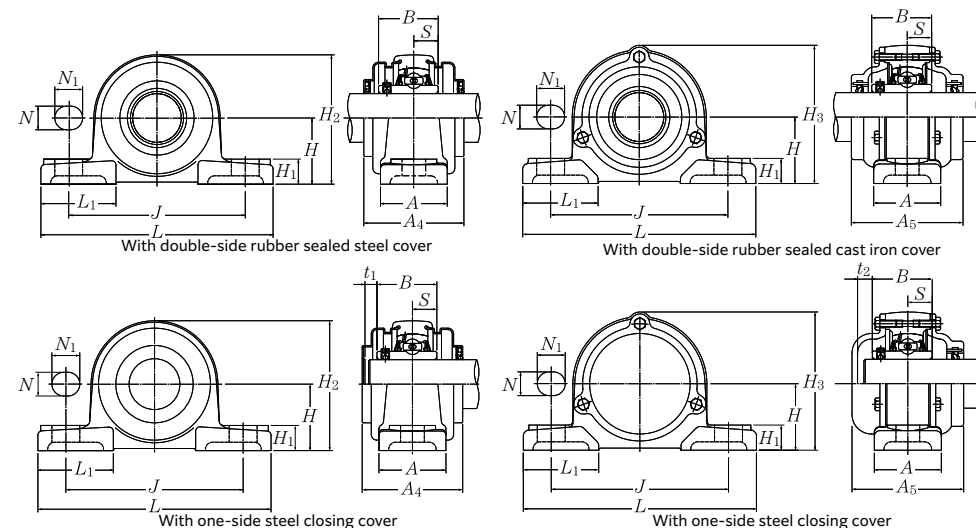

Standard housing number	Number of unit with steel cover		Number of unit with cast iron cover		Dimensions mm					Unit mass (approx.) kg		
	Double-side rubber sealed cover	One-side closing cover	Double-side rubber sealed cover	One-side closing cover	t ₁	t ₂	A ₄	H ₃	A ₅	Standard	With steel cover	With cast iron cover
P319	-	-	C-UCP319	CM-UCP319	-	20	-	258	180	26	-	32
P320	-	-	C-UCP320	CM-UCP320	-	20	-	283	190	33	-	39
PX20	-	-	C-UCPX20	CM-UCPX20	-	23	-	244	195	25	-	29
P321	-	-	C-UCP321	CM-UCP321	-	20	-	290	195	35	-	42
P322	-	-	C-UCP322	CM-UCP322	-	20	-	313	200	43	-	52
P324	-	-	C-UCP324	CM-UCP324	-	22	-	335	215	50	-	67
P326	-	-	C-UCP326	CM-UCP326	-	21	-	375	225	69	-	85
P328	-	-	C-UCP328	CM-UCP328	-	21	-	407	235	84	-	100

1) Spherical graphite cast iron bearings are also available based on request. In this case, a supplementary suffix "N1" is added after the unit number. Example: UCP320N1
 2) The unit numbers indicate the oil-free type, and supplementary suffix "D1" is added after the number for the oil feeding type.

Cast iron pillow blocks UKP type / tapered bore type, adapter type

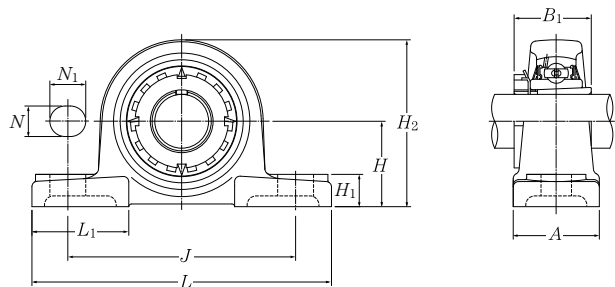

Shaft diameter: 20 to 55 mm

Shaft dia. mm	Unit number ^{1) 2) 3)}	Dimensions mm										Fixing bolt	Bearing Number	Basic load rating dynamic kN C _R	static kN C _{0r}	Fatigue load limit C _u
		H	L	J	A	N	N ₁	H ₁	H ₂	B ₁	L ₁					
		20	UKP205;H2305X UKPX05;H2305X UKP305;H2305X	36.5 44.4 45	140 159 175	105 119 132	38 51 45	13 17 17	16 20 20	15 18 15	71 85 85					
25	UKP206;H2306X UKPX06;H2306X UKP306;H2306X	42.9 47.6 50	165 175 180	121 127 140	48 57 50	17 17 17	20 20 20	17 20 18	83 93 95	38 38 38	54 54 54	M14 M14 M14	UK206D1;H2306X UKX06D1;H2306X UK306D1;H2306X	21.6 28.4 29.5	11.3 15.3 15.0	0.795 1.09 1.14
30	UKP207;H2307X UKPX07;H2307X UKP307;H2307X	47.6 54 56	167 203 210	127 144 160	48 57 56	17 17 17	20 21 20	18 105 106	93 105 106	43 43 43	54 60 60	M14 M14 M14	UK207D1;H2307X UKX07D1;H2307X UK307D1;H2307X	28.4 32.5 37.0	15.3 17.8 19.1	1.09 1.24 1.47
35	UKP208;H2308X UKPX08;H2308X UKP308;H2308X	49.2 58.7 60	184 222 220	137 156 170	54 67 60	17 20 17	20 23 27	18 26 22	98 111 116	46 46 46	52 65 60	M14 M16 M14	UK208D1;H2308X UKX08D1;H2308X UK308D1;H2308X	32.5 36.0 45.0	17.8 20.4 24.0	1.24 1.60 1.83
40	UKP209;H2309X UKPX09;H2309X UKP309;H2309X	54 58.7 67	190 222 245	146 156 190	54 67 67	17 20 20	20 23 30	20 26 24	106 116 129	50 50 50	60 65 65	M14 M16 M16	UK209D1;H2309X UKX09D1;H2309X UK309D1;H2309X	36.0 39.0 58.5	20.4 23.2 32.0	1.60 1.82 2.50
45	UKP210;H2310X UKPX10;H2310X UKP310;H2310X	57.2 63.5 75	206 241 275	159 171 212	60 73 75	20 20 20	23 27 35	21 126 143	114 126 143	55 55 55	65 70 75	M16 M16 M16	UK210D1;H2310X UKX10D1;H2310X UK310D1;H2310X	39.0 48.0 68.5	23.2 29.2 38.5	1.82 2.29 2.99
50	UKP211;H2311X UKPX11;H2311X UKP311;H2311X	63.5 69.8 80	219 260 310	171 184 236	60 79 80	20 25 20	23 30 38	23 137 154	126 137 154	59 59 59	65 75 85	M16 M20 M16	UK211D1;H2311X UKX11D1;H2311X UK311D1;H2311X	48.0 58.0 79.5	29.2 36.0 45.0	2.29 2.83 3.50
55	UKP212;H2312X UKPX12;H2312X UKP312;H2312X	69.8 76.2 85	241 286 330	184 203 250	70 83 85	20 25 25	23 28 32	25 151 165	138 151 165	62 62 62	70 80 95	M16 M20 M20	UK212D1;H2312X UKX12D1;H2312X UK312D1;H2312X	58.0 63.5 90.5	36.0 40.0 52.0	2.83 3.15 4.10

1) Spherical graphite cast iron bearings are also available based on request. In this case, a supplementary suffix "N1" is added after the unit number. Example: UKP310N1; H2310X
2) Unit numbers with the suffix "X" signify narrow slit type adapters, and use washers with straight inner tabs.

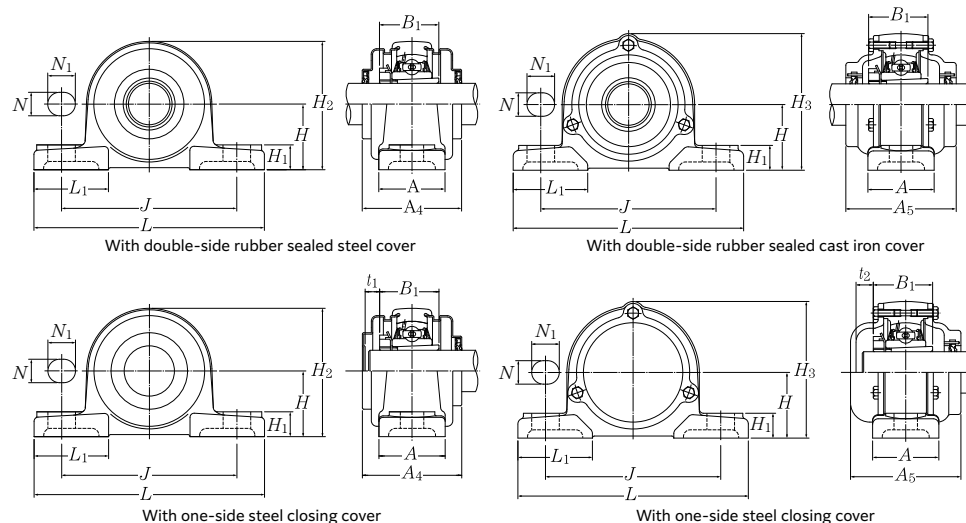

Standard housing number	Number of unit with steel cover		Number of unit with cast iron cover		Dimensions mm					Unit mass (approx.) kg		
	Double-side rubber sealed cover	One-side closing cover	Double-side rubber sealed cover	One-side closing cover	t ₁	t ₂	A ₄	H ₃	A ₅	Standard	With steel cover	With cast iron cover
PX05	-	-	C-UKPX05;H2305X	CM-UKPX05;H2305X	-	12	-	89	75	1.4	-	1.8
P305	-	-	C-UKP305;H2305X	CM-UKP305;H2305X	-	14	-	91	80	1.4	-	1.8
P206	S-UKP206;H2306X	SM-UKP206;H2306X	C-UKP206;H2306X	CM-UKP206;H2306X	8	12	62	88	75	1.4	1.4	1.8
PX06	-	-	C-UKPX06;H2306X	CM-UKPX06;H2306X	-	13	-	99	80	1.7	-	2.2
P306	-	-	C-UKP306;H2306X	CM-UKP306;H2306X	-	15	-	105	85	1.8	-	2.6
P207	S-UKP207;H2307X	SM-UKP207;H2307X	C-UKP207;H2307X	CM-UKP207;H2307X	10	12	72	99	80	1.7	1.8	2.1
PX07	-	-	C-UKPX07;H2307X	CM-UKPX07;H2307X	-	15	-	110	90	2.4	-	3.3
P307	-	-	C-UKP307;H2307X	CM-UKP307;H2307X	-	17	-	115	95	2.6	-	3.2
P208	S-UKP208;H2308X	SM-UKP208;H2308X	C-UKP208;H2308X	CM-UKP208;H2308X	13	14	82	105	90	2	2.2	2.8
PX08	-	-	C-UKPX08;H2308X	CM-UKPX08;H2308X	-	17	-	118	95	3.2	-	4.1
P308	-	-	C-UKP308;H2308X	CM-UKP308;H2308X	-	19	-	125	105	3.1	-	4.2
P209	S-UKP209;H2309X	SM-UKP209;H2309X	C-UKP209;H2309X	CM-UKP209;H2309X	12	16	82	113	95	2.3	2.5	3.2
PX09	-	-	C-UKPX09;H2309X	CM-UKPX09;H2309X	-	18	-	120	100	3.2	-	4.3
P309	-	-	C-UKP309;H2309X	CM-UKP309;H2309X	-	19	-	140	110	4.1	-	5.5
P210	S-UKP210;H2310X	SM-UKP210;H2310X	C-UKP210;H2310X	CM-UKP210;H2310X	13	17	87	119	100	2.9	3	3.8
PX10	-	-	C-UKPX10;H2310X	CM-UKPX10;H2310X	-	15	-	130	100	4.2	-	5.4
P310	-	-	C-UKP310;H2310X	CM-UKP310;H2310X	-	21	-	156	120	5.6	-	7.2
P211	S-UKP211;H2311X	SM-UKP211;H2311X	C-UKP211;H2311X	CM-UKP211;H2311X	14	15	92	130	100	3.6	3.7	4.7
PX11	-	-	C-UKPX11;H2311X	CM-UKPX11;H2311X	-	21	-	144	115	5.3	-	6.8
P311	-	-	C-UKP311;H2311X	CM-UKP311;H2311X	-	22	-	166	125	7.3	-	9
P212	S-UKP212;H2312X	SM-UKP212;H2312X	C-UKP212;H2312X	CM-UKP212;H2312X	16	20	102	143	115	4.7	5.1	6.1
PX12	-	-	C-UKPX12;H2312X	CM-UKPX12;H2312X	-	22	-	155	120	6.8	-	8.6
P312	-	-	C-UKP312;H2312X	CM-UKP312;H2312X	-	25	-	179	135	9.3	-	11

3) The unit numbers indicate the oil-free type, and supplementary suffix "D1" is added after the number for the oil feeding type.

Cast iron pillow blocks UKP type / tapered bore type, adapter type

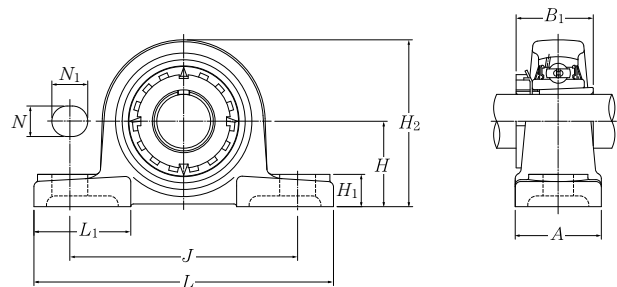

Shaft diameter: 60 to 125 mm

Shaft dia. mm	Unit number ^{1) 2) 3)}	Dimensions mm										Fixing bolt	Bearing Number	Basic load rating dynamic C _R	static kN C _{0r}	Fatigue load limit C _u
		H	L	J	A	N	N ₁	H ₁	H ₂	B ₁	L ₁					
		60	UKP213;H2313X UKPX13;H2313X UKP313;H2313X	76.2 76.2 90	265 286 340	203 203 260	70 83 90	25 25 25	28 28 38	27 33 33	151 154 176					
65	UKP215;H2315X UKPX15;H2315X UKP315;H2315X	82.6 88.9 100	275 330 380	217 229 290	74 89 100	25 27 27	28 30 35	28 35 40	163 175 198	73 73 73	80 95 110	M20 M22 M22	UK215D1;H2315X UKX15D1;H2315X UK315D1;H2315X	73.5 80.5 126	49.5 53.0 77.0	3.80 3.95 5.55
70	UKP216;H2316X UKPX16;H2316X UKP316;H2316X	88.9 101.6 106	292 381 400	232 283 300	78 102 110	25 27 27	28 30 30	30 40 40	175 194 210	78 78 78	85 110 110	M20 M22 M22	UK216D1;H2316X UKX16D1;H2316X UK316D1;H2316X	80.5 92.0 136	53.0 64.0 86.5	3.95 4.60 6.05
75	UKP217;H2317X UKPX17;H2317X UKP317;H2317X	95.2 101.6 112	310 381 420	247 283 320	83 102 110	25 27 33	28 30 45	32 40 40	187 200 220	82 82 82	85 110 120	M20 M22 M27	UK217D1;H2317X UKX17D1;H2317X UK317D1;H2317X	92.0 106 147	64.0 71.5 97.0	4.60 5.00 6.55
80	UKP218;H2318X UKPX18;H2318X UKP318;H2318X	101.6 101.6 118	327 381 430	262 283 330	88 111 110	27 27 33	30 30 45	33 40 45	200 206 235	86 86 86	90 110 120	M22 M22 M27	UK218D1;H2318X UKX18D1;H2318X UK318D1;H2318X	106 121 158	71.5 82.0 107	5.00 5.55 7.10
85	UKP319;H2319X	125	470	360	120	36	50	45	250	90	125	M30	UK319D1;H2319X	169	119	7.65
90	UKPX20;H2320X UKP320;H2320X	127 140	432 490	337 380	121 120	33 36	45 50	244 275	97 97	125 130	M27 M30	UKX20D1;H2320X UK320D1;H2320X	147 192	105 141	6.75 8.75	
100	UKP322;H2322X	150	520	400	140	40	55	55	300	105	135	M33	UK322D1;H2322X	227	179	10.5
110	UKP324;H2324X	160	570	450	140	40	55	65	320	112	140	M33	UK324D1;H2324X	229	185	10.5
115	UKP326;H2326	180	600	480	140	40	55	75	355	121	140	M33	UK326D1;H2326	254	214	11.7
125	UKP328;H2328	200	620	500	140	40	55	75	390	131	140	M33	UK328D1;H2328	280	246	13.0

1) Spherical graphite cast iron bearings are also available based on request. In this case, a supplementary suffix "N1" is added after the unit number. Example: UKP310N1; H2310X

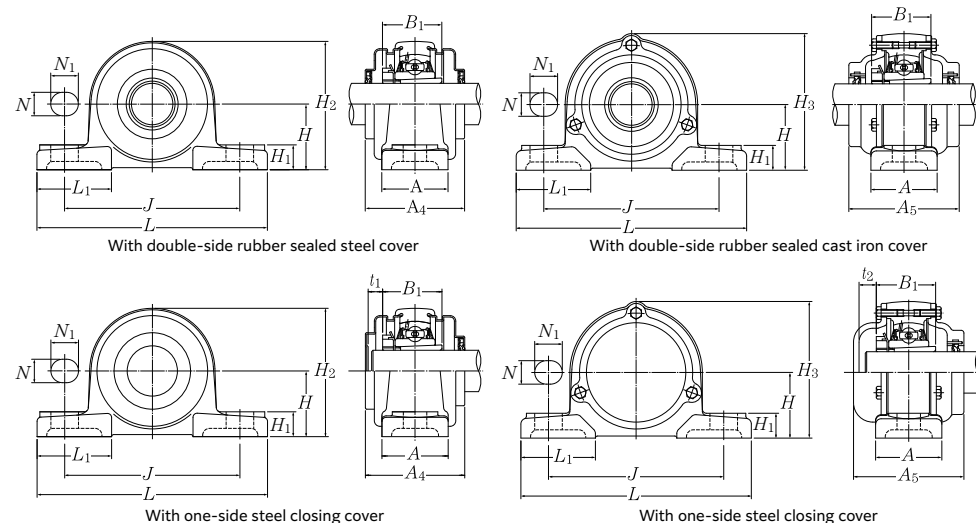

Standard housing number	Number of unit with steel cover		Number of unit with cast iron cover		Dimensions mm					Unit mass (approx.) kg				
	Double-side rubber sealed cover	One-side closing cover	Double-side rubber sealed cover	One-side closing cover	t ₁	t ₂	A ₄	H ₃	A ₅	Standard	With cast iron cover			
											With steel cover	With cast iron cover		
P213	S-UKP213;H2313X	SM-UKP213;H2313X	C-UKP213;H2313X	CM-UKP213;H2313X	17	21	107	155	120	5.6	5.9	7.4		
PX13					-	-	-	26	-	159	135	7	-	9.2
P313					-	-	-	-	25	-	190	140	10	-
P215	-	-	C-UKP215;H2315X	CM-UKP215;H2315X	-	24	-	168	135	7.6	-	9.9		
PX15					-	-	-	29	-	181	145	10	-	13
P315					-	-	-	-	26	-	210	150	14	-
P216	-	-	C-UKP216;H2316X	CM-UKP216;H2316X	-	27	-	181	145	9.2	-	12		
PX16					-	-	-	31	-	198	155	14	-	17
P316					-	-	-	-	24	-	221	155	17	-
P217	-	-	C-UKP217;H2317X	CM-UKP217;H2317X	-	30	-	191	155	11	-	14		
PX17					-	-	-	35	-	204	165	15	-	18
P317					-	-	-	-	29	-	235	170	19	-
P218	-	-	C-UKP218;H2318X	CM-UKP218;H2318X	-	35	-	204	165	13	-	16		
PX18					-	-	-	41	-	208	180	16	-	20
P318					-	-	-	-	27	-	246	170	22	-
P319	-	-	C-UKP319;H2319X	CM-UKP319;H2319X	-	29	-	258	180	27	-	33		
PX20	-	-	C-UKP320;H2320X	CM-UKP320;H2320X	-	43	-	244	195	24	-	28		
P320	-	-			-	29	-	283	190	33	-	39		
P322	-	-	C-UKP322;H2322X	CM-UKP322;H2322X	-	30	-	313	200	43	-	54		
P324	-	-			-	32	-	335	215	50	-	67		
P326	-	-	C-UKP326;H2326	CM-UKP326;H2326	-	34	-	375	225	69	-	86		
P328	-	-			-	36	-	407	235	84	-	101		

2) Unit numbers with the suffix "X" signify narrow slit type adapters, and use washers with straight inner tabs.
3) The unit numbers indicate the oil-free type, and supplementary suffix "D1" is added after the number for the oil feeding type.

Cast iron square flanged unit UCF type / cylindrical bore type, setscrew type

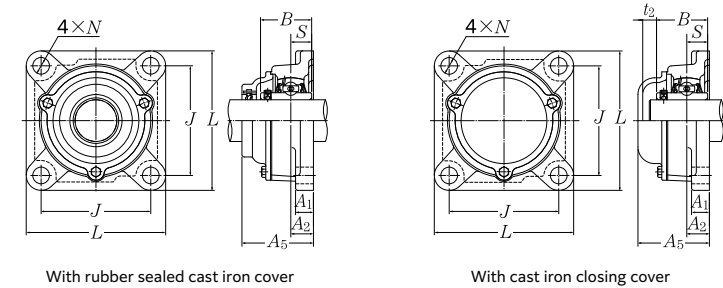
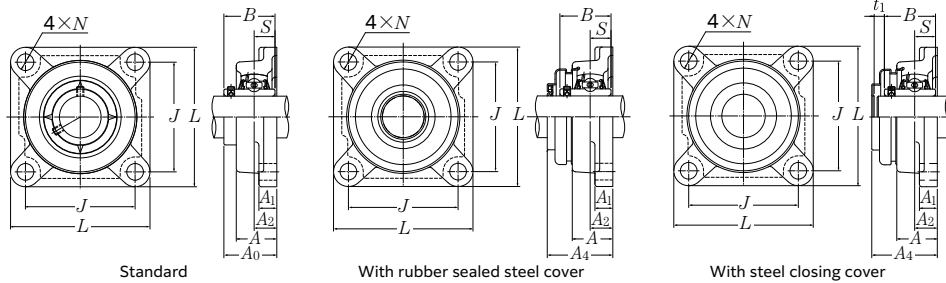

Shaft diameter: 12 to 60 mm

Shaft dia. mm	Unit number ⁽¹⁾⁽²⁾	Dimensions mm									Fixing bolt	Number	Bearing		
		L	J	A ₂	A ₁	A	N	A ₀	B	S			C _r	C _{0r}	C _u
12	UCF201	86	64	15	11	25.5	12	33.3	31	12.7	M10	UC201D1	14.2	6.65	0.505
15	UCF202	86	64	15	11	25.5	12	33.3	31	12.7	M10	UC202D1	14.2	6.65	0.505
17	UCF203	86	64	15	11	25.5	12	33.3	31	12.7	M10	UC203D1	14.2	6.65	0.505
20	UCF204	86	64	15	11	25.5	12	33.3	31	12.7	M10	UC204D1	14.2	6.65	0.505
25	UCF205	95	70	16	13	27	12	35.8	34.1	14.3	M10	UC205D1	15.5	7.85	0.55
	UCFX05	108	83	18	13	30	12	40.2	38.1	15.9	M10	UCX05D1	21.6	11.3	0.795
	UCF305	110	80	16	13	29	16	39	38	15	M14	UC305D1	23.5	10.9	0.855
30	UCF206	108	83	18	13	31	12	40.2	38.1	15.9	M10	UC206D1	21.6	11.3	0.795
	UCFX06	117	92	19	14	34	16	44.4	42.9	17.5	M14	UCX06D1	28.4	15.3	1.09
	UCF306	125	95	18	15	32	16	44	43	17	M14	UC306D1	29.5	15.0	1.14
35	UCF207	117	92	19	15	34	14	44.4	42.9	17.5	M12	UC207D1	28.4	15.3	1.09
	UCFX07	130	102	21	14	38	16	51.2	49.2	19	M14	UCX07D1	32.5	17.8	1.24
	UCF307	135	100	20	16	36	19	49	48	19	M16	UC307D1	37.0	19.1	1.47
40	UCF208	130	102	21	15	36	16	51.2	49.2	19	M14	UC208D1	32.5	17.8	1.24
	UCFX08	137	105	22	14	40	19	52.2	49.2	19	M16	UCX08D1	36.0	20.4	1.60
	UCF308	150	112	23	17	40	19	56	52	19	M16	UC308D1	45.0	24.0	1.83
45	UCF209	137	105	22	16	38	16	52.2	49.2	19	M14	UC209D1	36.0	20.4	1.60
	UCFX09	143	111	23	14	40	19	55.6	51.6	19	M16	UCX09D1	39.0	23.2	1.82
	UCF309	160	125	25	18	44	19	60	57	22	M16	UC309D1	58.5	32.0	2.50
50	UCF210	143	111	22	16	40	16	54.6	51.6	19	M14	UC210D1	39.0	23.2	1.82
	UCFX10	162	130	26	20	44	19	59.4	55.6	22.2	M16	UCX10D1	48.0	29.2	2.29
	UCF310	175	132	28	19	48	23	67	61	22	M20	UC310D1	68.5	38.5	2.99
55	UCF211	162	130	25	18	43	19	58.4	55.6	22.2	M16	UC211D1	48.0	29.2	2.29
	UCFX11	175	143	29	20	49	19	68.7	65.1	25.4	M16	UCX11D1	58.0	36.0	2.83
	UCF311	185	140	30	20	52	23	71	66	25	M20	UC311D1	79.5	45.0	3.50
60	UCF212	175	143	29	18	48	19	68.7	65.1	25.4	M16	UC212D1	58.0	36.0	2.83
	UCFX12	187	149	34	21	59	19	73.7	65.1	25.4	M16	UCX12D1	63.5	40.0	3.15
	UCF312	195	150	33	22	56	23	78	71	26	M20	UC312D1	90.5	52.0	4.10

1) Spherical graphite cast iron bearings are also available based on request. In this case, a supplementary suffix "N1" is added after the unit number. Example: UCF210N1
 2) The unit numbers indicate the oil-free type, and supplementary suffix "D1" is added after the number for the oil feeding type.

Standard housing number	Number of unit with steel cover		Number of unit with cast iron cover		Dimensions mm					Unit mass (approx.) kg		
	Rubber sealed cover	Closing cover	Rubber sealed cover	Closing cover	t ₁	t ₂	A ₄	A ₅	Standard	With steel cover	With cast iron cover	
F204	S-UCF201	SM-UCF201	C-UCF201	CM-UCF201	5	8	40.5	46	0.6	0.6	0.8	
F204	S-UCF202	SM-UCF202	C-UCF202	CM-UCF202	5	8	40.5	46	0.6	0.6	0.8	
F204	S-UCF203	SM-UCF203	C-UCF203	CM-UCF203	5	8	40.5	46	0.6	0.6	0.8	
F204	S-UCF204	SM-UCF204	C-UCF204	CM-UCF204	5	8	40.5	46	0.6	0.6	0.7	
F205	S-UCF205	SM-UCF205	C-UCF205	CM-UCF205	7	11	44.5	51	0.8	0.8	0.9	
FX05	-	-	C-UCFX05	CM-UCFX05	7	11	49	56	1.1	1.2	1.3	
F305	-	-	C-UCF305	CM-UCF305	-	12	-	56	1.1	-	1.4	
F206	S-UCF206	SM-UCF206	C-UCF206	CM-UCF206	7	11	49	56	1.1	1.1	1.3	
FX06	-	-	C-UCFX06	CM-UCFX06	8	10	55	59	1.6	1.8	1.9	
F306	-	-	C-UCF306	CM-UCF306	-	11	-	60	1.6	-	2.1	
F207	S-UCF207	SM-UCF207	C-UCF207	CM-UCF207	8	10	55	59	1.5	1.5	1.8	
FX07	S-UCFX07	SM-UCFX07	C-UCFX07	CM-UCFX07	8	9	62	66	2.1	2.2	2.5	
F307	-	-	C-UCF307	CM-UCF307	-	14	-	68	2.1	-	2.6	
F208	S-UCF208	SM-UCF208	C-UCF208	CM-UCF208	8	9	62	66	1.7	1.8	2.2	
FX08	S-UCFX08	SM-UCFX08	C-UCFX08	CM-UCFX08	8	12	63	70	2.3	2.4	2.7	
F308	-	-	C-UCF308	CM-UCF308	-	14	-	76	2.7	-	3.4	
F209	S-UCF209	SM-UCF209	C-UCF209	CM-UCF209	8	12	63	70	2.1	2.2	2.6	
FX09	S-UCFX09	SM-UCFX09	C-UCFX09	CM-UCFX09	7	12	65.5	73	2.5	2.6	3	
F309	-	-	C-UCF309	CM-UCF309	-	14	-	80	3.4	-	4.3	
F210	S-UCF210	SM-UCF210	C-UCF210	CM-UCF210	8	12	65.5	72	2.5	2.5	3	
FX10	S-UCFX10	SM-UCFX10	C-UCFX10	CM-UCFX10	9	11	71	76	3.8	3.9	4.3	
F310	-	-	C-UCF310	CM-UCF310	-	15	-	88	4.5	-	5.8	
F211	S-UCF211	SM-UCF211	C-UCF211	CM-UCF211	10	11	71	75	3.3	3.4	4	
FX11	S-UCFX11	SM-UCFX11	C-UCFX11	CM-UCFX11	8	12	80	86	4.8	5	5.5	
F311	-	-	C-UCF311	CM-UCF311	-	15	-	92	5.3	-	6.7	
F212	S-UCF212	SM-UCF212	C-UCF212	CM-UCF212	8	12	80	86	3.9	4.1	4.8	
FX12	S-UCFX12	SM-UCFX12	C-UCFX12	CM-UCFX12	7	15	83.5	94	6.4	6.6	7.3	
F312	-	-	C-UCF312	CM-UCF312	-	16	-	100	6.3	-	7.8	

Cast iron square flanged unit UCF type / cylindrical bore type, setscrew type

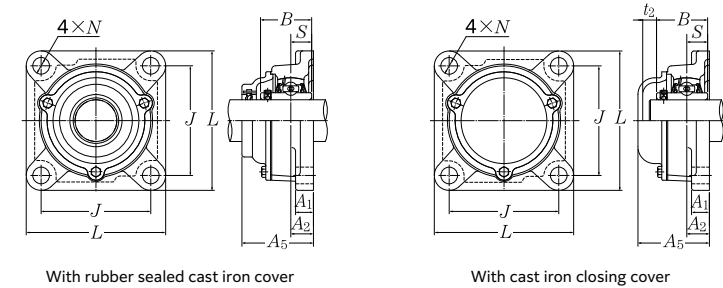
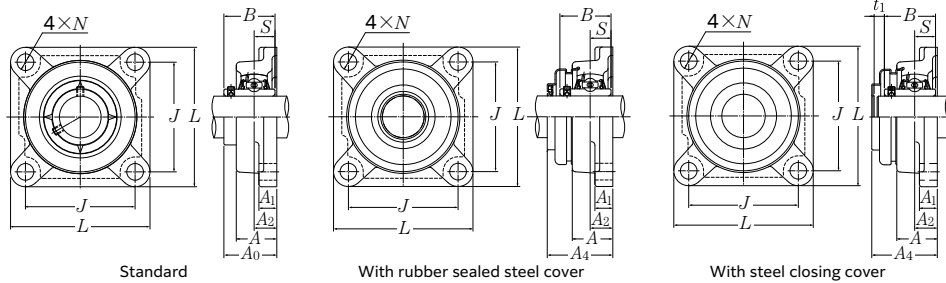

Shaft diameter: 65 to 140 mm

Shaft dia. mm	Unit number ^(1,2)	Dimensions mm										Fixing bolt	Number	Bearing		
		L	J	A ₂	A ₁	A	N	A ₀	B	S	C _r			C _{0r}	C _u	
																Basic load rating dynamic kN
65	UCF213	187	149	30	22	50	19	69.7	65.1	25.4	M16	UC213D1	63.5	40.0	3.15	
	UCFX13	187	149	34	21	59	19	78.4	74.6	30.2	M16	UCX13D1	69.0	44.0	3.45	
	UCF313	208	166	33	22	58	23	78	75	30	M20	UC313D1	103	60.0	4.60	
70	UCF214	193	152	31	22	54	19	75.4	74.6	30.2	M16	UC214D1	69.0	44.0	3.45	
	UCFX14	197	152	37	24	60	23	81.5	77.8	33.3	M20	UCX14D1	73.5	49.5	3.80	
	UCF314	226	178	36	25	61	25	81	78	33	M22	UC314D1	115	68.0	5.10	
75	UCF215	200	159	34	22	56	19	78.5	77.8	33.3	M16	UC215D1	73.5	49.5	3.80	
	UCFX15	197	152	40	24	68	23	89.3	82.6	33.3	M20	UCX15D1	80.5	53.0	3.95	
	UCF315	236	184	39	25	66	25	89	82	32	M22	UC315D1	126	77.0	5.55	
80	UCF216	208	165	34	22	58	23	83.3	82.6	33.3	M20	UC216D1	80.5	53.0	3.95	
	UCFX16	214	171	40	24	70	23	91.6	85.7	34.1	M20	UCX16D1	92.0	64.0	4.60	
	UCF316	250	196	38	27	68	31	90	86	34	M27	UC316D1	136	86.5	6.05	
85	UCF217	220	175	36	24	63	23	87.6	85.7	34.1	M20	UC217D1	92.0	64.0	4.60	
	UCFX17	214	171	40	24	70	23	96.3	96	39.7	M20	UCX17D1	106	71.5	5.00	
	UCF317	260	204	44	27	74	31	100	96	40	M27	UC317D1	147	97.0	6.55	
90	UCF218	235	187	40	24	68	23	96.3	96	39.7	M20	UC218D1	106	71.5	5.00	
	UCFX18	214	171	45	24	76	23	106.1	104	42.9	M20	UCX18D1	121	82.0	5.55	
	UCF318	280	216	44	30	76	35	100	96	40	M30	UC318D1	158	107	7.10	
95	UCF319	290	228	59	30	94	35	121	103	41	M30	UC319D1	169	119	7.65	
100	UCFX20	268	211	59 ³⁾	31	97	31	127.3	117.5	49.2	M27	UCX20D1	147	105	6.75	
	UCF320	310	242	59	32	94	38	125	108	42	M33	UC320D1	192	141	8.75	
105	UCF321	310	242	59	32	94	38	127	112	44	M33	UC321D1	204	153	9.35	
110	UCF322	340	266	60	35	96	41	131	117	46	M36	UC322D1	227	179	10.5	
120	UCF324	370	290	65	40	110	41	140	126	51	M36	UC324D1	229	185	10.5	
130	UCF326	410	320	65	45	115	41	146	135	54	M36	UC326D1	254	214	11.7	
140	UCF328	450	350	75	55	125	41	161	145	59	M36	UC328D1	280	246	13.0	

1) Spherical graphite cast iron bearings are also available based on request. In this case, a supplementary suffix "N1" is added after the unit number. Example: UCF320N1
 2) The unit numbers indicate the oil-free type, and supplementary suffix "D1" is added after the number for the oil feeding type.
 3) Dimension A₂ becomes 49 in the case of a unit with a cast iron cover.

Standard housing number	Number of unit with steel cover		Number of unit with cast iron cover		Dimensions mm					Unit mass (approx.) kg		
	Rubber sealed cover	Closing cover	Rubber sealed cover	Closing cover	t ₁	t ₂	A ₄	A ₅	Standard	With steel cover	With cast iron cover	
F213	S-UCF213	SM-UCF213	C-UCF213	CM-UCF213	11	15	83.5	90	5.5	5.6	6.4	
FX13	-	-	C-UCFX13	CM-UCFX13	-	16	-	101	6.6	-	7.8	
F313	-	-	C-UCF313	CM-UCF313	-	19	-	103	8	-	9.7	
F214	-	-	C-UCF214	CM-UCF214	-	16	-	98	6.3	-	7.4	
FX14	-	-	C-UCFX14	CM-UCFX14	-	17	-	105	7.1	-	8.3	
F314	-	-	C-UCF314	CM-UCF314	-	19	-	106	9.4	-	11	
F215	-	-	C-UCF215	CM-UCF215	-	17	-	102	6.6	-	7.8	
FX15	-	-	C-UCFX15	CM-UCFX15	-	16	-	112	8.6	-	9.9	
F315	-	-	C-UCF315	CM-UCF315	-	19	-	114	11	-	13	
F216	-	-	C-UCF216	CM-UCF216	-	16	-	106	7.9	-	9.2	
FX16	-	-	C-UCFX16	CM-UCFX16	-	20	-	118	11	-	12	
F316	-	-	C-UCF316	CM-UCF316	-	19	-	116	14	-	16	
F217	-	-	C-UCF217	CM-UCF217	-	20	-	114	9.8	-	12	
FX17	-	-	C-UCFX17	CM-UCFX17	-	19	-	122	12	-	14	
F317	-	-	C-UCF317	CM-UCF317	-	21	-	129	15	-	19	
F218	-	-	C-UCF218	CM-UCF218	-	19	-	122	12	-	13	
FX18	-	-	C-UCFX18	CM-UCFX18	-	22	-	135	13	-	15	
F318	-	-	C-UCF318	CM-UCF318	-	21	-	129	19	-	23	
F319	-	-	C-UCF319	CM-UCF319	-	20	-	149	22	-	25	
FX20	-	-	C-UCFX20	CM-UCFX20	-	23	-	146.5	21	-	23	
F320	-	-	C-UCF320	CM-UCF320	-	20	-	154	27	-	32	
F321	-	-	C-UCF321	CM-UCF321	-	20	-	156	26	-	32	
F322	-	-	C-UCF322	CM-UCF322	-	20	-	160	34	-	40	
F324	-	-	C-UCF324	CM-UCF324	-	22	-	172	48	-	56	
F326	-	-	C-UCF326	CM-UCF326	-	22	-	178	63	-	73	
F328	-	-	C-UCF328	CM-UCF328	-	21	-	192	90	-	100	

Round flange with cast iron spigot joint UCFC type / cylindrical bore type, setscrew type

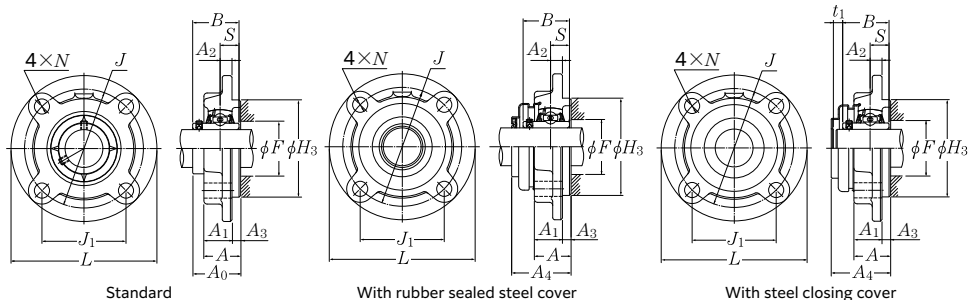

Shaft diameter: 12 to 70 mm

Shaft dia. mm	Unit number ^(1,2)	Dimensions mm													Fixing bolt	Number	Bearing			
		L	J	(J ₁)	A ₂	N	A ₃	A ₁	A ₁	A	H ₃	A ₀	B	S			F _(Min)	Basic load ratings dynamic	static	Fatigue load limit
12	UCFC201	100	78	55.2	10	12	5	20.5	20.5	25.5	62	33.3	31	12.7	-	M10	UC201D1	14.2	6.65	0.505
15	UCFC202	100	78	55.2	10	12	5	20.5	20.5	25.5	62	33.3	31	12.7	-	M10	UC202D1	14.2	6.65	0.505
17	UCFC203	100	78	55.2	10	12	5	20.5	20.5	25.5	62	33.3	31	12.7	-	M10	UC203D1	14.2	6.65	0.505
20	UCFC204	100	78	55.2	10	12	5	20.5	20.5	25.5	62	33.3	31	12.7	-	M10	UC204D1	14.2	6.65	0.505
25	UCFC205	115	90	63.6	10	12	6	21	22	27	70	35.8	34.1	14.3	-	M10	UC205D1	15.5	7.85	0.55
	UCFCX05	111	92	65.1	10	9.5	6	24	-	30	76	38.2	38.1	15.9	46	M 8	UCX05D1	21.6	11.3	0.795
30	UCFC206	125	100	70.7	10	12	8	23	24.5	31	80	40.2	38.1	15.9	-	M10	UC206D1	21.6	11.3	0.795
	UCFCX06	127	105	74.2	8	12	9.5	22.5	-	32	85	42.9	42.9	17.5	52	M10	UCX06D1	28.4	15.3	1.09
35	UCFC207	135	110	77.8	11	14	8	26	26	34	90	44.4	42.9	17.5	-	M12	UC207D1	28.4	15.3	1.09
	UCFCX07	133	111	78.5	9	12	11	26	-	37	92	50.2	49.2	19	59	M10	UCX07D1	32.5	17.8	1.24
40	UCFC208	145	120	84.9	11	14	10	26	27.5	36	100	51.2	49.2	19	-	M12	UC208D1	32.5	17.8	1.24
	UCFCX08	133	111	78.5	9	12	11	26	-	37	92	50.2	49.2	19	63	M10	UCX08D1	36.0	20.4	1.60
45	UCFC209	160	132	93.3	10	16	12	26	28	38	105	52.2	49.2	19	-	M14	UC209D1	36.0	20.4	1.60
	UCFCX09	155	130	91.9	8	14	12	25	-	37	108	52.6	51.6	19	68	M12	UCX09D1	39.0	23.2	1.82
50	UCFC210	165	138	97.6	10	16	12	28	29	40	110	54.6	51.6	19	-	M14	UC210D1	39.0	23.2	1.82
	UCFCX10	162	136	96.2	7	14	16	25	-	41	118	56.4	55.6	22.2	75	M12	UCX10D1	48.0	29.2	2.29
55	UCFC211	185	150	106.1	13	19	12	31	32.5	43	125	58.4	55.6	22.2	-	M16	UC211D1	48.0	29.2	2.29
	UCFCX11	180	152	107.5	4	16	22	26	-	48	127	65.7	65.1	25.4	83	M14	UCX11D1	58.0	36.0	2.83
60	UCFC212	195	160	113.1	17	19	12	36	38	48	135	68.7	65.1	25.4	-	M16	UC212D1	58.0	36.0	2.83
	UCFCX12	194	165	116.7	11	16	20	33	-	53	140	70.7	65.1	25.4	-	M14	UCX12D1	63.5	40.0	3.15
65	UCFC213	205	170	120.2	16	19	14	36	38	50	145	69.7	65.1	25.4	-	M16	UC213D1	63.5	40.0	3.15
	UCFCX13	194	165	116.7	11	16	20	33	-	53	140	75.4	74.6	30.2	94	M14	UCX13D1	69.0	44.0	3.45
70	UCFC214	215	177	125.2	17	19	14	40	39.5	54	150	75.4	74.6	30.2	94	M16	UC214D1	69.0	44.0	3.45
	UCFCX14	222	190	134.4	14	19	20	36	-	56	164	78.5	77.8	33.3	100	M16	UCX14D1	73.5	49.5	3.80

1) Spherical graphite cast iron bearings are also available based on request. In this case, a supplementary suffix "N1" is added after the unit number. Example: UCFC210N1
 2) The unit numbers indicate the oil-free type, and supplementary suffix "D1" is added after the number for the oil feeding type.

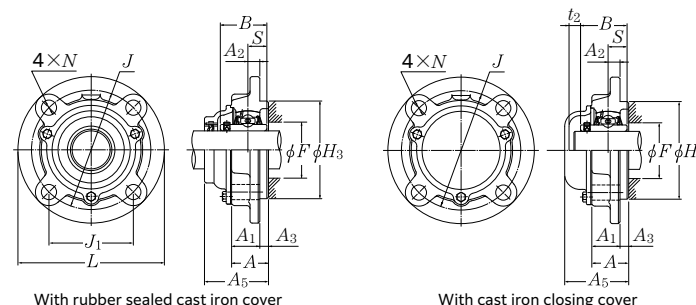

Standard housing number	Number of unit with steel cover		Number of unit with cast iron cover		Dimensions mm				Unit mass (approx.) kg		
	Rubber sealed cover	Closing cover	Rubber sealed cover	Closing cover	t ₁	t ₂	A ₄	A ₅	Standard	With steel cover	With cast iron cover
FC204	S-UCFC201	SM-UCFC201	C-UCFC201	CM-UCFC201	5	8	40.5	46	0.8	0.8	0.9
FC204	S-UCFC202	SM-UCFC202	C-UCFC202	CM-UCFC202	5	8	40.5	46	0.8	0.8	0.9
FC204	S-UCFC203	SM-UCFC203	C-UCFC203	CM-UCFC203	5	8	40.5	46	0.8	0.8	0.9
FC204	S-UCFC204	SM-UCFC204	C-UCFC204	CM-UCFC204	5	8	40.5	46	0.7	0.7	0.9
FC205	S-UCFC205	SM-UCFC205	C-UCFC205	CM-UCFC205	7	11	44.5	51	1	1	1.2
FCX05	-	-	-	-	-	-	-	-	1.2	-	-
FC206	S-UCFC206	SM-UCFC206	C-UCFC206	CM-UCFC206	7	11	49	56	1.3	1.4	1.6
FCX06	-	-	-	-	-	-	-	-	1.5	-	-
FC207	S-UCFC207	SM-UCFC207	C-UCFC207	CM-UCFC207	8	10	55	59	1.6	1.7	1.9
FCX07	-	-	-	-	-	-	-	-	1.9	-	-
FC208	S-UCFC208	SM-UCFC208	C-UCFC208	CM-UCFC208	8	9	62	66	2	2.1	2.4
FCX08	-	-	-	-	-	-	-	-	2	-	-
FC209	S-UCFC209	SM-UCFC209	C-UCFC209	CM-UCFC209	8	12	63	70	2.7	2.7	3.2
FCX09	-	-	-	-	-	-	-	-	2.6	-	-
FC210	S-UCFC210	SM-UCFC210	C-UCFC210	CM-UCFC210	8	12	65.5	72	3	3.1	3.6
FCX10	-	-	-	-	-	-	-	-	3.1	-	-
FC211	S-UCFC211	SM-UCFC211	C-UCFC211	CM-UCFC211	10	11	71	75	4	4.2	4.8
FCX11	-	-	-	-	-	-	-	-	4.2	-	-
FC212	S-UCFC212	SM-UCFC212	C-UCFC212	CM-UCFC212	8	12	80	86	4.9	5.1	5.9
FCX12	-	-	-	-	-	-	-	-	5.5	-	-
FC213	S-UCFC213	SM-UCFC213	C-UCFC213	CM-UCFC213	11	14	83.5	89.5	5.8	6	6.8
FCX13	-	-	-	-	-	-	-	-	5.7	-	-
FC214	-	-	C-UCFC214	CM-UCFC214	-	16	-	98	7	-	8
FCX14	-	-	-	-	-	-	-	-	7.3	-	-

Bearing Units

NTN

Round flange with cast iron spigot joint UCFC type / cylindrical bore type, setscrew type

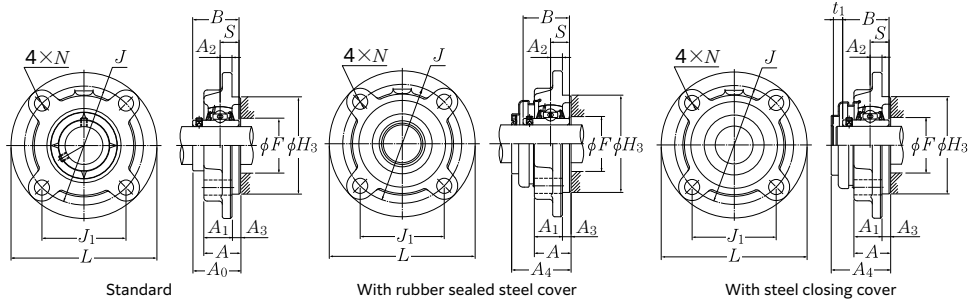

Shaft diameter: 75 to 100 mm

Shaft dia. mm	Unit number ^(1,2)	Dimensions mm													Fixing bolt	Number	Bearing			
		L	J	(J ₁)	A ₂	N	A ₃	A ₁	A ₁	A	H ₃	A ₀	B	S			F (Min.)	Basic load ratings dynamic	static	Fatigue load limit
															C _r	C _{0r}	C _u			
75	UCFC215	220	184	130.1	18	19	16	40	43	56	160	78.5	77.8	33.3	100	M16	UC215D1	73.5	49.5	3.80
	UCFCX15	222	190	134.4	12	19	22	35	-	57	164	83.3	82.6	33.3	105	M16	UCX15D1	80.5	53.0	3.95
80	UCFC216	240	200	141.4	18	23	16	42	43	58	170	83.3	82.6	33.3	105	M20	UC216D1	80.5	53.0	3.95
	UCFCX16	260	219	154.9	10	23	25	36	-	61	186	86.6	85.7	34.1	113	M20	UCX16D1	92.0	64.0	4.60
85	UCFC217	250	208	147.1	18	23	18	45	45.5	63	180	87.6	85.7	34.1	113	M20	UC217D1	92.0	64.0	4.60
	UCFCX17	260	219	154.9	10	23	25	36	-	61	186	91.3	96	39.7	119	M20	UCX17D1	106	71.5	5.00
90	UCFC218	265	220	155.6	22	23	18	50	50	68	190	96.3	96	39.7	119	M20	UC218D1	106	71.5	5.00
	UCFCX18	260	219	154.9	12	23	28	43	-	71	186	101.1	104	42.9	126	M20	UCX18D1	121	82.0	5.55
100	UCFCX20	276	238	168.3	22	23	28	66	-	94	206	118.3	117.5	49.2	139	M20	UCX20D1	147	105	6.75

Bearing Units

NTN

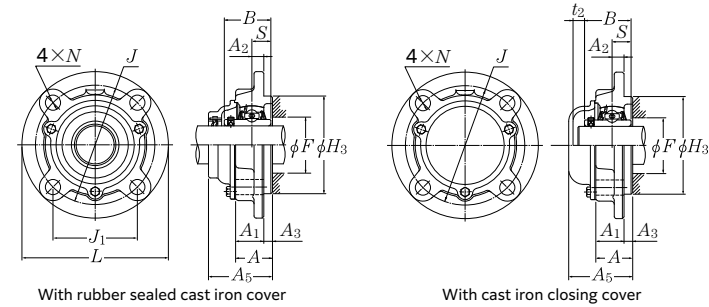

Standard housing number	Number of unit with steel cover		Number of unit with cast iron cover		Dimensions mm				Unit mass (approx.) kg		
	Rubber sealed cover	Closing cover	Rubber sealed cover	Closing cover	t ₁	t ₂	A ₄	A ₅	Standard	With steel cover	With cast iron cover
FC215	-	-	C-UCFC215	CM-UCFC215	-	17	-	102	7.4	-	8.8
FCX15	-	-	-	-	-	-	-	-	8	-	-
FC216	-	-	C-UCFC216	CM-UCFC216	-	16	-	106	9.1	-	10
FCX16	-	-	-	-	-	-	-	-	12	-	-
FC217	-	-	C-UCFC217	CM-UCFC217	-	20	-	114	11	-	12
FCX17	-	-	-	-	-	-	-	-	12	-	-
FC218	-	-	C-UCFC218	CM-UCFC218	-	19	-	122	13	-	15
FCX18	-	-	-	-	-	-	-	-	12	-	-
FCX20	-	-	-	-	-	-	-	-	18	-	-

1) Spherical graphite cast iron bearings are also available based on request. In this case, a supplementary suffix "N1" is added after the unit number. Example: UCFC218N1

2) The unit numbers indicate the oil-free type, and supplementary suffix "D1" is added after the number for the oil feeding type.

Cast iron rhombus flanged unit UCFL type / cylindrical bore type, setscrew type

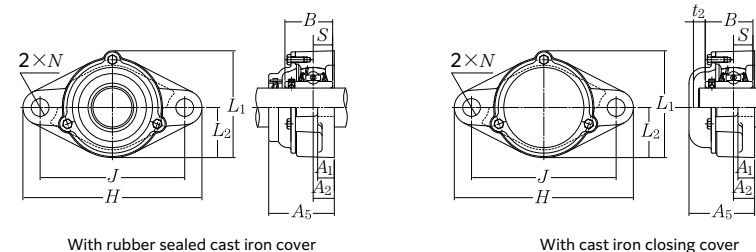
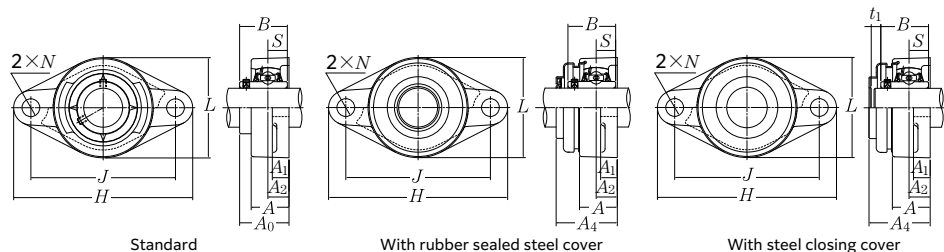

Shaft diameter: 12 to 60 mm

Shaft dia. mm	Unit number ¹⁾²⁾	Dimensions mm										Fixing bolt	Number	Bearing		
		H	J	A ₂	A ₁	A	N	L	A ₀	B	S			C _r	C _{0r}	C _u
12	UCFL201	113	90	15	11	25.5	12	60	33.3	31	12.7	M10	UC201D1	14.2	6.65	0.505
15	UCFL202	113	90	15	11	25.5	12	60	33.3	31	12.7	M10	UC202D1	14.2	6.65	0.505
17	UCFL203	113	90	15	11	25.5	12	60	33.3	31	12.7	M10	UC203D1	14.2	6.65	0.505
20	UCFL204	113	90	15	11	25.5	12	60	33.3	31	12.7	M10	UC204D1	14.2	6.65	0.505
25	UCFL205	130	99	16	13	27	16	68	35.8	34.1	14.3	M14	UC205D1	15.5	7.85	0.55
	UCFLX05	141	117	18	13	30	12	83	40.2	38.1	15.9	M10	UCX05D1	21.6	11.3	0.795
	UCFL305	150	113	16	13	29	19	80	39	38	15	M16	UC305D1	23.5	10.9	0.855
30	UCFL206	148	117	18	13	31	16	80	40.2	38.1	15.9	M14	UC206D1	21.6	11.3	0.795
	UCFLX06	156	130	19	15	34	16	95	44.4	42.9	17.5	M14	UCX06D1	28.4	15.3	1.09
	UCFL306	180	134	18	15	32	23	90	44	43	17	M20	UC306D1	29.5	15.0	1.14
35	UCFL207	161	130	19	15	34	16	90	44.4	42.9	17.5	M14	UC207D1	28.4	15.3	1.09
	UCFLX07	171	144	21	16	38	16	105	51.2	49.2	19	M14	UCX07D1	32.5	17.8	1.24
	UCFL307	185	141	20	16	36	23	100	49	48	19	M20	UC307D1	37.0	19.1	1.47
40	UCFL208	175	144	21	15	36	16	100	51.2	49.2	19	M14	UC208D1	32.5	17.8	1.24
	UCFLX08	179	148	22	16	40	16	111	52.2	49.2	19	M14	UCX08D1	36.0	20.4	1.60
	UCFL308	200	158	23	17	40	23	112	56	52	19	M20	UC308D1	45.0	24.0	1.83
45	UCFL209	188	148	22	16	38	19	108	52.2	49.2	19	M16	UC209D1	36.0	20.4	1.60
	UCFLX09	189	157	23	16	40	16	116	55.6	51.6	19	M14	UCX09D1	39.0	23.2	1.82
	UCFL309	230	177	25	18	44	25	125	60	57	22	M22	UC309D1	58.5	32.0	2.50
50	UCFL210	197	157	22	16	40	19	115	54.6	51.6	19	M16	UC210D1	39.0	23.2	1.82
	UCFLX10	216	184	26	18	44	19	133	59.4	55.6	22.2	M16	UCX10D1	48.0	29.2	2.29
	UCFL310	240	187	28	19	48	25	140	67	61	22	M22	UC310D1	68.5	38.5	2.99
55	UCFL211	224	184	25	18	43	19	130	58.4	55.6	22.2	M16	UC211D1	48.0	29.2	2.29
	UCFL311	250	198	30	20	52	25	150	71	66	25	M22	UC311D1	79.5	45.0	3.50
60	UCFL212	250	202	29	18	48	23	140	68.7	65.1	25.4	M20	UC212D1	58.0	36.0	2.83
	UCFL312	270	212	33	22	56	31	160	78	71	26	M27	UC312D1	90.5	52.0	4.10

1) Spherical graphite cast iron bearings are also available based on request. In this case, a supplementary suffix "N1" is added after the unit number. Example: UCFL210N1
 2) The unit numbers indicate the oil-free type, and supplementary suffix "D1" is added after the number for the oil feeding type.

Standard housing number	Number of unit with steel cover		Number of unit with cast iron cover		Dimensions mm						Unit mass (approx.) kg		
	Rubber sealed cover	Closing cover	Rubber sealed cover	Closing cover	t ₁	t ₂	A ₄	A ₅	L ₁	L ₂	Standard	With steel cover	With cast iron cover
FL204	S-UCFL201	SM-UCFL201	C-UCFL201	CM-UCFL201	5	8	40.5	46	67	30	0.5	0.5	0.6
FL204	S-UCFL202	SM-UCFL202	C-UCFL202	CM-UCFL202	5	8	40.5	46	67	30	0.5	0.5	0.6
FL204	S-UCFL203	SM-UCFL203	C-UCFL203	CM-UCFL203	5	8	40.5	46	67	30	0.5	0.5	0.6
FL204	S-UCFL204	SM-UCFL204	C-UCFL204	CM-UCFL204	5	8	40.5	46	67	30	0.4	0.4	0.6
FL205	S-UCFL205	SM-UCFL205	C-UCFL205	CM-UCFL205	7	11	44.5	51	74	34	0.6	0.6	0.8
FLX05	S-UCFLX05	SM-UCFLX05	C-UCFLX05	CM-UCFLX05	7	11	49	56	86	41.5	1	1	1.2
FL305	-	-	C-UCFL305	CM-UCFL305	-	12	-	56	86	40	0.9	-	1.2
FL206	S-UCFL206	SM-UCFL206	C-UCFL206	CM-UCFL206	7	11	49	56	85	40	0.8	0.9	1.2
FLX06	S-UCFLX06	SM-UCFLX06	C-UCFLX06	CM-UCFLX06	8	10	55	59	98.5	47.5	1.4	1.6	1.8
FL306	-	-	C-UCFL306	CM-UCFL306	-	11	-	60	101	45	1.4	-	1.7
FL207	S-UCFL207	SM-UCFL207	C-UCFL207	CM-UCFL207	8	10	55	59	97	45	1.2	1.2	1.4
FLX07	S-UCFLX07	SM-UCFLX07	C-UCFLX07	CM-UCFLX07	8	9	62	66	108.5	52.5	1.8	1.9	2.2
FL307	-	-	C-UCFL307	CM-UCFL307	-	14	-	68	110	50	1.7	-	2.1
FL208	S-UCFL208	SM-UCFL208	C-UCFL208	CM-UCFL208	8	9	62	66	106	50	1.5	1.5	1.9
FLX08	S-UCFLX08	SM-UCFLX08	C-UCFLX08	CM-UCFLX08	8	12	63	70	114.5	55.5	2	2.1	2.4
FL308	-	-	C-UCFL308	CM-UCFL308	-	14	-	76	122	56	2.2	-	2.9
FL209	S-UCFL209	SM-UCFL209	C-UCFL209	CM-UCFL209	8	12	63	70	113	54	1.8	1.9	2.3
FLX09	S-UCFLX09	SM-UCFLX09	C-UCFLX09	CM-UCFLX09	7	12	65.5	73	119.5	58	2.2	2.3	2.7
FL309	-	-	C-UCFL309	CM-UCFL309	-	14	-	80	135	62	3	-	3.8
FL210	S-UCFL210	SM-UCFL210	C-UCFL210	CM-UCFL210	8	12	65.5	72	120	58	2	2.1	2.7
FLX10	S-UCFLX10	SM-UCFLX10	C-UCFLX10	CM-UCFLX10	9	11	71	76	133.5	66.5	3	3.2	3.6
FL310	-	-	C-UCFL310	CM-UCFL310	-	15	-	88	152	70	4.1	-	5
FL211	S-UCFL211	SM-UCFL211	C-UCFL211	CM-UCFL211	10	11	71	75	133	65	2.9	3	3.4
FL311	-	-	C-UCFL311	CM-UCFL311	-	15	-	92	162	75	4.6	-	5.9
FL212	S-UCFL212	SM-UCFL212	C-UCFL212	CM-UCFL212	8	12	80	86	144	70	3.8	4	4.6
FL312	-	-	C-UCFL312	CM-UCFL312	-	16	-	100	175	80	5.7	-	7.7

Cast iron rhombus flanged unit UCFL type / cylindrical bore type, setscrew type

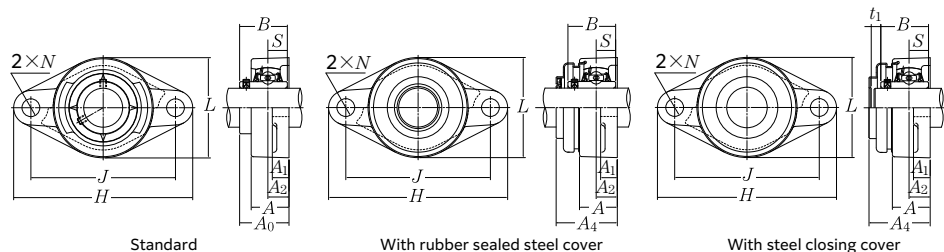

Shaft diameter: 65 to 140 mm

Shaft dia. mm	Unit number ¹⁾²⁾	Dimensions mm										Fixing bolt	Number	Bearing		
		H	J	A ₂	A ₁	A	N	L	A ₀	B	S			C _r	Basic load ratings dynamic kN C _{0r}	Fatigue load limit C _u
65	UCFL213	258	210	30	22	50	23	155	69.7	65.1	25.4	M20	UC213D1	63.5	40.0	3.15
	UCFL313	295	240	33	25	58	31	175	78	75	30	M27	UC313D1	103	60.0	4.60
70	UCFL214	265	216	31	22	54	23	160	75.4	74.6	30.2	M20	UC214D1	69.0	44.0	3.45
	UCFL314	315	250	36	28	61	35	185	81	78	33	M30	UC314D1	115	68.0	5.10
75	UCFL215	275	225	34	22	56	23	165	78.5	77.8	33.3	M20	UC215D1	73.5	49.5	3.80
	UCFL315	320	260	39	30	66	35	195	89	82	32	M30	UC315D1	126	77.0	5.55
80	UCFL216	290	233	34	22	58	25	180	83.3	82.6	33.3	M22	UC216D1	80.5	53.0	3.95
	UCFL316	355	285	38	32	68	38	210	90	86	34	M33	UC316D1	136	86.5	6.05
85	UCFL217	305	248	36	24	63	25	190	87.6	85.7	34.1	M22	UC217D1	92.0	64.0	4.60
	UCFL317	370	300	44	32	74	38	220	100	96	40	M33	UC317D1	147	97.0	6.55
90	UCFL218	320	265	40	24	68	25	205	96.3	96	39.7	M22	UC218D1	106	71.5	5.00
	UCFL318	385	315	44	36	76	38	235	100	96	40	M33	UC318D1	158	107	7.10
95	UCFL319	405	330	59	40	94	41	250	121	103	41	M36	UC319D1	169	119	7.65
100	UCFL320	440	360	59	40	94	44	270	125	108	42	M39	UC320D1	192	141	8.75
105	UCFL321	440	360	59	40	94	44	270	127	112	44	M39	UC321D1	204	153	9.35
110	UCFL322	470	390	60	42	96	44	300	131	117	46	M39	UC322D1	227	179	10.5
120	UCFL324	520	430	65	48	110	47	330	140	126	51	M42	UC324D1	229	185	10.5
130	UCFL326	550	460	65	50	115	47	360	146	135	54	M42	UC326D1	254	214	11.7
140	UCFL328	600	500	75	60	125	51	400	161	145	59	M45	UC328D1	280	246	13.0

1) Spherical graphite cast iron bearings are also available based on request. In this case, a supplementary suffix "N1" is added after the unit number. Example: UCFL215N1
 2) The unit numbers indicate the oil-free type, and supplementary suffix "D1" is added after the number for the oil feeding type.

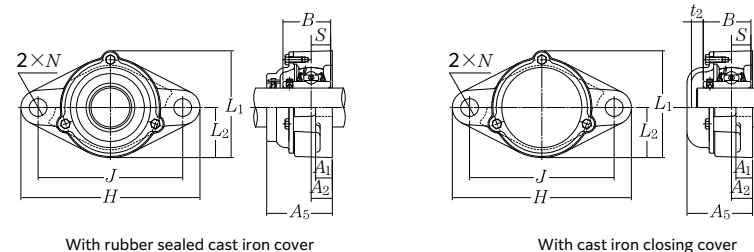

Standard housing number	Number of unit with steel cover		Number of unit with cast iron cover		Dimensions mm						Unit mass (approx.) kg		
	Rubber sealed cover	Closing cover	Rubber sealed cover	Closing cover	t ₁	t ₂	A ₄	A ₅	L ₁	L ₂	Standard	With steel cover	With cast iron cover
FL213	S-UCFL213	SM-UCFL213	C-UCFL213	CM-UCFL213	11	15	83.5	90	157	78	4.8	4.9	5.8
FL313					-	-	19	-	103	189	88	7.5	-
FL214	-	-	C-UCFL214	CM-UCFL214	-	16	-	98	164	80	5.4	-	7.7
FL314	-	-	C-UCFL314	CM-UCFL314	-	19	-	106	198	92	8.6	-	11
FL215	-	-	C-UCFL215	CM-UCFL215	-	17	-	102	169	82	6	-	7.1
FL315	-	-	C-UCFL315	CM-UCFL315	-	19	-	114	210	98	9.8	-	12
FL216	-	-	C-UCFL216	CM-UCFL216	-	16	-	106	183	90	7.4	-	8.6
FL316	-	-	C-UCFL316	CM-UCFL316	-	19	-	116	222	105	13	-	16
FL217	-	-	C-UCFL217	CM-UCFL217	-	20	-	114	192	95	8.8	-	10
FL317	-	-	C-UCFL317	CM-UCFL317	-	19	-	127	234	110	15	-	17
FL218	-	-	C-UCFL218	CM-UCFL218	-	19	-	122	205	102	11	-	13
FL318	-	-	C-UCFL318	CM-UCFL318	-	21	-	129	247	118	17	-	21
FL319	-	-	C-UCFL319	CM-UCFL319	-	20	-	149	260	125	23	-	26
FL320	-	-	C-UCFL320	CM-UCFL320	-	20	-	154	280	135	26	-	31
FL321	-	-	C-UCFL321	CM-UCFL321	-	20	-	156	287	135	27	-	32
FL322	-	-	C-UCFL322	CM-UCFL322	-	20	-	160	315	150	34	-	39
FL324	-	-	C-UCFL324	CM-UCFL324	-	22	-	172	342	165	48	-	52
FL326	-	-	C-UCFL326	CM-UCFL326	-	22	-	178	376	180	58	-	67
FL328	-	-	C-UCFL328	CM-UCFL328	-	21	-	192	410	200	81	-	90

Cast iron take-up unit UCT type / cylindrical bore type, setscrew type

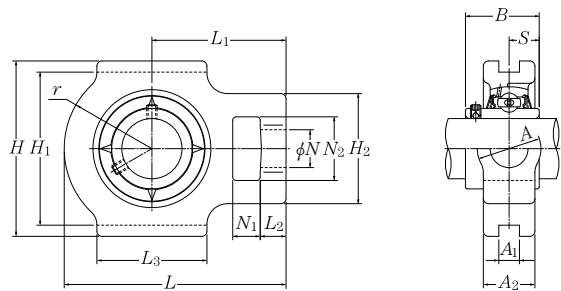

Shaft diameter: 12 to 50 mm

Shaft dia. mm	Unit number ⁽²⁾	Dimensions mm															Number	Bearing			
		N_1	L_2	H_2	N_2	N	L_3	A_1	H_1	H	L	A_2	A	r	L_1	B		S	C_R	Basic load ratings dynamic kN	static kN
12	UCT201	16	12	51	32	19	51	12	76	89	94	21	32	33	61	31	12.7	UC201D1	14.2	6.65	0.505
15	UCT202	16	12	51	32	19	51	12	76	89	94	21	32	33	61	31	12.7	UC202D1	14.2	6.65	0.505
17	UCT203	16	12	51	32	19	51	12	76	89	94	21	32	33	61	31	12.7	UC203D1	14.2	6.65	0.505
20	UCT204	16	12	51	32	19	51	12	76	89	94	21	32	33	61	31	12.7	UC204D1	14.2	6.65	0.505
25	UCT205	16	12	51	32	19	51	12	76	89	97	24	32	35	62	34.1	14.3	UC205D1	15.5	7.85	0.55
	UCTX05	16	12	56	37	22	57	12	89	102	113	28	37	43	70	38.1	15.9	UCX05D1	21.6	11.3	0.795
	UCT305	16	14	62	36	26	65	12	80	89	122	26	36	46	76	38	15	UC305D1	23.5	10.9	0.855
30	UCT206	16	12	56	37	22	57	12	89	102	113	28	37	43	70	38.1	15.9	UC206D1	21.6	11.3	0.795
	UCTX06	16	15	64	37	22	64	12	89	102	129	30	37	51	78	42.9	17.5	UCX06D1	28.4	15.3	1.09
	UCT306	18	16	70	41	28	74	16	90	100	137	28	41	52	85	43	17	UC306D1	29.5	15.0	1.14
35	UCT207	16	15	64	37	22	64	12	89	102	129	30	37	51	78	42.9	17.5	UC207D1	28.4	15.3	1.09
	UCTX07	19	17	83	49	29	83	16	102	114	144	36	49	56	88	49.2	19	UCX07D1	32.5	17.8	1.24
	UCT307	20	17	75	45	30	80	16	100	111	150	32	45	56	94	48	19	UC307D1	37.0	19.1	1.47
40	UCT208	19	18	83	49	29	83	16	102	114	144	33	49	56	88	49.2	19	UC208D1	32.5	17.8	1.24
	UCTX08	19	17	83	49	29	83	16	102	117	144	36	49	57	87	49.2	19	UCX08D1	36.0	20.4	1.60
	UCT308	22	19	83	50	32	89	18	112	124	162	34	50	62	100	52	19	UC308D1	45.0	24.0	1.83
45	UCT209	19	18	83	49	29	83	16	102	117	145	35	49	57	88	49.2	19	UC209D1	36.0	20.4	1.60
	UCTX09	19	18	83	49	29	86	16	102	117	151	38	49	59	92	51.6	19	UCX09D1	39.0	23.2	1.82
	UCT309	24	20	90	55	34	97	18	125	138	178	38	55	68	110	57	22	UC309D1	58.5	32.0	2.50
50	UCT210	19	18	83	49	29	86	16	102	117	151	37	49	59	92	51.6	19	UC210D1	39.0	23.2	1.82
	UCTX10	25	21	102	64	35	95	22	130	146	171	42	64	65	106	55.6	22.2	UCX10D1	48.0	29.2	2.29
	UCT310	27	22	98	61	37	106	20	140	151	192	40	61	74	118	61	22	UC310D1	68.5	38.5	2.99

1) Spherical graphite cast iron bearings are also available based on request. In this case, a supplementary suffix "N1" is added after the number. Example: UCT210N1
 2) The unit numbers indicate the oil-free type, and supplementary suffix "D1" is added after the number for the oil feeding type.

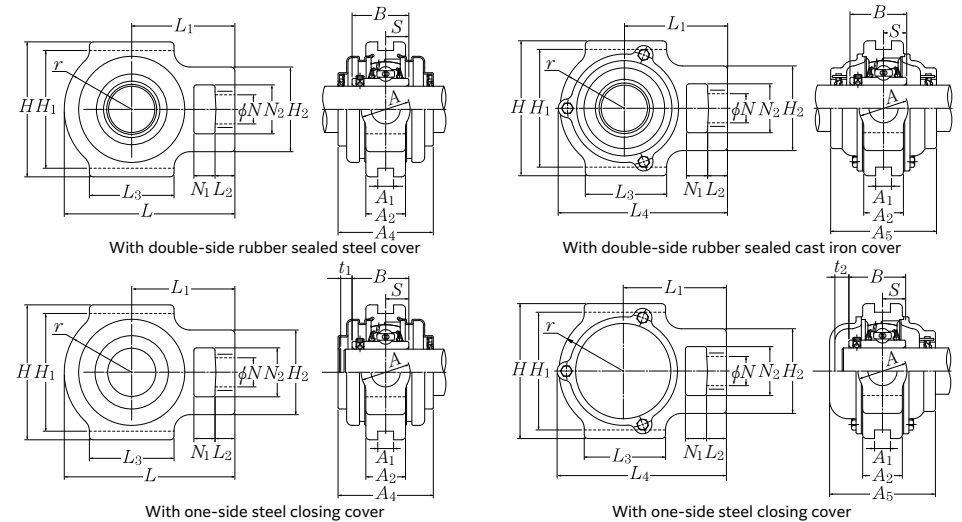

Standard housing number	Number of unit with steel cover		Number of unit with cast iron cover		Dimensions mm			Unit mass (approx.) kg				
	Double-side rubber sealed cover	One-side closing cover	Double-side rubber sealed cover	One-side closing cover	t_1	t_2	A_4	L_4	A_5	Standard	With steel cover	With cast iron cover
T204	S-UCT201	SM-UCT201	C-UCT201	CM-UCT201	5	8	51	97	62	0.6	0.8	1.1
T204	S-UCT202	SM-UCT202	C-UCT202	CM-UCT202	5	8	51	97	62	0.6	0.8	1
T204	S-UCT203	SM-UCT203	C-UCT203	CM-UCT203	5	8	51	97	62	0.6	0.8	1
T204	S-UCT204	SM-UCT204	C-UCT204	CM-UCT204	5	8	51	97	62	0.6	0.8	1
T205	S-UCT205	SM-UCT205	C-UCT205	CM-UCT205	7	11	57	100.5	70	0.8	0.9	1.1
TX05	S-UCTX05	SM-UCTX05	C-UCTX05	CM-UCTX05	7	11	62	113.5	75	1.3	1.5	1.8
T305	-	-	C-UCT305	CM-UCT305	-	12	-	122	80	1.4	-	1.7
T206	S-UCT206	SM-UCT206	C-UCT206	CM-UCT206	7	11	62	113.5	75	1.3	1.3	1.7
TX06	S-UCTX06	SM-UCTX06	C-UCTX06	CM-UCTX06	8	10	72	129	80	1.7	2	2.3
T306	-	-	C-UCT306	CM-UCT306	-	11	-	139	85	1.8	-	2.4
T207	S-UCT207	SM-UCT207	C-UCT207	CM-UCT207	8	10	72	129	80	1.6	1.7	2.1
TX07	S-UCTX07	SM-UCTX07	C-UCTX07	CM-UCTX07	8	9	82	144	90	2.6	2.8	3.5
T307	-	-	C-UCT307	CM-UCT307	-	13	-	152	95	2.3	-	3.2
T208	S-UCT208	SM-UCT208	C-UCT208	CM-UCT208	8	9	82	144	90	2.4	2.5	3.1
TX08	S-UCTX08	SM-UCTX08	C-UCTX08	CM-UCTX08	8	12	82	144.5	95	2.6	2.8	3.5
T308	-	-	C-UCT308	CM-UCT308	-	13	-	164	105	3	-	4.2
T209	S-UCT209	SM-UCT209	C-UCT209	CM-UCT209	8	12	82	145.5	95	2.4	2.5	3.2
TX09	S-UCTX09	SM-UCTX09	C-UCTX09	CM-UCTX09	8	12	87	152	100	2.7	3	3.7
T309	-	-	C-UCT309	CM-UCT309	-	14	-	181	110	4	-	5.5
T210	S-UCT210	SM-UCT210	C-UCT210	CM-UCT210	8	12	87	152	100	2.6	2.7	3.6
TX10	S-UCTX10	SM-UCTX10	C-UCTX10	CM-UCTX10	10	11	92	171.5	100	4.2	4.6	5.4
T310	-	-	C-UCT310	CM-UCT310	-	15	-	197	120	5	-	7.1

Cast iron take-up unit UCT type / cylindrical bore type, setscrew type

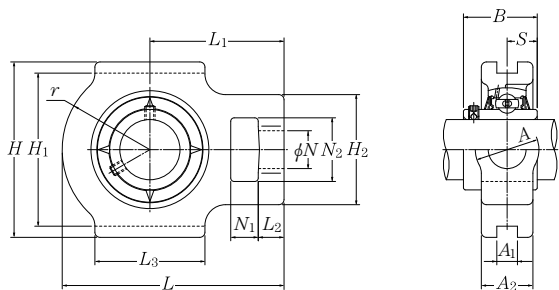

Shaft diameter: 55 to 95 mm

Shaft dia. mm	Unit number ²⁾	Dimensions mm															Number	Bearing			
		N ₁	L ₂	H ₂	N ₂	N	L ₃	A ₁	H ₁	H	L	A ₂	A	r	L ₁	B		S	C _R	C _{0R}	C _u
55	UCT211	25	21	102	64	35	95	22	130	146	171	38	64	65	106	55.6	22.2	UC211D1	48.0	29.2	2.29
	UCTX11	32	21	102	64	35	102	22	130	146	194	44	64	75	119	65.1	25.4	UCX11D1	58.0	36.0	2.83
	UCT311	29	23	105	66	39	115	22	150	163	207	44	66	80	127	66	25	UC311D1	79.5	45.0	3.50
60	UCT212	32	21	102	64	35	102	22	130	146	194	42	64	75	119	65.1	25.4	UC212D1	58.0	36.0	2.83
	UCTX12	32	23	111	70	41	121	26	151	167	224	48	70	87	137	65.1	25.4	UCX12D1	63.5	40.0	3.15
	UCT312	31	25	113	71	41	123	22	160	178	220	46	71	85	135	71	26	UC312D1	90.5	52.0	4.10
65	UCT213	32	23	111	70	41	121	26	151	167	224	44	70	87	137	65.1	25.4	UC213D1	63.5	40.0	3.15
	UCTX13	32	23	111	70	41	121	26	151	167	224	48	70	87	137	74.6	30.2	UCX13D1	69.0	44.0	3.45
	UCT313	32	27	116	70	43	134	26	170	190	238	50	80	92	146	75	30	UC313D1	103	60.0	4.60
70	UCT214	32	23	111	70	41	121	26	151	167	224	46	70	87	137	74.6	30.2	UC214D1	69.0	44.0	3.45
	UCTX14	32	23	111	70	41	121	26	151	167	232	48	70	92	140	77.8	33.3	UCX14D1	73.5	49.5	3.80
	UCT314	36	27	130	85	46	140	26	180	202	252	52	90	97	155	78	33	UC314D1	115	68.0	5.10
75	UCT215	32	23	111	70	41	121	26	151	167	232	48	70	92	140	77.8	33.3	UC215D1	73.5	49.5	3.80
	UCTX15	32	23	111	70	41	121	28	165	184	235	48	70	95	140	82.6	33.3	UCX15D1	80.5	53.0	3.95
	UCT315	36	27	132	85	46	150	26	192	216	262	55	90	102	160	82	32	UC315D1	126	77.0	5.55
80	UCT216	32	23	111	70	41	121	26	165	184	235	51	70	95	140	82.6	33.3	UC216D1	80.5	53.0	3.95
	UCTX16	38	30	124	73	48	157	28	173	198	260	54	73	98	162	85.7	34.1	UCX16D1	92.0	64.0	4.60
	UCT316	42	30	150	98	53	160	30	204	230	282	60	102	108	174	86	34	UC316D1	136	86.5	6.05
85	UCT217	38	31	124	73	48	157	30	173	198	260	54	73	98	162	85.7	34.1	UC217D1	92.0	64.0	4.60
	UCTX17	38	30	124	73	48	157	28	173	198	260	54	73	98	162	96	39.7	UCX17D1	106	71.5	5.00
	UCT317	42	32	152	98	53	170	32	214	240	298	64	102	115	183	96	40	UC317D1	147	97.0	6.55
90	UCT318	46	32	160	106	57	175	32	228	255	312	66	110	120	192	96	40	UC318D1	158	107	7.10
95	UCT319	46	33	165	106	57	180	35	240	270	322	72	110	125	197	103	41	UC319D1	169	119	7.65

1) Spherical graphite cast iron bearings are also available based on request. In this case, a supplementary suffix "N1" is added after the unit number. Example: UCT320N1

2) The unit numbers indicate the oil-free type, and supplementary suffix "D1" is added after the number for the oil feeding type.

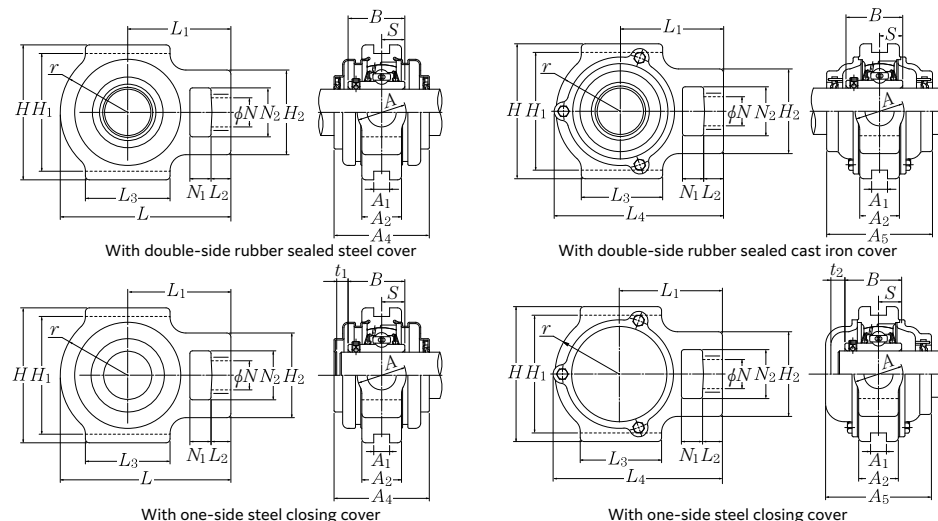

Standard housing number	Number of unit with steel cover		Number of unit with cast iron cover		Dimensions mm					Unit mass (approx.) kg		
	Double-side rubber sealed cover	One-side closing cover	Double-side rubber sealed cover	One-side closing cover	t ₁	t ₂	A ₄	L ₄	A ₅	Standard	With steel cover	With cast iron cover
T211	S-UCT211	SM-UCT211	C-UCT211	CM-UCT211	10	11	92	171.5	100	3.9	4.1	5
TX11	S-UCTX11	SM-UCTX11	C-UCTX11	CM-UCTX11	8	12	102	194	115	5.2	5.6	6.7
T311	-	-	C-UCT311	CM-UCT311	-	15	-	211	125	6.3	-	8.5
T212	S-UCT212	SM-UCT212	C-UCT212	CM-UCT212	8	12	102	194	115	4.8	5.1	6.1
TX12	S-UCTX12	SM-UCTX12	C-UCTX12	CM-UCTX12	11	15	107	224	120	7.2	7.7	9
T312	-	-	C-UCT312	CM-UCT312	-	16	-	227	135	7.6	-	10
T213	S-UCT213	SM-UCT213	C-UCT213	CM-UCT213	11	15	107	224	120	7	7.3	8.4
TX13	-	-	C-UCTX13	CM-UCTX13	-	17	-	224	135	7.4	-	9.8
T313	-	-	C-UCT313	CM-UCT313	-	19	-	244	140	9.3	-	12
T214	-	-	C-UCT214	CM-UCT214	-	17	-	224	135	7	-	9.2
TX14	-	-	C-UCTX14	CM-UCTX14	-	17	-	232	135	7.7	-	10
T314	-	-	C-UCT314	CM-UCT314	-	19	-	258	140	11	-	14
T215	-	-	C-UCT215	CM-UCT215	-	17	-	232	135	7.4	-	9.8
TX15	-	-	C-UCTX15	CM-UCTX15	-	17	-	235	145	8.3	-	11
T315	-	-	C-UCT315	CM-UCT315	-	19	-	268	150	13	-	17
T216	-	-	C-UCT216	CM-UCT216	-	17	-	235	145	8.2	-	11
TX16	-	-	C-UCTX16	CM-UCTX16	-	19	-	260	155	11	-	14
T316	-	-	C-UCT316	CM-UCT316	-	18	-	287	155	16	-	20
T217	-	-	C-UCT217	CM-UCT217	-	19	-	260	155	11	-	14
TX17	-	-	C-UCTX17	CM-UCTX17	-	20	-	262	165	11	-	15
T317	-	-	C-UCT317	CM-UCT317	-	21	-	303	170	19	-	25
T318	-	-	C-UCT318	CM-UCT318	-	21	-	317	170	21	-	27
T319	-	-	C-UCT319	CM-UCT319	-	20	-	327	180	24	-	31

Bearing Units



Cast iron take-up unit UCT type / cylindrical bore type, setscrew type

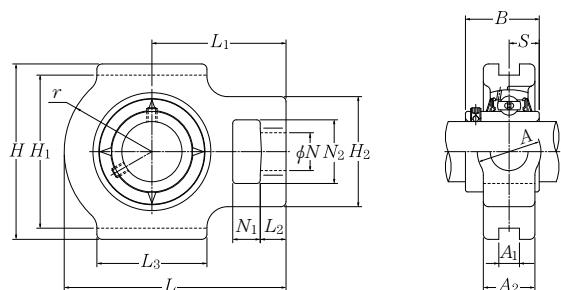

Shaft diameter: 100 to 140 mm

Shaft dia. mm	Unit number ¹⁾²⁾	Dimensions mm															Number	Bearing			
		N_1	L_2	H_2	N_2	N	L_3	A_1	H_1	H	L	A_2	A	r	L_1	B		S	C_r	Basic load ratings dynamic kN	static kN
100	UCT320	48	34	175	115	59	200	35	260	290	345	75	120	135	210	108	42	UC320D1	192	141	8.75
105	UCT321	48	34	175	115	59	200	35	260	290	347	75	120	135	212	112	44	UC321D1	204	153	9.35
110	UCT322	52	40	185	125	65	215	38	285	320	385	80	130	150	235	117	46	UC322D1	227	179	10.5
120	UCT324	60	44	210	140	70	230	45	320	355	432	90	140	165	267	126	51	UC324D1	229	185	10.5
130	UCT326	65	47	220	150	75	240	50	350	385	465	100	150	180	285	135	54	UC326D1	254	214	11.7
140	UCT328	70	52	230	160	80	255	50	380	415	515	100	155	200	315	145	59	UC328D1	280	246	13.0

Bearing Units

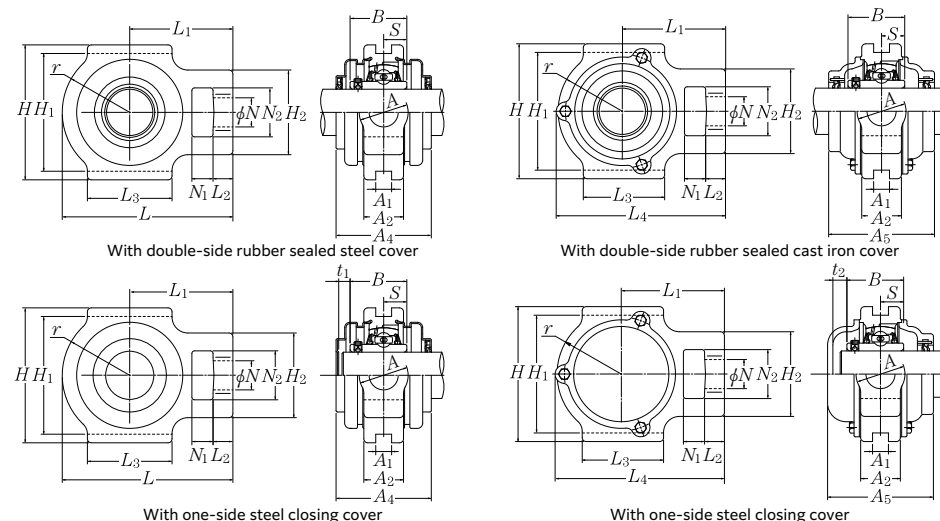

Standard housing number	Number of unit with steel cover		Number of unit with cast iron cover		Dimensions mm					Unit mass (approx.) kg		
	Double-side rubber sealed cover	One-side closing cover	Double-side rubber sealed cover	One-side closing cover	t_1	t_2	A_4	L_4	A_5	Standard	With steel cover	With cast iron cover
T320	-	-	C-UCT320	CM-UCT320	-	20	-	350	190	30	-	38
T321	-	-	C-UCT321	CM-UCT321	-	20	-	359	195	30	-	40
T322	-	-	C-UCT322	CM-UCT322	-	20	-	395	200	39	-	50
T324	-	-	C-UCT324	CM-UCT324	-	22	-	439	215	43	-	69
T326	-	-	C-UCT326	CM-UCT326	-	21	-	476	225	69	-	84
T328	-	-	C-UCT328	CM-UCT328	-	21	-	519	235	88	-	106

1) Spherical graphite cast iron bearings are also available based on request. In this case, a supplementary suffix "N1" is added after the unit number. Example: UCT320N1

2) The unit numbers indicate the oil-free type, and supplementary suffix "D1" is added after the number for the oil feeding type.

Plummer Blocks

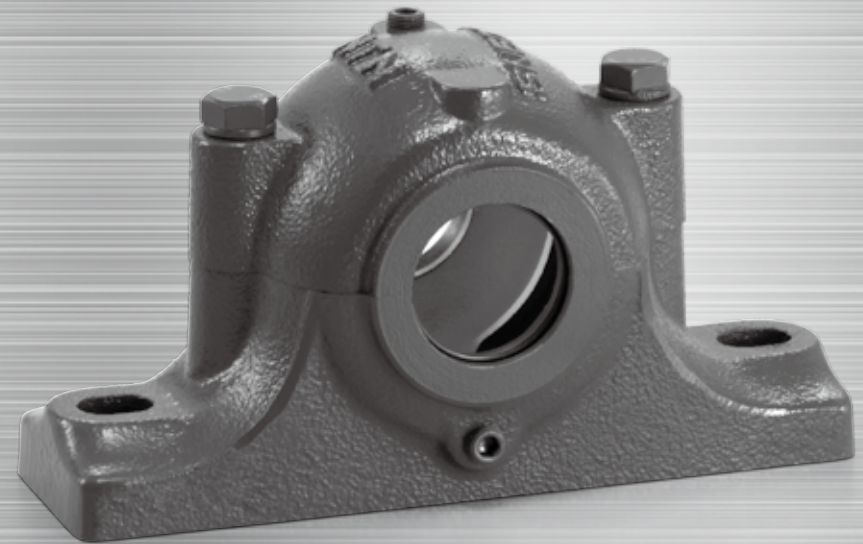

Plummer Blocks Contents

Plummer blocks	G- 2
SN5	G-14
SN2	G-16
SNZ2	G-18
SN6/S6	G-20
SN3/S3	G-22
SNZ3/SZ3	G-24
SD5/SD5G/SD6/SD6G	G-26
SD2/SD2G/SD3/SD3G	G-28
SN30/SN31	G-30
SD30/SD30G	G-32
SD31/SD31G	G-34
SV5	G-36
SV2	G-40





1. Design features and characteristics

The **NTN** plummer blocks are housings for spherical roller bearings and self-aligning ball bearings. The standard housing is gray cast iron, while spheroidal graphite cast iron (ductile cast iron) and cast steel, are also available depending on the application.



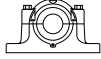





The housings can incorporate rubber seals, felt seals, or labyrinth seals depending on the application. Grease and oil are both available for lubrication.

This catalog includes dimension tables of representative shapes indicated by blue characters in "2. Plummer block types and characteristics."

For the details on **NTN** plummer blocks, see the special catalog "**Plummer blocks (CAT. No. 2500/E)**."

Plummer block types		Shaft diameter mm	Page of bearing dimension table
Split type	SN type 	25~140	G-14~25, G-30~31
	SD type 	150~300	G-26~29, G-32~35
	SBG type 	55~180	—
Single type	SV type 	20~300	G-36~43
	VA type 	50~100	—

2. Type

Type	Type
<p>SN type (standard type) SN5 SN2 SN6 SN3 S6 S3 SN30 SN31 Lubricant: grease Seal: rubber seal · SN5 and SN6 are the most general types that are specified in JIS, ISO, and DIN, and widely used in the world. · SN30 and SN31 are a medium size and can be applied when the bearing diameter is large. · A tapered bore bearing (with adapter) is used.</p> 	<p>SD type (labyrinth seal type) SD31·TS(G) SD32·TS(G) Lubricant: grease or oil Seal: Labyrinth seal · Used for heavy loads with large self-aligning roller bearings. · Suitable for high speed rotation because the sealing device for labyrinth seals is adopted. · Used for both oil lubrication and grease lubrication because an oil sump is provided in the housing.</p> 
<p>SNZ type (stepped bore type) SNZ2 SNZ3 SZ3 Lubricant: grease Seal: rubber seal · This type of plummer block is SN5, SN6, and S6 types having a large aperture on one side. · Cylindrical bore bearings are attached with nuts and washers.</p> 	<p>SV type (standard type) SV5 SV6 SV30 Lubricant: grease Seal: rubber seal · The plummer block main body is a single type and has higher accuracy compared with the divided type. · Applied to tapered bore bearings.</p> 
<p>SN type (high strength type) SN5·F SN2·F SNZ2·F SN6·F SN3·F Lubricant: grease Seal: rubber seal · The recess at the bottom part is made small to increase the strength of the plummer block. · The plummer block has same dimensions as SN5, SN6, and S6 types except the bottom shape. · A tapered bore bearing (with adapter) is used. · There is no mounting bolt hole.</p> 	<p>SV type (stepped bore type) SV2 SV3 SV35 Lubricant: grease Seal: rubber seal · This type of plummer block is SN5 and SN6 types having a large aperture on one side. · Cylindrical bore bearings are attached with nuts and washers.</p> 
<p>SD type (standard type and large bore type) SD5·(G) SD2·D(G) SD6·(G) SD3·D(G) SD30·(G) SD31·(G) SD33·(G) SD34·(G) Lubricant: grease or oil Seal: double rubber seal · Used for heavy loads with large self-aligning roller bearings. · There are types for the floating side and the fixed side (G). · A tapered bore bearing (with adapter) is used. · There are four mounting bolt holes.</p> 	<p>VA type (narrow attachment width type) VA5 Lubricant: grease Seal: oil seal · Applied to tapered bore bearings. · Mounting bolt holes are provided at the bottom.</p> 
<p>SD type (stepped bore type) SD2·(G) SD3·(G) SD35·(G) SD36·(G) Lubricant: grease or oil Seal: double rubber seal · Used for heavy loads with large self-aligning roller bearings. · This type of plummer block is SD5(G) and SD6(G) types having a large aperture on one side. · Cylindrical bore bearings are attached with nuts and washers.</p> 	

3. Plummer block numbers

A plumber block number indicates the type, structure, and consists of basic numbers followed by supplementary codes.

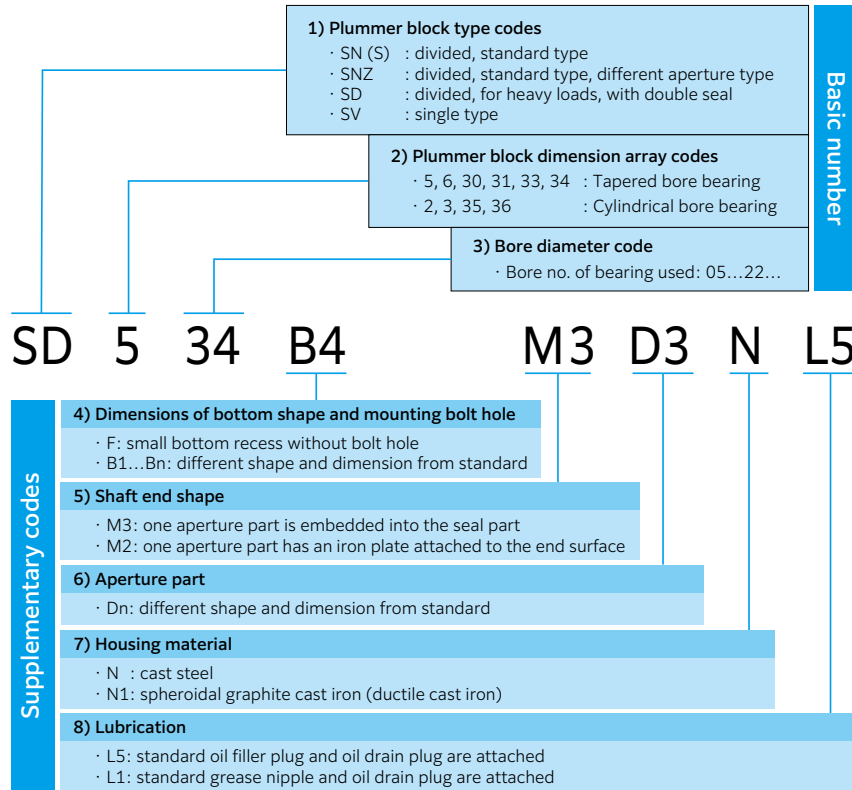

For order
The plumber block numbers do not include additional parts. Therefore, please order any necessary parts with their numbers.
(Example)

SN506	1206K	H206X	SR62×7	ZF6
Plummer blocks	Rolling bearings	Adapter	Positioning wheel (fixed side only)	Rubber seal

Article
For shaft ends, a plumber block having a non-penetrating aperture on the shaft end side (outer side) is generally used. There are two types shown below.

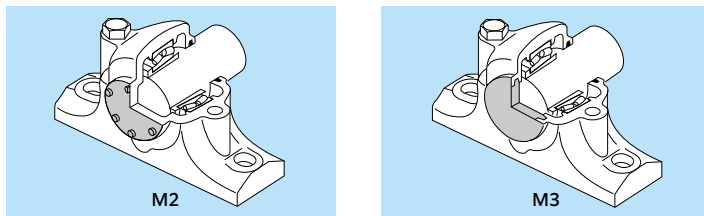

4. Accuracy

4.1 Accuracy

Regarding the accuracy of NTN plumber blocks, the divided types conform to JIS B 1551 and the single types to The Japan Bearing Industrial Association (BAS) 188. The dimensional tolerances are shown in the table below.

Table 1: dimensional tolerances of bearing seating bore diameter, width, and center height

Table 2: dimensional tolerances of length of castings (cast parts such as bases and bolt holes)

Table 1 Dimensional tolerance of plumber blocks

Unit: mm

Plummer block series	Divided type			Single type					
	Bearing seating bore dia. ΔD_s	Bearing seating bore width Δg_s	Center height ΔH_s	Plummer block series	Bearing seating bore dia. ΔD_s	Center height ΔH_s	Main body width I_1	Cover dimension I_2	Cover inlet width I_3
SN5, SN5F SN(S)6, SN(S)6F SN2, SNZ2, SN30 SN(S)3, SNZ(SZ)3, SN31 SBG5	H8	H13	h13	SV5 SV6 SV2 SV3 SV30 SV35 VA5	H7	h11	+0.2 0	±1	0 -0.2
SD30, SD31 SD33 SD34, SD35 SD36 SD2, SD3 SD5, SD6 SD31TS, SD32TS	H8	±0.2	h13						

Table 2 Dimensional tolerance of length of castings

Unit: mm

Size of castings (mm)				
120 or below	121 to 250	251 to 400	401 to 800	801 to 1600
±1.5	±2.0	±3.0	±4.0	±6.0

4.2 Machining accuracy of mounting bolt seating end surface

When a large horizontal load is to be applied on a plumber block, the fastening force of the mounting bolts cannot reliably secure the plumber block alone; therefore, the housing base should abut a fixed surface. In this case, it is effective to use a plumber block with a

machined vertical face that comes in contact with the fixed abutment surface.

Seating length L of a plumber block having a machined mounting bolt seating end surface is smaller than the standard dimension by the machining allowance shown in **Table 3** and becomes L' (see **Fig. 1**). **Table 4** shows the dimensional tolerance of L' .

Table 3 Machining allowance Unit: mm

Plummer block nominal dimension	Machining allowance $L-L'$	Surface finish roughness
All types All sizes	5	12.5Ra

Table 4 Tolerance of dimension L' after machining of mounting bolt seating end surface Unit: mm

Dimension after machining L'	31 to 120	121 to 315	316 to 1 000	1 001 to 2 000
Tolerance	±0.8	±1.2	±2.0	±3.0

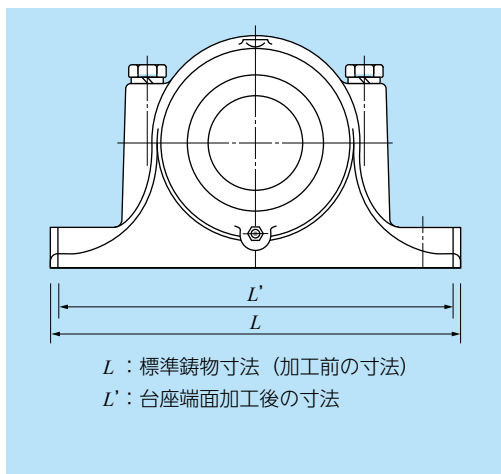

Fig. 1 Seating surface length dimension of plumber block

5. Combination with bearings

Tables 5 (1) and (2) show the combinations of plumber blocks and bearings.

Table 5 (1) Plummer blocks and applied bearings

Applied bearing series / Plummer block series	12	22	13	23	230	231	222	232	213	223
SN5 SN5··F	06SK ~22SK	06SK ~22SK					06EAK ~32EAK	18EMK, 20EMK ~32EMK		
SN2 SN2··F	06S ~22S	06S ~22S					06EA ~32EA	18EM, 20EM ~32EM		
SNZ2 SNZ2··F	06S ~22S	06S ~22S					06EA ~32EA	18EM, 20EM ~32EM		
SD5 SD5··G							34EMK ~64EMK			
SD2··D SD2··DG							34EM ~64EM			
SD2 SD2··G							34EM ~64EM			
SN(S)6 SN(S)6··F			06SK ~22SK	06SK ~22SK					08CK~10CK 11K~22K	08EAK~28EAK 30EMK~32EMK
SN(S)3 SN(S)3··F			06S ~22S	06S ~22S					08C~10C 11~22	08EA~28EA 30EM~32EM
SNZ(SZ)3 SNZ(SZ)3··F			06S ~22S	06S ~22S					08C~10C 11~22	08EA~28EA 30EM~32EM
SD6 SD6··G										34EMK ~56EMK
SD3··D SD3··DG										34EM ~56EM
SD3 SD3··G										34EM ~56EM
SN30						24EAK ~38EAK				
SD30 SD30··G						34EAK ~38EAK				
SD33 SD33··G						40EMK ~76EMK				
SD35 SD35··G						40EM ~76EM				
SN31							22EAK~36EAK 38EMK			
SD31 SD31··G							34EAK~36EAK 38EMK~68EMK 72BK~84BK			
SD34 SD34··G							40EMK ~68EMK			
SD36 SD36··G							40EM ~68EM			

Table 5 (2) Plummer blocks and applied bearings

Applied bearing series Plummer block series	12	22	13	23	230	231	222	232	213	223
SD31··TS SD31··TSG						34EAK~36EAK 38EMK~68EMK 72BK~89BK				
SD32··TS SD32··TSG							34EMK~64EMK 68BK~80BK			
SBG5							12EAK~32EAK 34EMK~40EMK			
SV5	05SK ~22SK	05SK ~22SK					05EAK ~32EAK	18EMK, 20EMK~64EMK		
SV2	05S ~22S	05S ~22S					05EA~32EA	18EM, 20EM~38EM		
SV6			05SK ~22SK	05SK ~22SK				08CK~10CK 11K~22K	08EA~28EA 30EM~58EM	
SV3			05S ~22S	05S ~22S				08C~10C 11~22	08EA~28EA 30EM~58EM	
SV30					22EAK~38EAK 40EMK~72EMK					
SV35					22EA~38EA 40EM~72EM					
VA5							11EAK ~22EAK			
TV5							11EAK ~32EAK			

6. Allowable speed

The allowable speed of plummer blocks differ by seal types. In the case of a contact seal, the allowable speed is restricted by the allowable

peripheral speed of the seal. Fig. 2 shows a rough standard for selecting the peripheral speed of seals.

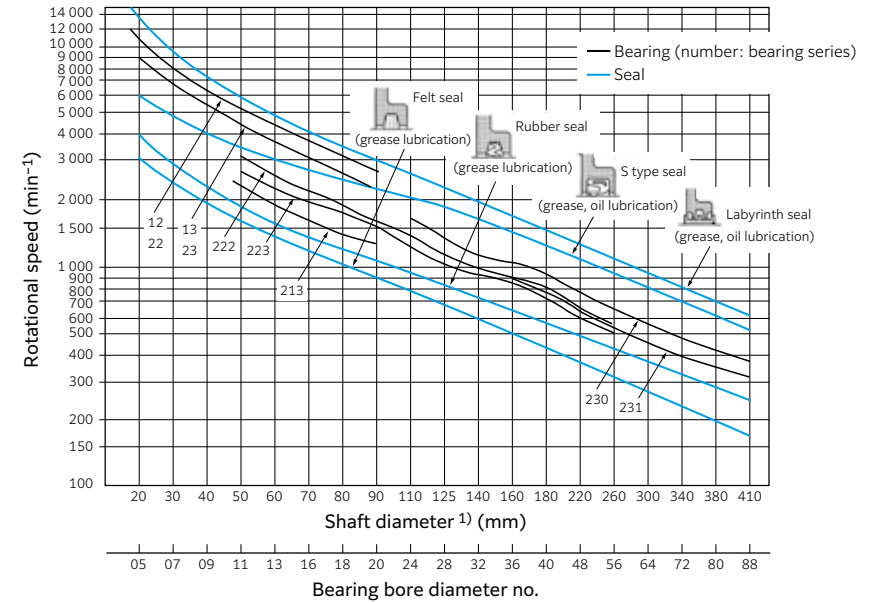

1) The allowable speed of the seal of cylindrical bore bearings is obtained by the shaft diameter of the seal contact part. The allowable speed of seals is indicated by the rotational speed of shafts.

Fig. 2 Allowable speed of bearings and seals

7. Sealing device

External seals have two main functions: to prevent lubrication from leaking out and to prevent dust, water, and other contaminants from entering the bearing.

The sealing device must be selected with the following in consideration: the type of lubricant (oil or grease) and seal peripheral speed.

A rubber seal or a felt seal is used for the contact type, and a labyrinth seal is used for the non-contact type. There are also special seals suitable for other conditions including heavy contamination.

7.1 Contact seal

(1) Rubber seal (Fig. 3)

Since rubber seals are mainly used for grease lubrication, a rough standard for the peripheral speed is 5 to 6 m/s.

Nitrile rubber is generally used for the rubber seal material, and materials shown in **Table 6** are used depending on the ambient temperature.

(2) Felt seal (Fig. 4)

Felt seals are interchangeable with rubber seals, but the use is limited to grease lubrication.

Felt seals are unsuitable for environments with a large amount of dust or high humidity, and a rough standard for the peripheral speed is 4 m/s. The seal is also convenient because it can be cut and embedded separately into the seal grooves at the upper and lower parts of a plummer block.

(3) S type seal (Fig. 5)

The S type seal has excellent sealing performance and can be used for grease and oil lubrications. Plummer blocks with special specifications are used.

A rough standard for the peripheral speed of S type seals is 10 to 12 m/s. The shaft roughness and hardness of the seal contact area especially needs attention.

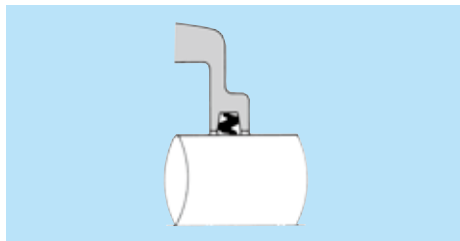

Fig. 3 Rubber seal

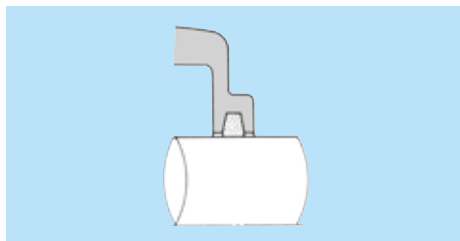

Fig. 4 Felt seal

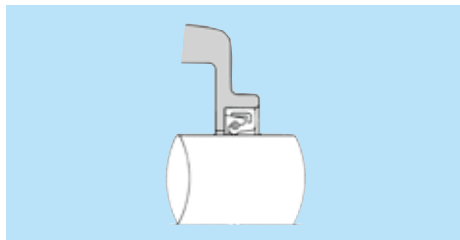

Fig. 5 S type seal

Table 6 Rubber seal types and characteristics

Seal material	Abrasion resistance	Oil resistance	Acid resistance	Alkali resistance	Water resistance	Allowable temp rough standard (°C)	Characteristics
Nitrile rubber (NBR)	◎	◎	○	○	○	-25 100	The material has resistance to most oils and has good abrasion resistance; therefore, it is the most used oil seal material. The material can be used for most conditions of general machines.
Acrylic rubber (ACM)	◎	◎	△	×	△	-15 130	The material has good heat resistance and oil resistance but poor alkali resistance and water resistance; therefore, the application is limited.
Silicone rubber (VMQ)	○	○	△	×	○	-50 220	The material has good heat resistance and cold resistance but cannot be used for spindle oil and oil containing an extreme pressure additive.
Fluorinated rubber (FKM)	◎	◎	◎	△	○	-10 220	The material is not affected by most oils and chemicals. The material has well-balanced characteristics and can be used in a wide range of applications; therefore, it is the best oil seal material.

◎ : Good, ○ : Fair, △ : Slightly poor, × : Poor (cannot be used)

7.2 Non-contact seal

(1) Labyrinth seal (Fig. 6)

The labyrinth seal is a seal type that uses a labyrinth ring at the aperture part of a plummer block.

The labyrinth ring is used with a shaft loose fit (h9) and attached with an O ring to allow easy attachment and allow for expansion and contraction of the shaft.

The labyrinth seal has excellent sealing performance and can be used for grease and oil lubrications.

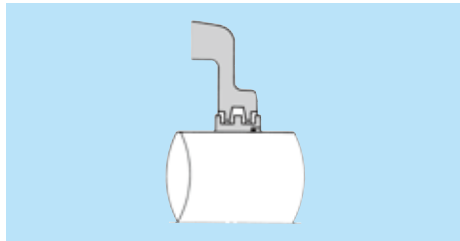

Fig. 6 Labyrinth seal

(2) Special labyrinth seal (Fig. 7)

The special labyrinth seal shown in the figure is especially effective for environments with a large amount of contamination such as dirt and sand.

Plummer blocks using this seal have special specifications, so consult with NTN Engineering.

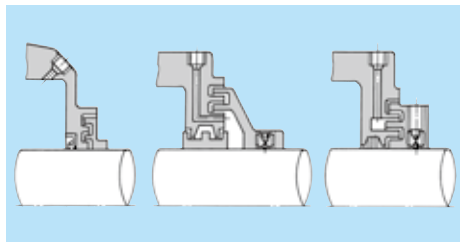

Fig. 7 Special labyrinth seal

(3) Shaft design criteria for seal attachment part (Table 7)

The hardness and roughness of shafts to be attached with seal significantly influences the sealing performance; therefore, the design criteria shown in the table must be followed.

Table 7 Shaft design criteria

Item	Design criteria	Article
Hardness	30 to 40 HRC	
Roughness <i>Ra</i>	0.8	It is preferable to grind the finish surface without feeding.
End surface chamfer	The shaft end to be inserted with a seal must be tapered, and the corner part must be rounded.	15~30° Round the corner.

7.3 Combination seal (Fig. 8)

The combination seal is a sealing device having a rubber seal and a labyrinth seal combined to the aperture part of a plummer block. It is used for environments with a large amount of dirt and foreign materials.

Filling the labyrinth voids with grease further improves the sealing effect.

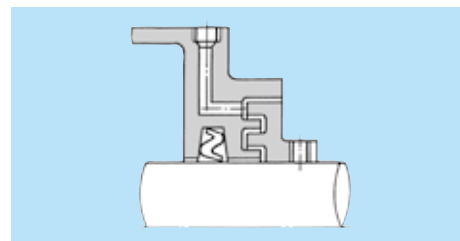

Fig. 8 Combination seal

8. Strength

The breaking strength of plummer blocks differ by the plummer block type, the characteristic and direction of the load to be applied, and is influenced by the flatness of the mounting surfaces. Fig. 9 and Fig. 10 shows the general fracture loads of static breaking strength of SN5 and SN6 (S6) series gray cast iron plummer blocks.

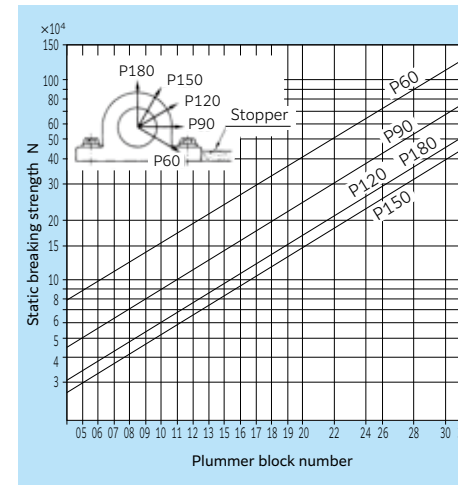

Fig. 9 Static breaking strength of SN5 series

The downward breaking strength is about twice the horizontal breaking strength, and the axial breaking strength is about half of the horizontal breaking strength.

When selecting plummer blocks, consider the safety factor shown in Table 8. The surface to be attached with a plummer block must be flat without backlash.

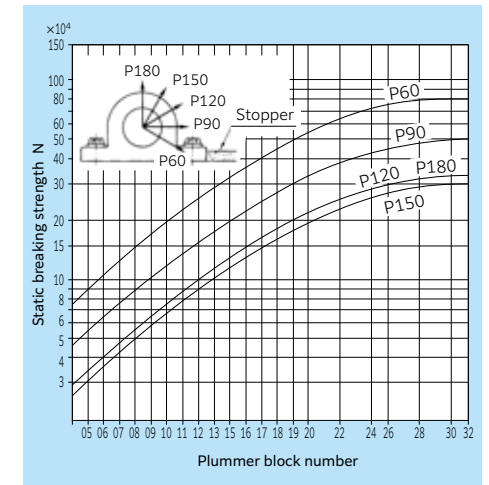

Fig. 10 Static breaking strength of SN6 series

Table 8 Safety factor of casting plummer block

Types of load	Static load	Repeated load	Alternating load	Impact load
Safety factor	4	6	10	15

For horizontal and axial loads, the base end surface needs to abut a fixed surface.

For places with especially large impact loads or when plummer block damage may result in serious accidents, plummer blocks made of materials other than gray cast iron such as cast steel or spheroidal graphite cast iron are available. Please consult NTN Engineering.

Plummer Blocks



Plummer block series SN5
(standard type / for bearings with adapter assembly)

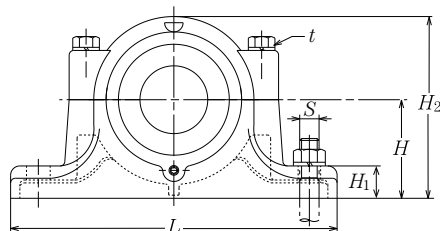
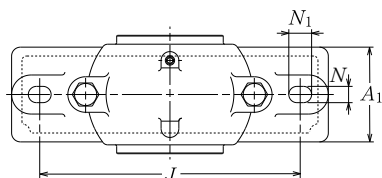

d_1 25 ~ 140mm

Shaft dia. mm	Plummer block number	Dimensions										Oil filler / drain plug size	Reference dimension S	Mass kg		
		mm														
d_1		D	H	J	N	N ₁	A	L	A ₁	H ₁	H ₂	g	t	S	(approx.)	
25	SN506	62	50	150	15	20	77	185	52	22	90	30	M8	R1/8	M12	1.7
30	SN507	72	50	150	15	20	82	185	52	22	95	33	M10	R1/8	M12	2.2
35	SN508	80	60	170	15	20	85	205	60	25	110	33	M10	R1/8	M12	2.6
40	SN509	85	60	170	15	20	85	205	60	25	112	31	M10	R1/8	M12	2.8
45	SN510	90	60	170	15	20	90	205	60	25	115	33	M10	R1/8	M12	3
50	SN511	100	70	210	18	23	95	255	70	28	130	33	M12	R1/8	M16	4
55	SN512	110	70	210	18	23	105	255	70	30	135	38	M12	R1/8	M16	4.5
60	SN513	120	80	230	18	23	110	275	80	30	150	43	M12	R1/8	M16	5.6
65	SN515	130	80	230	18	23	115	280	80	30	155	41	M12	R1/8	M16	6
70	SN516	140	95	260	22	27	120	315	90	32	175	43	M16	R1/8	M20	9
75	SN517	150	95	260	22	27	125	320	90	32	185	46	M16	R1/8	M20	9.3
80	SN518	160	100	290	22	27	145	345	100	35	195	62.4	M16	R1/8	M20	12
85	SN519	170	112	290	22	27	140	345	100	35	210	53	M16	R1/8	M20	14
90	SN520	180	112	320	26	32	160	380	110	40	218	70.3	M20	R1/8	M24	17
100	SN522	200	125	350	26	32	175	410	120	45	240	80	M20	R1/4	M24	20
110	SN524	215	140	350	26	32	185	410	120	45	270	86	M20	R1/4	M24	23
115	SN526	230	150	380	28	36	190	445	130	50	290	90	M24	R1/4	M24	29
125	SN528	250	150	420	33	42	205	500	150	50	305	98	M24	R1/4	M30	37
135	SN530	270	160	450	33	42	220	530	160	60	325	106	M24	R1/4	M30	42
140	SN532	290	170	470	33	42	235	550	160	60	345	114	M24	R1/4	M30	48

1) The stabilizing ring indicates the outer diameter and width dimension.
2) Dimension Y indicates the reference dimension from the shaft center to the end in the case of the shaft end shape.
Note: 1. SN524 or larger plummer blocks are provided with a lifting eye bolt.

Plummer Blocks

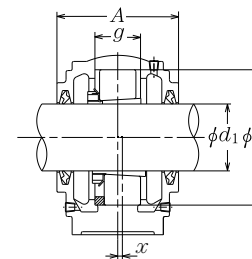

Shaft penetration type

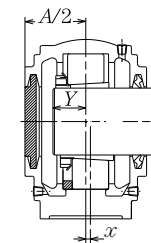

Shaft end type

Combination of self-aligning ball bearings	Applied part		Reference dimension mm	Rubber seal number	End cover number	Shaft dia. mm
	Bearing number	Adapter number				
1206SK	H206X	SR62×7	2	—	—	18
2206SK	H306X	SR62×10	1	22206EAKW33	H306X	20
1207SK	H207X	SR72×8	2	—	—	19
2207SK	H307X	SR72×10	1	22207EAKW33	H307X	22
1208SK	H208X	SR80×7.5	2	—	—	21
2208SK	H308X	SR80×10	1	22208EAKD1	H308X	23
1209SK	H209X	SR85×6	2	—	—	22
2209SK	H309X	SR85×8	1	22209EAKD1	H309X	24
1210SK	H210X	SR90×6.5	2	—	—	24
2210SK	H310X	SR90×10	1	22210EAKD1	H310X	25
1211SK	H211X	SR100×6	2	—	—	25
2211SK	H311X	SR100×8	1	22211EAKD1	H311X	27
1212SK	H212X	SR110×8	2	—	—	26
2212SK	H312X	SR110×10	1	22212EAKD1	H312X	29
1213SK	H213X	SR120×10	2	—	—	28
2213SK	H313X	SR120×12	1	22213EAKD1	H313X	32
1215SK	H215X	SR130×8	2	—	—	30
2215SK	H315X	SR130×10	1	22215EAKD1	H315X	33
1216SK	H216X	SR140×8.5	2	—	—	32
2216SK	H316X	SR140×10	1	22216EAKD1	H316X	36
1217SK	H217X	SR150×9	2	—	—	34
2217SK	H317X	SR150×10	1	22217EAKD1	H317X	38
1218SK	H218X	SR160×16.2	2	—	—	35
2218SK	H318X	SR160×11.2	2	22218EAKD1	H318X	40
—	—	—	—	23218EMKD1	H2318X	46
1219SK	H219X	SR170×10.5	2	—	—	37
2219SK	H319X	SR170×10	1	22219EAKD1	H319X	43
1220SK	H220X	SR180×18.1	2	—	—	39
2220SK	H320X	SR180×12.1	2	22220EAKD1	H320X	45
—	—	—	—	23220EMKD1	H2320X	52
1222SK	H222X	SR200×21	2	—	—	42
2222SK	H322X	SR200×13.5	2	22222EAKD1	H322X	50
—	—	—	—	23222EMKD1	H2322X	58
—	—	—	—	22224EAKD1	H3124X	53
—	—	—	—	23224EMKD1	H2324X	62
—	—	—	—	22226EAKD1	H3126	57
—	—	—	—	23226EMKD1	H2326	65
—	—	—	—	22228EAKD1	H3128	60
—	—	—	—	23228EMKD1	H2328	70
—	—	—	—	22230EAKD1	H3130	65
—	—	—	—	23230EMKD1	H2330	76
—	—	—	—	22232EAKD1	H3132	71
—	—	—	—	23232EMKD1	H2332	83

Note: 2. Dimension x applies to plummer block numbers using one stabilizing ring and indicates the value of deviation from the bearing center to the plummer block center. The value is 1/2 of the width dimension of the stabilizing ring.
3. Adapters for series 12 bearings can also be used with H2 and H3 series bearings.

Plummer Blocks



Plummer block series SN2
(large bore type / for cylindrical bore bearings)

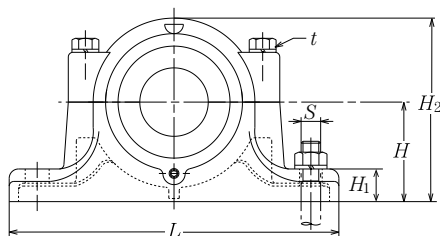
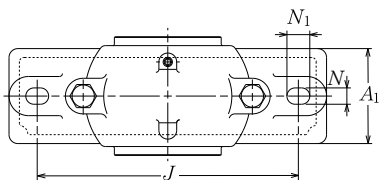

d 30 ~ 160mm

Shaft diameter mm	Plummer block number	Dimensions											Oil filler / drain plug size	Reference dimension S	Mass kg		
		mm															
d	d ₂	D	H	J	N	N ₁	A	L	A ₁	H ₁	H ₂	g	t	Nominal no.	S	Nominal dimension (approx.)	
30	35	SN206	62	50	150	15	20	77	185	52	22	90	30	M8	R1/8	M12	1.7
35	45	SN207	72	50	150	15	20	82	185	52	22	95	33	M10	R1/8	M12	2.1
40	50	SN208	80	60	170	15	20	85	205	60	25	110	33	M10	R1/8	M12	2.7
45	55	SN209	85	60	170	15	20	85	205	60	25	112	31	M10	R1/8	M12	3
50	60	SN210	90	60	170	15	20	90	205	60	25	115	33	M10	R1/8	M12	3.2
55	65	SN211	100	70	210	18	23	95	255	70	28	130	33	M12	R1/8	M16	4.3
60	70	SN212	110	70	210	18	23	105	255	70	30	135	38	M12	R1/8	M16	5.2
65	75	SN213	120	80	230	18	23	110	275	80	30	150	43	M12	R1/8	M16	5.9
70	80	SN214	125	80	230	18	23	115	275	80	30	155	44	M12	R1/8	M16	5.7
75	85	SN215	130	80	230	18	23	115	280	80	30	155	41	M12	R1/8	M16	7.2
80	90	SN216	140	95	260	22	27	120	315	90	32	175	43	M16	R1/8	M20	8.9
85	95	SN217	150	95	260	22	27	125	320	90	32	185	46	M16	R1/8	M20	9.9
90	100	SN218	160	100	290	22	27	145	345	100	35	195	62.4	M16	R1/8	M20	12
95	110	SN219	170	112	290	22	27	140	345	100	35	210	53	M16	R1/8	M20	13
100	115	SN220	180	112	320	26	32	160	380	110	40	218	70.3	M20	R1/8	M24	17
110	125	SN222	200	125	350	26	32	175	410	120	45	240	80	M20	R1/4	M24	22
120	135	SN224	215	140	350	26	32	185	410	120	45	270	86	M20	R1/4	M24	23
130	145	SN226	230	150	380	28	36	190	445	130	50	290	90	M24	R1/4	M24	28
140	155	SN228	250	150	420	33	42	205	500	150	50	305	98	M24	R1/4	M30	36
150	165	SN230	270	160	450	33	42	220	530	160	60	325	106	M24	R1/4	M30	43
160	175	SN232	290	170	470	33	42	235	550	160	60	345	114	M24	R1/4	M30	50

1) The stabilizing ring indicates the outer diameter and width dimension. 2) Dimension Y indicates the reference dimension from the shaft center to the end in the case of the shaft end shape. Note: 1. SN224 or larger plummer blocks are provided with a lifting eye bolt.

Plummer Blocks

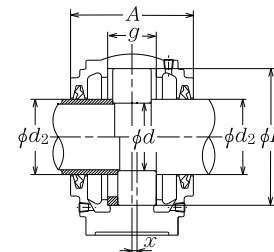

Shaft penetration type

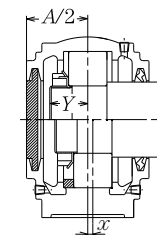

Shaft end type

Combination of self-aligning ball bearings	Applied part		Reference dimension mm	Rubber seal number	End cover number	Shaft dia. mm	
	Bearing number	Stabilizing ring Number 1)					Quantity
1206S	SR62×7	2	—	—	—	18	
2206S	SR62×10	1	22206EAW33	SR62×10	1	20	
1207S	SR72×8	2	—	—	—	19	
2207S	SR72×10	1	22207EAW33	SR72×10	1	22	
1208S	SR80×7.5	2	—	—	—	21	
2208S	SR80×10	1	22208EAD1	SR80×10	1	23	
1209S	SR85×6	2	—	—	—	22	
2209S	SR85×8	1	22209EAD1	SR85×8	1	24	
1210S	SR90×6.5	2	—	—	—	24	
2210S	SR90×10	1	22210EAD1	SR90×10	1	25	
1211S	SR100×6	2	—	—	—	25	
2211S	SR100×8	1	22211EAD1	SR100×8	1	27	
1212S	SR110×8	2	—	—	—	26	
2212S	SR110×10	1	22212EAD1	SR110×10	1	29	
1213S	SR120×10	2	—	—	—	28	
2213S	SR120×12	1	22213EAD1	SR120×12	1	32	
1214S	SR125×10	2	—	—	—	28	
2214S	SR125×13	1	22214EAD1	SR125×13	1	32	
1215S	SR130×8	2	—	—	—	30	
2215S	SR130×10	1	22215EAD1	SR130×10	1	33	
1216S	SR140×8.5	2	—	—	—	32	
2216S	SR140×10	1	22216EAD1	SR140×10	1	36	
1217S	SR150×9	2	—	—	—	34	
2217S	SR150×10	1	22217EAD1	SR150×10	1	38	
1218S	SR160×16.2	2	—	—	—	35	
2218S	SR160×11.2	2	22218EAD1	SR160×11.2	2	40	
—	—	—	23218EMD1	SR160×10	1	46	
1219S	SR170×10.5	2	—	—	—	37	
2219S	SR170×10	1	22219EAD1	SR170×10	1	43	
1220S	SR180×18.1	2	—	—	—	39	
2220S	SR180×12.1	2	22220EAD1	SR180×12.1	2	45	
—	—	—	23220EMD1	SR180×10	1	52	
1222S	SR200×21	2	—	—	—	42	
2222S	SR200×13.5	2	22222EAD1	SR200×13.5	2	50	
—	—	—	23222EMD1	SR200×10	1	58	
—	—	—	22224EAD1	SR215×14	2	53	
—	—	—	23224EMD1	SR215×10	1	62	
—	—	—	22226EAD1	SR230×13	2	57	
—	—	—	23226EMD1	SR230×10	1	65	
—	—	—	22228EAD1	SR250×15	2	60	
—	—	—	23228EMD1	SR250×10	1	70	
—	—	—	22230EAD1	SR270×16.5	2	65	
—	—	—	23230EMD1	SR270×10	1	75	
—	—	—	22232EAD1	SR290×17	2	71	
—	—	—	23232EMD1	SR290×10	1	83	

Note: 2. Dimension x applies to plummer block numbers using one stabilizing ring and indicates the value of deviation from the bearing center to the plummer block center. The value is 1/2 of the width dimension of the stabilizing ring.

Plummer Blocks



Plummer block series SNZ2
(stepped bore type / for cylindrical bore bearings)

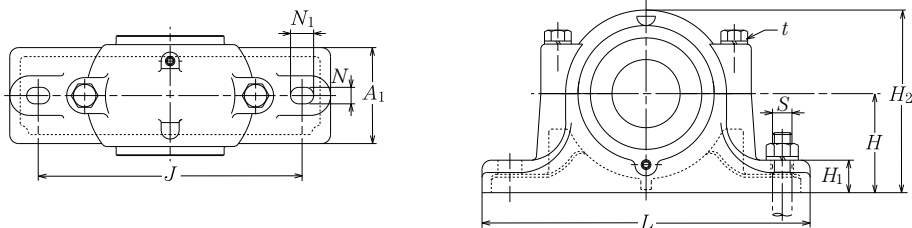

d 30 ~ 160mm

d	Shaft diameter mm		Plummer block number	Dimensions mm											Oil filler / drain plug size	Reference dimension S Nominal dimension	Mass kg (approx.)	
	d ₁	d ₂		D	H	J	N	N ₁	A	L	A ₁	H ₁	H ₂	g				t
30	25	35	SNZ206	62	50	150	15	20	77	185	52	22	90	30	M 8	R1/8	M12	1.8
35	30	45	SNZ207	72	50	150	15	20	82	185	52	22	95	33	M10	R1/8	M12	2.2
40	35	50	SNZ208	80	60	170	15	20	85	205	60	25	110	33	M10	R1/8	M12	2.9
45	40	55	SNZ209	85	60	170	15	20	85	205	60	25	112	31	M10	R1/8	M12	3.2
50	45	60	SNZ210	90	60	170	15	20	90	205	60	25	115	33	M10	R1/8	M12	3.4
55	50	65	SNZ211	100	70	210	18	23	95	255	70	28	130	33	M12	R1/8	M16	4.5
60	55	70	SNZ212	110	70	210	18	23	105	255	70	30	135	38	M12	R1/8	M16	5.4
65	60	75	SNZ213	120	80	230	18	23	110	275	80	30	150	43	M12	R1/8	M16	6.2
70	60	80	SNZ214	125	80	230	18	23	115	275	80	30	155	44	M12	R1/8	M16	6.7
75	65	85	SNZ215	130	80	230	18	23	115	280	80	30	155	41	M12	R1/8	M16	7.6
80	70	90	SNZ216	140	95	260	22	27	120	315	90	32	175	43	M16	R1/8	M20	9.4
85	75	95	SNZ217	150	95	260	22	27	125	320	90	32	185	46	M16	R1/8	M20	10
90	80	100	SNZ218	160	100	290	22	27	145	345	100	35	195	62.4	M16	R1/8	M20	13
95	85	110	SNZ219	170	112	290	22	27	140	345	100	35	210	53	M16	R1/8	M20	16
100	90	115	SNZ220	180	112	320	26	32	160	380	110	40	218	70.3	M20	R1/8	M24	18
110	100	125	SNZ222	200	125	350	26	32	175	410	120	45	240	80	M20	R1/4	M24	23
120	110	135	SNZ224	215	140	350	26	32	185	410	120	45	270	86	M20	R1/4	M24	25
130	115	145	SNZ226	230	150	380	28	36	190	445	130	50	290	90	M24	R1/4	M24	32
140	125	155	SNZ228	250	150	420	33	42	205	500	150	50	305	98	M24	R1/4	M30	41
150	135	165	SNZ230	270	160	450	33	42	220	530	160	60	325	106	M24	R1/4	M30	49
160	140	175	SNZ232	290	170	470	33	42	235	550	160	60	345	114	M24	R1/4	M30	57

1) The stabilizing ring indicates the outer diameter and width dimension. 2) Dimension Y indicates the reference dimension from the shaft center to the end in the case of the shaft end shape. Note: 1. SNZ224 or larger plummer blocks are provided with a lifting eye bolt.

Plummer Blocks

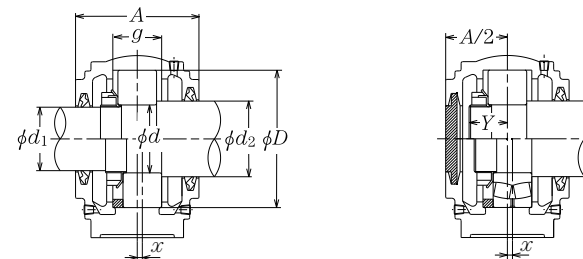

Shaft penetration type

Shaft end type

Combination of self-aligning ball bearings Bearing number	Applied part		Nut number	Washer number	Reference dimension mm Y ²⁾	Rubber seal number		End cover number	Shaft dia. mm d
	Stabilizing ring Number ¹⁾	Quantity				Combination of spherical roller bearings Bearing number	Stabilizing ring Number ¹⁾		
1206S	SR62×7	2	-	-	-	-	-	-	30
2206S	SR62×10	1	22206EAW33	SR62×10	1	AN06	AW06X	18 20	30
1207S	SR72×8	2	-	-	-	-	-	-	35
2207S	SR72×10	1	22207EAW33	SR72×10	1	AN07	AW07X	19 22	35
1208S	SR80×7.5	2	-	-	-	-	-	-	40
2208S	SR80×10	1	22208EAD1	SR80×10	1	AN08	AW08X	21 23	40
1209S	SR85×6	2	-	-	-	-	-	-	45
2209S	SR85×8	1	22209EAD1	SR85×8	1	AN09	AW09X	22 24	45
1210S	SR90×6.5	2	-	-	-	-	-	-	50
2210S	SR90×10	1	22210EAD1	SR90×10	1	AN10	AW10X	24 25	50
1211S	SR100×6	2	-	-	-	-	-	-	55
2211S	SR100×8	1	22211EAD1	SR100×8	1	AN11	AW11X	25 27	55
1212S	SR110×8	2	-	-	-	-	-	-	60
2212S	SR110×10	1	22212EAD1	SR110×10	1	AN12	AW12X	26 29	60
1213S	SR120×10	2	-	-	-	-	-	-	65
2213S	SR120×12	1	22213EAD1	SR120×12	1	AN13	AW13X	28 32	65
1214S	SR125×10	2	-	-	-	-	-	-	70
2214S	SR125×13	1	22214EAD1	SR125×13	1	AN14	AW14X	28 32	70
1215S	SR130×8	2	-	-	-	-	-	-	75
2215S	SR130×10	1	22215EAD1	SR130×10	1	AN15	AW15X	30 33	75
1216S	SR140×8.5	2	-	-	-	-	-	-	80
2216S	SR140×10	1	22216EAD1	SR140×10	1	AN16	AW16X	32 36	80
1217S	SR150×9	2	-	-	-	-	-	-	85
2217S	SR150×10	1	22217EAD1	SR150×10	1	AN17	AW17X	34 38	85
1218S	SR160×16.2	2	-	-	-	-	-	-	90
2218S	SR160×11.2	2	23218EAD1	SR160×11.2	2	AN18	AW18X	40 46	90
-	-	-	23218EMD1	SR160×10	1	-	-	-	-
1219S	SR170×10.5	2	-	-	-	-	-	-	95
2219S	SR170×10	1	22219EAD1	SR170×10	1	AN19	AW19X	37 43	95
1220S	SR180×18.1	2	-	-	-	-	-	-	100
2220S	SR180×12.1	2	22220EAD1	SR180×12.1	2	AN20	AW20X	45 52	100
-	-	-	23220EMD1	SR180×10	1	-	-	-	-
1222S	SR200×21	2	-	-	-	-	-	-	110
2222S	SR200×13.5	2	22222EAD1	SR200×13.5	2	AN22	AW22X	50 58	110
-	-	-	23222EMD1	SR200×10	1	-	-	-	-
-	-	-	22224EAD1	SR215×14	2	AN24	AW24X	53 62	120
-	-	-	23224EMD1	SR215×10	1	-	-	-	-
-	-	-	22226EAD1	SR230×13	2	AN26	AW26	57 65	130
-	-	-	23226EMD1	SR230×10	1	-	-	-	-
-	-	-	22228EAD1	SR250×15	2	AN28	AW28	60 70	140
-	-	-	23228EMD1	SR250×10	1	-	-	-	-
-	-	-	22230EAD1	SR270×16.5	2	AN30	AW30	65 76	150
-	-	-	23230EMD1	SR270×10	1	-	-	-	-
-	-	-	22232EAD1	SR290×17	2	AN32	AW32	71 83	160
-	-	-	23232EMD1	SR290×10	1	-	-	-	-

Note: 2. Dimension x applies to plummer block numbers using one stabilizing ring and indicates the value of deviation from the bearing center to the plummer block center. The value is 1/2 of the width dimension of the stabilizing ring.

Plummer Blocks



Plummer block series SN6 / S6
(standard type / for bearings with adapter)

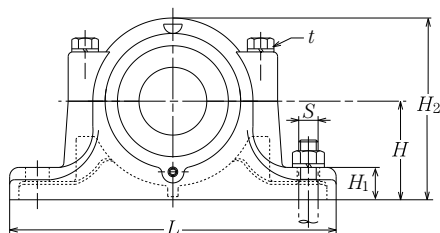
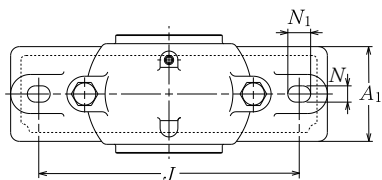

d_1 25 ~ 140mm

Shaft dia. mm	Plummer block number	Dimensions											Oil filler / drain plug size	Reference dimension S	Mass kg	
		mm														
d_1	D	H	J	N	N_1	A	L	A_1	H_1	H_2	g	t	Nominal no.	S	(approx.)	
25	SN606	72	50	150	15	20	82	185	52	22	95	37	M10	R1/8	M12	2.3
30	SN607	80	60	170	15	20	90	205	60	25	110	41	M10	R1/8	M12	3
35	SN608	90	60	170	15	20	95	205	60	25	115	43	M10	R1/8	M12	3.1
40	SN609	100	70	210	18	23	105	255	70	28	130	46	M12	R1/8	M16	4.4
45	SN610	110	70	210	18	23	115	255	70	30	135	50	M12	R1/8	M16	5
50	SN611	120	80	230	18	23	120	275	80	30	150	53	M12	R1/8	M16	5.8
55	SN612	130	80	230	18	23	125	280	80	30	155	56	M12	R1/8	M16	7.7
60	SN613	140	95	260	22	27	130	315	90	32	175	58	M16	R1/8	M20	9.8
65	SN615	160	100	290	22	27	140	345	100	35	195	65	M16	R1/8	M20	12
70	SN616	170	112	290	22	27	145	345	100	35	212	68	M16	R1/8	M20	15
75	SN617	180	112	320	26	32	155	380	110	40	218	70	M20	R1/8	M24	17
80	S618	190	112	320	26	35	160	400	110	33	230	74	M20	R1/4	M24	21
85	S619	200	125	350	26	35	170	420	120	36	245	77	M20	R1/4	M24	24
90	S620	215	140	350	26	35	175	420	120	38	280	83	M20	R1/4	M24	29
100	S622	240	150	390	28	38	190	460	130	40	300	90	M24	R1/4	M24	38
110	S624	260	160	450	33	42	205	540	160	50	325	96	M24	R1/4	M30	47
115	S626	280	170	470	33	42	215	560	160	50	350	103	M24	R1/4	M30	54
125	S628	300	180	520	35	45	235	630	170	55	375	112	M30	R1/4	M30	70
135	S630	320	190	560	35	45	245	680	180	55	395	118	M30	R1/4	M30	75
140	S632	340	200	580	42	52	255	710	190	60	415	124	M30	R1/4	M36	80

1) The stabilizing ring indicates the outer diameter and width dimension. 2) Dimension Y indicates the reference dimension from the shaft center to the end in the case of the shaft end shape. Note: 1. S618 or larger plummer blocks are provided with a lifting eye bolt.

Plummer Blocks

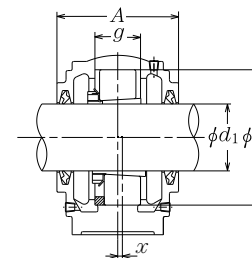

Shaft penetration type

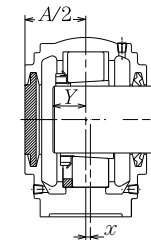

Shaft end type

Applied part								Reference dimension mm	Rubber seal number	End cover number	Shaft dia. mm
Combination of self-aligning ball bearings	Adapter	Stabilizing ring	Bearing	Adapter	Stabilizing ring	Reference dimension	Quantity				
Bearing number	Adapter number	Number 1)	Quantity	Bearing number	Adapter number	Number 1)	Quantity	Y 2)			d_1
1306SK	H306X	SR72×9	2					19	ZF6	MF6	25
2306SK	H2306X	SR72×10	1					23			
1307SK	H307X	SR80×10	2					26	ZF7	MF7	30
2307SK	H2307X	SR80×10	1					26			
1308SK	H308X	SR90×10	2	21308CK	H308X	SR90×10	2	23	ZF8	MF8	35
2308SK	H2308X	SR90×10	1	22308EAKD1	H2308X	SR90×10	1	28			
1309SK	H309X	SR100×10.5	2	21309CK	H309X	SR100×10.5	2	25	ZF9	MF9	40
2309SK	H2309X	SR100×10	1	22309EAKD1	H2309X	SR100×10	1	31			
1310SK	H310X	SR110×11.5	2	21310CK	H310X	SR110×11.5	2	27	ZF10	MF10	45
2310SK	H2310X	SR110×10	1	22310EAKD1	H2310X	SR110×10	1	34			
1311SK	H311X	SR120×12	2	21311K	H311X	SR120×12	2	29	ZF11	MF11	50
2311SK	H2311X	SR120×10	1	22311EAKD1	H2311X	SR120×10	1	36			
1312SK	H312X	SR130×12.5	2	21312K	H312X	SR130×12.5	2	31	ZF12	MF12	55
2312SK	H2312X	SR130×10	1	22312EAKD1	H2312X	SR130×10	1	39			
1313SK	H313X	SR140×12.5	2	21313K	H313X	SR140×12.5	2	33	ZF13	MF13	60
2313SK	H2313X	SR140×10	1	22313EAKD1	H2313X	SR140×10	1	40			
1315SK	H315X	SR160×14	2	21315K	H315X	SR160×14	2	36	ZF15	MF15	65
2315SK	H2315X	SR160×10	1	22315EAKD1	H2315X	SR160×10	1	45			
1316SK	H316X	SR170×14.5	2	21316K	H316X	SR170×14.5	2	39	ZF16	MF16	70
2316SK	H2316X	SR170×10	1	22316EAKD1	H2316X	SR170×10	1	48			
1317SK	H317X	SR180×14.5	2	21317K	H317X	SR180×14.5	2	41	ZF17	MF17	75
2317SK	H2317X	SR180×10	1	22317EAKD1	H2317X	SR180×10	1	50			
1318SK	H318X	SR190×15.3	2	21318K	H318X	SR190×15.3	2	42	ZF18	MF18	80
2318SK	H2318X	SR190×9.5	1	22318EAKD1	H2318X	SR190×9.5	1	52			
1319SK	H319X	SR200×15.8	2	21319K	H319X	SR200×15.8	2	44	ZF19	MF19	85
2319SK	H2319X	SR200×9.5	1	22319EAKD1	H2319X	SR200×9.5	1	55			
1320SK	H320X	SR215×17.8	2	21320K	H320X	SR215×17.8	2	46	ZF20	MF20	90
2320SK	H2320X	SR215×9.5	1	22320EAKD1	H2320X	SR215×9.5	1	59			
1322SK	H322X	SR240×19.8	2	21322K	H322X	SR240×19.8	2	48	ZF22	MF22	100
2322SK	H2322X	SR240×9.5	1	22322EAKD1	H2322X	SR240×9.5	1	63			
-	-	-	-	22324EAKD1	H2324X	SR260×9.5	1	67	ZF24	MF24	110
-	-	-	-	22326EAKD1	H2326	SR280×9.5	1	72	ZF26	MF26	115
-	-	-	-	22328EAKD1	H2328	SR300×9.5	1	77	ZF28	MF28	125
-	-	-	-	22330EMKD1	H2330	SR320×9.5	1	82	ZF30	MF30	135
-	-	-	-	22332EMKD1	H2332	SR340×9.5	1	88	ZF32	MF32	140

Note: 2. Dimension x applies to plummer block numbers using one stabilizing ring and indicates the value of deviation from the bearing center to the plummer block center. The value is 1/2 of the width dimension of the stabilizing ring.

Plummer Blocks



Plummer block series SN3 / S3
(large bore type / for cylindrical bore bearings)

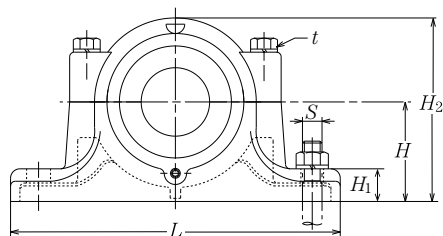
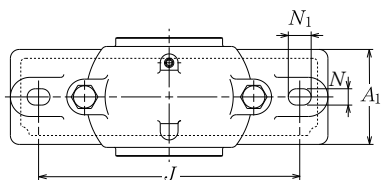

d 30 ~ 160mm

Shaft diameter		Plummer block number	Dimensions											Oil filler / drain plug size	Reference dimension S	Mass	
mm			mm														kg
d	d ₂		D	H	J	N	N ₁	A	L	A ₁	H ₁	H ₂	g	t	Nominal no.	Nominal dimension (approx.)	
30	35	SN306	72	50	150	15	20	82	185	52	22	95	37	M10	R1/8	M12	1.8
30	40	SN306X	72	50	150	15	20	82	185	52	22	95	37	M10	R1/8	M12	1.8
35	45	SN307	80	60	170	15	20	90	205	60	25	110	41	M10	R1/8	M12	2.6
40	50	SN308	90	60	170	15	20	95	205	60	25	115	43	M10	R1/8	M12	2.9
45	55	SN309	100	70	210	18	23	105	255	70	28	130	46	M12	R1/8	M16	4.1
50	60	SN310	110	70	210	18	23	115	255	70	30	135	50	M12	R1/8	M16	4.7
55	65	SN311	120	80	230	18	23	120	275	80	30	150	53	M12	R1/8	M16	5.8
60	70	SN312	130	80	230	18	23	125	280	80	30	155	56	M12	R1/8	M16	6.5
65	75	SN313	140	95	260	22	27	130	315	90	32	175	58	M16	R1/8	M20	8.7
70	80	SN314	150	95	260	22	27	130	320	90	32	185	61	M16	R1/8	M20	10
75	85	SN315	160	100	290	22	27	140	345	100	35	195	65	M16	R1/8	M20	11
80	90	SN316	170	112	290	22	27	145	345	100	35	212	68	M16	R1/8	M20	13
85	95	SN317	180	112	320	26	32	155	380	110	40	218	70	M20	R1/8	M24	15
85	100	SN317X	180	112	320	26	32	155	380	110	40	218	70	M20	R1/8	M24	15
90	100	S318	190	112	320	26	35	160	400	110	33	230	74	M20	R1/4	M24	22
90	105	S318X	190	112	320	26	35	160	400	110	33	230	74	M20	R1/4	M24	22
95	110	S319	200	125	350	26	35	170	420	120	36	245	77	M20	R1/4	M24	26
100	115	S320	215	140	350	26	35	175	420	120	38	280	83	M20	R1/4	M24	32
110	125	S322	240	150	390	28	38	190	460	130	40	300	90	M24	R1/4	M24	42
120	135	S324	260	160	450	33	42	205	540	160	50	325	96	M24	R1/4	M30	61
130	150	S326	280	170	470	33	42	215	560	160	50	350	103	M24	R1/4	M30	68
140	160	S328	300	180	520	35	45	235	630	170	55	375	112	M30	R1/4	M30	95
150	170	S330	320	190	560	35	45	245	680	180	55	395	118	M30	R1/4	M30	110
160	180	S332	340	200	580	42	52	255	710	190	60	415	124	M30	R1/4	M36	130

1) The stabilizing ring indicates the outer diameter and width dimension. 2) Dimension Y indicates the reference dimension from the shaft center to the end in the case of the shaft end shape. Note: 1. S318 or larger plummer blocks are provided with a lifting eye bolt.

Plummer Blocks

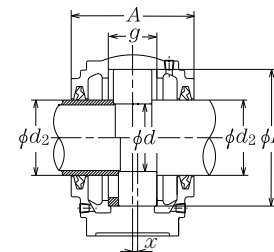

Shaft penetration type

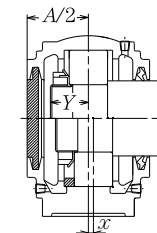

Shaft end type

Combination of self-aligning ball bearings	Applied part		Reference dimension	Rubber seal number	End cover number	Shaft dia.				
	Bearing number	Stabilizing ring Number 1)					Quantity	Combination of spherical roller bearings	Bearing number	Stabilizing ring Number 1)
1306S	SR72×9	2	19	ZF8	MF8	30				
2306S	SR72×10	1	23	ZF8	MF8	30				
1306S	SR72×9	2	19	ZF9	MF9	30				
2306S	SR72×10	1	23	ZF9	MF9	30				
1307S	SR80×10	2	21	ZF10	MF10	35				
2307S	SR80×10	1	26	ZF10	MF10	35				
1308S	SR90×10	2	23	ZF11	MF11	40				
2308S	SR90×10	1	28	ZF11	MF11	40				
1309S	SR100×10.5	2	25	ZF12	MF12	45				
2309S	SR100×10	1	31	ZF12	MF12	45				
1310S	SR110×11.5	2	27	ZF13	MF13	50				
2310S	SR110×10	1	34	ZF13	MF13	50				
1311S	SR120×12	2	29	ZF15	MF15	55				
2311S	SR120×10	1	36	ZF15	MF15	55				
1312S	SR130×12.5	2	31	ZF16	MF16	60				
2312S	SR130×10	1	39	ZF16	MF16	60				
1313S	SR140×12.5	2	33	ZF17	MF17	65				
2313S	SR140×10	1	40	ZF17	MF17	65				
1314S	SR150×13	2	34	ZF18	MF18	70				
2314S	SR150×10	1	42	ZF18	MF18	70				
1315S	SR160×14	2	36	ZF19	MF19	75				
2315S	SR160×10	1	45	ZF19	MF19	75				
1316S	SR170×14.5	2	39	ZF20	MF20	80				
2316S	SR170×10	1	48	ZF20	MF20	80				
1317S	SR180×14.5	2	41	ZF21	MF21	85				
2317S	SR180×10	1	50	ZF21	MF21	85				
1317S	SR180×14.5	2	41	ZF22	MF22	85				
2317S	SR180×10	1	50	ZF22	MF22	85				
1318S	SR190×15.3	2	42	ZF22	MF22	90				
2318S	SR190×9.5	1	52	ZF22	MF22	90				
1318S	SR190×15.3	2	42	ZF23	MF23	90				
2318S	SR190×9.5	1	52	ZF23	MF23	90				
1319S	SR200×15.8	2	44	ZF24	MF24	95				
2319S	SR200×9.5	1	55	ZF24	MF24	95				
1320S	SR215×17.8	2	46	ZF26	MF26	100				
2320S	SR215×9.5	1	59	ZF26	MF26	100				
1322S	SR240×19.8	2	48	ZF28	MF28	110				
2322S	SR240×9.5	1	63	ZF28	MF28	110				
-	-	-	67	ZF30	MF30	120				
-	-	-	72	ZF34	MF34	130				
-	-	-	77	ZF36	MF36	140				
-	-	-	82	ZF38	MF38	150				
-	-	-	88	ZF40	MF40	160				

Note: 2. Dimension x applies to plummer block numbers using one stabilizing ring and indicates the value of deviation from the bearing center to the plummer block center. The value is 1/2 of the width dimension of the stabilizing ring.

Plummer Blocks



Plummer block series SNZ3 / SZ3
(stepped bore type / for cylindrical bore bearings)

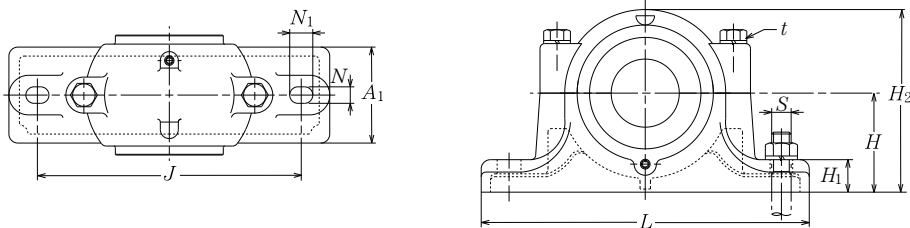

d 30 ~ 160mm

Shaft diameter mm	Plummer block number		Dimensions											Oil filler / drain plug size	Reference dimension S	Mass kg		
			mm															
d	d ₁	d ₂	D	H	J	N	N ₁	A	L	A ₁	H ₁	H ₂	g	t	Nominal dimension	(approx.)		
30	25	35	SNZ306	72	50	150	15	20	82	185	52	22	95	37	M10	R1/8	M12	2.1
30	25	40	SNZ306X	72	50	150	15	20	82	185	52	22	95	37	M10	R1/8	M12	2.1
35	30	45	SNZ307	80	60	170	15	20	90	205	60	25	110	41	M10	R1/8	M12	3.1
40	35	50	SNZ308	90	60	170	15	20	95	205	60	25	115	43	M10	R1/8	M12	3.5
45	40	55	SNZ309	100	70	210	18	23	105	255	70	28	130	46	M12	R1/8	M16	4.8
50	45	60	SNZ310	110	70	210	18	23	115	255	70	30	135	50	M12	R1/8	M16	5.6
55	50	65	SNZ311	120	80	230	18	23	120	275	80	30	150	53	M12	R1/8	M16	6.6
60	55	70	SNZ312	130	80	230	18	23	125	280	80	30	155	56	M12	R1/8	M16	7.9
65	60	75	SNZ313	140	95	260	22	27	130	315	90	32	175	58	M16	R1/8	M20	11
70	60	80	SNZ314	150	95	260	22	27	130	320	90	32	185	61	M16	R1/8	M20	12
75	65	85	SNZ315	160	100	290	22	27	140	345	100	35	195	65	M16	R1/8	M20	13
80	70	90	SNZ316	170	112	290	22	27	145	345	100	35	212	68	M16	R1/8	M20	16
85	75	95	SNZ317	180	112	320	26	32	155	380	110	40	218	70	M20	R1/8	M24	18
85	75	100	SNZ317X	180	112	320	26	32	155	380	110	40	218	70	M20	R1/8	M24	18
90	80	100	SZ318	190	112	320	26	35	160	400	110	33	230	74	M20	R1/4	M24	21
90	80	105	SZ318X	190	112	320	26	35	160	400	110	33	230	74	M20	R1/4	M24	21
95	85	110	SZ319	200	125	350	26	35	170	420	120	36	245	77	M20	R1/4	M24	23
100	90	115	SZ320	215	140	350	26	35	175	420	120	38	280	83	M20	R1/4	M24	32
110	100	125	SZ322	240	150	390	28	38	190	460	130	40	300	90	M24	R1/4	M24	42
120	110	135	SZ324	260	160	450	33	42	205	540	160	50	325	96	M24	R1/4	M30	61
130	115	150	SZ326	280	170	470	33	42	215	560	160	50	350	103	M24	R1/4	M30	68
140	125	160	SZ328	300	180	520	35	45	235	630	170	55	375	112	M30	R1/4	M30	95
150	135	170	SZ330	320	190	560	35	45	245	680	180	55	395	118	M30	R1/4	M30	110
160	140	180	SZ332	340	200	580	42	52	255	710	190	60	415	124	M30	R1/4	M36	130

1) The stabilizing ring indicates the outer diameter and width dimension. 2) Dimension Y indicates the reference dimension from the shaft center to the end in the case of the shaft end shape. Note: 1. SZ318 or larger plummer blocks are provided with a lifting eye bolt.

Plummer Blocks

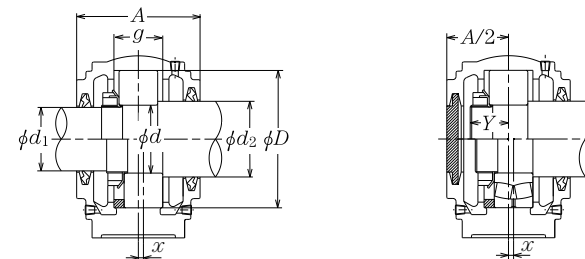

Shaft penetration type

Shaft end type

Combination of self-aligning ball bearings Bearing number	Applied part		Nut number	Washer number	Reference dimension Y ²⁾	Rubber seal number		End cover number	Shaft dia. mm			
	Stabilizing ring Number ¹⁾	Quantity				Combination of spherical roller bearings Bearing number	Stabilizing ring Number ¹⁾			Quantity	d ₁ side	d ₂ side
1306S	SR72×9	2	-	-	-	AN06	AW06X	19	ZF6	ZF8	MF6	30
2306S	SR72×10	1	-	-	-	AN06	AW06X	23	ZF6	ZF9	MF6	30
1306S	SR72×9	2	-	-	-	AN06	AW06X	19	ZF6	ZF9	MF6	30
2306S	SR72×10	1	-	-	-	AN06	AW06X	23	ZF6	ZF9	MF6	30
1307S	SR80×10	2	-	-	-	AN07	AW07X	21	ZF7	ZF10	MF7	35
2307S	SR80×10	1	-	-	-	AN07	AW07X	26	ZF7	ZF10	MF7	35
1308S	SR90×10	2	21308C	SR90×10	2	AN08	AW08X	23	ZF8	ZF11	MF8	40
2308S	SR90×10	1	22308EAD1	SR90×10	1	AN08	AW08X	28	ZF8	ZF11	MF8	40
1309S	SR100×10.5	2	21309C	SR100×10.5	2	AN09	AW09X	25	ZF9	ZF12	MF9	45
2309S	SR100×10	1	22309EAD1	SR100×10	1	AN09	AW09X	31	ZF9	ZF12	MF9	45
1310S	SR110×11.5	2	21310C	SR110×11.5	2	AN10	AW10X	27	ZF10	ZF13	MF10	50
2310S	SR110×10	1	22310EAD1	SR110×10	1	AN10	AW10X	34	ZF10	ZF13	MF10	50
1311S	SR120×12	2	21311	SR120×12	2	AN11	AW11X	29	ZF11	ZF15	MF11	55
2311S	SR120×10	1	22311EAD1	SR120×10	1	AN11	AW11X	36	ZF11	ZF15	MF11	55
1312S	SR130×12.5	2	21312	SR130×12.5	2	AN12	AW12X	31	ZF12	ZF16	MF12	60
2312S	SR130×10	1	22312EAD1	SR130×10	1	AN12	AW12X	39	ZF12	ZF16	MF12	60
1313S	SR140×12.5	2	21313	SR140×12.5	2	AN13	AW13X	33	ZF13	ZF17	MF13	65
2313S	SR140×10	1	22313EAD1	SR140×10	1	AN13	AW13X	40	ZF13	ZF17	MF13	65
1314S	SR150×13	2	21314	SR150×13	2	AN14	AW14X	34	ZF13	ZF18	MF13	70
2314S	SR150×10	1	22314EAD1	SR150×10	1	AN14	AW14X	42	ZF13	ZF18	MF13	70
1315S	SR160×14	2	21315	SR160×14	2	AN15	AW15X	36	ZF15	ZF19	MF15	75
2315S	SR160×10	1	22315EAD1	SR160×10	1	AN15	AW15X	45	ZF15	ZF19	MF15	75
1316S	SR170×14.5	2	21316	SR170×14.5	2	AN16	AW16X	39	ZF16	ZF20	MF16	80
2316S	SR170×10	1	22316EAD1	SR170×10	1	AN16	AW16X	48	ZF16	ZF20	MF16	80
1317S	SR180×14.5	2	21317	SR180×14.5	2	AN17	AW17X	41	ZF17	ZF21	MF17	85
2317S	SR180×10	1	22317EAD1	SR180×10	1	AN17	AW17X	50	ZF17	ZF21	MF17	85
1317S	SR180×14.5	2	21317	SR180×14.5	2	AN17	AW17X	41	ZF17	ZF22	MF17	85
2317S	SR180×10	1	22317EAD1	SR180×10	1	AN17	AW17X	50	ZF17	ZF22	MF17	85
1318S	SR190×15.3	2	21318	SR190×15.3	2	AN18	AW18X	42	ZF18	ZF22	MF18	90
2318S	SR190×9.5	1	22318EAD1	SR190×9.5	1	AN18	AW18X	52	ZF18	ZF22	MF18	90
1318S	SR190×15.3	2	21318	SR190×15.3	2	AN18	AW18X	42	ZF18	ZF23	MF18	90
2318S	SR190×9.5	1	22318EAD1	SR190×9.5	1	AN18	AW18X	52	ZF18	ZF23	MF18	90
1319S	SR200×15.8	2	21319	SR200×15.8	2	AN19	AW19X	44	ZF19	ZF24	MF19	95
2319S	SR200×9.5	1	22319EAD1	SR200×9.5	1	AN19	AW19X	55	ZF19	ZF24	MF19	95
1320S	SR215×17.8	2	21320	SR215×17.8	2	AN20	AW20X	46	ZF20	ZF26	MF20	100
2320S	SR215×9.5	1	22320EAD1	SR215×9.5	1	AN20	AW20X	59	ZF20	ZF26	MF20	100
1322S	SR240×19.8	2	21322	SR240×19.8	2	AN22	AW22X	48	ZF22	ZF28	MF22	110
2322S	SR240×9.5	1	22322EAD1	SR240×9.5	1	AN22	AW22X	63	ZF22	ZF28	MF22	110
-	-	-	22324EAD1	SR260×9.5	1	AN24	AW24X	67	ZF24	ZF30	MF24	120
-	-	-	22326EAD1	SR280×9.5	1	AN26	AW26	72	ZF26	ZF34	MF26	130
-	-	-	22328EAD1	SR300×9.5	1	AN28	AW28	77	ZF28	ZF36	MF28	140
-	-	-	22330EMD1	SR320×9.5	1	AN30	AW30	82	ZF30	ZF38	MF30	150
-	-	-	22332EMD1	SR340×9.5	1	AN32	AW32	88	ZF32	ZF40	MF32	160

Note: 2. Dimension x applies to plummer block numbers using one stabilizing ring and indicates the value of deviation from the bearing center to the plummer block center. The value is 1/2 of the width dimension of the stabilizing ring.

Plummer Blocks

NTN

Plummer block series SD5 / SD5G / SD6 / SD6G
(for heavy loads, double seal type / for bearings with adapters)

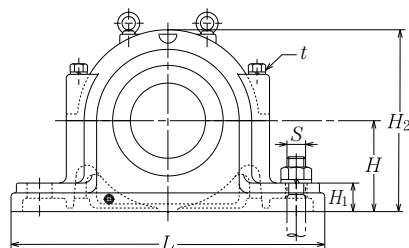
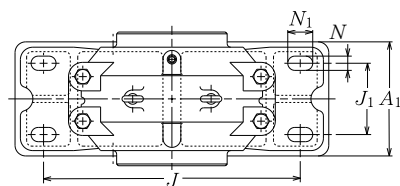

d_1 150 ~ 300mm

Shaft dia. mm	Plummer block number		Dimensions													t Nominal no.
	Floating side	Fixed side	D	H	J	J_1	N	N_1	A	L	A_1	H_1	H_2	$g^{1)}$		
150	SD534	SD534G	310	180	510	140	32	52	270	620	230	60	360	96	M24	
160	SD536	SD536G	320	190	540	150	32	52	280	650	240	60	380	96	M24	
170	SD538	SD538G	340	200	570	160	35	55	290	700	260	65	400	102	M30	
180	SD540	SD540G	360	210	610	170	35	55	300	740	270	65	420	108	M30	
200	SD544	SD544G	400	240	680	190	40	60	330	820	300	70	475	118	M30	
220	SD548	SD548G	440	260	740	200	42	62	340	880	310	85	515	130	M36	
240	SD552	SD552G	480	280	790	210	42	62	370	940	340	85	560	140	M36	
260	SD556	SD556G	500	300	830	230	50	70	390	990	370	100	590	140	M36	
280	SD560	SD560G	540	325	890	250	50	70	410	1 060	390	100	640	150	M36	
300	SD564	SD564G	580	355	930	270	57	77	440	1 110	420	110	690	160	M42	
150	SD634	SD634G	360	210	610	170	35	55	300	740	270	65	420	130	M30	
160	SD636	SD636G	380	225	640	180	40	60	320	780	290	70	450	136	M30	
170	SD638	SD638G	400	240	680	190	40	60	330	820	300	70	475	142	M30	
180	SD640	SD640G	420	250	710	200	42	62	350	860	320	85	500	148	M36	
200	SD644	SD644G	460	280	770	210	42	62	360	920	330	85	550	155	M36	
220	SD648	SD648G	500	300	830	230	50	70	390	990	370	100	590	165	M36	
240	SD652	SD652G	540	325	890	250	50	70	410	1 060	390	100	640	175	M36	
260	SD656	SD656G	580	355	930	270	57	77	440	1 110	420	110	690	185	M42	

Plummer Blocks

NTN

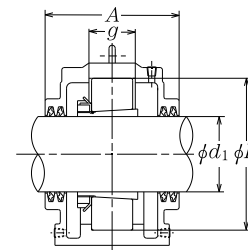

Shaft penetration type

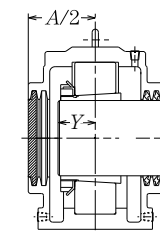

Shaft end type

Oil filler / drain plug size	Reference dimension S Nominal dimension	Mass kg (approx.)	Applied part Combination of spherical roller bearings Bearing number	Adapter number	Reference dimension mm $Y^{2)}$	Rubber seal number	End cover number	Shaft dia. mm d_1
R3/8	M30	95	22234EMKD1	H3134	75	ZF34	MF34	150
R3/8	M30	110	22236EMKD1	H3136	76	ZF36	MF36	160
R3/8	M30	130	22238EMKD1	H3138	80	ZF38	MF38	170
R3/8	M30	150	22240EMKD1	H3140	84	ZF40	MF40	180
R3/8	M36	210	22244EMKD1	H3144	90	ZF44	MF44	200
R3/8	M36	240	22248EMKD1	H3148	98	ZF48	MF48	220
R3/8	M36	320	22252EMKD1	H3152	105	ZF52	MF52	240
R3/8	M42	370	22256EMKD1	H3156	107	ZF56	MF56	260
R3/8	M42	460	22260EMKD1	H3160	114	ZF60	MF60	280
R3/8	M48	560	22264EMKD1	H3164	122	ZF64	MF64	300
R3/8	M30	150	22334EMKD1	H2334	92	ZF34	MF34	150
R3/8	M36	180	22336EMKD1	H2336	96	ZF36	MF36	160
R3/8	M36	210	22338EMKD1	H2338	100	ZF38	MF38	170
R3/8	M36	240	22340EMKD1	H2340	104	ZF40	MF40	180
R3/8	M36	300	22344EMKD1	H2344	109	ZF44	MF44	200
R3/8	M42	370	22348EMKD1	H2348	116	ZF48	MF48	220
R3/8	M42	460	22352EMKD1	H2352	123	ZF52	MF52	240
R3/8	M48	560	22356EMKD1	H2356	130	ZF56	MF56	260

1) Dimension g indicates the bearing width dimension of the floating side. The fixed side (code G) is larger than the bearing width dimension by 0.5 mm.

2) Dimension Y indicates the reference dimension from the shaft center to the end in the case of the shaft end shape.

Plummer Blocks

NTN

Plummer block series SD2 / SD2G / SD3 / SD3G
(for heavy loads, stepped bore type / for cylindrical bore bearings)

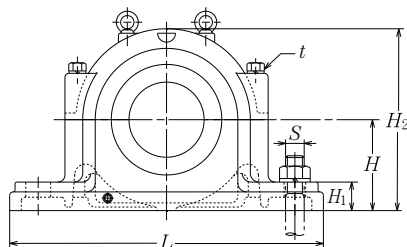
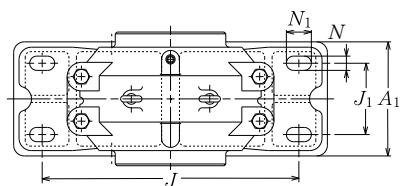

d 170 ~ 320mm

d	Shaft diameter mm		Plummer block number		Dimensions mm													t Nominal no.
	d ₁	d ₂	Floating side	Fixed side	D	H	J	J ₁	N	N ₁	A	L	A ₁	H ₁	H ₂	g ¹⁾		
170	160	190	SD234	SD234G	310	180	510	140	32	52	270	620	230	60	360	96	M24	
180	170	200	SD236	SD236G	320	190	540	150	32	52	280	650	240	60	380	96	M24	
190	180	210	SD238	SD238G	340	200	570	160	35	55	290	700	260	65	400	102	M30	
200	190	220	SD240	SD240G	360	210	610	170	35	55	300	740	270	65	420	108	M30	
220	210	240	SD244	SD244G	400	240	680	190	40	60	330	820	300	70	475	118	M30	
240	230	260	SD248	SD248G	440	260	740	200	42	62	340	880	310	85	515	130	M36	
260	250	280	SD252	SD252G	480	280	790	210	42	62	370	940	340	85	560	140	M36	
280	260	300	SD256	SD256G	500	300	830	230	50	70	390	990	370	100	590	140	M36	
300	280	320	SD260	SD260G	540	325	890	250	50	70	410	1 060	390	100	640	150	M36	
320	300	340	SD264	SD264G	580	355	930	270	57	77	440	1 110	420	110	690	160	M42	
170	160	190	SD334	SD334G	360	210	610	170	35	55	300	740	270	65	420	130	M30	
180	170	200	SD336	SD336G	380	225	640	180	40	60	320	780	290	70	450	136	M30	
190	180	210	SD338	SD338G	400	240	680	190	40	60	330	820	300	70	475	142	M30	
200	190	220	SD340	SD340G	420	250	710	200	42	62	350	860	320	85	500	148	M36	
220	210	240	SD344	SD344G	460	280	770	210	42	62	360	920	330	85	550	155	M36	
240	230	260	SD348	SD348G	500	300	830	230	50	70	390	990	370	100	590	165	M36	
260	250	280	SD352	SD352G	540	325	890	250	50	70	410	1 060	390	100	640	175	M36	
280	260	300	SD356	SD356G	580	355	930	270	57	77	440	1 110	420	110	690	185	M42	

Plummer Blocks

NTN

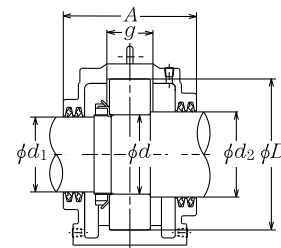

Shaft penetration type

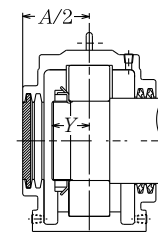

Shaft end type

Oil filler / drain plug size	Reference dimension S Nominal dimension	Mass (approx.) kg	Applied part			Reference dimension Y ²⁾ mm	Rubber seal number		End cover number	Shaft dia. mm d
			Bearing number	Adapter number	Washer / lock plate number		(d ₁ side)	(d ₂ side)		
R3/8	M30	95	22234EMD1	AN34	AW34	75	ZF36	ZF42	MF36	170
R3/8	M30	110	22236EMD1	AN36	AW36	76	ZF38	ZF44	MF38	180
R3/8	M30	130	22238EMD1	AN38	AW38	80	ZF40	ZF46	MF40	190
R3/8	M30	150	22240EMD1	AN40	AW40	84	ZF42	ZF48	MF42	200
R3/8	M36	210	22244EMD1	AN44	AL44	90	ZF46	ZF52	MF46	220
R3/8	M36	240	22248EMD1	AN48	AL44	98	GS50S	ZF56	MF50	240
R3/8	M36	320	22252EMD1	AN52	AL52	105	ZF54	ZF60	MF54	260
R3/8	M42	370	22256EMD1	AN56	AL52	107	ZF56	ZF64	MF56	280
R3/8	M42	460	22260EMD1	AN60	AL60	114	ZF60	ZF68	MF60	300
R3/8	M48	560	22264EMD1	AN64	AL64	122	ZF64	GS72	MF64	320
R3/8	M30	150	22334EMD1	AN34	AW34	92	ZF36	ZF42	MF36	170
R3/8	M36	180	22336EMD1	AN36	AW36	96	ZF38	ZF44	MF38	180
R3/8	M36	210	22338EMD1	AN38	AW38	100	ZF40	ZF46	MF40	190
R3/8	M36	240	22340EMD1	AN40	AW40	104	ZF42	ZF48	MF42	200
R3/8	M36	300	22344EMD1	AN44	AL44	109	ZF46	ZF52	MF46	220
R3/8	M42	370	22348EMD1	AN48	AL44	116	GS50S	ZF56	MF50	240
R3/8	M42	460	22352EMD1	AN52	AL52	123	ZF54	ZF60	MF54	260
R3/8	M48	560	22356EMD1	AN56	AL52	130	ZF56	ZF64	MF56	280

1) Dimension g indicates the bearing width dimension of the floating side. The fixed side (code G) is larger than the bearing width dimension by 0.5 mm.

2) Dimension Y indicates the reference dimension from the shaft center to the end in the case of the shaft end shape.

Plummer Blocks



Plummer block series SN30 / SN31
(standard type / for bearings with adapter)

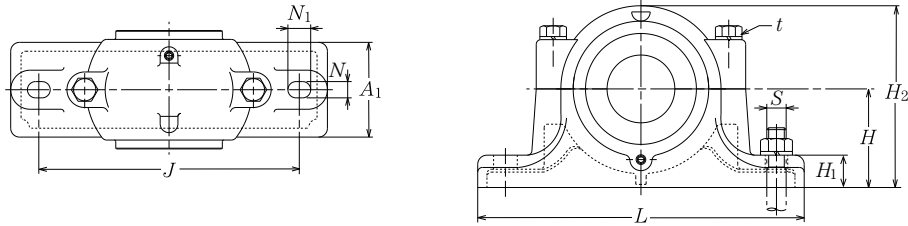

d_1 100 ~ 170mm

Shaft dia. mm	Plummer block number	Dimensions										Oil filler / drain plug size	Reference dimension S	Mass kg		
		D	H	J	N	N ₁	A	L	A ₁	H ₁	H ₂				g	t Nominal no.
110	SN3024	180	112	320	26	32	150	380	110	40	217	56	M20	R1/4	M24	17
115	SN3026	200	125	350	26	32	160	410	120	45	240	62	M20	R1/4	M24	20
125	SN3028	210	140	350	26	32	170	410	120	45	260	63	M20	R1/4	M24	25
135	SN3030	225	150	380	28	36	175	445	130	50	283	66	M24	R1/4	M24	30
140	SN3032	240	150	390	28	36	190	460	130	50	290	70	M24	R1/4	M24	33
150	SN3034	260	160	450	33	42	200	530	160	60	310	77	M24	R1/4	M30	46
160	SN3036	280	170	470	33	42	210	550	160	60	330	84	M24	R1/4	M30	52
170	SN3038	290	170	470	33	42	210	550	160	60	335	85	M24	R1/4	M30	52
100	SN3122	180	112	320	26	32	155	380	110	40	217	66	M20	R1/4	M24	18
110	SN3124	200	125	350	26	32	165	410	120	45	240	72	M20	R1/4	M24	21
115	SN3126	210	140	350	26	32	170	410	120	45	260	74	M20	R1/4	M24	26
125	SN3128	225	150	380	28	36	180	445	130	50	283	78	M24	R1/4	M24	32
135	SN3130	250	150	420	33	42	200	500	150	50	295	90	M24	R1/4	M30	40
140	SN3132	270	160	450	33	42	215	530	160	60	315	96	M24	R1/4	M30	45
150	SN3134	280	170	470	33	42	220	550	160	60	330	98	M24	R1/4	M30	51
160	SN3136	300	180	520	33	42	230	610	170	70	355	106	M30	R1/4	M30	63
170	SN3138	320	190	560	33	42	240	650	180	70	375	114	M30	R1/4	M30	76

1) The stabilizing ring indicates the outer diameter and width dimension. 2) Dimension Y indicates the reference dimension from the shaft center to the end in the case of the shaft end shape.
Note: 1. SN3028 or larger and SN3126 or larger plummer blocks are provided with a lifting eye bolt.

Plummer Blocks

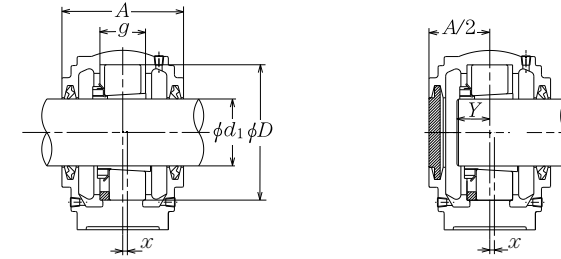

Shaft penetration type

Shaft end type

Bearing number	Applied part Combination of spherical roller bearings Adapter Plummer block number	Stabilizing ring Plummer block number 1)	Stabilizing ring Quantity	Reference dimension mm Y ²⁾	Rubber seal number	End cover number	Shaft dia.
							mm d ₁
23024EAKD1	H3024X	SR180×10	1	47	ZF24	MF24	110
23026EAKD1	H3026	SR200×10	1	51	ZF26	MF26	115
23028EAKD1	H3028	SR210×10	1	53	ZF28	MF28	125
23030EAKD1	H3030	SR225×10	1	56	ZF30	MF30	135
23032EAKD1	H3032	SR240×10	1	61	ZF32	MF32	140
23034EAKD1	H3034	SR260×10	1	66	ZF34	MF34	150
23036EAKD1	H3036	SR280×10	1	70	ZF36	MF36	160
23038EAKD1	H3038	SR290×10	1	72	ZF38	MF38	170
23122EAKD1	H3122X	SR180×10	1	51	ZF22	MF22	100
23124EAKD1	H3124X	SR200×10	1	55	ZF24	MF24	110
23126EAKD1	H3126	SR210×10	1	57	ZF26	MF26	115
23128EAKD1	H3128	SR225×10	1	60	ZF28	MF28	125
23130EAKD1	H3130	SR250×10	1	68	ZF30	MF30	135
23132EAKD1	H3132	SR270×10	1	74	ZF32	MF32	140
23134EAKD1	H3134	SR280×10	1	76	ZF34	MF34	150
23136EAKD1	H3136	SR300×10	1	81	ZF36	MF36	160
23138EMKD1	H3138	SR320×10	1	86	ZF38	MF38	170

Note: 2. Dimension x applies to plummer block numbers using one stabilizing ring and indicates the value of deviation from the bearing center to the plummer block center. The value is 1/2 of the width dimension of the stabilizing ring.

Plummer Blocks

NTN

Plummer block series SD30/SD30G
(for heavy loads, double seal type / for bearings with adapters)

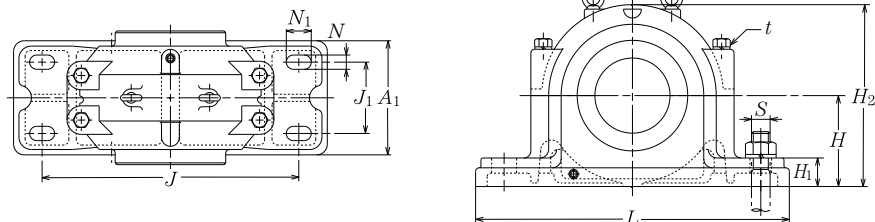

d_1 150 ~ 400mm

Shaft dia. mm	Plummer block number ¹⁾		Dimensions													t Nominal no.
	Floating side	Fixed side	D	H	J	J_1	N	N_1	A	L	A_1	H_1	H_2	$g^2)$		
150	SD3034	SD3034G	260	160	450	110	32	42	230	540	200	50	320	77	M24	
160	SD3036	SD3036G	280	170	470	120	32	42	250	560	220	50	340	84	M24	
170	SD3038	SD3038G	290	170	470	120	32	42	250	560	220	50	345	85	M24	
180	SD3040	SD3040G	310	180	510	140	32	52	270	620	250	60	360	92	M24	
200	SD3044	SD3044G	340	200	570	160	35	55	290	700	280	65	400	100	M30	
220	SD3048	SD3048G	360	210	610	170	35	55	300	740	290	65	420	102	M30	
240	SD3052	SD3052G	400	240	680	190	40	60	340	820	320	70	475	114	M30	
260	SD3056	SD3056G	420	250	710	200	42	62	350	860	340	85	500	116	M36	
280	SD3060	SD3060G	460	280	770	210	42	62	360	920	350	85	550	128	M36	
300	SD3064	SD3064G	480	280	790	210	42	62	380	940	360	85	560	131	M36	
380	SD3080	SD3080G	600	365	960	270	57	77	430	1140	420	120	710	158	M42	
400	SD3084	SD3084G	620	375	980	270	57	77	430	1160	420	120	735	160	M42	

Plummer Blocks

NTN

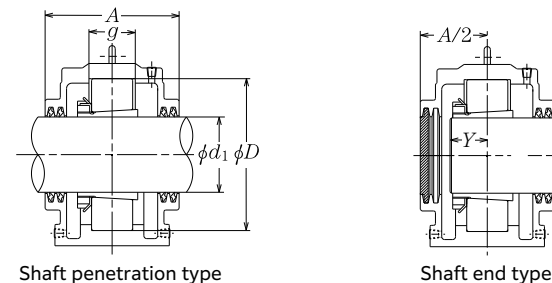

Oil filler / drain plug size	Reference dimension S Nominal dimension	Mass kg (approx.)	Applied part Combination of spherical roller bearings Bearing number Adapter number		Reference dimension mm Y ³⁾	Rubber seal number	End cover number	Shaft dia. mm d_1
R3/8	M30	70	23034EAKD1	H3034	66	ZF34	MF34	150
R3/8	M30	80	23036EAKD1	H3036	70	ZF36	MF36	160
R3/8	M30	85	23038EAKD1	H3038	72	ZF38	MF38	170
R3/8	M30	100	23040EMKD1	H3040	76	ZF40	MF40	180
R3/8	M30	130	23044EMKD1	H3044	79	ZF44	MF44	200
R3/8	M30	150	23048EMKD1	H3048	84	ZF48	MF48	220
R3/8	M36	210	23052EMKD1	H3052	90	ZF52	MF52	240
R3/8	M36	240	23056EMKD1	H3056	95	ZF56	MF56	260
R3/8	M36	300	23060EMKD1	H3060	105	ZF60	MF60	280
R3/8	M36	320	23064EMKD1	H3064	108	ZF64	MF64	300
R3/8	M48	620	23080BK	H3080	131	GS80	MF80	380
R3/8	M48	690	23084BK	H3084	132	GS84	MF84	400

1) SD3068, SD3072, and SD3076 have the same dimensions as SD3368, SD3372, and SD3376. Therefore, when these models are necessary, select "SD3368, SD3372, and SD3376."

2) Dimension g indicates the bearing width dimension of the floating side. The fixed side (code G) is larger than the bearing width dimension by 0.5 mm.

3) Dimension Y indicates the reference dimension from the shaft center to the end in the case of the shaft end shape.

Plummer Blocks

NTN

Plummer block series SD31/SD31G
(for heavy loads, double seal type / for bearings with adapters)

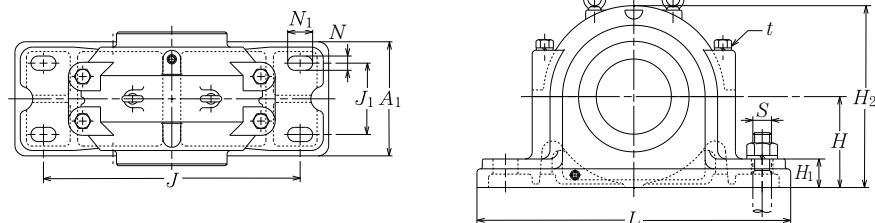

d_1 150 ~ 400mm

Shaft dia. mm	Plummer block number ¹⁾		Dimensions													t Nominal no.
	Floating side	Fixed side	D	H	J	J_1	N	N_1	A	L	A_1	H_1	H_2	$g^2)$		
150	SD3134	SD3134G	280	170	470	120	35	42	250	560	220	50	340	98	M24	
160	SD3136	SD3136G	300	180	520	140	35	52	270	630	250	55	365	106	M30	
170	SD3138	SD3138G	320	190	560	140	35	55	310	680	270	55	385	114	M30	
180	SD3140	SD3140G	340	200	570	160	35	55	310	700	280	65	400	122	M30	
200	SD3144	SD3144G	370	225	640	180	40	60	320	780	310	70	450	130	M30	
220	SD3148	SD3148G	400	240	680	190	40	60	330	820	320	70	475	138	M30	
240	SD3152	SD3152G	440	260	740	200	42	62	360	880	350	85	515	154	M36	
260	SD3156	SD3156G	460	280	770	210	42	62	360	920	350	85	550	156	M36	
280	SD3160	SD3160G	500	300	830	230	50	70	390	990	380	100	590	170	M36	
300	SD3164	SD3164G	540	325	890	250	50	70	430	1 060	400	100	640	186	M36	
340	SD3172	SD3172G	600	365	960	310	57	77	470	1 140	460	120	710	202	M42	
360	SD3176	SD3176G	620	375	980	320	57	77	500	1 160	490	120	735	204	M42	
380	SD3180	SD3180G	650	390	1 040	340	57	77	520	1 220	510	125	770	210	M42	
400	SD3184	SD3184G	700	420	1 070	380	57	77	560	1 250	550	135	820	234	M42	

Plummer Blocks

NTN

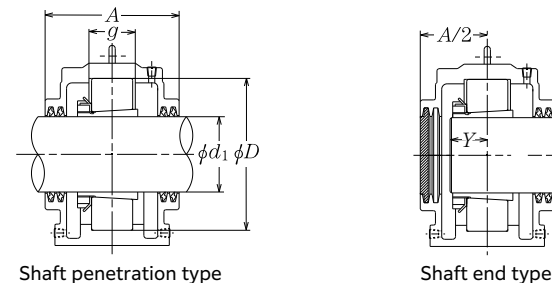

Oil filler / drain plug size	Reference dimension S Nominal dimension	Mass kg (approx.)	Applied part Combination of spherical roller bearings Bearing number	Adapter number	Reference dimension mm Y ³⁾	Rubber seal number	End cover number	Shaft dia. mm d_1
R3/8	M30	75	23134EAD1	H3134	76	ZF34	MF34	150
R3/8	M30	94	23136EAKD1	H3136	81	ZF36	MF36	160
R3/8	M30	110	23138EMKD1	H3138	86	ZF38	MF38	170
R3/8	M30	130	23140EMKD1	H3140	91	ZF40	MF40	180
R3/8	M36	180	23144EMKD1	H3144	96	ZF44	MF44	200
R3/8	M36	210	23148EMKD1	H3148	102	ZF48	MF48	220
R3/8	M36	240	23152EMKD1	H3152	112	ZF52	MF52	240
R3/8	M36	310	23156EMKD1	H3156	115	ZF56	MF56	260
R3/8	M42	400	23160EMKD1	H3160	124	ZF60	MF60	280
R3/8	M42	480	23164EMKD1	H3164	135	ZF64	MF64	300
R3/8	M48	630	23172BK	H3172	159	GS72	MF72	340
R3/8	M48	850	23176BK	H3176	162	GS76	MF76	360
R3/8	M48	960	23180BK	H3180	167	GS80	MF80	380
R3/8	M48	1 080	23184BK	H3184	187	GS84	MF84	400

1) SD3168 has the same dimensions as SD3468. Therefore, when this model is necessary, select "SD3468."
2) Dimension g indicates the bearing width dimension of the floating side. The fixed side (code G) is larger than the bearing width dimension by 0.5 mm.
3) Dimension Y indicates the reference dimension from the shaft center to the end in the case of the shaft end shape.

Plummer Blocks



Plummer block series SV5
(unit standard type / for bearings with adapter assembly)

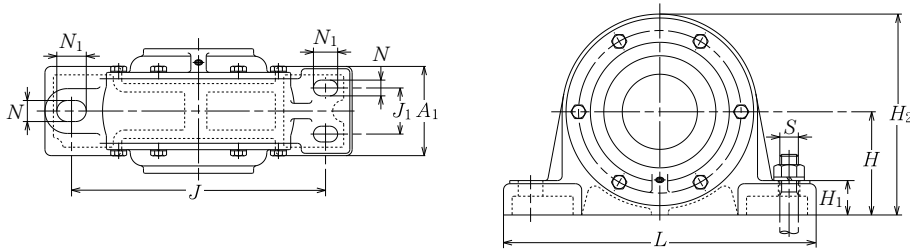

d_1 20 ~ 135mm

Shaft dia. mm	Plummer block number	Dimensions											Oil filler / drain plug size	Reference dimension S	Mass kg			
		mm																
d_1		D	H	J	J ₁	N	N ₁	L	A	A ₁	g	A ₃	H ₁	H ₂	Nominal dimension	Quantity	(approx.)	
20	SV505	52	45	130	-	16	20	165	73	46	27	31	22	85	R1/8	M14	2	2.1
25	SV506	62	50	150	-	16	20	185	80	52	30	34	22	95	R1/8	M14	2	2.7
30	SV507	72	56	150	-	16	20	185	85	52	33	37.5	22	106	R1/8	M14	2	3.3
35	SV508	80	60	170	-	16	20	205	95	60	37	40.5	25	118	R1/8	M14	2	4.5
40	SV509	85	63	170	-	16	23	205	98	60	39	42.5	25	125	R1/8	M14	2	4.5
45	SV510	90	67	170	-	16	23	205	100	60	39	42.5	25	128	R1/8	M14	2	4.8
50	SV511	100	71	210	-	16	23	255	106	70	42	47	28	140	R1/8	M14	2	5.8
55	SV512	110	80	210	-	21	25	255	112	70	46	47	30	155	R1/8	M18	2	6.8
60	SV513	120	85	230	-	21	25	275	118	80	49	50	30	165	R1/8	M18	2	9.5
65	SV515	130	90	230	-	21	25	280	118	80	50	50	30	175	R1/8	M18	2	10
70	SV516	140	100	260	-	25	30	315	136	90	56	58	32	195	R1/8	M22	2	14
75	SV517	150	100	260	-	25	30	315	140	90	56	60	32	195	R1/8	M22	2	15
80	SV518	160	112	290	-	25	30	345	150	100	62	65	35	224	R1/8	M22	2	20
85	SV519	170	112	290	-	25	30	345	165	100	62	72.5	35	224	R1/8	M22	2	20
90	SV520	180	125	320	56	23	32	380	170	110	70	75	40	243	R1/8	M20	4	26
100	SV522	200	132	350	60	23	32	410	190	120	82	82	45	265	R1/4	M20	4	30
110	SV524	215	140	350	60	23	32	410	190	120	82	82	45	280	R1/4	M20	4	36
115	SV526	230	150	380	65	23	32	450	200	130	86	87	50	300	R1/4	M20	4	45
125	SV528	250	160	420	80	23	32	500	218	150	94	96	50	315	R1/4	M20	4	53
135	SV530	270	170	450	92	29	42	540	236	160	103	105	60	335	R1/4	M24	4	63

1) The stabilizing ring indicates the outer diameter and width dimension.
2) Dimension Y indicates the reference dimension from the shaft center to the end in the case of the shaft end shape.
Note: 1. SV520 or larger plummer blocks are provided with a lifting eye bolt.
G-36

Plummer Blocks

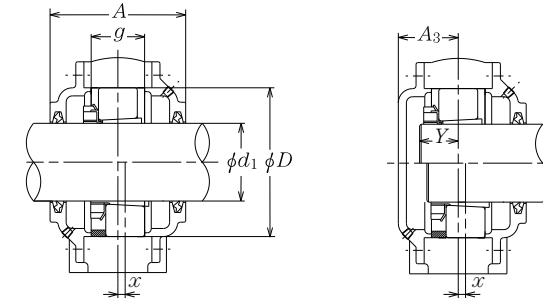

Shaft penetration type

Shaft end type

Combination of self-aligning ball bearings	Applied part		Reference dimension mm	Rubber seal number	Shaft dia. mm					
	Bearing number	Adapter number				Combination of spherical roller bearings	Adapter number	Stabilizing ring		
Bearing number	Adapter number	Stabilizing ring Number ¹⁾	Quantity	Bearing number	Adapter number	Stabilizing ring Number ¹⁾	Quantity	Y ²⁾		
1205SK	H205X	SR52×6	2	-	-	-	-	17		
2205SK	H305X	SR52×9	1	22205EAKD1	H305X	SR52×9	1	19	ZF5	20
1206SK	H206X	SR62×7	2	-	-	-	-	18		
2206SK	H306X	SR62×10	1	22206EAKD1	H306X	SR62×10	1	20	ZF6	25
1207SK	H207X	SR72×8	2	-	-	-	-	19		
2207SK	H307X	SR72×10	1	22207EAKD1	H307X	SR72×10	1	22	ZF7	30
1208SK	H208X	SR80×9.5	2	-	-	-	-	21		
2208SK	H308X	SR80×7	2	22208EAKD1	H308X	SR80×7	2	23	ZF8	35
1209SK	H209X	SR85×10	2	-	-	-	-	22		
2209SK	H309X	SR85×8	2	22209EAKD1	H309X	SR85×8	2	24	ZF9	40
1210SK	H210X	SR90×9.5	2	-	-	-	-	24		
2210SK	H310X	SR90×8	2	22210EAKD1	H310X	SR90×8	2	25	ZF10	45
1211SK	H211X	SR100×10.5	2	-	-	-	-	25		
2211SK	H311X	SR100×8.5	2	22211EAKD1	H311X	SR100×8.5	2	27	ZF11	50
1212SK	H212X	SR110×12	2	-	-	-	-	26		
2212SK	H312X	SR110×9	2	22212EAKD1	H312X	SR110×9	2	29	ZF12	55
1213SK	H213X	SR120×13	2	-	-	-	-	28		
2213SK	H313X	SR120×9	2	22213EAKD1	H313X	SR120×9	2	32	ZF13	60
1215SK	H215X	SR130×12.5	2	-	-	-	-	30		
2215SK	H315X	SR130×9.5	2	22215EAKD1	H315X	SR130×9.5	2	33	ZF15	65
1216SK	H216X	SR140×15	2	-	-	-	-	32		
2216SK	H316X	SR140×11.5	2	22216EAKD1	H316X	SR140×11.5	2	36	ZF16	70
1217SK	H217X	SR150×14	2	-	-	-	-	34		
2217SK	H317X	SR150×10	2	22217EAKD1	H317X	SR150×10	2	38	ZF17	75
1218SK	H218X	SR160×16	2	-	-	-	-	35		
2218SK	H318X	SR160×11	2	22218EAKD1	H318X	SR160×11	2	40	ZF18	80
-	-	-	-	23218EMKD1	H2318X	SR160×9.6	1	46		
1219SK	H219X	SR170×15	2	-	-	-	-	37		
2219SK	H319X	SR170×9.5	2	22219EAKD1	H319X	SR170×9.5	2	43	ZF19	85
1220SK	H220X	SR180×18	2	-	-	-	-	39		
2220SK	H320X	SR180×12	2	22220EAKD1	H320X	SR180×12	2	45	ZF20	90
-	-	-	-	23220EMKD1	H2320X	SR180×9.7	1	52		
1222SK	H222X	SR200×22	2	-	-	-	-	42		
2222SK	H322X	SR200×14.5	2	22222EAKD1	H322X	SR200×14.5	2	50	ZF22	100
-	-	-	-	23222EMKD1	H2322X	SR200×12.2	1	58		
-	-	-	-	22224EAKD1	H3124X	SR215×12	2	53		
-	-	-	-	23224EMKD1	H2324X	SR215×6	1	62	ZF24	110
-	-	-	-	22226EAKD1	H3126	SR230×11	2	57		
-	-	-	-	23226EMKD1	H2326	SR230×6	1	65	ZF26	115
-	-	-	-	22228EAKD1	H3128	SR250×13	2	60		
-	-	-	-	23228EMKD1	H2328	SR250×6	1	70	ZF28	125
-	-	-	-	22230EAKD1	H3130	SR270×15	2	65		
-	-	-	-	23230EMKD1	H2330	SR270×7	1	76	ZF30	135

Note: 2. Dimension x applies to plummer block numbers using one stabilizing ring and indicates the value of deviation from the bearing center to the plummer block center. The value is 1/2 of the width dimension of the stabilizing ring.
3. Adapters for series 12 bearings can also be used with H2 and H3 series bearings.

Plummer Blocks



Plummer block series SV5
(unit single standard type / for bearings with adapter assembly)

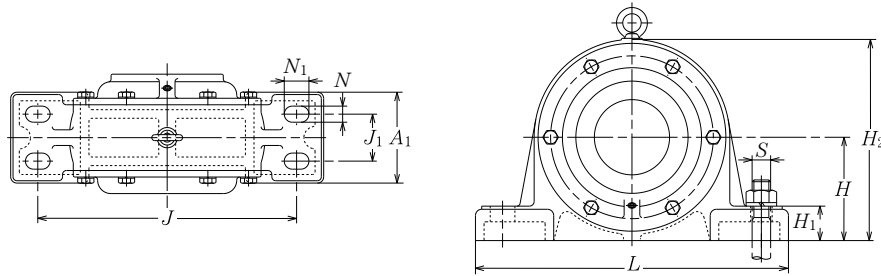

d_1 140 ~ 300mm

Shaft dia. mm	Plummer block number	Dimensions												Oil filler / drain plug size	Reference dimension S	Mass kg		
		mm																
d_1		D	H	J	J_1	N	N_1	L	A	A_1	g	A_3	H_1	H_2	Nominal dimension	Quantity (approx.)		
140	SV532	290	190	470	92	29	50	560	250	170	113	112	60	375	R1/4	M24	4	76
150	SV534	310	200	560	92	29	50	660	258	180	122	116	65	405	R1/4	M24	4	89
160	SV536	320	200	560	92	29	50	660	258	180	122	116	65	405	R1/4	M24	4	100
170	SV538	340	212	580	104	33	54	680	300	190	130	137	65	425	R1/4	M27	4	110
180	SV540	360	224	610	130	33	54	740	300	224	138	136	85	450	R1/4	M27	4	130
200	SV544	400	250	680	148	36	60	820	330	250	154	151	95	500	R1/4	M30	4	196
220	SV548	440	280	740	166	40	66	880	340	280	170	156	100	560	R1/4	M33	4	260
240	SV552	480	300	790	180	43	72	940	370	300	184	173	105	600	R1/4	M36	4	318
260	SV556	500	315	830	190	43	72	990	390	315	186	185	110	630	R1/4	M36	4	336
280	SV560	540	335	890	200	46	78	1060	410	335	202	196	115	670	R1/4	M39	4	433
300	SV564	580	355	930	215	49	84	1110	440	355	218	211	120	710	R1/4	M42	4	507

Plummer Blocks

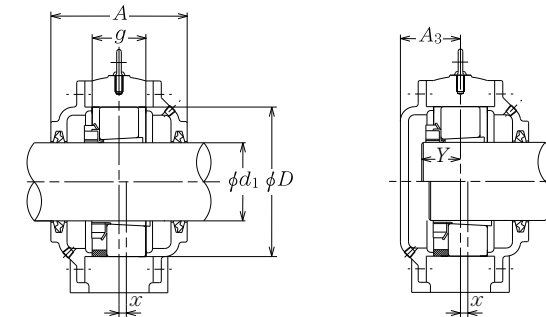

Shaft penetration type

Shaft end type

Applied part				Reference dimension mm	Rubber seal number	Shaft dia. mm					
Combination of self-aligning ball bearings	Combination of spherical roller bearings	Reference dimension Y ²⁾	Shaft dia. d_1								
Bearing number	Adapter number	Stabilizing ring Number ¹⁾	Quantity	Bearing number	Adapter number	Stabilizing ring Number ¹⁾	Quantity				
-	-	-	-	22232EAKD1	H3132	SR290 × 16.5	2	71			
-	-	-	-	23232EMKD1	H2332	SR290 × 9	1	83	ZF32	140	
-	-	-	-	22234EMKD1	H3134	SR310 × 18	2	75			
-	-	-	-	23234EMKD1	H2334	SR310 × 12	1	87	ZF34	150	
-	-	-	-	22236EMKD1	H3136	SR320 × 18	2	76			
-	-	-	-	23236EMKD1	H2336	SR320 × 10	1	89	ZF36	160	
-	-	-	-	22238EMKD1	H3138	SR340 × 19	2	80			
-	-	-	-	23238EMKD1	H2338	SR340 × 10	1	94	ZF38	170	
-	-	-	-	22240EMKD1	H3140	SR360 × 20	2	84			
-	-	-	-	23240EMKD1	H2340	SR360 × 10	1	99	ZF40	180	
-	-	-	-	22244EMKD1	H3144	SR400 × 23	2	90			
-	-	-	-	23244EMKD1	H2344	SR400 × 10	1	108	ZF44	200	
-	-	-	-	22248EMKD1	H3148	SR440 × 25	2	98			
-	-	-	-	23248EMKD1	H2348	SR440 × 10	1	118	ZF48	220	
-	-	-	-	22252EMKD1	H3152	SR480 × 27	2	105			
-	-	-	-	23252EMKD1	H2352	SR480 × 10	1	127	ZF52	240	
-	-	-	-	22256EMKD1	H3156	SR500 × 28	2	107			
-	-	-	-	23256EMKD1	H2356	SR500 × 10	1	130	ZF56	260	
-	-	-	-	22260EMKD1	H3160	SR540 × 31	2	114			
-	-	-	-	23260EMKD1	H2360	SR540 × 10	1	160	ZF60	280	
-	-	-	-	22264EMKD1	H3164	SR580 × 34	2	122			
-	-	-	-	23264EMKD1	H2364	SR580 × 10	1	151	ZF64	300	

1) The stabilizing ring indicates the outer diameter and width dimension.
2) Dimension Y indicates the reference dimension from the shaft center to the end in the case of the shaft end shape.
Note: 1. SV520 or larger plummer blocks are provided with a lifting eye bolt.

Note: 2. Dimension x applies to plummer block numbers using one stabilizing ring and indicates the value of deviation from the bearing center to the plummer block center. The value is 1/2 of the width dimension of the stabilizing ring.
3. Adapters for series 12 bearings can also be used with H2 and H3 series bearings.

Plummer Blocks



Plummer block series SV2
(unit and stepped bore type / for cylindrical bore bearings)

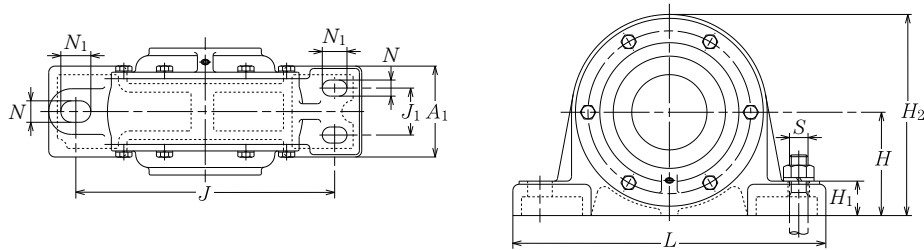

d 25 ~ 140mm

Shaft diameter mm	Plummer block number	Dimensions mm														Oil filler / drain plug size	Reference dimension S	Mass kg	
		d	d ₁	d ₂	D	H	J	J ₁	N	N ₁	L	A	A ₁	g	A ₃				H ₁
25	20 30	SV205	52	45	130	-	16	20	165	73	46	27	31	22	85	R1/8	M14	2	2.0
30	25 35	SV206	62	50	150	-	16	20	185	80	52	30	34	22	95	R1/8	M14	2	2.6
35	30 45	SV207	72	56	150	-	16	20	185	85	52	33	37.5	22	106	R1/8	M14	2	3.1
40	35 50	SV208	80	60	170	-	16	20	205	95	60	37	40.5	25	118	R1/8	M14	2	4.3
45	40 55	SV209	85	63	170	-	16	23	205	98	60	39	42.5	25	125	R1/8	M14	2	4.3
50	45 60	SV210	90	67	170	-	16	23	205	100	60	39	42.5	25	128	R1/8	M14	2	4.6
55	50 65	SV211	100	71	210	-	16	23	255	106	70	42	47	28	140	R1/8	M14	2	5.5
60	55 70	SV212	110	80	210	-	21	25	255	112	70	46	47	30	155	R1/8	M18	2	6.5
65	60 75	SV213	120	85	230	-	21	25	275	118	80	49	50	30	165	R1/8	M18	2	9.5
70	60 80	SV214	125	90	230	-	21	25	280	118	80	50	50	30	175	R1/8	M18	2	10
75	65 85	SV215	130	90	230	-	21	25	280	118	80	50	50	30	175	R1/8	M18	2	10
80	70 90	SV216	140	100	260	-	25	30	315	136	90	56	58	32	195	R1/8	M22	2	14
85	75 95	SV217	150	100	260	-	25	30	315	140	90	56	60	32	195	R1/8	M22	2	15
90	80 100	SV218	160	112	290	-	25	30	345	150	100	62	65	35	224	R1/8	M22	2	20
95	85 110	SV219	170	112	290	-	25	30	345	165	100	62	72.5	35	224	R1/8	M22	2	20
100	90 115	SV220	180	125	320	56	23	32	380	170	110	70	75	40	243	R1/8	M20	4	26
110	100 125	SV222	200	132	350	60	23	32	410	190	120	82	82	45	265	R1/4	M20	4	30
120	110 135	SV224	215	140	350	60	23	32	410	190	120	82	82	45	280	R1/4	M20	4	36
130	115 145	SV226	230	150	380	65	23	32	450	200	130	86	87	50	300	R1/4	M20	4	44
140	125 155	SV228	250	160	420	80	23	32	500	218	150	94	96	50	315	R1/4	M20	4	52

1) The stabilizing ring indicates the outer diameter and width dimension.
2) Dimension Y indicates the reference dimension from the shaft center to the end in the case of the shaft end shape.
Note: 1. SV220 or larger plummer blocks are provided with a lifting eye bolt.

Plummer Blocks

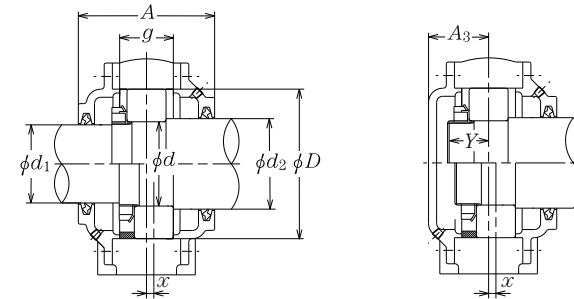

Shaft penetration type

Shaft end type

Applied part						Nut number	Washer number	Reference dimension mm	Rubber seal number	Shaft dia. mm	
Combination of self-aligning ball bearings Bearing number	Stabilizing ring Number 1)	Quantity	Combination of spherical roller bearings Bearing number	Stabilizing ring Number 1)	Quantity						Y 2)
1205S	SR52×6	2	-	-	-	AN05	AW05X	17	ZF5	ZF7	25
2205S	SR52×9	1	22205EAD1	SR52×9	1	AN05	AW05X	19	ZF5	ZF7	25
1206S	SR62×7	2	-	-	-	AN06	AW06X	18	ZF6	ZF8	30
2206S	SR62×10	1	22206EAD1	SR62×10	1	AN06	AW06X	20	ZF6	ZF8	30
1207S	SR72×8	2	-	-	-	AN07	AW07X	19	ZF7	ZF10	35
2207S	SR72×10	1	22207EAD1	SR72×10	1	AN07	AW07X	22	ZF7	ZF10	35
1208S	SR80×9.5	2	-	-	-	AN08	AW08X	21	ZF8	ZF11	40
2208S	SR80×7	2	22208EAD1	SR80×7	2	AN08	AW08X	23	ZF8	ZF11	40
1209S	SR85×10	2	-	-	-	AN09	AW09X	22	ZF9	ZF12	45
2209S	SR85×8	2	22209EAD1	SR85×8	2	AN09	AW09X	24	ZF9	ZF12	45
1210S	SR90×9.5	2	-	-	-	AN10	AW10X	24	ZF10	ZF13	50
2210S	SR90×8	2	22210EAD1	SR90×8	2	AN10	AW10X	25	ZF10	ZF13	50
1211S	SR100×10.5	2	-	-	-	AN11	AW11X	25	ZF11	ZF15	55
2211S	SR100×8.5	2	22211EAD1	SR100×8.5	2	AN11	AW11X	27	ZF11	ZF15	55
1212S	SR110×12	2	-	-	-	AN12	AW12X	26	ZF12	ZF16	60
2212S	SR110×9	2	22212EAD1	SR110×9	2	AN12	AW12X	29	ZF12	ZF16	60
1213S	SR120×13	2	-	-	-	AN13	AW13X	28	ZF13	ZF17	65
2213S	SR120×9	2	22213EAD1	SR120×9	2	AN13	AW13X	32	ZF13	ZF17	65
1214S	SR125×13	2	-	-	-	AN14	AW14X	28	ZF13	ZF18	70
2214S	SR125×9.5	2	22214EAD1	SR125×9.5	2	AN14	AW14X	32	ZF13	ZF18	70
1215S	SR130×12.5	2	-	-	-	AN15	AW15X	30	ZF15	ZF19	75
2215S	SR130×9.5	2	22215EAD1	SR130×9.5	2	AN15	AW15X	33	ZF15	ZF19	75
1216S	SR140×15	2	-	-	-	AN16	AW16X	32	ZF16	ZF20	80
2216S	SR140×11.5	2	22216EAD1	SR140×11.5	2	AN16	AW16X	36	ZF16	ZF20	80
1217S	SR150×14	2	-	-	-	AN17	AW17X	34	ZF17	ZF21	85
2217S	SR150×10	2	22217EAD1	SR150×10	2	AN17	AW17X	38	ZF17	ZF21	85
1218S	SR160×15	2	-	-	-	AN18	AW18X	35	ZF18	ZF22	90
2218S	SR160×11	2	22218EAD1	SR160×11	2	AN18	AW18X	40	ZF18	ZF22	90
-	-	-	23218EMD1	SR160×9.6	1	-	-	46	-	-	-
1219S	SR170×15	2	-	-	-	AN19	AW19X	37	ZF19	ZF24	95
2219S	SR170×9.5	2	22219EAD1	SR170×9.5	2	AN19	AW19X	43	ZF19	ZF24	95
1220S	SR180×18	2	-	-	-	AN20	AW20X	39	ZF20	ZF26	100
2220S	SR180×12	2	22220EAD1	SR180×12	2	AN20	AW20X	45	ZF20	ZF26	100
-	-	-	23220EMD1	SR180×9.7	1	-	-	52	-	-	-
1222S	SR200×22	2	-	-	-	AN22	AW22X	42	ZF22	ZF28	110
2222S	SR200×14.5	2	22222EAD1	SR200×14.5	2	AN22	AW22X	50	ZF22	ZF28	110
-	-	-	23222EMD1	SR200×12.2	1	-	-	58	-	-	-
-	-	-	22224EAD1	SR215×12	2	AN24	AW24X	53	ZF24	ZF30	120
-	-	-	23224EMD1	SR215×6	1	-	-	62	-	-	-
-	-	-	22226EAD1	SR230×11	2	AN26	AW26	57	ZF26	GS33	130
-	-	-	23226EMD1	SR230×6	1	-	-	65	-	-	-
-	-	-	22228EAD1	SR250×13	2	AN28	AW28	60	ZF28	GS35	140
-	-	-	23228EMD1	SR250×6	1	-	-	70	-	-	-

Note: 2. Dimension x applies to plummer block numbers using one stabilizing ring and indicates the value of deviation from the bearing center to the plummer block center. The value is 1/2 of the width dimension of the stabilizing ring.

Plummer Blocks



Plummer block series SV2
(single and different aperture type / for cylindrical bore bearings)

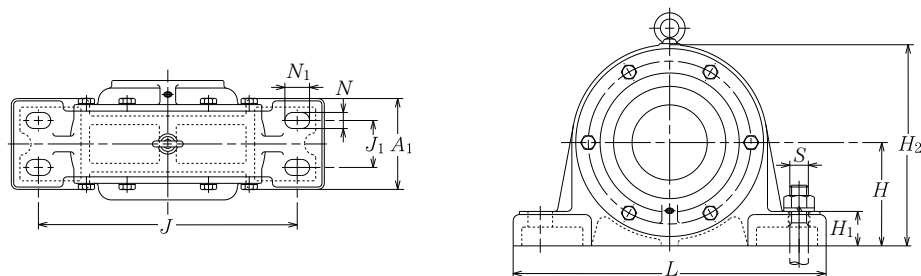

d 150 ~ 320mm

Shaft diameter mm	Plummer block number	Dimensions															Oil filler / drain plug size	Reference dimension S	Mass kg	
		mm																		
d	d ₁	d ₂	D	H	J	J ₁	N	N ₁	L	A	A ₁	g	A ₃	H ₁	H ₂		Quantity	(approx.)		
150	135	165	SV230	270	170	450	92	29	42	540	236	160	103	105	60	335	R1/4	M24	4	62
160	140	175	SV232	290	190	470	92	29	50	560	250	170	113	112	60	375	R1/4	M24	4	75
170	150	190	SV234	310	200	560	92	29	50	660	258	180	122	116	65	405	R1/4	M24	4	87
180	160	200	SV236	320	200	560	92	29	50	660	258	180	122	116	65	405	R1/4	M24	4	98
190	170	210	SV238	340	212	580	104	33	54	680	300	190	130	137	65	425	R1/4	M27	4	110
200	180	230	SV240	360	224	610	130	33	54	740	300	224	138	136	85	450	R1/4	M27	4	130
220	200	250	SV244	400	250	680	148	36	60	820	330	250	154	151	95	500	R1/4	M30	4	196
240	220	260	SV248	440	280	740	166	40	66	880	340	280	170	156	100	560	R1/4	M33	4	260
260	240	280	SV252	480	300	790	180	43	72	940	370	300	184	173	105	600	R1/4	M36	4	318
280	260	300	SV256	500	315	830	190	43	72	990	390	315	186	185	110	630	R1/4	M36	4	336
300	280	320	SV260	540	335	890	200	46	78	1060	410	335	202	196	115	670	R1/4	M39	4	433
320	300	340	SV264	580	355	930	215	49	84	1110	440	355	218	211	120	710	R1/4	M42	4	507

Plummer Blocks

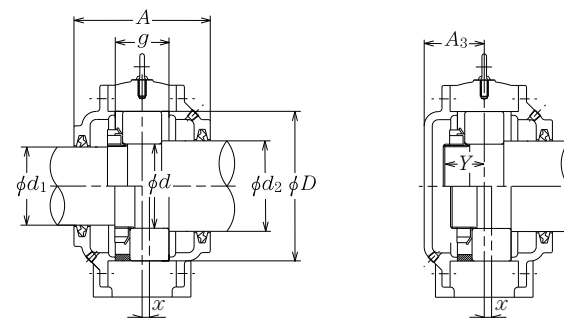

Shaft penetration type

Shaft end type

Combination of self-aligning ball bearings	Applied part		Nut number	Washer number	Reference dimension mm	Rubber seal number		Shaft dia. mm
	Bearing number	Stabilizing ring Number ¹⁾				Bearing number	Stabilizing ring Number ¹⁾	
-	-	-	AN30	AW30	65 76	ZF30	GS37	150
-	-	-	AN32	AW32	71 83	ZF32	GS39	160
-	-	-	AN34	AW34	75 87	ZF34	ZF42	170
-	-	-	AN36	AW36	76 89	ZF36	ZF44	180
-	-	-	AN38	AW38	80 94	ZF38	ZF46	190
-	-	-	AN40	AW40	84	ZF40	GS50S	200
-	-	-	AN44	AL44	90	ZF44	ZF54	220
-	-	-	AN48	AL44	98	ZF48	ZF56	240
-	-	-	AN52	AL52	105	ZF52	ZF60	260
-	-	-	AN56	AL52	107	ZF56	ZF64	280
-	-	-	AN60	AL60	114	ZF60	ZF68	300
-	-	-	AN64	AL64	122	ZF64	GS72	320

1) The stabilizing ring indicates the outer diameter and width dimension. 2) Dimension Y indicates the reference dimension from the shaft center to the end in the case of the shaft end shape. Note: 1. SV220 or larger plummer blocks are provided with a lifting eye bolt.

Note: 2. Dimension x applies to plummer block numbers using one stabilizing ring and indicates the value of deviation from the bearing center to the plummer block center. The value is 1/2 of the width dimension of the stabilizing ring.

Introduction of Catalogs and Technical Reviews

Contents of Introduction of Catalogs and Technical Review

Introduction of catalogs	H- 2
Introduction of technical reviews	H- 24



Catalogs and technical reviews issued by **NTN** are as follows.
Please refer to the **NTN** website (<https://www.ntnglobal.com>) for the latest information.

1. Introduction of catalogs

● Catalogs related to rolling bearings

LARGE BEARINGS

CAT.No.2250/E

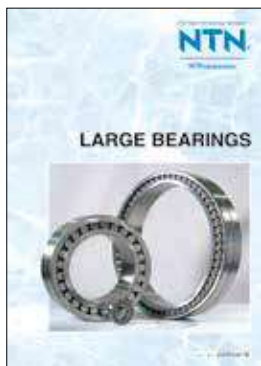

Precision Rolling Bearings

CAT.No.2260/E



● Catalogs related to rolling bearings

**ULTAGE series
Spherical Roller Bearings
with High-strength Cage [EMA Type]**

CAT.No.3036/E

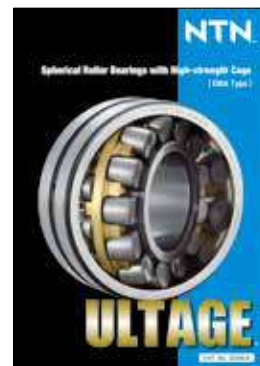

**ULTAGE series
Cylindrical Roller Bearings**

CAT.No.3037/E

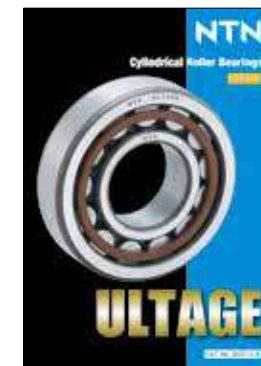

**ULTAGE series
Spherical Roller Bearings
[Type EA, Type EM]**

CAT.No.3033/E

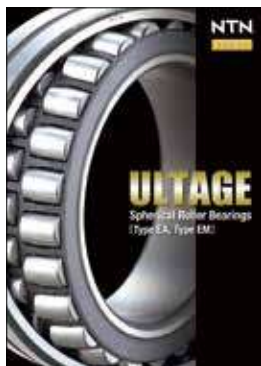

**ULTAGE series
Large Size Tapered Roller Bearings**

CAT.No.3035/E

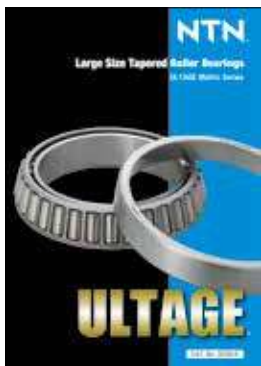

**ULTAGE series
Deep Groove Ball Bearings
for High-speed Servo Motors [Type MA]**

CAT.No.3103/E



**ULTAGE series
Sealed Spherical Roller Bearings
[WA Type]**

CAT.No.3703/E



● Catalogs related to rolling bearings

ULTAGE series
Sealed Four Row Tapered Roller Bearings
for Rolling Mill Roll-Necks [CROU...LL type]
CAT.No.3801/E

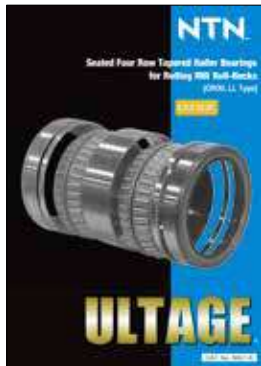

ULTAGE series
IC Tag Integrated Bearing
CAT.No.3019/E



● Catalogs related to rolling bearings

Large Size, Long Operating Life Bearing - EA type
CAT.No.3024/E



Bearings with solid grease
CAT.No.3022/E

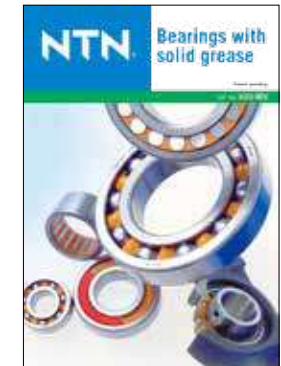

Ball Bearings Shield and Seal Types
CAT.No.3015/E



Long-Life AS Series TAB/ETA Bearings
CAT.No.3025/E



Bearings for Special Environments Ultra Final Series
CAT.No.3023/E



Ultra Final Series Bearings for Clean Environment
CAT.No.3028/E

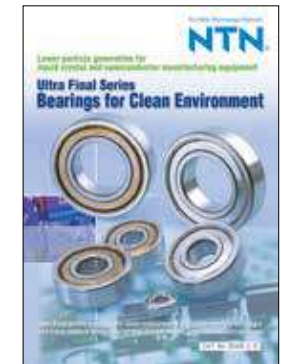

● Catalogs related to rolling bearings

**Insulated Bearings
MEGAOHM™ Series**

CAT.No.3030/E

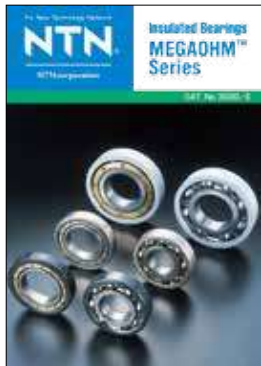

NTN Bearings for Wind Turbines

CAT.No.8405/JE

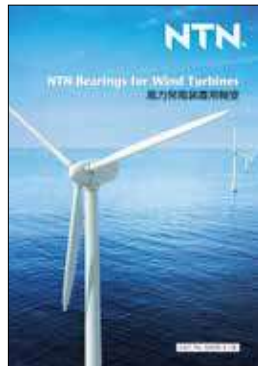

**Asymmetrical Spherical
Roller Bearings
for Wind Turbine Main Shafts**

CAT.No.3038/E



Integrated Rotation Sensor Bearings

CAT.No.3032/E

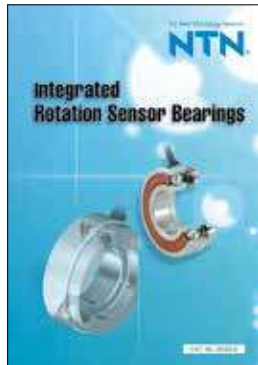

● Catalogs related to rolling bearings

**Adapters, Withdrawal Sleeves,
Locknuts, Lockwashers
& Lockplates, Hydraulic Nuts**

CAT.No.4201/E



HUB BEARINGS

CAT.No.4601/E



● Catalogs related to needle roller bearings

Needle Roller Bearings

CAT.No.2300/E

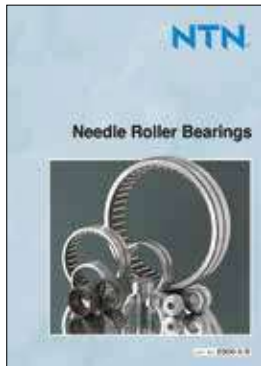

HK-F Type Drawn Cup Needle Roller Bearings

CAT.No.3029/JE



Cam Followers & Roller Followers

CAT.No.3604/JE



● Catalogs related to bearing units

Bearing Units

CAT.No.2400/E

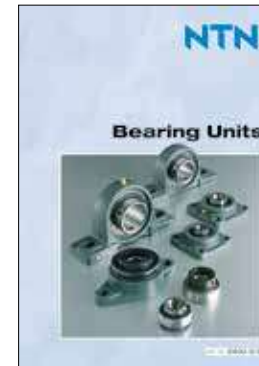

Bearing Units with Ductile Cast Iron Housing

CAT.No.3901/E



Bearing Units Steel Series

CAT.No.3902/E

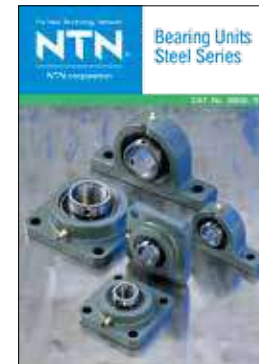

Bearing Units Stainless Series

CAT.No.3903/E

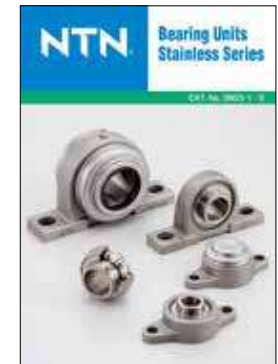

● Catalogs related to bearing units

**Bearing Units
Plastic Housing Series**

CAT.No.3904/E



**Triple-Sealed Bearings
for Bearing Units**

CAT.No.3905/E



● Catalogs related to plummer blocks

PLUMMER BLOCKS

CAT.No.2500/E

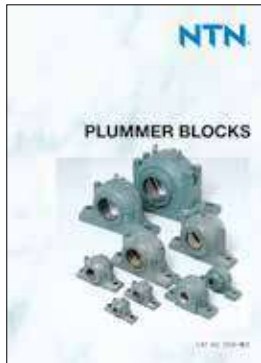

● Catalogs related to sliding bearings

BEAREE

CAT.No.5100/JE



**MLE Bearings
<BEAREE>**

CAT.No.5116/E

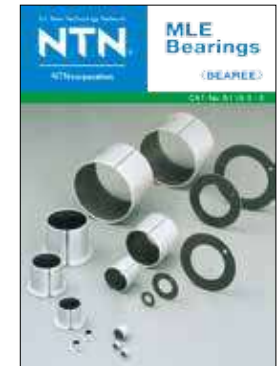

**Miniature Plastic Sliding Screws
BEAREE**

CAT.No.5112/E



Sintered Products BEARPHITE

CAT.No.5202/JE



● Catalogs related to sliding bearings

Spherical Plain Bearings

CAT.No.5301/E

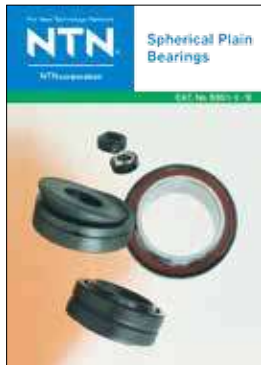

● Catalogs related to constant velocity joints

**CONSTANT VELOCITY JOINTS
for industrial machines**

CAT.No.5603/E



TRI-BALL JOINT

CAT.No.5602/E

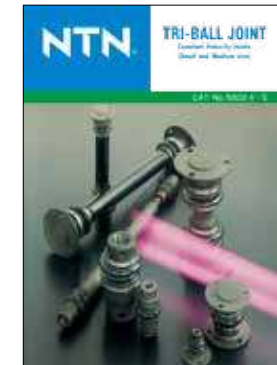

**Constant Velocity Joints
for Industrial Machines:
Application Examples**

CAT.No.5604/E



● Catalogs related to clutches

CLUTCHES

CAT.No.2900/E

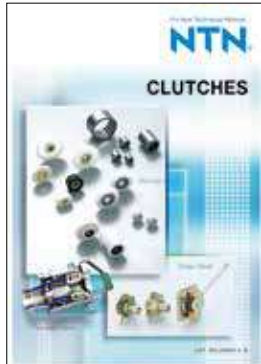

● Electric motors and actuators

Electric Motor and Actuator

CAT.No.7202/JE



● Auto tensioners

Auto Tensioner

CAT.No.7201/JE



● Catalogs related to parts feeders

PARTS FEEDER

CAT.No.7018/E





● Catalogs related to precision machinery / robots

Wrist Joint Module i-WRIST™

CAT.No.6511/E



Multi Track Magnetic Ring

CAT.No.6512/JE



● Catalogs related to maintenance

Condition Monitoring System for Wind Turbines

CAT.No.8406/E



Care and Maintenance of Bearings

CAT.No.3017/E



Bearing Handling

CAT.No.9103/E

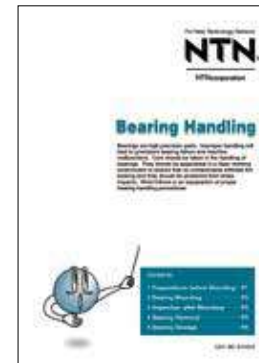



● Catalogs related to natural energy products

NTN Green Power Station

CAT.No.8407/E



NTN Micro Hydro Turbine

CAT.No.8409/E



● Handbooks

ROLLING BEARINGS HANDBOOK

CAT.No.9012/E

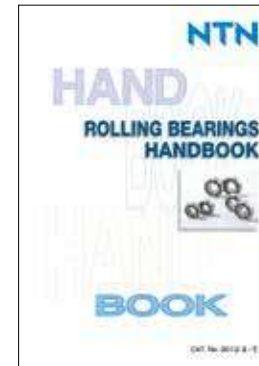

NEEDLE ROLLER BEARINGS HANDBOOK

CAT.No.9013/E

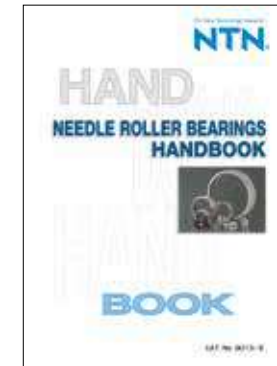

BEARING UNITS HANDBOOK

CAT.No.9011/E

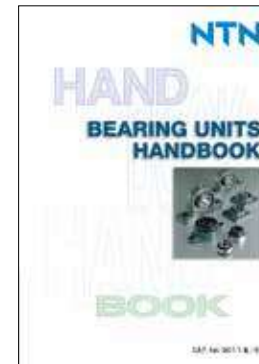

ENGINEERING PLASTICS HANDBOOK

CAT.No.9014/E

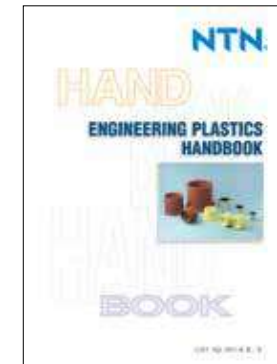

● Handbooks

OIL-IMPREGNATED SINTERED BEARINGS HANDBOOK

CAT.No.9015/E

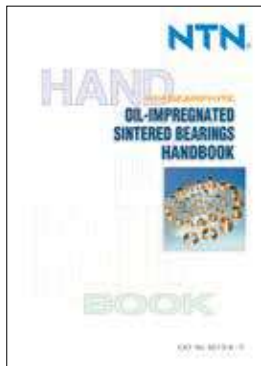

● Guide book for each industrial field

AUTOMOTIVE PRODUCTS GUIDE BOOK

CAT.No.8024/JE



AEROSPACE BEARINGS GUIDE BOOK

CAT.No.8025/JE



Products for Metals Industry

CAT.No.8301/E

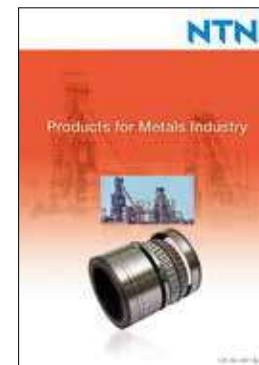

Product Catalog for Mining Equipment

CAT.No.8602/E

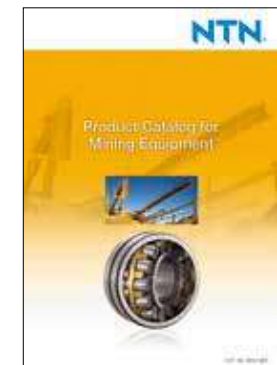

- Guide book for each industrial field

General Catalog for Office Equipment Products

CAT.No.8701/E

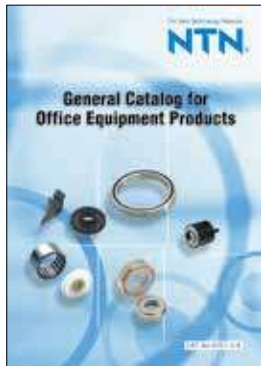

Product Catalog for Paper Manufacturing Machinery

CAT.No.8901/E

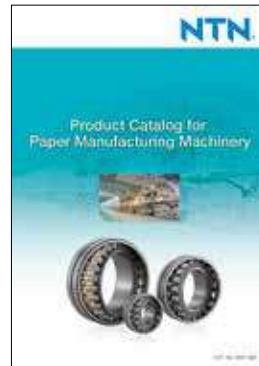

Product Catalog for Food Machinery

CAT.No.8902/E

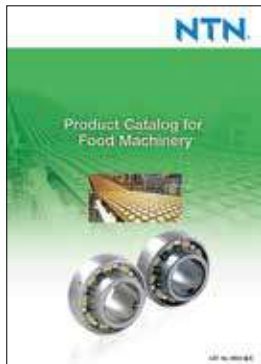

Parts Feeder Guide Book

CAT.No.7019/E

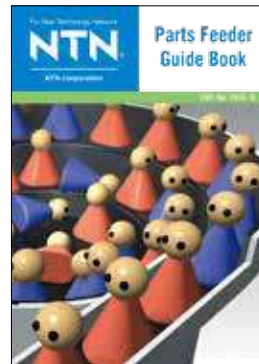

- Guide book for each industrial field

Cement Equipment Product Guidebook

CAT.No.8026/E



- Corporate Profile

Corporate Profile



2. Introduction of technical reviews

No. 87 (November 2019)
Special issue on
"Automotive Products for Electric,
Autonomous and Low Fuel Consumption"



No. 86 (October 2018)
Special issue on
"Robotics and Sensing Products
and Machine Tools"



No. 85 (October 2017)
Special issue on
"Automotive Products
and Electric Module Products"



No. 84 (November 2016)
Special issue :
Green Energy Products and Machine
Tool / Manufacturing Technology



No. 83 (October 2015)
Special issue for
Automotive Module Products



No. 82 (October 2014)
Special issue :
Composite Material, Technology
and Products for Industrial Machines

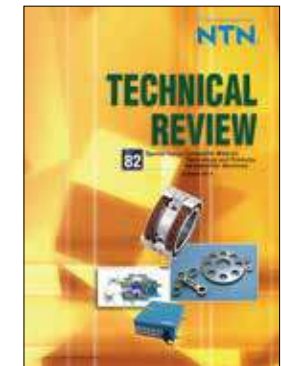

No. 81 (November 2013)
Special issue :
Automotive Products
and Technologies



No. 80 (October 2012)
Special issue :
Environment and Energy



No. 79 (November 2011)
Special issue:
Automotive Technologies



No. 78 (October 2010)
Special issue:
Products for Industrial Machinery
and Elemental Technologies



No. 75 (October 2007)
Special issue:
Automotive Environmental
Technologies



No. 74 (November 2006)
Special issue:
Products for Industrial Machinery



No. 77 (December 2009)
Special issue:
Efforts for the Environment



No. 76 (October 2008)
Special issue:
Elemental Technologies



No. 73 (October 2005)
Special issue:
Automotive Products



No. 72 (October 2004)
Special issue:
Machine Tool Bearings
and Precision Apparatus Products



Appendix Table

Appendix Table Contents

Appendix table - 1: Boundary dimensions of radial bearings (Tapered roller bearings not included)	I- 2
Appendix table - 2: Boundary dimensions of tapered roller bearings	I-10
Appendix table - 3: Boundary dimensions of single direction thrust bearings	I-14
Appendix table - 4: Comparison table of SI and CGS series gravity units	I-20
Appendix table - 5: SI-customary unit conversion table	I-20
Appendix table - 6: Tenth power multiples of SI unit	I-21
Appendix table - 7: Dimensional tolerance for shafts	I-22
Appendix table - 8: Dimensional tolerance for housing bores	I-24
Appendix table - 9: Basic tolerance	I-26
Appendix table -10: Viscosity conversion table	I-27
Appendix table -11: Kgf to N conversion table	I-28
Appendix table -12: Inch / millimeter conversion table	I-29
Appendix table -13: Hardness conversion table (reference)	I-30
Appendix table -14: Kg to lb conversion table	I-32
Appendix table -15: °C to °F conversion table	I-33
Appendix table -16: Greek alphabet list	I-34



Appendix table-1: Boundary dimensions of radial bearings (Tapered roller bearings not included)-1

Single row radial ball bearings		67												68		78			
Double row radial ball bearings																			
Cylindrical roller bearings										N28		N38		NN48					
Needle roller bearings														NA48					
Spherical roller bearings																			
Nominal bearing bore diameter <i>d</i>		Diameter series 7							Diameter series 8										
Number	Dimension	Dimension series						Nominal bearing outer diameter <i>D</i>	Dimension series										
		17	27	37	47	17~47	08		18	28	38	48	58	68	08	18~68			
		Nominal width <i>B</i>						Chamfer dimension <i>r</i> 's min	Nominal width <i>B</i>										Chamfer dimension <i>r</i> 's min
—	0.6	2	0.8	—	—	—	0.05		2.5	—	1	—	1.4	—	—	—	—	0.05	
1	1	2.5	1	—	—	—	0.05	3	—	1	—	1.5	—	—	—	—	0.05		
—	1.5	3	1	—	1.8	—	0.05	4	—	1.2	—	2	—	—	—	—	0.05		
2	2	4	1.2	—	2	—	0.05	5	—	1.5	—	2.3	—	—	—	—	0.08		
—	2.5	5	1.5	1.8	2.3	—	0.08	6	—	1.8	—	2.6	—	—	—	—	0.08		
3	3	6	2	2.5	3	—	0.08	7	—	2	—	3	—	—	—	—	0.1		
4	4	7	2	2.5	3	—	0.08	9	—	2.5	3.5	4	—	—	—	—	0.1		
5	5	8	2	2.5	3	—	0.08	11	—	3	4	5	—	—	—	—	0.15		
6	6	10	2.5	3	3.5	—	0.1	13	—	3.5	5	6	—	—	—	—	0.15		
7	7	11	2.5	3	3.5	—	0.1	14	—	3.5	5	6	—	—	—	—	0.15		
8	8	12	2.5	—	3.5	—	0.1	16	—	4	5	6	8	—	—	—	0.2		
9	9	14	3	—	4.5	—	0.1	17	—	4	5	6	8	—	—	—	0.2		
00	10	15	3	—	4.5	—	0.1	19	—	5	6	7	9	—	—	—	0.3		
01	12	18	4	—	5	—	0.2	21	—	5	6	7	9	—	—	—	0.3		
02	15	21	4	—	5	—	0.2	24	—	5	6	7	9	—	—	—	0.3		
03	17	23	4	—	5	—	0.2	26	—	5	6	7	9	—	—	—	0.3		
04	20	27	4	—	5	7	0.2	32	4	7	8	10	12	16	22	0.3	0.3		
/22	22	30	4	—	5	7	0.2	34	4	7	—	10	—	16	22	0.3	0.3		
05	25	32	4	—	5	7	0.2	37	4	7	8	10	12	16	22	0.3	0.3		
/28	28	35	4	—	5	7	0.2	40	4	7	—	10	—	16	22	0.3	0.3		
06	30	37	4	—	5	7	0.2	42	4	7	8	10	12	16	22	0.3	0.3		
/32	32	40	4	—	6	8	0.2	44	4	7	—	10	—	16	22	0.3	0.3		
07	35	44	5	—	7	9	0.3	47	4	7	8	10	12	16	22	0.3	0.3		
08	40	50	6	—	8	10	0.3	52	4	7	8	10	12	16	22	0.3	0.3		
09	45	55	6	—	8	10	0.3	58	4	7	8	10	13	18	23	0.3	0.3		
10	50	62	6	—	10	12	0.3	65	5	7	10	12	15	20	27	0.3	0.3		
11	55	68	7	—	10	13	0.3	72	7	9	11	13	17	23	30	0.3	0.3		
12	60	75	7	—	12	15	0.3	78	7	10	12	14	18	24	32	0.3	0.3		
13	65	80	7	—	12	15	0.3	85	7	10	13	15	20	27	36	0.3	0.6		
14	70	85	7	—	12	15	0.3	90	8	10	13	15	20	27	36	0.3	0.6		
15	75	90	7	—	12	15	0.3	95	8	10	13	15	20	27	36	0.3	0.6		
16	80	95	7	—	12	15	0.3	100	8	10	13	15	20	27	36	0.3	0.6		
17	85	105	10	—	15	—	0.6	110	9	13	16	19	25	34	45	0.3	1		
18	90	110	10	—	15	—	0.6	115	9	13	16	19	25	34	45	0.3	1		
19	95	115	10	—	15	—	0.6	120	9	13	16	19	25	34	45	0.3	1		
20	100	120	10	—	15	—	0.6	125	9	13	16	19	25	34	45	0.3	1		
21	105	125	10	—	15	—	0.6	130	9	13	16	19	25	34	45	0.3	1		
22	110	135	13	—	19	—	1	140	10	16	19	23	30	40	54	0.6	1		
24	120	145	13	—	19	—	1	150	10	16	19	23	30	40	54	0.6	1		
26	130	160	16	—	23	—	1	165	11	18	22	26	35	46	63	0.6	1.1		
28	140	170	16	—	23	—	1	175	11	18	22	26	35	46	63	0.6	1.1		
30	150	180	16	—	23	—	1	190	13	20	24	30	40	54	71	0.6	1.1		
32	160	190	16	—	23	—	1	200	13	20	24	30	40	54	71	0.6	1.1		
34	170	200	16	—	23	—	1	215	14	22	27	34	45	60	80	0.6	1.1		

Appendix table-1: Boundary dimensions of radial bearings (Tapered roller bearings not included)-2 Unit: mm

Single row radial ball bearings		69		79										160		60		70					
Double row radial ball bearings																							
Cylindrical roller bearings		N19		N29		NN39		NN49						N10		N20		NN30					
Needle roller bearings										NA49		NA59		NA69									
Spherical roller bearings										239		249						230					
Nominal bearing bore diameter <i>d</i>		Diameter series 9										Diameter series 0											
Number	Dimension	Dimension series										Nominal bearing outer diameter <i>D</i>	Dimension series										
		09	19	29	39	49	59	69	09	19~39	49~69		00	10	20	30	40	50	60	00	10~60		
		Nominal width <i>B</i>										Chamfer dimension <i>r</i> 's min	Nominal width <i>B</i>										Chamfer dimension <i>r</i> 's min
—	0.6	—	—	—	—	—	—	—	—	—	—		—	—	—	—	—	—	—	—	—		
1	1	4	—	1.6	—	2.3	—	—	—	—	—	—	—	—	—	—	—	—	—	—			
—	1.5	5	—	2	—	2.6	—	—	—	—	—	—	—	—	—	—	—	—	—	—			
2	2	6	—	2.3	—	3	—	—	—	—	—	—	—	—	—	—	—	—	—	—			
—	2.5	7	—	2.5	—	3.5	—	—	—	—	—	—	—	—	—	—	—	—	—	—			
3	3	8	—	3	—	4	—	—	—	—	—	—	—	—	—	—	—	—	—	—			
4	4	11	—	4	—	5	—	—	—	—	—	—	—	—	—	—	—	—	—	—			
5	5	13	—	4	—	6	10	—	—	—	—	—	—	—	—	—	—	—	—	—			
6	6	15	—	5	—	7	10	—	—	—	—	—	—	—	—	—	—	—	—	—			
7	7	17	—	5	—	7	10	—	—	—	—	—	—	—	—	—	—	—	—	—			
8	8	19	—	6	—	9	11	—	—	—	—	—	—	—	—	—	—	—	—	—			
9	9	20	—	6	—	9	11	—	—	—	—	—	—	—	—	—	—	—	—	—			
00	10	22	—	6	8	10	13	16	22	—	—	—	—	—	—	—	—	—	—	—			
01	12	24	—	6	8	10	13	16	22	—	—	—	—	—	—	—	—	—	—	—			
02	15	28	—	7	8.5	10	13	18	23	—	—	—	—	—	—	—	—	—	—	—			
03	17	30	—	7	8.5	10	13	18	23	—	—	—	—	—	—	—	—	—	—	—			
04	20	37	7	9	11	13	17	23	30	0.3	0.3	0.3	42	8	12	14	16	22	30	40	0.3	0.6	
/22	22	39	7	9	11	13	17	23	30	0.3	0.3	0.3	44	8	12	14	16	22	30	40	0.3	0.6	
05	25	42	7	9	11	13	17	23	30	0.3	0.3	0.3	47	8	12	14	16	22	30	40	0.3	0.6	
/28	28	45	7	9	11	13	17	23	30	0.3	0.3	0.3	52	8	12	15	18	24	32	43	0.3	0.6	
06	30	47	7	9	11	13	17	23	30	0.3	0.3	0.3	55	9	13	16	19	25	34	45	0.3	1	
/32	32	52	7	10	13	15	20	27	36	0.3	0.6	0.6	58	9	13	16	20	26	35	47	0.3	1	
07	35	55	7	10	13	15	20	27	36	0.3	0.6	0.6	62	9	14	17	20	27	36	48	0.3	1	
08	40	62	8	12	14	16	22	30	40	0.3	0.6	0.6	68	9	15	18	21	28	38	50	0.3	1	
09	45	68	8	12	14	16	22	30	40	0.3	0.6	0.6	75	10	16	19	23	30	40	54	0.3	1	
10	50	72	8	12	14	16	22	30	40	0.3	0.6	0.6	80	10	16	19	23	30	40	54	0.6	1	
11	55	80	9	13	16	19	25	34	45	0.3	1	1	90	11	18	22	26	35	46	63	0.6	1.1	
12	60	85	9	13	16	19	25	34	45	0.3	1	1	95	11	18	22	26	35	46	63	0.6	1.1	
13	65	90	9	13	16	19	25	34	45	0.6	1	1	100	11	18	22	26	35	46	63	0.6	1.1	
14	70	100	10	16	19	23	30	40	54	0.6	1	1	110	13	20	24	30	40	54	71	0.6	1.1	
15	75	105	10	16	19	23	30	40	54	0.6	1	1	115	13	20	24	30	40	5				

Appendix table-1: Boundary dimensions of radial bearings (Tapered roller bearings not included)-3

Single row radial ball bearings		67												68		78	
Double row radial ball bearings																	
Cylindrical roller bearings										N28		N38		NN48			
Needle roller bearings														NA48			
Spherical roller bearings																	
Nominal bearing bore diameter <i>d</i>		Diameter series 7						Diameter series 8									
Number	Dimension	Dimension series					Nominal bearing outer diameter <i>D</i>	Dimension series									
		17	27	37	47	17~47		Nominal width <i>B</i>					Nominal width <i>B</i>				
36	180	215	18	—	26	—	1.1	225	14	22	27	34	45	60	80	0.6	1.1
38	190	230	20	—	30	—	1.1	240	16	24	30	37	50	67	90	1	1.5
40	200	240	20	—	30	—	1.1	250	16	24	30	37	50	67	90	1	1.5
44	220	—	—	—	—	—	—	270	16	24	30	37	50	67	90	1	1.5
48	240	—	—	—	—	—	—	300	19	28	36	45	60	80	100	1	2
52	260	—	—	—	—	—	—	320	19	28	36	45	60	80	100	1	2
56	280	—	—	—	—	—	—	350	22	33	42	52	69	95	125	1.1	2
60	300	—	—	—	—	—	—	380	25	38	48	60	80	109	145	1.5	2.1
64	320	—	—	—	—	—	—	400	25	38	48	60	80	109	145	1.5	2.1
68	340	—	—	—	—	—	—	420	25	38	48	60	80	109	145	1.5	2.1
72	360	—	—	—	—	—	—	440	25	38	48	60	80	109	145	1.5	2.1
76	380	—	—	—	—	—	—	480	31	46	60	75	100	136	180	2	2.1
80	400	—	—	—	—	—	—	500	31	46	60	75	100	136	180	2	2.1
84	420	—	—	—	—	—	—	520	31	46	60	75	100	136	180	2	2.1
88	440	—	—	—	—	—	—	540	31	46	60	75	100	136	180	2	2.1
92	460	—	—	—	—	—	—	580	37	56	72	90	118	160	218	2.1	3
96	480	—	—	—	—	—	—	600	37	56	72	90	118	160	218	2.1	3
/500	500	—	—	—	—	—	—	620	37	56	72	90	118	160	218	2.1	3
/530	530	—	—	—	—	—	—	650	37	56	72	90	118	160	218	2.1	3
/560	560	—	—	—	—	—	—	680	37	56	72	90	118	160	218	2.1	3
/600	600	—	—	—	—	—	—	730	42	60	78	98	128	175	236	3	3
/630	630	—	—	—	—	—	—	780	48	69	88	112	150	200	272	3	4
/670	670	—	—	—	—	—	—	820	48	69	88	112	150	200	272	3	4
/710	710	—	—	—	—	—	—	870	50	74	95	118	160	218	290	4	4
/750	750	—	—	—	—	—	—	920	54	78	100	128	170	230	308	4	5
/800	800	—	—	—	—	—	—	980	57	82	106	136	180	243	325	4	5
/850	850	—	—	—	—	—	—	1030	57	82	106	136	180	243	325	4	5
/900	900	—	—	—	—	—	—	1090	60	85	112	140	190	258	345	5	5
/950	950	—	—	—	—	—	—	1150	63	90	118	150	200	272	355	5	5
/1000	1000	—	—	—	—	—	—	1220	71	100	128	165	218	300	400	5	6
/1060	1060	—	—	—	—	—	—	1280	71	100	128	165	218	300	400	5	6
/1120	1120	—	—	—	—	—	—	1360	78	106	140	180	243	325	438	5	6
/1180	1180	—	—	—	—	—	—	1420	78	106	140	180	243	325	438	5	6
/1250	1250	—	—	—	—	—	—	1500	80	112	145	185	250	335	450	6	6
/1320	1320	—	—	—	—	—	—	1600	88	122	165	206	280	375	500	6	6
/1400	1400	—	—	—	—	—	—	1700	95	132	175	224	300	400	545	6	7.5
/1500	1500	—	—	—	—	—	—	1820	—	140	185	243	315	—	—	—	7.5
/1600	1600	—	—	—	—	—	—	1950	—	155	200	265	345	—	—	—	7.5
/1700	1700	—	—	—	—	—	—	2060	—	160	206	272	355	—	—	—	7.5
/1800	1800	—	—	—	—	—	—	2180	—	165	218	290	375	—	—	—	9.5
/1900	1900	—	—	—	—	—	—	2300	—	175	230	300	400	—	—	—	9.5
/2000	2000	—	—	—	—	—	—	2430	—	190	250	325	425	—	—	—	9.5

Appendix table-1: Boundary dimensions of radial bearings (Tapered roller bearings not included)-4 Unit: mm

Single row radial ball bearings		69		79												160		60		70			
Double row radial ball bearings																							
Cylindrical roller bearings		N19		N29		NN39		NN49								N10		N20		NN30		NN40	
Needle roller bearings								NA49		NA59		NA69											
Spherical roller bearings								239		249								230		240			
Nominal bearing bore diameter <i>d</i>		Diameter series 9										Diameter series 0											
Number	Dimension	Dimension series					Nominal bearing outer diameter <i>D</i>	Dimension series															
		09	19	29	39	49		59	69	09	19~39	49~69	Chamfer dimension <i>r</i> 's min		Nominal bearing outer diameter <i>D</i>	Dimension series							
Nominal width <i>B</i>										Chamfer dimension <i>r</i> 's min		Nominal width <i>B</i>										Chamfer dimension <i>r</i> 's min	
36	180	250	22	33	42	52	69	95	125	1.1	2	2	280	31	46	60	74	100	136	180	2	2.1	
38	190	260	22	33	42	52	69	95	125	1.1	2	2	290	31	46	60	75	100	136	180	2	2.1	
40	200	280	25	38	48	60	80	109	145	1.5	2.1	2.1	310	34	51	66	82	109	150	200	2	2.1	
44	220	300	25	38	48	60	80	109	145	1.5	2.1	2.1	340	37	56	72	90	118	160	218	2.1	3	
48	240	320	25	38	48	60	80	109	145	1.5	2.1	2.1	360	37	56	72	92	118	160	218	2.1	3	
52	260	360	31	46	60	75	100	136	180	2	2.1	2.1	400	44	65	82	104	140	190	250	3	4	
56	280	380	31	46	60	75	100	136	180	2	2.1	2.1	420	44	65	82	106	140	190	250	3	4	
60	300	420	37	56	72	90	118	160	218	2.1	3	3	460	50	74	95	118	160	218	290	4	4	
64	320	440	37	56	72	90	118	160	218	2.1	3	3	480	50	74	95	121	160	218	290	4	4	
68	340	460	37	56	72	90	118	160	218	2.1	3	3	520	57	82	106	133	180	243	325	4	5	
72	360	480	37	56	72	90	118	160	218	2.1	3	3	540	57	82	106	134	180	243	325	4	5	
76	380	520	44	65	82	106	140	190	250	3	4	4	560	57	82	106	135	180	243	325	4	5	
80	400	540	44	65	82	106	140	190	250	3	4	4	600	63	90	118	148	200	272	355	5	5	
84	420	560	44	65	82	106	140	190	250	3	4	4	620	63	90	118	150	200	272	355	5	5	
88	440	600	50	74	95	118	160	218	290	4	4	4	650	67	94	122	157	212	280	375	5	6	
92	460	620	50	74	95	118	160	218	290	4	4	4	680	71	100	128	163	218	300	400	5	6	
96	480	650	54	78	100	128	170	230	308	4	5	5	700	71	100	128	165	218	300	400	5	6	
/500	500	670	54	78	100	128	170	230	308	4	5	5	720	71	100	128	167	218	300	400	5	6	
/530	530	710	57	82	106	136	180	243	325	4	5	5	780	80	112	145	185	250	335	450	6	6	
/560	560	750	60	85	112	140	190	258	345	5	5	5	820	82	115	150	195	258	355	462	6	6	
/600	600	800	63	90	118	150	200	272	355	5	5	5	870	85	118	155	200	272	365	488	6	6	
/630	630	850	71	100	128	165	218	300	400	5	6	6	920	92	128	170	212	290	388	515	6	7.5	
/670	670	900	73	103	136	170	230	308	412	5	6	6	980	100	136	180	230	308	425	560	6	7.5	
/710	710	950	78	106	140	180	243	325	438	5	6	6	1030	103	140	185	236	315	438	580	6	7.5	
/750	750	1000	80	112	145	185	250	335	450	6	6	6	1090	109	150	195	250	335	462	615	7.5	7.5	
/800	800	1060	82	115	150	195	258	355	462	6	6	6	1150	112	155	200	258	345	475	630	7.5	7.5	
/850	850	1120	85	118	155	200	272	365	488	6	6	6	1220	118	165	212	272	365	500	670	7.5	7.5	
/900	900	1180	88	122	165	206																	

Appendix table-1: Boundary dimensions of radial bearings (Tapered roller bearings not included)-5

Single row radial ball bearings												52	622	632									
Double row radial ball bearings												12	42	52									
Cylindrical roller bearings		NN31										N2	N22	N32									
Needle roller bearings																							
Spherical roller bearings		231 241										222	232										
Nominal bearing bore diameter <i>d</i>		Diameter series 1										Diameter series 2											
Number	Dimension	Dimension series										Dimension series											
		01	11	21	31	41	51	61	01	11-61	82	02	12	22	32	42	52	62	82	02~62			
		Nominal width <i>B</i>										Nominal width <i>B</i>											
		Chamfer dimension <i>f</i> 's min										Chamfer dimension <i>f</i> 's min											
1	—	—	—	—	—	—	—	—	—	—	—	—	—	—	—	—	—	—	—	—			
2	—	—	—	—	—	—	—	—	—	—	—	—	—	—	—	—	—	—	—	—			
3	3	—	—	—	—	—	—	—	—	—	—	10	2.5	4	—	—	5	—	—	0.1	0.15		
4	4	—	—	—	—	—	—	—	—	—	—	13	3	5	—	—	7	—	—	0.15	0.2		
5	5	15	—	—	—	7	—	—	—	—	0.3	16	3.5	5	—	—	8	—	—	0.15	0.3		
6	6	18	—	—	8	10	—	—	—	—	0.3	19	4	6	—	—	10	—	18	23	0.2	0.3	
7	7	21	—	—	9	11	14	19	25	—	0.3	22	5	7	—	—	11	—	20	27	0.3	0.3	
8	8	23	—	—	10	12	15	20	27	—	0.3	24	5	8	—	—	12	—	21	29	0.3	0.3	
9	9	25	—	—	10	12	16	21	29	—	0.3	26	6	8	—	—	13	—	23	30	0.3	0.3	
00	10	28	—	—	12	14	18	24	32	—	0.3	30	7	9	—	—	14	14.3	—	27	36	0.3	0.6
01	12	30	—	—	12	14	18	24	32	—	0.3	32	7	10	—	—	14	15.9	—	27	36	0.3	0.6
02	15	33	—	—	12	14	18	24	32	—	0.3	35	8	11	—	—	14	15.9	20	27	36	0.3	0.6
03	17	37	—	—	13	15	20	27	36	—	0.6	40	8	12	—	—	16	17.5	22	30	40	0.3	0.6
04	20	44	—	—	15	18	24	32	43	—	0.6	47	9	14	—	—	18	20.6	27	36	48	0.3	1
/22	22	47	—	—	16	19	25	34	45	—	1	50	9	14	—	—	18	20.6	27	36	48	0.3	1
05	25	50	—	—	16	19	25	34	45	—	1	52	10	15	—	—	18	20.6	27	36	48	0.3	1
/28	28	55	—	—	17	20	27	36	48	—	1	58	10	16	—	—	19	23	30	40	54	0.6	1
06	30	58	—	—	18	21	28	38	50	—	1	62	10	16	—	—	20	23.8	32	43	58	0.6	1
/32	32	62	—	—	19	23	30	40	54	—	1	65	11	17	—	—	21	25	33	43	60	0.6	1
07	35	68	—	—	21	25	33	43	60	—	1.1	72	12	17	—	—	23	27	37	50	67	0.6	1.1
08	40	75	—	—	22	26	35	46	63	—	1.1	80	13	18	—	—	23	30.2	40	54	71	0.6	1.1
09	45	80	—	—	22	26	35	46	63	—	1.1	85	13	19	—	—	23	30.2	40	54	71	0.6	1.1
10	50	85	—	—	22	26	35	46	63	—	1.1	90	13	20	—	—	23	30.2	40	54	71	0.6	1.1
11	55	95	—	—	24	30	40	54	71	—	1.1	100	14	21	—	—	25	33.3	45	60	80	0.6	1.5
12	60	100	—	—	24	30	40	54	71	—	1.1	110	16	22	—	—	28	36.5	50	67	90	1	1.5
13	65	110	—	—	27	34	45	60	80	—	1.5	120	18	23	—	—	31	38.1	56	75	100	1	1.5
14	70	115	—	—	27	34	45	60	80	—	1.5	125	18	24	—	—	31	39.7	56	75	100	1	1.5
15	75	125	—	—	30	37	50	67	90	—	1.5	130	18	25	—	—	31	41.3	56	75	100	1	1.5
16	80	130	—	—	30	37	50	67	90	—	1.5	140	19	26	—	—	33	44.4	60	80	109	1	2
17	85	140	—	—	31	41	56	75	100	—	1.5	150	21	28	—	—	36	49.2	65	88	118	1.1	2
18	90	150	—	—	33	45	60	80	109	—	2	160	22	30	—	—	40	52.4	69	95	125	1.1	2
19	95	160	—	—	39	52	65	88	118	—	2	170	24	32	—	—	43	55.6	75	100	136	1.1	2.1
20	100	165	21	30	39	52	65	88	118	1.1	2	180	25	34	—	—	46	60.3	80	109	145	1.5	2.1
21	105	175	22	33	42	56	69	95	125	1.1	2	190	27	36	—	—	50	65.1	85	115	155	1.5	2.1
22	110	180	22	33	42	56	69	95	125	1.1	2	200	28	38	—	—	53	69.8	90	122	160	1.5	2.1
24	120	200	25	38	48	62	80	109	145	1.5	2	215	—	40	42	58	76	95	128	170	—	2.1	
26	130	210	25	38	48	64	80	109	145	1.5	2	230	—	40	46	64	80	100	136	180	—	3	
28	140	225	27	40	50	68	85	115	155	1.5	2.1	250	—	42	50	68	88	109	150	200	—	3	

Appendix table-1: Boundary dimensions of radial bearings (Tapered roller bearings not included)-6 Unit: mm

Single row radial ball bearings												63	623	633										
Double row radial ball bearings												13	43	53										
Cylindrical roller bearings												N3	N23	N33										
Needle roller bearings																								
Spherical roller bearings												213	223											
Nominal bearing bore diameter <i>d</i>		Diameter series 3										Diameter series 4												
Number	Dimension	Dimension series										Dimension series												
		83	03	13	23	33	83	03~33	04	24	Chamfer dimension <i>f</i> 's min													
		Nominal width <i>B</i>										Nominal width <i>B</i>												
		Chamfer dimension <i>f</i> 's min										Chamfer dimension <i>f</i> 's min												
1	—	—	—	—	—	—	—	—	—	—	—	—	—	—	—	—	—	—	—	—	—	—		
2	—	—	—	—	—	—	—	—	—	—	—	—	—	—	—	—	—	—	—	—	—	—		
3	3	—	—	—	—	—	—	—	—	—	—	13	—	5	—	—	7	—	0.2	—	—	—	—	
4	4	—	—	—	—	—	—	—	—	—	—	16	—	5	—	—	9	—	0.3	—	—	—	—	
5	5	15	—	—	—	—	—	—	—	—	—	19	—	6	—	—	10	—	0.3	—	—	—	—	
6	6	18	—	—	—	—	—	—	—	—	—	22	—	7	—	—	11	13	—	0.3	—	—	—	
7	7	21	—	—	—	—	—	—	—	—	—	26	—	9	—	—	13	15	—	0.3	—	—	—	
8	8	23	—	—	—	—	—	—	—	—	—	28	—	9	—	—	13	15	—	0.3	30	10	14	0.6
9	9	25	—	—	—	—	—	—	—	—	—	30	—	10	—	—	14	16	—	0.6	32	11	15	0.6
00	10	28	—	—	—	—	—	—	—	—	—	35	9	11	—	—	17	19	0.3	0.6	37	12	16	0.6
01	12	30	—	—	—	—	—	—	—	—	—	37	9	12	—	—	17	19	0.3	1	42	13	19	1
02	15	33	—	—	—	—	—	—	—	—	—	42	9	13	—	—	17	19	0.3	1	52	15	24	1.1
03	17	37	—	—	—	—	—	—	—	—	—	47	10	14	—	—	19	22.2	0.6	1	62	17	29	1.1
04	20	44	—	—	—	—	—	—	—	—	—	52	10	15	—	—	21	22.2	0.6	1.1	72	19	33	1.1
/22	22	47	—	—	—	—	—	—	—	—	—	56	11	16	—	—	21	25	0.6	1.1	—	—	—	—
05	25	50	—	—	—	—	—	—	—	—	—	62	12	17	—	—	24	25.4	0.6	1.1	80	21	36	1.5
/28	28	55	—	—	—	—	—	—	—	—	—	68	13	18	—	—	24	30	0.6	1.1	—	—	—	—
06	30	58	—	—	—	—	—	—	—	—	—	72	13	19	—	—	27	30.2	0.6	1.1	90	23	40	1.5
/32	32	62	—	—	—	—	—	—	—	—	—	75	14	20	—	—	28	32	0.6	1.1	—	—	—	—
07	35	68	—	—	—	—	—	—	—	—	—	80	14	21	—	—	31	34.9	0.6	1.5	100	25	43	1.5
08	40	75	—	—	—	—	—	—	—	—	—	90	16	23	—	—	33	36.5	1	1.5	110	27	46	2
09	45	80	—	—	—	—	—	—	—	—	—	100	17	25	—	—	36	39.7	1	1.5	120	29	50	2
10	50	85	—	—	—	—	—	—	—	—	—	110	19	27	—	—	40	44.4	1	2	130	31	53	2.1
11	55	95	—	—	—	—	—	—	—	—	—	120	21	29	—	—	43	49.2	1.1	2	140	33	57	2.1
12	60	100	—	—	—	—	—	—	—	—	—	130	22	31	—	—	46	54	1.1	2.1	150	35	60	2.1
13	65	110	—	—	—	—	—	—	—	—	—	140	24	33	—	—	48	58.7	1.1	2.1	160	37	64	2.1
14	70	115	—	—	—	—	—	—	—	—	—	150</												

Appendix table-1: Boundary dimensions of radial bearings (Tapered roller bearings not included)-7

Single row radial ball bearings												62	622	632								
Double row radial ball bearings												12	42	52								
Cylindrical roller bearings		NN31										N2	N22	N32								
Needle roller bearings																						
Spherical roller bearings		231 241										222	232									
Nominal bearing bore diameter <i>d</i>		Diameter series 1										Diameter series 2										
Number	Dimension	Dimension series										Dimension series										
		01	11	21	31	41	51	61	01	11-61	82	02	12	22	32	42	52	62	82	02~62		
		Nominal width <i>B</i>								Chamfer dimension <i>r</i> /s.min	Nominal width <i>B</i>								Chamfer dimension <i>r</i> /s.min			
30	150	250	31	46	60	80	100	136	180	2	2.1	270	—	45	54	73	96	118	160	218	—	3
32	160	270	34	51	66	86	109	150	200	2	2.1	290	—	48	58	80	104	128	175	236	—	3
34	170	280	34	51	66	88	109	150	200	2	2.1	310	—	52	62	86	110	140	190	250	—	4
36	180	300	37	56	72	96	118	160	218	2.1	3	320	—	52	62	86	112	140	190	250	—	4
38	190	320	42	60	78	104	128	175	236	3	3	340	—	55	65	92	120	150	200	272	—	4
40	200	340	44	65	82	112	140	190	250	3	3	360	—	58	70	98	128	160	218	290	—	4
44	220	370	48	69	88	120	150	200	272	3	4	400	—	65	78	108	144	180	243	325	—	4
48	240	400	50	74	95	128	160	218	290	4	4	440	—	72	85	120	160	200	272	355	—	4
52	260	440	57	82	106	144	180	243	325	4	4	480	—	80	90	130	174	218	300	400	—	5
56	280	460	57	82	106	146	180	243	325	4	5	500	—	80	90	130	176	218	300	400	—	5
60	300	500	63	90	118	160	200	272	355	5	5	540	—	85	98	140	192	243	325	438	—	5
64	320	540	71	100	128	176	218	300	400	5	5	580	—	92	105	150	208	258	355	462	—	5
68	340	580	78	106	140	190	243	325	438	5	5	620	—	92	118	165	224	280	375	500	—	6
72	360	600	78	106	140	192	243	325	438	5	5	650	—	95	122	170	232	290	388	515	—	6
76	380	620	78	106	140	194	243	325	438	5	5	680	—	95	132	175	240	300	400	545	—	6
80	400	650	80	112	145	200	250	335	450	6	6	720	—	103	140	185	256	315	438	580	—	6
84	420	700	88	122	165	224	280	375	500	6	6	760	—	109	150	195	272	335	462	615	—	7.5
88	440	720	88	122	165	226	280	375	500	6	6	790	—	112	155	200	280	345	475	630	—	7.5
92	460	760	95	132	175	240	300	400	545	6	7.5	830	—	118	165	212	296	365	500	670	—	7.5
96	480	790	100	136	180	248	308	425	560	6	7.5	870	—	125	170	224	310	388	530	710	—	7.5
/500	500	830	106	145	190	264	325	450	600	7.5	7.5	920	—	136	185	243	336	412	560	750	—	7.5
/530	530	870	109	150	195	272	335	462	615	7.5	7.5	980	—	145	200	258	355	450	600	—	—	9.5
/560	560	920	115	160	206	280	355	488	650	7.5	7.5	1030	—	150	206	272	365	475	630	—	—	9.5
/600	600	980	122	170	218	300	375	515	690	7.5	7.5	1090	—	155	212	280	388	488	670	—	—	9.5
/630	630	1030	128	175	230	315	400	545	710	7.5	7.5	1150	—	165	230	300	412	515	710	—	—	12
/670	670	1090	136	185	243	336	412	560	750	7.5	7.5	1220	—	175	243	315	438	545	750	—	—	12
/710	710	1150	140	195	250	345	438	600	800	9.5	9.5	1280	—	180	250	325	450	560	775	—	—	12
/750	750	1220	150	206	272	365	475	630	—	9.5	9.5	1360	—	195	265	345	475	615	825	—	—	15
/800	800	1280	155	212	272	375	475	650	—	9.5	9.5	1420	—	200	272	355	488	615	—	—	—	15
/850	850	1360	165	224	290	400	500	690	—	12	12	1500	—	206	280	375	515	650	—	—	—	15
/900	900	1420	165	230	300	412	515	710	—	12	12	1580	—	218	300	388	515	670	—	—	—	15
/950	950	1500	175	243	315	438	545	750	—	12	12	1660	—	230	315	412	530	710	—	—	—	15
/1000	1000	1580	185	258	335	462	580	775	—	12	12	1750	—	243	330	425	560	750	—	—	—	15
/1060	1060	1660	190	265	345	475	600	800	—	12	15	—	—	—	—	—	—	—	—	—	—	—
/1120	1120	1750	—	280	365	475	630	—	—	15	—	—	—	—	—	—	—	—	—	—	—	—
/1180	1180	1850	—	290	388	500	670	—	—	15	—	—	—	—	—	—	—	—	—	—	—	—
/1250	1250	1950	—	308	400	530	710	—	—	15	—	—	—	—	—	—	—	—	—	—	—	—
/1320	1320	2060	—	325	425	560	750	—	—	15	—	—	—	—	—	—	—	—	—	—	—	—
/1400	1400	2180	—	345	450	580	775	—	—	19	—	—	—	—	—	—	—	—	—	—	—	—
/1500	1500	2300	—	355	462	600	800	—	—	19	—	—	—	—	—	—	—	—	—	—	—	—

Appendix table-1: Boundary dimensions of radial bearings (Tapered roller bearings not included)-8 Unit: mm

Single row radial ball bearings												63	623	633			
Double row radial ball bearings												13	43	53			
Cylindrical roller bearings												N3	N23	N33			
Needle roller bearings																	
Spherical roller bearings												213	223				
Nominal bearing bore diameter <i>d</i>		Diameter series 3										Diameter series 4					
Number	Dimension	Dimension series										Dimension series					
		83	03	13	23	33	83	03~33	04	24	Chamfer dimension <i>r</i> /s.min						
		Nominal width <i>B</i>								Chamfer dimension <i>r</i> /s.min	Nominal width <i>B</i>		Chamfer dimension <i>r</i> /s.min				
30	150	250	320	—	65	75	108	128	—	4	380	85	138	5			
32	160	270	340	—	68	79	114	136	—	4	400	88	142	5			
34	170	280	360	—	72	84	120	140	—	4	420	92	145	5			
36	180	300	380	—	75	88	126	150	—	4	440	95	150	6			
38	190	320	400	—	78	92	132	155	—	5	460	98	155	6			
40	200	340	420	—	80	97	138	165	—	5	480	102	160	6			
44	220	370	460	—	88	106	145	180	—	5	540	115	180	6			
48	240	400	500	—	95	114	155	195	—	5	580	122	190	6			
52	260	440	540	—	102	123	165	206	—	6	620	132	206	7.5			
56	280	460	580	—	108	132	175	224	—	6	670	140	224	7.5			
60	300	500	620	—	109	140	185	236	—	7.5	710	150	236	7.5			
64	320	540	670	—	112	155	200	258	—	7.5	750	155	250	9.5			
68	340	580	710	—	118	165	212	272	—	7.5	800	164	265	9.5			
72	360	600	750	—	125	170	224	290	—	7.5	850	180	280	9.5			
76	380	620	780	—	128	175	230	300	—	7.5	900	190	300	9.5			
80	400	650	820	—	136	185	243	308	—	7.5	950	200	315	12			
84	420	700	850	—	136	190	250	315	—	9.5	980	206	325	12			
88	440	720	900	—	145	200	265	345	—	9.5	1030	212	335	12			
92	460	760	950	—	155	212	280	365	—	9.5	1060	218	345	12			
96	480	790	980	—	160	218	290	375	—	9.5	1120	230	365	15			
/500	500	830	1030	—	170	230	300	388	—	12	1150	236	375	15			
/530	530	870	1090	—	180	243	325	412	—	12	1220	250	400	15			
/560	560	920	1150	—	190	258	335	438	—	12	1280	258	412	15			
/600	600	980	1220	—	200	272	355	462	—	15	1360	272	438	15			
/630	630	1030	1280	—	206	280	375	488	—	15	1420	280	450	15			
/670	670	1090	1360	—	218	300	400	515	—	15	1500	290	475	15			
/710	710	1150	1420	—	224	308	412	530	—	15	—	—	—	—			
/750	750	1220	1500	—	236	325	438	560	—	15	—	—	—	—			
/800	800	1280	1600	—	258	355	462	600	—	15	—	—	—	—			
/850	850	1360	1700	—	272	375	488	630	—	19	—	—	—	—			
/900	900	1420	1780	—	280	388	500	650	—	19	—	—	—	—			
/950	950	1500	1850	—	290	400											

Appendix table-2: Boundary dimensions of tapered roller bearing-1

Tapered roller bearings	329										320X					330						
	Bore diameter No.	Bearing bore diameter	Bearing outer diameter	Diameter series 9						Bearing outer diameter	Diameter series 0				Bearing outer diameter	Diameter series 0						
				Dimension series 29							Dimension series 20					Dimension series 30						
				Assembly width	Inner ring width	Outer ring width	Chamfer dimension		r(min.)		Assembly width	Inner ring width	Outer ring width	Chamfer dimension		r(min.)	Assembly width	Inner ring width	Outer ring width	Chamfer dimension		
			Inner ring	Outer ring	Inner ring	Outer ring	Inner ring	Outer ring		Inner ring	Outer ring	Inner ring	Outer ring	Inner ring	Outer ring		Inner ring	Outer ring				
	d	D	T	B	C	r(min.)	D	T	B	C	r(min.)	D	T	B	C	r(min.)	D	T	B	C	r(min.)	
02	15	—	—	—	—	—	—	—	—	—	—	—	—	—	—	—	—	—	—	—	—	—
03	17	—	—	—	—	—	—	—	—	—	—	—	—	—	—	—	—	—	—	—	—	—
04	20	—	—	—	—	—	—	42	15	15	12	0.6	0.6	—	—	—	—	—	—	—	—	—
/22	22	—	—	—	—	—	—	44	15	15	11.5	0.6	0.6	—	—	—	—	—	—	—	—	—
05	25	—	—	—	—	—	—	47	15	15	11.5	0.6	0.6	47	17	17	14	0.6	0.6	—	—	—
/28	28	—	—	—	—	—	—	52	16	16	12	1	1	—	—	—	—	—	—	—	—	—
06	30	47	12	12	9	0.3	0.3	55	17	17	13	1	1	55	20	20	16	1	1	—	—	—
/32	32	—	—	—	—	—	—	58	17	17	13	1	1	—	—	—	—	—	—	—	—	—
07	35	55	14	14	11.5	0.6	0.6	62	18	14	1	1	62	21	21	17	1	1	—	—	—	—
08	40	62	15	15	12	0.6	0.6	68	19	19	14.5	1	1	68	22	22	18	1	1	—	—	—
09	45	68	15	15	12	0.6	0.6	75	20	20	15.5	1	1	75	24	24	19	1	1	—	—	—
10	50	72	15	15	12	0.6	0.6	80	20	20	15.5	1	1	80	24	24	19	1	1	—	—	—
11	55	80	17	17	14	1	1	90	23	23	17.5	1.5	1.5	90	27	27	21	1.5	1.5	—	—	—
12	60	85	17	17	14	1	1	95	23	23	17.5	1.5	1.5	95	27	27	21	1.5	1.5	—	—	—
13	65	90	17	17	14	1	1	100	23	23	17.5	1.5	1.5	100	27	27	21	1.5	1.5	—	—	—
14	70	100	20	20	16	1	1	110	25	25	19	1.5	1.5	110	31	31	25.5	1.5	1.5	—	—	—
15	75	105	20	20	16	1	1	115	25	25	19	1.5	1.5	115	31	31	25.5	1.5	1.5	—	—	—
16	80	110	20	20	16	1	1	125	29	29	22	1.5	1.5	125	36	36	29.5	1.5	1.5	—	—	—
17	85	120	23	23	18	1.5	1.5	130	29	29	22	1.5	1.5	130	36	36	29.5	1.5	1.5	—	—	—
18	90	125	23	23	18	1.5	1.5	140	32	32	24	2	1.5	140	39	39	32.5	2	1.5	—	—	—
19	95	130	23	23	18	1.5	1.5	145	32	32	24	2	1.5	145	39	39	32.5	2	1.5	—	—	—
20	100	140	25	25	20	1.5	1.5	150	32	32	24	2	1.5	150	39	39	32.5	2	1.5	—	—	—
21	105	145	25	25	20	1.5	1.5	160	35	35	26	2.5	2	160	43	43	34	2.5	2	—	—	—
22	110	150	25	25	20	1.5	1.5	170	38	38	29	2.5	2	170	47	47	37	2.5	2	—	—	—
24	120	165	29	29	23	1.5	1.5	180	38	38	29	2.5	2	180	48	48	38	2.5	2	—	—	—
26	130	180	32	32	25	2	1.5	200	45	45	34	2.5	2	200	55	55	43	2.5	2	—	—	—
28	140	190	32	32	25	2	1.5	210	45	45	34	2.5	2	210	56	56	44	2.5	2	—	—	—
30	150	210	38	38	30	2.5	2	225	48	48	36	3	2.5	225	59	59	46	3	2.5	—	—	—
32	160	220	38	38	30	2.5	2	240	51	51	38	3	2.5	—	—	—	—	—	—	—	—	—
34	170	230	38	38	30	2.5	2	260	57	57	43	3	2.5	—	—	—	—	—	—	—	—	—
36	180	250	45	45	34	2.5	2	280	64	64	48	3	2.5	—	—	—	—	—	—	—	—	—
38	190	260	45	45	34	2.5	2	290	64	64	48	3	2.5	—	—	—	—	—	—	—	—	—
40	200	280	51	51	39	3	2.5	310	70	70	53	3	2.5	—	—	—	—	—	—	—	—	—
44	220	300	51	51	39	3	2.5	340	76	76	57	4	3	—	—	—	—	—	—	—	—	—
48	240	320	51	51	39	3	2.5	360	76	76	57	4	3	—	—	—	—	—	—	—	—	—
52	260	360	63.5	63.5	48	3	2.5	400	87	87	65	5	4	—	—	—	—	—	—	—	—	—
56	280	380	63.5	63.5	48	3	2.5	420	87	87	65	5	4	—	—	—	—	—	—	—	—	—
60	300	420	76	76	57	4	3	460	100	100	74	5	4	—	—	—	—	—	—	—	—	—
64	320	440	76	76	57	4	3	480	100	100	74	5	4	—	—	—	—	—	—	—	—	—
68	340	460	76	76	57	4	3	—	—	—	—	—	—	—	—	—	—	—	—	—	—	—
72	360	480	76	76	57	4	3	—	—	—	—	—	—	—	—	—	—	—	—	—	—	—

Appendix table-2: Boundary dimensions of tapered roller bearing-2

Unit: mm

Tapered roller bearings	331										302					322									
	Bore diameter No.	Bearing bore diameter	Bearing outer diameter	Diameter series 1						Bearing outer diameter	Diameter series 2				Bearing outer diameter	Diameter series 2									
				Dimension series 31							Dimension series 02					Dimension series 22									
				Assembly width	Inner ring width	Outer ring width	Chamfer dimension		r(min.)		Assembly width	Inner ring width	Outer ring width	Chamfer dimension		r(min.)	Assembly width	Inner ring width	Outer ring width	Chamfer dimension					
			Inner ring	Outer ring	Inner ring	Outer ring	Inner ring	Outer ring		Inner ring	Outer ring	Inner ring	Outer ring	Inner ring	Outer ring		Inner ring	Outer ring							
	d	D	T	B	C	r(min.)	D	T	B	C	r(min.)	D	T	B	C	r(min.)	D	T	B	C	r(min.)				
02	15	—	—	—	—	—	—	—	—	—	—	—	—	—	—	—	—	—	—	—	—	—			
03	17	—	—	—	—	—	—	40	13.25	12	11	1	1	40	17.25	16	14	1	1	40	17.25	16	14	1	1
04	20	—	—	—	—	—	—	47	15.25	14	12	1	1	47	19.25	18	15	1	1	47	19.25	18	15	1	1
/22	22	—	—	—	—	—	—	—	—	—	—	—	—	—	—	—	—	—	—	—	—	—	—	—	—
05	25	—	—	—	—	—	—	52	16.25	15	13	1	1	52	19.25	18	16	1	1	52	19.25	18	16	1	1
/28	28	—	—	—	—	—	—	—	—	—	—	—	—	—	—	—	—	—	—	—	—	—	—	—	—
06	30	47	12	12	9	0.3	0.3	62	17.25	16	14	1	1	62	21.25	20	17	1	1	62	21.25	20	17	1	1
/32	32	—	—	—	—	—	—	65	18.25	17	15	1	1	—	—	—	—	—	—	—	—	—	—	—	—
07	35	55	14	14	11.5	0.6	0.6	72	18.25	17	15	1.5	1.5	72	24.25	23	19	1.5	1.5	72	24.25	23	19	1.5	1.5
08	40	62	15	15	12	0.6	0.6	80	19.75	18	16	1.5	1.5	80	24.75	23	19	1.5	1.5	80	24.75	23	19	1.5	1.5
09	45	68	15	15	12	0.6	0.6	85	20.75	19	16	1.5	1.5	85	24.75	23	19	1.5	1.5	85	24.75	23	19	1.5	1.5
10	50	72	15	15	12	0.6	0.6	90	21.75	20	17	1.5	1.5	90	24.75	23	19	1.5	1.5	90	24.75	23	19	1.5	1.5
11	55	80	17	17	14	1	1	100	22.75	21	18	2	1.5	100	26.75	25	21	2	1.5	100	26.75	25	21	2	1.5
12	60	85	17	17	14	1	1	110	23.75	22	19	2	1.5	110	29.75	28	24	2	1.5	110	29.75	28	24	2	1.5
13	65	90	17	17	14	1	1	120	24.75	23	20	2	1.5	120	32.75	31	27	2	1.5	120	32.75	31	27	2	1.5
14	70	100	20	20	16	1	1	125	26.25	24	21	2	1.5	125	33.25	31	27	2	1.5	125	33.25	31	27	2	1.5
15	75	105	20	20	16	1	1	130	27.25	25	22	2	1.5	130	33.25	31	27	2	1.5	130	33.25	31	27	2	1.5
16	80	110	20	20	16	1	1	140	28.25	26	22	2.5	2	140	35.25	33	28	2.5	2	140	35.25	33	28	2.5	2
17	85	120	23	23	18	1.5	1.5	150	30.5	28	24	2.5	2	150	38.5	36	30	2.5	2	150	38.5	36	30	2.5	2
18	90	125	23	23	18	1.5	1.5	160	32.5	30	26	2.5	2	160	42.5	40	34	2.5	2	160	42.5	40	34	2.5	2
19	95	130	23	23	18	1.5	1.5	170	34.5	32	27	3	2.5	170	45.5	43	37	3	2.5	170	45.5	43	37	3	2.5
20	100	140																							

Appendix table-2: Boundary dimensions of tapered roller bearing-3

Tapered roller bearings	332								303					303D						
	Bore diameter No.	Bearing bore diameter	Bearing outer diameter	Diameter series 2				Bearing outer diameter	Diameter series 3				Bearing outer diameter	Diameter series 3						
				Dimension series 32					Dimension series 03					Dimension series 03						
				Assembly width	Inner ring width	Outer ring width	Chamfer dimension		Assembly width	Inner ring width	Outer ring width	Chamfer dimension		Assembly width	Inner ring width	Outer ring width	Chamfer dimension			
							Inner ring					Outer ring					Inner ring	Outer ring	Inner ring	Outer ring
<i>d</i>	<i>D</i>	<i>T</i>	<i>B</i>	<i>C</i>	<i>r</i> (min.)	<i>D</i>	<i>T</i>	<i>B</i>	<i>C</i>	<i>r</i> (min.)	<i>D</i>	<i>T</i>	<i>B</i>	<i>C</i>	<i>r</i> (min.)					
02	15	—	—	—	—	—	42	14.25	13	11	1	1	—	—	—	—	—			
03	17	—	—	—	—	—	47	15.25	14	12	1	1	—	—	—	—	—			
04	20	—	—	—	—	—	52	16.25	15	13	1.5	1.5	—	—	—	—	—			
/22	22	—	—	—	—	—	—	—	—	—	—	—	—	—	—	—	—			
05	25	52	22	22	18	1	62	18.25	17	15	1.5	1.5	62	18.25	17	13	1.5	1.5		
/28	28	58	24	24	19	1	—	—	—	—	—	—	—	—	—	—	—	—		
06	30	62	25	25	19.5	1	72	20.75	19	16	1.5	1.5	72	20.75	19	14	1.5	1.5		
/32	32	65	26	26	20.5	1	—	—	—	—	—	—	—	—	—	—	—	—		
07	35	72	28	28	22	1.5	80	22.75	21	18	2	1.5	80	22.75	21	15	2	1.5		
08	40	80	32	32	25	1.5	90	25.25	23	20	2	1.5	90	25.25	23	17	2	1.5		
09	45	85	32	32	25	1.5	100	27.25	25	22	2	1.5	100	27.25	25	18	2	1.5		
10	50	90	32	32	24.5	1.5	110	29.25	27	23	2.5	2	110	29.25	27	19	2.5	2		
11	55	100	35	35	27	2	120	31.5	29	25	2.5	2	120	31.5	29	21	2.5	2		
12	60	110	38	38	29	2	130	33.5	31	26	3	2.5	130	33.5	31	22	3	2.5		
13	65	120	41	41	32	2	140	36	33	28	3	2.5	140	36	33	23	3	2.5		
14	70	125	41	41	32	2	150	38	35	30	3	2.5	150	38	35	25	3	2.5		
15	75	130	41	41	31	2	160	40	37	31	3	2.5	160	40	37	26	3	2.5		
16	80	140	46	46	35	2.5	170	42.5	39	33	3	2.5	170	42.5	39	27	3	2.5		
17	85	150	49	49	37	2.5	180	44.5	41	34	4	3	180	44.5	41	28	4	3		
18	90	160	55	55	42	2.5	190	46.5	43	36	4	3	190	46.5	43	30	4	3		
19	95	170	58	58	44	3	200	49.5	45	38	4	3	200	49.5	45	32	4	3		
20	100	180	63	63	48	3	215	51.5	47	39	4	3	—	—	—	—	—	—		
21	105	190	68	68	52	3	225	53.5	49	41	4	3	—	—	—	—	—	—		
22	110	—	—	—	—	—	240	54.5	50	42	4	3	—	—	—	—	—	—		
24	120	—	—	—	—	—	260	59.5	55	46	4	3	—	—	—	—	—	—		
26	130	—	—	—	—	—	280	63.75	58	49	5	4	—	—	—	—	—	—		
28	140	—	—	—	—	—	300	67.75	62	53	5	4	—	—	—	—	—	—		
30	150	—	—	—	—	—	320	72	65	55	5	4	—	—	—	—	—	—		
32	160	—	—	—	—	—	340	75	68	58	5	4	—	—	—	—	—	—		
34	170	—	—	—	—	—	360	80	72	62	5	4	—	—	—	—	—	—		
36	180	—	—	—	—	—	—	—	—	—	—	—	—	—	—	—	—	—		
38	190	—	—	—	—	—	—	—	—	—	—	—	—	—	—	—	—	—		
40	200	—	—	—	—	—	—	—	—	—	—	—	—	—	—	—	—	—		
44	220	—	—	—	—	—	—	—	—	—	—	—	—	—	—	—	—	—		
48	240	—	—	—	—	—	—	—	—	—	—	—	—	—	—	—	—	—		
52	260	—	—	—	—	—	—	—	—	—	—	—	—	—	—	—	—	—		
56	280	—	—	—	—	—	—	—	—	—	—	—	—	—	—	—	—	—		
60	300	—	—	—	—	—	—	—	—	—	—	—	—	—	—	—	—	—		
64	320	—	—	—	—	—	—	—	—	—	—	—	—	—	—	—	—	—		
68	340	—	—	—	—	—	—	—	—	—	—	—	—	—	—	—	—	—		
72	360	—	—	—	—	—	—	—	—	—	—	—	—	—	—	—	—	—		

Appendix table-2: Boundary dimensions of tapered roller bearing-4 Unit: mm

Tapered roller bearings	313								323					
	Bore diameter No.	Bearing bore diameter	Bearing outer diameter	Diameter series 3				Bearing outer diameter	Diameter series 3					
				Dimension series 13					Dimension series 23					
				Assembly width	Inner ring width	Outer ring width	Chamfer dimension		Assembly width	Inner ring width	Outer ring width	Chamfer dimension		
							Inner ring					Outer ring	Inner ring	Outer ring
<i>d</i>	<i>D</i>	<i>T</i>	<i>B</i>	<i>C</i>	<i>r</i> (min.)	<i>D</i>	<i>T</i>	<i>B</i>	<i>C</i>	<i>r</i> (min.)				
02	15	—	—	—	—	—	—	—	—	—	—	—	—	
03	17	—	—	—	—	—	47	20.25	19	16	1	1	—	
04	20	—	—	—	—	—	52	22.25	21	18	1.5	1.5	—	
/22	22	—	—	—	—	—	—	—	—	—	—	—	—	
05	25	—	—	—	—	—	62	25.25	24	20	1.5	1.5	—	
/28	28	—	—	—	—	—	—	—	—	—	—	—	—	
06	30	—	—	—	—	—	72	28.75	27	23	1.5	1.5	—	
/32	32	—	—	—	—	—	—	—	—	—	—	—	—	
07	35	—	—	—	—	—	80	32.75	31	25	2	1.5	—	
08	40	—	—	—	—	—	90	35.25	33	27	2	1.5	—	
09	45	—	—	—	—	—	100	38.25	36	30	2	1.5	—	
10	50	—	—	—	—	—	110	42.25	40	33	2.5	2	—	
11	55	—	—	—	—	—	120	45.5	43	35	2.5	2	—	
12	60	—	—	—	—	—	130	48.5	46	37	3	2.5	—	
13	65	—	—	—	—	—	140	51	48	39	3	2.5	—	
14	70	—	—	—	—	—	150	54	51	42	3	2.5	—	
15	75	—	—	—	—	—	160	58	55	45	3	2.5	—	
16	80	—	—	—	—	—	170	61.5	58	48	3	2.5	—	
17	85	—	—	—	—	—	180	63.5	60	49	4	3	—	
18	90	—	—	—	—	—	190	67.5	64	53	4	3	—	
19	95	—	—	—	—	—	200	71.5	67	55	4	3	—	
20	100	215	56.5	51	35	4	215	77.5	73	60	4	3	—	
21	105	225	58	53	36	4	225	81.5	77	63	4	3	—	
22	110	240	63	57	38	4	240	84.5	80	65	4	3	—	
24	120	260	68	62	42	4	260	90.5	86	69	4	3	—	
26	130	280	72	66	44	5	4	—	—	—	—	—	—	
28	140	300	77	70	47	5	4	—	—	—	—	—	—	
30	150	320	82	75	50	5	4	—	—	—	—	—	—	
32	160	—	—	—	—	—	—	—	—	—	—	—	—	
34	170	—	—	—	—	—	—	—	—	—	—	—	—	
36	180	—	—	—	—	—	—	—	—	—	—	—	—	
38	190	—	—	—	—	—	—	—	—	—	—	—	—	
40	200	—	—	—	—	—	—	—	—	—	—	—	—	
44	220	—	—	—	—	—	—	—	—	—	—	—	—	
48	240	—	—	—	—	—	—	—	—	—	—	—	—	
52	260	—	—	—	—	—	—	—	—	—	—	—	—	
56	280	—	—	—	—	—	—	—	—	—	—	—	—	
60	300	—	—	—	—	—	—	—	—	—	—	—	—	
64	320	—	—	—	—	—	—	—	—	—	—	—	—	
68	340	—	—	—	—	—	—	—	—	—	—	—	—	
72	360	—	—	—	—	—	—	—	—	—	—	—	—	

Appendix table-3: Boundary dimensions of single direction thrust bearings-1

Thrust ball bearings	511										512				522				Spherical roller thrust bearings	
	292																			
	Bore diameter code	Diameter series 0					Diameter series 1					Diameter series 2								
		Nominal bearing outer diameter	Dimension series			Nominal bearing outer diameter	Dimension series			Dimension series				Chamfer dimension	Chamfer dimension	Chamfer dimension				
70			90	10	71		91	11	72	92	12	22	22							
4	4	12	4	—	6	0.3	—	—	—	—	—	16	6	—	8	—	—	—	0.3	—
6	6	16	5	—	7	0.3	—	—	—	—	—	20	6	—	9	—	—	—	0.3	—
8	8	18	5	—	7	0.3	—	—	—	—	—	22	6	—	9	—	—	—	0.3	—
00	10	20	5	—	7	0.3	24	6	—	9	0.3	26	7	—	11	—	—	—	0.6	—
01	12	22	5	—	7	0.3	26	6	—	9	0.3	28	7	—	11	—	—	—	0.6	—
02	15	26	5	—	7	0.3	28	6	—	9	0.3	32	8	—	12	22	10	5	0.6	0.3
03	17	28	5	—	7	0.3	30	6	—	9	0.3	35	8	—	12	—	—	—	0.6	—
04	20	32	6	—	8	0.3	35	7	—	10	0.3	40	9	—	14	26	15	6	0.6	0.3
05	25	37	6	—	8	0.3	42	8	—	11	0.6	47	10	—	15	28	20	7	0.6	0.3
06	30	42	6	—	8	0.3	47	8	—	11	0.6	52	10	—	16	29	25	7	0.6	0.3
07	35	47	6	—	8	0.3	52	8	—	12	0.6	62	12	—	18	34	30	8	1	0.3
08	40	52	6	—	9	0.3	60	9	—	13	0.6	68	13	—	19	36	30	9	1	0.6
09	45	60	7	—	10	0.3	65	9	—	14	0.6	73	13	—	20	37	35	9	1	0.6
10	50	65	7	—	10	0.3	70	9	—	14	0.6	78	13	—	22	39	40	9	1	0.6
11	55	70	7	—	10	0.3	78	10	—	16	0.6	90	16	21	25	45	45	10	1	0.6
12	60	75	7	—	10	0.3	85	11	—	17	1	95	16	21	26	46	50	10	1	0.6
13	65	80	7	—	10	0.3	90	11	—	18	1	100	16	21	27	47	55	10	1	0.6
14	70	85	7	—	10	0.3	95	11	—	18	1	105	16	21	27	47	55	10	1	1
15	75	90	7	—	10	0.3	100	11	—	19	1	110	16	21	27	47	60	10	1	1
16	80	95	7	—	10	0.3	105	11	—	19	1	115	16	21	28	48	65	10	1	1
17	85	100	7	—	10	0.3	110	11	—	19	1	125	18	24	31	55	70	12	1	1
18	90	105	7	—	10	0.3	120	14	—	22	1	135	20	27	35	62	75	14	1.1	1
20	100	120	9	—	14	0.6	135	16	21	25	1	150	23	30	38	67	85	15	1.1	1
22	110	130	9	—	14	0.6	145	16	21	25	1	160	23	30	38	67	95	15	1.1	1
24	120	140	9	—	14	0.6	155	16	21	25	1	170	23	30	39	68	100	15	1.1	1.1
26	130	150	9	—	14	0.6	170	18	24	30	1	190	27	36	45	80	110	18	1.5	1.1
28	140	160	9	—	14	0.6	180	18	24	31	1	200	27	36	46	81	120	18	1.5	1.1
30	150	170	9	—	14	0.6	190	18	24	31	1	215	29	39	50	89	130	20	1.5	1.1
32	160	180	9	—	14	0.6	200	18	24	31	1	225	29	39	51	90	140	20	1.5	1.1
34	170	190	9	—	14	0.6	215	20	27	34	1.1	240	32	42	55	97	150	21	1.5	1.1
36	180	200	9	—	14	0.6	225	20	27	34	1.1	250	32	42	56	98	150	21	1.5	2
38	190	215	11	—	17	1	240	23	30	37	1.1	270	36	48	62	109	160	24	2	2
40	200	225	11	—	17	1	250	23	30	37	1.1	280	36	48	62	109	170	24	2	2
44	220	250	14	—	22	1	270	23	30	37	1.1	300	36	48	63	110	190	24	2	2
48	240	270	14	—	22	1	300	27	36	45	1.5	340	45	60	78	—	—	—	2.1	—
52	260	290	14	—	22	1	320	27	36	45	1.5	360	45	60	79	—	—	—	2.1	—
56	280	310	14	—	22	1	350	32	42	53	1.5	380	45	60	80	—	—	—	2.1	—
60	300	340	18	24	30	1	380	36	48	62	2	420	54	73	95	—	—	—	3	—
64	320	360	18	24	30	1	400	36	48	63	2	440	54	73	95	—	—	—	3	—

Note: 1. Dimension series 22, 23, and 24 are double row bearing series. For double row bearings, d2 becomes the nominal bearing bore diameter.
 2. For the outer diameter of the shaft raceway washer and the inner diameter of the housing raceway washer, see the dimension table of thrust bearings.

Appendix table-3: Boundary dimensions of single direction thrust bearings-2

Unit: mm

Thrust ball bearings	513										523				514				524				Spherical roller thrust bearings	
	293																							
	Bore diameter code	Diameter series 3					Diameter series 4					Diameter series 5												
		Nominal bearing outer diameter	Dimension series			Nominal bearing outer diameter	Dimension series			Dimension series				Chamfer dimension	Chamfer dimension	Chamfer dimension	Nominal bearing outer diameter	Dimension series			Nominal bearing outer diameter	Bore diameter		
73			93	13	23		23	74	94	14	24	24	95					95						
20	7	—	11	—	—	0.6	—	—	—	—	—	—	—	—	—	—	—	—	—	—	4	4		
24	8	—	12	—	—	0.6	—	—	—	—	—	—	—	—	—	—	—	—	—	—	6	6		
26	8	—	12	—	—	0.6	—	—	—	—	—	—	—	—	—	—	—	—	—	—	8	8		
30	9	—	14	—	—	0.6	—	—	—	—	—	—	—	—	—	—	—	—	—	—	10	00		
32	9	—	14	—	—	0.6	—	—	—	—	—	—	—	—	—	—	—	—	—	—	12	01		
37	10	—	15	—	—	0.6	—	—	—	—	—	—	—	—	—	—	—	—	—	—	15	02		
40	10	—	16	—	—	0.6	—	—	—	—	—	—	—	—	—	—	—	—	—	—	15	03		
47	12	—	18	—	—	1	—	—	—	—	—	—	—	—	—	—	—	—	—	60	24	1	20	04
52	12	—	18	34	20	8	1	0.3	60	16	21	24	45	15	11	1	0.6	73	29	1.1	25	05		
60	14	—	21	38	25	9	1	0.3	70	18	24	28	52	20	12	1	0.6	85	34	1.1	30	06		
68	15	—	24	44	30	10	1	0.3	80	20	27	32	59	25	14	1.1	0.6	100	39	1.1	35	07		
78	17	22	26	49	30	12	1	0.6	90	23	30	36	65	30	15	1.1	0.6	110	42	1.5	40	08		
85	18	24	28	52	35	12	1	0.6	100	25	34	39	72	35	17	1.1	0.6	120	45	2	45	09		
95	20	27	31	58	40	14	1.1	0.6	110	27	36	43	78	40	18	1.5	0.6	135	51	2	50	10		
105	23	30	35	64	45	15	1.1	0.6	120	29	39	48	87	45	20	1.5	0.6	150	58	2.1	55	11		
110	23	30	35	64	50	15	1.1	0.6	130	32	42	51	93	50	21	1.5	0.6	160	60	2.1	60	12		
115	23	30	36	65	55	15	1.1	0.6	140	34	45	56	101	50	23	2	1	170	63	2.1	65	13		
125	25	34	40	72	55	16	1.1	1	150	36	48	60	107	55	24	2	1	180	67	3	70	14		
135	27	36	44	79	60	18	1.5	1	160	38	51	65	115	60	26	2	1	190	69	3	75	15		
140	27	36	44	79	65	18	1.5	1	170	41	54	68	120	65	27	2.1	1	200	73	3	80	16		
150	29	39	49	87	70	19	1.5	1	180	42	58	72	128	65	29	2.1	1.1	215	78	4	85	17		
155	29	39	50	88	75	19	1.5	1	190	45	60	77	135	70	30	2.1	1.1	225	82	4	90	18		
170	32	42	55	97	85	21	1.5	1	210	50	67	85	150	80	33	3								

Appendix table-3: Boundary dimensions of single direction thrust bearings-3

Thrust ball bearings		511									
Spherical roller thrust bearings											
Bore diameter code	Nominal bearing bore diameter d	Diameter series 0					Diameter series 1				
		Nominal bearing outer diameter D	Dimension series			Chamfer dimension r (min.)	Nominal bearing outer diameter D	Dimension series			Chamfer dimension r (min.)
			70	90	10			71	91	11	
			Nominal height T					Nominal height T			
68	340	380	18	24	30	1	420	36	48	64	2
72	360	400	18	24	30	1	440	36	48	65	2
76	380	420	18	24	30	1	460	36	48	65	2
80	400	440	18	24	30	1	480	36	48	65	2
84	420	460	18	24	30	1	500	36	48	65	2
88	440	480	18	24	30	1	540	45	60	80	2.1
92	460	500	18	24	30	1	560	45	60	80	2.1
96	480	520	18	24	30	1	580	45	60	80	2.1
/500	500	540	18	24	30	1	600	45	60	80	2.1
/530	530	580	23	30	38	1.1	640	50	67	85	3
/560	560	610	23	30	38	1.1	670	50	67	85	3
/600	600	650	23	30	38	1.1	710	50	67	85	3
/630	630	680	23	30	38	1.1	750	54	73	95	3
/670	670	730	27	36	45	1.5	800	58	78	105	4
/710	710	780	32	42	53	1.5	850	63	85	112	4
/750	750	820	32	42	53	1.5	900	67	90	120	4
/800	800	870	32	42	53	1.5	950	67	90	120	4
/850	850	920	32	42	53	1.5	1000	67	90	120	4
/900	900	980	36	48	63	2	1060	73	95	130	5
/950	950	1030	36	48	63	2	1120	78	103	135	5
/1000	1000	1090	41	54	70	2.1	1180	82	109	140	5
/1060	1060	1150	41	54	70	2.1	1250	85	115	150	5
/1120	1120	1220	45	60	80	2.1	1320	90	122	160	5
/1180	1180	1280	45	60	80	2.1	1400	100	132	175	6
/1250	1250	1360	50	67	85	3	1460	—	—	175	6
/1320	1320	1440	—	—	95	3	1540	—	—	175	6
/1400	1400	1520	—	—	95	3	1630	—	—	180	6
/1500	1500	1630	—	—	105	4	1750	—	—	195	6
/1600	1600	1730	—	—	105	4	1850	—	—	195	6
/1700	1700	1840	—	—	112	4	1970	—	—	212	7.5
/1800	1800	1950	—	—	120	4	2080	—	—	220	7.5
/1900	1900	2060	—	—	130	5	2180	—	—	220	7.5
/2000	2000	2160	—	—	130	5	2300	—	—	236	7.5
/2120	2120	2300	—	—	140	5	2430	—	—	243	7.5
/2240	2240	2430	—	—	150	5	2670	—	—	258	9.5
/2360	2360	2550	—	—	150	5	2700	—	—	265	9.5
/2500	2500	2700	—	—	160	5	2850	—	—	272	9.5

Note: 1. Dimension series 22, 23, and 24 are double row bearing series.
 2. For the outer diameter of the shaft raceway washer and the inner diameter of the housing raceway washer, see the dimension table of thrust bearings.

Appendix table-3: Boundary dimensions of single direction thrust bearings-4

Unit: mm

Thrust ball bearings		512										522			
Spherical roller thrust bearings		292													
Bore diameter code	Nominal bearing bore diameter d	Nominal bearing outer diameter D	Diameter series 2										Chamfer dimension r (min.)	Chamfer dimension r_1 (min.)	
			Dimension series								Central raceway washer				
			72	92	12	22	22		Nominal bore diameter d_2	Nominal height B					
			Nominal height T												
68	340	460	54	73	96	—	—	—	—	—	—	3	—		
72	360	500	63	85	110	—	—	—	—	—	—	4	—		
76	380	520	63	85	112	—	—	—	—	—	—	4	—		
80	400	540	63	85	112	—	—	—	—	—	—	4	—		
84	420	580	73	95	130	—	—	—	—	—	—	5	—		
88	440	600	73	95	130	—	—	—	—	—	—	5	—		
92	460	620	73	95	130	—	—	—	—	—	—	5	—		
96	480	650	78	103	135	—	—	—	—	—	—	5	—		
/500	500	670	78	103	135	—	—	—	—	—	—	5	—		
/530	530	710	82	109	140	—	—	—	—	—	—	5	—		
/560	560	750	85	115	150	—	—	—	—	—	—	5	—		
/600	600	800	90	122	160	—	—	—	—	—	—	5	—		
/630	630	850	100	132	175	—	—	—	—	—	—	6	—		
/670	670	900	103	140	180	—	—	—	—	—	—	6	—		
/710	710	950	109	145	190	—	—	—	—	—	—	6	—		
/750	750	1000	112	150	195	—	—	—	—	—	—	6	—		
/800	800	1060	118	155	205	—	—	—	—	—	—	7.5	—		
/850	850	1120	122	160	212	—	—	—	—	—	—	7.5	—		
/900	900	1180	125	170	220	—	—	—	—	—	—	7.5	—		
/950	950	1250	136	180	236	—	—	—	—	—	—	7.5	—		
/1000	1000	1320	145	190	250	—	—	—	—	—	—	9.5	—		
/1060	1060	1400	155	206	265	—	—	—	—	—	—	9.5	—		
/1120	1120	1460	—	206	—	—	—	—	—	—	—	9.5	—		
/1180	1180	1520	—	206	—	—	—	—	—	—	—	9.5	—		
/1250	1250	1610	—	216	—	—	—	—	—	—	—	9.5	—		
/1320	1320	1700	—	228	—	—	—	—	—	—	—	9.5	—		
/1400	1400	1790	—	234	—	—	—	—	—	—	—	12	—		
/1500	1500	1920	—	252	—	—	—	—	—	—	—	12	—		
/1600	1600	2040	—	264	—	—	—	—	—	—	—	15	—		
/1700	1700	2160	—	276	—	—	—	—	—	—	—	15	—		
/1800	1800	2280	—	288	—	—	—	—	—	—	—	15	—		
/1900	1900	—	—	—	—	—	—	—	—	—	—	—	—		
/2000	2000	—	—	—	—	—	—	—	—	—	—	—	—		
/2120	2120	—	—	—	—	—	—	—	—	—	—	—	—		
/2240	2240	—	—	—	—	—	—	—	—	—	—	—	—		
/2360	2360	—	—	—	—	—	—	—	—	—	—	—	—		
/2500	2500	—	—	—	—	—	—	—	—	—	—	—	—		

Appendix table-3: Boundary dimensions of single direction thrust bearings-5 Unit: mm

Thrust ball bearings						513		523						
Spherical roller thrust bearings				293										
Bore diameter code	Nominal bearing bore diameter d	Nominal bearing outer diameter D	Diameter series 3									Chamfer dimension r (min.)	Chamfer dimension r_1 (min.)	
			Dimension series						Central raceway washer		Chamfer dimension r (min.)			Chamfer dimension r_1 (min.)
			73	93	13	23	23		Nominal bore diameter d_2	Nominal height B				
			Nominal height T											
68	340	540	90	122	160	—	—	—	5	—	—			
72	360	560	90	122	160	—	—	—	5	—	—			
76	380	600	100	132	175	—	—	—	6	—	—			
80	400	620	100	132	175	—	—	—	6	—	—			
84	420	650	103	140	180	—	—	—	6	—	—			
88	440	680	109	145	190	—	—	—	6	—	—			
92	460	710	112	150	195	—	—	—	6	—	—			
96	480	730	112	150	195	—	—	—	6	—	—			
/500	500	750	112	150	195	—	—	—	6	—	—			
/530	530	800	122	160	212	—	—	—	7.5	—	—			
/560	560	850	132	175	224	—	—	—	7.5	—	—			
/600	600	900	136	180	236	—	—	—	7.5	—	—			
/630	630	950	145	190	250	—	—	—	9.5	—	—			
/670	670	1000	150	200	258	—	—	—	9.5	—	—			
/710	710	1060	160	212	272	—	—	—	9.5	—	—			
/750	750	1120	165	224	290	—	—	—	9.5	—	—			
/800	800	1180	170	230	300	—	—	—	9.5	—	—			
/850	850	1250	180	243	315	—	—	—	12	—	—			
/900	900	1320	190	250	335	—	—	—	12	—	—			
/950	950	1400	200	272	355	—	—	—	12	—	—			
/1000	1000	1460	—	276	—	—	—	—	12	—	—			
/1060	1060	1540	—	288	—	—	—	—	15	—	—			
/1120	1120	1630	—	306	—	—	—	—	15	—	—			
/1180	1180	1710	—	318	—	—	—	—	15	—	—			
/1250	1250	1800	—	330	—	—	—	—	19	—	—			
/1320	1320	1900	—	348	—	—	—	—	19	—	—			
/1400	1400	2000	—	360	—	—	—	—	19	—	—			
/1500	1500	2140	—	384	—	—	—	—	19	—	—			
/1600	1600	2270	—	402	—	—	—	—	19	—	—			
/1700	1700	—	—	—	—	—	—	—	—	—	—			
/1800	1800	—	—	—	—	—	—	—	—	—	—			
/1900	1900	—	—	—	—	—	—	—	—	—	—			
/2000	2000	—	—	—	—	—	—	—	—	—	—			
/2120	2120	—	—	—	—	—	—	—	—	—	—			
/2240	2240	—	—	—	—	—	—	—	—	—	—			
/2360	2360	—	—	—	—	—	—	—	—	—	—			
/2500	2500	—	—	—	—	—	—	—	—	—	—			

Note: 1. Dimension series 22, 23, and 24 are double row bearing series.
 2. For the outer diameter of the shaft raceway washer and the inner diameter of the housing raceway washer, see the dimension table of thrust bearings.

Appendix table-3: Boundary dimensions of single direction thrust bearings-6 Unit: mm

Thrust ball bearings						514		524							
Spherical roller thrust bearings				294											
Bore diameter code	Nominal bearing bore diameter d	Nominal bearing outer diameter D	Diameter series 4									Diameter series 5			
			Dimension series						Central raceway washer		Chamfer dimension r (min.)	Chamfer dimension r_1 (min.)	Nominal bearing outer diameter D	Dimension series 95	Chamfer dimension r (min.)
			74	94	14	24	24		Nominal bore diameter d_2	Nominal height B					
			Nominal height T												
68	340	620	125	170	220	—	—	—	7.5	—	750	243	12		
72	360	640	125	170	220	—	—	—	7.5	—	780	250	12		
76	380	670	132	175	224	—	—	—	7.5	—	820	265	12		
80	400	710	140	185	243	—	—	—	7.5	—	850	272	12		
84	420	730	140	185	243	—	—	—	7.5	—	900	290	15		
88	440	780	155	206	265	—	—	—	9.5	—	950	308	15		
92	460	800	155	206	265	—	—	—	9.5	—	980	315	15		
96	480	850	165	224	290	—	—	—	9.5	—	1000	315	15		
/500	500	870	165	224	290	—	—	—	9.5	—	1060	335	15		
/530	530	920	175	236	308	—	—	—	9.5	—	1090	335	15		
/560	560	980	190	250	335	—	—	—	12	—	1150	355	15		
/600	600	1030	195	258	335	—	—	—	12	—	1220	375	15		
/630	630	1090	206	280	365	—	—	—	12	—	1280	388	15		
/670	670	1150	218	290	375	—	—	—	15	—	1320	388	15		
/710	710	1220	230	308	400	—	—	—	15	—	1400	412	15		
/750	750	1280	236	315	412	—	—	—	15	—	—	—	—		
/800	800	1360	250	335	438	—	—	—	15	—	—	—	—		
/850	850	1440	—	354	—	—	—	—	15	—	—	—	—		
/900	900	1520	—	372	—	—	—	—	15	—	—	—	—		
/950	950	1600	—	390	—	—	—	—	15	—	—	—	—		
/1000	1000	1670	—	402	—	—	—	—	15	—	—	—	—		
/1060	1060	1770	—	426	—	—	—	—	15	—	—	—	—		
/1120	1120	1860	—	444	—	—	—	—	15	—	—	—	—		
/1180	1180	1950	—	462	—	—	—	—	19	—	—	—	—		
/1250	1250	2050	—	480	—	—	—	—	19	—	—	—	—		
/1320	1320	2160	—	505	—	—	—	—	19	—	—	—	—		
/1400	1400	2280	—	530	—	—	—	—	19	—	—	—	—		
/1500	1500	—	—	—	—	—	—	—	—	—	—	—	—		
/1600	1600	—	—	—	—	—	—	—	—	—	—	—	—		
/1700	1700	—	—	—	—	—	—	—	—	—	—	—	—		
/1800	1800	—	—	—	—	—	—	—	—	—	—	—	—		
/1900	1900	—	—	—	—	—	—	—	—	—	—	—	—		
/2000	2000	—	—	—	—	—	—	—	—	—	—	—	—		
/2120	2120	—	—	—	—	—	—	—	—	—	—	—	—		
/2240	2240	—	—	—	—	—	—	—	—	—	—	—	—		
/2360	2360	—	—	—	—	—	—	—	—	—	—	—	—		
/2500	2500	—	—	—	—	—	—	—	—	—	—	—	—		

Appendix table-4: Comparison table of SI and CGS series gravity units-1

Unit system	Quantity	Length L	Mass M	Time T	Acceleration	Force	Stress	Pressure	Energy
SI		m	kg	s	m/s ²	N	Pa	Pa	J
CGS system		cm	g	s	Gal	dyn	dyn/cm ²	dyn/cm ²	erg
Gravitation system		m	kgf · s ² /m	s	m/s ²	kgf	kgf/m ²	kgf/m ²	kgf · m

Appendix table-5: SI-customary unit conversion table-1

Quantity	Unit designation	Code	Conversion rate to SI	SI unit designation	Code
Angle	Degree	°	$\pi/180$	Radian	rad
	Minute	'	$\pi/10\ 800$		
	Second	" (sec)	$\pi/648\ 000$		
Length	Meter	m	1	Meter	m
	Micron	μ	10^{-6}		
	Angstrom	Å	10^{-10}		
Area	Square meter	m ²	1	Square meter	m ²
	Are	a	10^2		
	Hectare	ha	10^4		
Volume	Cubic meter	m ³	1	Cubic meter	m ³
	Liter	ℓ.L	10^{-3}		
Mass	Kilogram	kg	1	Kilogram	kg
	Ton	t	10^3		
	Kilogram force / square second per meter	kgf · s ² /m	9.806 65		
Time	Second	s	1	Second	s
	Minute	min	60		
	Hour	h	3 600		
	Day	d	86 400		
Speed	Meters per second	m/s	1	Meters per second	m/s
	Knot	kn	1 852/3 600		
Frequency and vibration	Cycle	s ⁻¹ (pps)	1	Hertz	Hz
Revolutions (rotational speed)	Revolutions per minute (rpm)	rpm(r/min)	1/60	Per second	s ⁻¹
Angular velocity	Radians per second	rad/s	1	Radians per second	rad/s
Acceleration	Meters per square second	m/s ²	1	Radians per second	m/s ²
	G	G	9.806 65		
Force	Kilogram force	kgf	9.806 65	Newton	N
	Ton force	tf	9 806.65		
	Dyne	dyn	10^{-5}		
Force moment	Kilogram force / meter	kgf · m	9.806 65	Newton meter	N · m
Inertia moment	Kilogram force / meter / square second	kgf · m · s ⁻²	9.806 65	Kilogram / square meter	kg · m ²
	Stress	Kilogram force per square meter	kgf/m ²	Pascal or newton per square meter	Pa or N/m ²
Pressure	Kilogram force per square meter	kgf/m ²	9.806 65	Pascal	Pa
	Meter water column	mH ₂ O	9 806.65		
	Meter of mercury	mHg	101 325/0.76		
	Torr	Torr	101 325/760		
	Atmosphere	atm	101 325		
Bar	bar	10^5			
Energy	Erg	erg	10^{-7}	Joule	J
	IT calorie	cal _{IT}	4.186 8		
	Kilogram force / meter	kgf · m	9.806 65		
	Kilowatt hour	kW · h	3.600×10^6		
Metric horsepower per hour	PS · h	$2.647\ 79 \times 10^6$			
Power rate and power	Watt	W	1	Watt	W
	Metric horsepower	PS	735.5		
	Kilogram force / meter per second	kgf · m/s	9.806 65		

Appendix table-4: Comparison table of SI and CGS series gravity units-2

Unit system	Quantity	Power rate	Temperature	Viscosity	Dynamic viscosity	Flux	Flux density	Magnetic field strength
SI		W	K	Pa · s	m ² /s	Wb	T	A/m
CGS system		erg/s	°C	P	St	Mx	Gs	Oe
Gravitation system		kgf · m/s	°C	kgf · s/m ²	m ² /s	—	—	—

Appendix table-5: SI-customary unit conversion table-2

Quantity	Unit designation	Code	Conversion rate to SI	SI unit designation	Code
Viscosity	Poise	P	10^{-1}	Pascal second	Pa · s
	Centipoise	cP	10^{-3}		
	Kilogram force / square second per meter	kgf · s/m ²	9.806 65		
Dynamic viscosity	Stoke	St	10^{-4}	Square meter per second	m ² /s
	Centistoke	cSt	10^{-6}		
Temperature	Degree	°C	+273.15	Kelvin	K
Radioactivity	Curie	Ci	3.7×10^{10}	Becquerel	Bq
	Dosage	Roentgen	2.58×10^{-4}		
Absorption dosage	Dosage equivalent	rad	10^{-2}	Gray	Gy
	Dosage equivalent	rem	10^{-2}		
Dosage equivalent	Maxwell	Mx	10^{-8}	Weber	Wb
Flux density	Gamma	γ	10^{-9}	Tesla	T
Gauss	Gs	10^{-4}			
Magnetic field strength	Oersted	Oe	$10^3/4\pi$	Amperes per meter	A/m
Magnetic field strength	Coulomb	C	1	Coulomb	C
Potential difference	Volt	V	1	Volt	V
Electric resistance	Ohm	Ω	1	Ohm	Ω
	Current	Ampere	A		

Appendix table-6: Tenth power multiples of SI unit

Multiples of unit	Prefix		Multiples of unit	Prefix	
	Designation	Code		Designation	Code
10 ¹⁸	Exa	E	10 ⁻¹	Deci	d
10 ¹⁵	Peta	P	10 ⁻²	Centi	c
10 ¹²	Tera	T	10 ⁻³	Milli	m
10 ⁹	Giga	G	10 ⁻⁵	Micro	μ
10 ⁶	Mega	M	10 ⁻⁹	Nano	n
10 ³	Kilo	k	10 ⁻¹²	Pico	p
10 ²	Hecto	h	10 ⁻¹⁵	Femto	f
10	Deca	da	10 ⁻¹⁸	Atto	a

Appendix table-7: Dimensional tolerance for shafts

Diameter division mm		a13		c12		d6		e6		e13		f5		f6		g5		g6	
Over	Incl.	Upper	Lower	Upper	Lower	Upper	Lower	Upper	Lower	Upper	Lower	Upper	Lower	Upper	Lower	Upper	Lower	Upper	Lower
-	3	-270	-410	-60	-160	-20	-26	-14	-20	-14	-154	-6	-10	-6	-12	-2	-6	-2	-8
3	6	-270	-450	-70	-190	-30	-38	-20	-28	-20	-200	-10	-15	-10	-18	-4	-9	-4	-12
6	10	-280	-500	-80	-230	-40	-49	-25	-34	-25	-245	-13	-19	-13	-22	-5	-11	-5	-14
10	18	-290	-560	-95	-275	-50	-61	-32	-43	-32	-302	-16	-24	-16	-27	-6	-14	-6	-17
18	30	-300	-630	-110	-320	-65	-78	-40	-53	-40	-370	-20	-29	-20	-33	-7	-16	-7	-20
30	40	-310	-700	-120	-370	-80	-96	-50	-66	-50	-440	-25	-36	-25	-41	-9	-20	-9	-25
40	50	-320	-710	-130	-380	-90	-108	-60	-79	-60	-520	-30	-43	-30	-49	-10	-23	-10	-29
50	65	-340	-800	-140	-440	-100	-119	-70	-91	-70	-610	-36	-51	-36	-58	-12	-27	-12	-34
65	80	-360	-820	-150	-450	-110	-131	-80	-103	-80	-700	-42	-59	-42	-66	-14	-31	-14	-38
80	100	-380	-920	-160	-520	-120	-142	-90	-115	-90	-800	-48	-67	-48	-74	-16	-35	-16	-44
100	120	-410	-950	-180	-530	-140	-154	-100	-127	-100	-900	-54	-75	-54	-82	-18	-39	-18	-48
120	140	-460	-1090	-200	-600	-145	-170	-110	-142	-110	-1000	-60	-83	-60	-90	-20	-43	-20	-52
140	160	-520	-1150	-210	-610	-155	-180	-120	-152	-120	-1100	-66	-91	-66	-98	-22	-47	-22	-56
160	180	-580	-1210	-230	-630	-170	-199	-130	-164	-130	-1200	-72	-99	-72	-106	-24	-51	-24	-60
180	200	-660	-1380	-240	-700	-180	-210	-140	-176	-140	-1300	-78	-107	-78	-114	-26	-55	-26	-64
200	225	-740	-1460	-260	-720	-190	-229	-150	-188	-150	-1400	-84	-115	-84	-122	-28	-59	-28	-68
225	250	-820	-1540	-280	-740	-200	-241	-160	-200	-160	-1500	-90	-123	-90	-130	-30	-63	-30	-72
250	280	-920	-1730	-300	-820	-210	-252	-170	-211	-170	-1600	-96	-131	-96	-138	-32	-67	-32	-76
280	315	-1050	-1860	-330	-850	-220	-264	-180	-222	-180	-1700	-102	-139	-102	-146	-34	-71	-34	-80
315	355	-1200	-2090	-360	-930	-230	-276	-190	-234	-190	-1800	-108	-147	-108	-154	-36	-75	-36	-84
355	400	-1350	-2240	-400	-970	-240	-288	-200	-246	-200	-1900	-114	-155	-114	-162	-38	-79	-38	-88
400	450	-1500	-2470	-440	-1070	-250	-300	-210	-258	-210	-2000	-120	-163	-120	-170	-40	-83	-40	-92
450	500	-1650	-2620	-480	-1110	-260	-312	-220	-270	-220	-2100	-126	-171	-126	-178	-42	-87	-42	-96
500	560	-	-	-	-	-260	-304	-230	-282	-230	-2200	-132	-179	-132	-186	-44	-91	-44	-100
560	630	-	-	-	-	-270	-316	-240	-294	-240	-2300	-138	-187	-240	-198	-46	-95	-46	-104
630	710	-	-	-	-	-290	-340	-260	-318	-260	-2400	-144	-195	-260	-210	-48	-99	-48	-108
710	800	-	-	-	-	-300	-352	-270	-330	-270	-2500	-150	-203	-270	-222	-50	-103	-50	-112
800	900	-	-	-	-	-320	-376	-290	-354	-290	-2600	-156	-211	-290	-234	-52	-107	-52	-116
900	1000	-	-	-	-	-330	-388	-300	-366	-300	-2700	-162	-219	-300	-246	-54	-111	-54	-120
1000	1120	-	-	-	-	-350	-416	-320	-390	-320	-2800	-168	-227	-320	-258	-56	-115	-56	-124
1120	1250	-	-	-	-	-360	-428	-330	-402	-330	-2900	-174	-235	-330	-270	-58	-119	-58	-128
1250	1400	-	-	-	-	-390	-468	-360	-442	-360	-3000	-180	-243	-360	-282	-60	-123	-60	-132
1400	1600	-	-	-	-	-420	-508	-390	-482	-390	-3100	-186	-251	-390	-294	-62	-127	-62	-136
1600	1800	-	-	-	-	-440	-532	-410	-506	-410	-3200	-192	-259	-410	-306	-64	-131	-64	-140
1800	2000	-	-	-	-	-460	-556	-430	-530	-430	-3300	-198	-267	-430	-318	-66	-135	-66	-144
2000	2240	-	-	-	-	-480	-580	-450	-554	-450	-3400	-204	-275	-450	-330	-68	-139	-68	-148
2240	2500	-	-	-	-	-500	-604	-470	-578	-470	-3500	-210	-283	-470	-342	-70	-143	-70	-152
2500	2800	-	-	-	-	-520	-628	-490	-602	-490	-3600	-216	-291	-490	-354	-72	-147	-72	-156
2800	3150	-	-	-	-	-540	-652	-510	-626	-510	-3700	-222	-299	-510	-366	-74	-151	-74	-160

1) Basic tolerance a is not used for the basic size tolerance with respect to the size of 1 mm or below shown in drawings.

Diameter division mm		j5		js5		j6		js6		j7		k4		k5		k6		m5	
Over	Incl.	Upper	Lower	Upper	Lower	Upper	Lower	Upper	Lower	Upper	Lower	Upper	Lower	Upper	Lower	Upper	Lower	Upper	Lower
-	3	+2	-2	+2	-2	+4	-2	+3	-3	+6	-4	+3	0	+4	0	+6	0	+6	+2
3	6	+3	-2	+2.5	-2.5	+6	-2	+4	-4	+8	-4	+5	+1	+6	+1	+9	+1	+9	+4
6	10	+4	-2	+3	-3	+7	-2	+4.5	-4.5	+10	-5	+5	+1	+7	+1	+10	+1	+12	+6
10	18	+5	-3	+4	-4	+8	-3	+5.5	-5.5	+12	-6	+6	+1	+9	+1	+12	+1	+15	+7
18	30	+5	-4	+4.5	-4.5	+9	-4	+6.5	-6.5	+13	-8	+8	+2	+11	+2	+15	+2	+17	+8
30	40	+6	-5	+5.5	-5.5	+11	-5	+8	-8	+15	-10	+9	+2	+13	+2	+18	+2	+20	+9
40	50	+6	-7	+6.5	-6.5	+12	-7	+9.5	-9.5	+18	-12	+10	+2	+15	+2	+21	+2	+24	+11
50	65	+6	-9	+7.5	-7.5	+13	-9	+11	-11	+20	-15	+13	+3	+18	+3	+25	+3	+28	+13
65	80	+7	-11	+9	-9	+14	-11	+12.5	-12.5	+22	-18	+15	+3	+21	+3	+28	+3	+33	+15
80	100	+7	-13	+10	-10	+16	-13	+14.5	-14.5	+25	-21	+18	+4	+24	+4	+33	+4	+37	+17
100	120	+7	-16	+11.5	-11.5	+16	-16	+16	-16	+26	-26	+20	+4	+27	+4	+36	+4	+43	+20
120	140	+7	-18	+12.5	-12.5	+18	-18	+18	-18	+29	-28	+22	+4	+29	+4	+40	+4	+46	+21
140	160	+7	-20	+13.5	-13.5	+20	-20	+20	-20	+31	-32	+25	+5	+32	+5	+45	+5	+50	+23
160	180	-	-	+16	-16	-	-	+22	-22	-	-	-	-	-	-	+44	0	-	-
180	200	-	-	+18	-18	-	-	+25	-25	-	-	-	-	-	-	+50	0	-	-
200	225	-	-	+20	-20	-	-	+28	-28	-	-	-	-	-	-	+56	0	-	-
225	250	-	-	+23.5	-23.5	-	-	+33	-33	-	-	-	-	-	-	+66	0	-	-
250	280	-	-	+27.5	-27.5	-	-	+39	-39	-	-	-	-	-	-	+78	0	-	-
280	315	-	-	+32.5	-32.5	-	-	+46	-46	-	-	-	-	-	-	+92	0	-	-
315	355	-	-	+39	-39	-	-	+55	-55	-	-	-	-	-	-	+110	0	-	-
355	400	-	-	+48	-48	-	-	+67.5	-67.5	-	-	-	-	-	-	+135	0	-	-

Unit: μm

h4		h5		h6		h7		h8		h9		h10		h11		h13		js4		Diameter division mm	
Upper	Lower	Upper	Lower	Upper	Lower	Upper	Lower	Upper	Lower	Upper	Lower	Upper	Lower	Upper	Lower	Upper	Lower	Upper	Lower	Over	Incl.
0	-3	0	-4	0	-6	0	-10	0	-14	0	-25	0	-40	0	-60	0	-140	+1.5	-1.5	-	3
0	-4	0	-5	0	-8	0	-12	0	-18	0	-30	0	-48	0	-75	0	-180	+2	-2	3	6
0	-4	0	-6	0	-9	0	-15	0	-22	0	-36	0	-58	0	-90	0	-220	+2	-2	6	10
0	-5	0	-8	0	-11	0	-18	0	-27	0	-43	0	-70	0	-110	0	-270	+2.5	-2.5	10	18
0	-6	0	-9	0	-13	0	-21	0	-33	0	-52	0	-84	0	-130	0	-330	+3	-3	18	30
0	-7	0	-11	0	-16	0	-25	0	-39	0	-62	0	-100	0	-160	0	-390	+3.5	-3.5	30	40
0	-8	0	-13	0	-19	0	-30	0	-46	0	-74	0	-120	0	-190	0	-460	+4	-4	40	50
0	-10	0	-15	0	-22	0	-35	0	-54	0	-87	0	-140	0	-220	0	-540	+5	-5	50	65
0	-12	0	-18	0	-25	0	-40	0	-63	0	-100	0	-160	0	-250	0	-630	+6	-6	65	80
0	-14	0	-20	0	-29	0	-46	0	-72	0	-115	0	-185	0	-290	0	-720	+7	-7	80	100
0	-16	0	-23	0	-32	0	-52	0	-81	0	-130	0	-210	0	-320	0	-810	+8	-8	100	120
0	-18	0	-25	0	-36	0	-57	0	-89	0	-140	0	-230	0	-360	0	-890	+9	-9	120	140
0	-20	0	-27	0	-40	0	-63	0	-97	0	-155	0	-250	0	-400	0	-970	+10	-10	140	160
0	-22	0	-32	0	-44	0	-70	0	-110	0	-175	0	-280	0	-440	0	-1100	+11	-11	160	180
0	-25	0	-36	0	-50	0	-80	0	-125	0	-200	0	-320								

Appendix table-8: Dimensional tolerance for housing bore

Diameter division mm		E7		E10		E11		E12		F6		F7		F8		G6	
Over	Incl.	Upper	Lower	Upper	Lower	Upper	Lower	Upper	Lower	Upper	Lower	Upper	Lower	Upper	Lower	Upper	Lower
-	3	+24	+14	+54	+14	+74	+14	+114	+14	+12	+6	+16	+6	+20	+6	+8	+2
3	6	+32	+20	+68	+20	+95	+20	+140	+20	+18	+10	+22	+10	+28	+10	+12	+4
6	10	+40	+25	+83	+25	+115	+25	+175	+25	+22	+13	+28	+13	+35	+13	+14	+5
10	18	+50	+32	+102	+32	+142	+32	+212	+32	+27	+16	+34	+16	+43	+16	+17	+6
18	30	+61	+40	+124	+40	+170	+40	+250	+40	+33	+20	+41	+20	+53	+20	+20	+7
30	40	+75	+50	+150	+50	+210	+50	+300	+50	+41	+25	+50	+25	+64	+25	+25	+9
40	50	+90	+60	+180	+60	+250	+60	+360	+60	+49	+30	+60	+30	+76	+30	+29	+10
50	65	+107	+72	+212	+72	+292	+72	+422	+72	+58	+36	+71	+36	+90	+36	+34	+12
65	80	+125	+85	+245	+85	+335	+85	+485	+85	+68	+43	+83	+43	+106	+43	+39	+14
80	100	+146	+100	+285	+100	+390	+100	+560	+100	+79	+50	+96	+50	+122	+50	+44	+15
100	120	+162	+110	+320	+110	+430	+110	+630	+110	+88	+56	+108	+56	+137	+56	+49	+17
120	140	+182	+125	+355	+125	+485	+125	+695	+125	+98	+62	+119	+62	+151	+62	+54	+18
140	160	+198	+135	+385	+135	+535	+135	+765	+135	+108	+68	+131	+68	+165	+68	+60	+20
160	180	+215	+145	+425	+145	+585	+145	+845	+145	+120	+76	+146	+76	+186	+76	+66	+22
180	200	+240	+160	+480	+160	+660	+160	+960	+160	+130	+80	+160	+80	+205	+80	+74	+24
200	225	+260	+170	+530	+170	+730	+170	+1070	+170	+142	+86	+176	+86	+226	+86	+82	+26
225	250	+300	+195	+615	+195	+855	+195	+1245	+195	+164	+98	+203	+98	+263	+98	+94	+28
250	280	+345	+220	+720	+220	+1000	+220	+1470	+220	+188	+110	+235	+110	+305	+110	+108	+30
280	315	+390	+240	+840	+240	+1160	+240	+1740	+240	+212	+120	+270	+120	+350	+120	+124	+32
315	355	+435	+260	+960	+260	+1360	+260	+2010	+260	+240	+130	+305	+130	+410	+130	+144	+34
355	400	+500	+290	+1150	+290	+1640	+290	+2390	+290	+280	+145	+355	+145	+475	+145	+173	+38

Diameter division mm		J6		Js6		J7		Js7		K5		K6		K7		M6	
Over	Incl.	Upper	Lower	Upper	Lower	Upper	Lower	Upper	Lower	Upper	Lower	Upper	Lower	Upper	Lower	Upper	Lower
-	3	+2	-4	+3	-3	+4	-6	+5	-5	0	-4	0	-6	0	-10	-2	-8
3	6	+5	-3	+4	-4	+6	-6	+6	-6	0	-5	+2	-6	+3	-9	-1	-9
6	10	+5	-4	+4.5	-4.5	+8	-7	+7.5	-7.5	+1	-5	+2	-7	+5	-10	-3	-12
10	18	+6	-5	+5.5	-5.5	+10	-8	+9	-9	+2	-6	+2	-9	+6	-12	-4	-15
18	30	+8	-5	+6.5	-6.5	+12	-9	+10.5	-10.5	+1	-8	+2	-11	+6	-15	-4	-17
30	40	+10	-6	+8	-8	+14	-11	+12.5	-12.5	+2	-9	+3	-13	+7	-18	-4	-20
40	50	+13	-6	+9.5	-9.5	+18	-12	+15	-15	+3	-10	+4	-15	+9	-21	-5	-24
50	65	+16	-6	+11	-11	+22	-13	+17.5	-17.5	+2	-13	+4	-18	+10	-25	-6	-28
65	80	+18	-7	+12.5	-12.5	+26	-14	+20	-20	+3	-15	+4	-21	+12	-28	-8	-33
80	100	+22	-7	+14.5	-14.5	+30	-16	+23	-23	+2	-18	+5	-24	+13	-33	-8	-37
100	120	+25	-7	+16	-16	+36	-16	+26	-26	+3	-20	+5	-27	+16	-36	-9	-41
120	140	+29	-7	+18	-18	+39	-18	+28.5	-28.5	+3	-22	+7	-29	+17	-40	-10	-46
140	160	+33	-7	+20	-20	+43	-20	+31.5	-31.5	+2	-25	+8	-32	+18	-45	-10	-50
160	180	-	-	+22	-22	-	-	+35	-35	-	-	0	-44	0	-70	-26	-70
180	200	-	-	+25	-25	-	-	+40	-40	-	-	0	-50	0	-80	-30	-80
200	225	-	-	+28	-28	-	-	+45	-45	-	-	0	-56	0	-90	-34	-90
225	250	-	-	+33	-33	-	-	+52.5	-52.5	-	-	0	-66	0	-105	-40	-106
250	280	-	-	+39	-39	-	-	+62.5	-62.5	-	-	0	-78	0	-125	-48	-126
280	315	-	-	+46	-46	-	-	+75	-75	-	-	0	-92	0	-150	-58	-150
315	355	-	-	+55	-55	-	-	+87.5	-87.5	-	-	0	-110	0	-175	-68	-178
355	400	-	-	+67.5	-67.5	-	-	+105	-105	-	-	0	-135	0	-210	-76	-211

Unit: μm

Diameter division mm		G7		H6		H7		H8		H9		H10		H11		H13		Diameter division mm	
Over	Incl.	Upper	Lower	Upper	Lower	Upper	Lower	Upper	Lower	Upper	Lower	Upper	Lower	Upper	Lower	Upper	Lower	Over	Incl.
-	3	+12	+2	+6	0	+10	0	+14	0	+25	0	+40	0	+60	0	+140	0	-	3
3	6	+16	+4	+8	0	+12	0	+18	0	+30	0	+48	0	+75	0	+180	0	3	6
6	10	+20	+5	+9	0	+15	0	+22	0	+36	0	+58	0	+90	0	+220	0	6	10
10	18	+24	+6	+11	0	+18	0	+27	0	+43	0	+70	0	+110	0	+270	0	10	18
18	30	+28	+7	+13	0	+21	0	+33	0	+52	0	+84	0	+130	0	+330	0	18	30
30	40	+34	+9	+16	0	+25	0	+39	0	+62	0	+100	0	+160	0	+390	0	30	40
40	50	+40	+10	+19	0	+30	0	+46	0	+74	0	+120	0	+190	0	+460	0	40	50
50	65	+47	+12	+22	0	+35	0	+54	0	+87	0	+140	0	+220	0	+540	0	50	65
65	80	+54	+14	+25	0	+40	0	+63	0	+100	0	+160	0	+250	0	+630	0	65	80
80	100	+61	+15	+29	0	+46	0	+72	0	+115	0	+185	0	+290	0	+720	0	80	100
100	120	+69	+17	+32	0	+52	0	+81	0	+130	0	+210	0	+320	0	+810	0	100	120
120	140	+75	+18	+36	0	+57	0	+89	0	+140	0	+230	0	+360	0	+890	0	120	140
140	160	+83	+20	+40	0	+63	0	+97	0	+155	0	+250	0	+400	0	+970	0	140	160
160	180	+92	+22	+44	0	+70	0	+110	0	+175	0	+280	0	+440	0	+1100	0	160	180
180	200	+104	+24	+50	0	+80	0	+125	0	+200	0	+320	0	+500	0	+1250	0	180	200
200	225	+116	+26	+56	0	+90	0	+140	0	+230	0	+360	0	+560	0	+1400	0	200	225
225	250	+133	+28	+66	0	+105	0	+165	0	+260	0	+420	0	+660	0	+1650	0	225	250
250	280	+155	+30	+78	0	+125	0	+195	0	+310	0	+500	0	+780	0	+1950	0	250	280
280	315	+182	+32	+92	0	+150	0	+230	0	+370	0	+600	0	+920	0	+2300	0	280	315
315	355	+209	+34	+110	0	+175	0	+280	0	+440	0	+700	0	+1100	0	+2800	0	315	355
355	400	+248	+38	+135	0	+210	0	+330	0	+540	0	+860	0	+1350	0	+3300	0	355	400

Unit: μm

Diameter division mm		M7		N6		N7		P6		P7		R6		R7		Diameter division mm	
Over	Incl.	Upper	Lower	Upper	Lower	Upper	Lower	Upper	Lower	Upper	Lower	Upper	Lower	Upper	Lower	Over	Incl.
-	3	-2	-12	-4	-10	-4	-14	-6	-12	-6	-16	-10	-16	-10	-20	-	3
3	6	0	-18	-5	-13	-4	-16	-9	-17	-8	-20	-12	-20	-11	-23	3	6
6	10	0	-15	-7	-16	-4	-19	-12	-21	-9	-24	-16	-25	-13	-28	6	10
10	18	0	-18	-9	-20	-5	-23	-15	-26	-11	-29	-20	-31	-16	-34	10	18
18	30	0	-21	-11	-24	-7	-28	-18	-31	-14	-35	-24	-37	-20	-41	18	30
30	40	0	-25	-12	-28	-8	-33	-21	-37	-17	-42	-29	-45	-25	-50	30	40
40	50	0	-30	-14	-33	-9	-39	-26	-45	-21	-51	-35	-54	-30	-60	40	50
50	65	0	-35	-16	-38	-10	-45	-30	-52	-24	-59	-44	-66	-32	-72	50	65
65	80	0	-40	-18	-45	-12	-52	-36	-61	-28	-68	-56	-81	-41	-88	65	80
80	100	0	-46	-22	-51	-14	-60	-41	-70	-33	-79	-71	-100	-63	-109	80	100
100	120	0	-52	-25	-57	-14	-66	-47	-79	-36	-88	-85	-117	-74	-126	100	120
120	140	0	-57	-26	-62	-16	-73	-51	-87	-41	-98	-97	-133	-87	-144	120	140
140	160	0	-63	-27	-67	-17	-80	-55	-95	-45	-108	-113	-153	-103	-166	140	160
160	180	-26	-96	-44	-88	-44	-114	-78	-122	-78	-148	-155	-199	-155	-225	160	180
180	200	-30	-110	-50	-100	-50	-130	-88	-138	-88	-168	-175	-225	-175	-225	180	200
200	225	-34	-124	-56	-112	-56	-146	-100	-156	-100	-190	-185	-235	-185	-265	200	225
225	250	-40	-145	-66	-132	-66	-171	-120	-186	-120	-225	-220	-276	-220	-310	225	250

Appendix table-9: Basic tolerance

Unit: μm

Basic dimension mm		IT basic tolerance class									
Over	Incl.	IT1	IT2	IT3	IT4	IT5	IT6	IT7	IT8	IT9	IT10
—	3	0.8	1.2	2	3	4	6	10	14	25	40
3	6	1	1.5	2.5	4	5	8	12	18	30	48
6	10	1	1.5	2.5	4	6	9	15	22	36	58
10	18	1.2	2	3	5	8	11	18	27	43	70
18	30	1.5	2.5	4	6	9	13	21	33	52	84
30	50	1.5	2.5	4	7	11	16	25	39	62	100
50	80	2	3	5	8	13	19	30	46	74	120
80	120	2.5	4	6	10	15	22	35	54	87	140
120	180	3.5	5	8	12	18	25	40	63	100	160
180	250	4.5	7	10	14	20	29	46	72	115	185
250	315	6	8	12	16	23	32	52	81	130	210
315	400	7	9	13	18	25	36	57	89	140	230
400	500	8	10	15	20	27	40	63	97	155	250
500	630	9	11	16	22	30	44	70	110	175	280
630	800	10	13	18	25	35	50	80	125	200	320
800	1 000	11	15	21	29	40	56	90	140	230	360
1 000	1 250	13	18	24	34	46	66	105	165	260	420
1 250	1 600	15	21	29	40	54	78	125	195	310	500
1 600	2 000	18	25	35	48	65	92	150	230	370	600
2 000	2 500	22	30	41	57	77	110	175	280	440	700
2 500	3 150	26	36	50	69	93	135	210	330	540	860

Appendix table-10: Viscosity conversion table

Dynamic viscosity mm^2/s	Saybolt SUS (second)	Redwood R" (second)	Engler E (degree)	Dynamic viscosity mm^2/s	Saybolt SUS (second)	Redwood R" (second)	Engler E (degree)
2.7	35	32.2	1.18	103	475	419	13.5
4.3	40	36.2	1.32	108	500	441	14.2
5.9	45	40.6	1.46	119	550	485	15.6
7.4	50	44.9	1.60	130	600	529	17.0
8.9	55	49.1	1.75	141	650	573	18.5
10.4	60	53.5	1.88	152	700	617	19.9
11.8	65	57.9	2.02	163	750	661	21.3
13.1	70	62.3	2.15	173	800	705	22.7
14.5	75	67.6	2.31	184	850	749	24.2
15.8	80	71.0	2.42	195	900	793	25.6
17.0	85	75.1	2.55	206	950	837	27.0
18.2	90	79.6	2.68	217	1 000	882	28.4
19.4	95	84.2	2.81	260	1 200	1 058	34.1
20.6	100	88.4	2.95	302	1 400	1 234	39.8
23.0	110	97.1	3.21	347	1 600	1 411	45.5
25.0	120	105.9	3.49	390	1 800	1 587	51
27.5	130	114.8	3.77	433	2 000	1 763	57
29.8	140	123.6	4.04	542	2 500	2 204	71
32.1	150	132.4	4.32	650	3 000	2 646	85
34.3	160	141.1	4.59	758	3 500	3 087	99
36.5	170	150.0	4.88	867	4 000	3 526	114
38.8	180	158.8	5.15	974	4 500	3 967	128
41.0	190	167.5	5.44	1082	5 000	4 408	142
43.2	200	176.4	5.72	1150	5 500	4 849	156
47.5	220	194.0	6.28	1300	6 000	5 290	170
51.9	240	212	6.85	1400	6 500	5 730	185
56.5	260	229	7.38	1510	7 000	6 171	199
60.5	280	247	7.95	1630	7 500	6 612	213
64.9	300	265	8.51	1740	8 000	7 053	227
70.3	325	287	9.24	1850	8 500	7 494	242
75.8	350	309	9.95	1960	9 000	7 934	256
81.2	375	331	10.7	2070	9 500	8 375	270
86.8	400	353	11.4	2200	10 000	8 816	284
92.0	425	375	12.1				
97.4	450	397	12.8				

Appendix table-11: Kgf to N conversion table

kgf		N	kgf		N	kgf		N
0.1020	1	9.8066	3.4670	34	333.43	6.8321	67	657.04
0.2039	2	19.613	3.5690	35	343.23	6.9341	68	666.85
0.3059	3	29.420	3.6710	36	353.04	7.0361	69	676.66
0.4079	4	39.227	3.7730	37	362.85	7.1380	70	686.46
0.5099	5	49.033	3.8749	38	372.65	7.2400	71	696.27
0.6118	6	58.840	3.9769	39	382.46	7.3420	72	706.08
0.7138	7	68.646	4.0789	40	392.27	7.4440	73	715.88
0.8158	8	78.453	4.1808	41	402.07	7.5459	74	725.69
0.9177	9	88.260	4.2828	42	411.88	7.6479	75	735.50
1.0197	10	98.066	4.3848	43	421.68	7.7499	76	745.30
1.1217	11	107.87	4.4868	44	431.49	7.8518	77	755.11
1.2237	12	117.68	4.5887	45	441.30	7.9538	78	764.92
1.3256	13	127.49	4.6907	46	451.10	8.0558	79	774.72
1.4276	14	137.29	4.7927	47	460.91	8.1578	80	784.53
1.5296	15	147.10	4.8946	48	470.72	8.2597	81	794.34
1.6316	16	156.91	4.9966	49	480.52	8.3617	82	804.14
1.7335	17	166.71	5.0986	50	490.33	8.4637	83	813.95
1.8355	18	176.52	5.2006	51	500.14	8.5656	84	823.76
1.9375	19	186.33	5.3025	52	509.94	8.6676	85	833.56
2.0394	20	196.13	5.4045	53	519.75	8.7696	86	843.37
2.1414	21	205.94	5.5065	54	529.56	8.8716	87	853.18
2.2434	22	215.75	5.6085	55	539.36	8.9735	88	862.98
2.3454	23	225.55	5.7104	56	549.17	9.0755	89	872.79
2.4473	24	235.36	5.8124	57	558.98	9.1775	90	882.60
2.5493	25	245.17	5.9144	58	568.78	9.2794	91	892.40
2.6513	26	254.97	6.0163	59	578.59	9.3814	92	902.21
2.7532	27	264.78	6.1183	60	588.40	9.4834	93	912.02
2.8552	28	274.59	6.2203	61	598.20	9.5854	94	921.82
2.9572	29	284.39	6.3223	62	608.01	9.6873	95	931.63
3.0592	30	294.20	6.4242	63	617.82	9.7893	96	941.44
3.1611	31	304.01	6.5262	64	627.62	9.8913	97	951.24
3.2631	32	313.81	6.6282	65	637.43	9.9932	98	961.05
3.3651	33	323.62	6.7302	66	647.24	10.0952	99	970.86

[How to read the table] If for example you want to convert 10 kgf to N, find "10" in the middle column of the first set of columns. Look in the N column directly to the right of "10," and you will see that 10 kgf equals 98.066 N. Oppositely, to convert 10 N to kgf, look in the kgf column to the left of "10" and you will see that 10 N equals 1.0197 kgf.

1kgf=9.80665N
1N=0.101972kgf

Appendix table-12: Inch / millimeter conversion table

Inch		0"	1"	2"	3"	4"	5"	6"	7"	8"	9"
Fraction	Decimal										
1/64	0.015625	0.397	25.400	50.800	76.200	101.600	127.000	152.400	177.800	203.200	228.600
1/32	0.031250	0.794	25.797	51.197	76.597	101.997	127.397	152.797	178.197	203.597	228.997
3/64	0.046875	1.191	26.194	51.594	76.994	102.394	127.794	153.194	178.594	203.994	229.394
1/16	0.062500	1.588	26.591	51.991	77.391	102.791	128.191	153.591	178.991	204.391	229.791
5/64	0.078125	1.984	26.988	52.388	77.788	103.188	128.588	153.988	179.388	204.788	230.188
3/32	0.093750	2.381	27.384	52.784	78.184	103.584	128.984	154.384	179.784	205.184	230.584
7/64	0.109375	2.778	27.781	53.181	78.581	103.981	129.381	154.781	180.181	205.581	230.981
1/8	0.125000	3.175	28.178	53.578	78.978	104.378	129.778	155.178	180.578	205.978	231.378
9/64	0.140625	3.572	28.575	53.975	79.375	104.775	130.175	155.575	180.975	206.375	231.775
5/32	0.156250	3.969	28.972	54.372	79.772	105.172	130.572	155.972	181.372	206.772	232.172
11/64	0.171875	4.366	29.369	54.769	80.169	105.569	130.969	156.369	181.769	207.169	232.569
3/16	0.187500	4.762	29.766	55.166	80.566	105.966	131.366	156.766	182.166	207.566	232.966
13/64	0.203125	5.159	30.162	55.562	80.962	106.362	131.762	157.162	182.562	207.962	233.362
7/32	0.218750	5.556	30.559	55.959	81.359	106.759	132.159	157.559	182.959	208.359	233.759
15/64	0.234375	5.953	30.956	56.356	81.756	107.156	132.556	157.956	183.356	208.756	234.156
1/4	0.250000	6.350	31.353	56.753	82.153	107.553	132.953	158.353	183.753	209.153	234.553
17/64	0.265625	6.747	31.750	57.150	82.550	107.950	133.350	158.750	184.150	209.550	234.950
9/32	0.281250	7.144	32.147	57.547	82.947	108.347	133.747	159.147	184.547	209.947	235.347
19/64	0.296875	7.541	32.544	57.944	83.344	108.744	134.144	159.544	184.944	210.344	235.744
5/16	0.312500	7.938	32.941	58.341	83.741	109.141	134.541	159.941	185.341	210.741	236.141
21/64	0.328125	8.334	33.338	58.738	84.138	109.538	134.938	160.338	185.738	211.138	236.538
11/32	0.343750	8.731	33.734	59.134	84.534	109.934	135.334	160.734	186.134	211.534	236.934
23/64	0.359375	9.128	34.131	59.531	84.931	110.331	135.731	161.131	186.531	211.931	237.331
3/8	0.375000	9.525	34.528	59.928	85.328	110.728	136.128	161.528	186.928	212.328	237.728
25/64	0.390625	9.922	34.925	60.325	85.725	111.125	136.525	161.925	187.325	212.725	238.125
13/32	0.406250	10.319	35.322	60.722	86.122	111.522	136.922	162.322	187.722	213.122	238.522
27/64	0.421875	10.716	35.719	61.119	86.519	111.919	137.319	162.719	188.119	213.519	238.919
7/16	0.437500	11.112	36.116	61.516	86.916	112.316	137.716	163.116	188.516	213.916	239.316
29/64	0.453125	11.509	36.512	61.912	87.312	112.712	138.112	163.512	188.912	214.312	239.712
15/32	0.468750	11.906	36.909	62.309	87.709	113.109	138.509	163.909	189.309	214.709	240.109
31/64	0.484375	12.303	37.306	62.706	88.106	113.506	138.906	164.306	189.706	215.106	240.506
1/2	0.500000	12.700	37.703	63.103	88.503	113.903	139.303	164.703	190.103	215.503	240.903
33/64	0.515625	13.097	38.100	63.500	88.900	114.300	139.700	165.100	190.500	215.900	241.300
17/32	0.531250	13.494	38.497	63.897	89.297	114.697	140.097	165.497	190.897	216.297	241.697
35/64	0.546875	13.891	38.894	64.294	89.694	115.094	140.494	165.894	191.294	216.694	242.094
9/16	0.562500	14.288	39.291	64.691	90.091	115.491	140.891	166.291	191.691	217.091	242.491
37/64	0.578125	14.684	39.688	65.088	90.488	115.888	141.288	166.688	192.088	217.488	242.888
19/32	0.593750	15.081	40.084	65.484	90.884	116.284	141.684	167.084	192.484	217.884	243.284
39/64	0.609375	15.478	40.481	65.881	91.281	116.681	142.081	167.481	192.881	218.281	243.681
5/8	0.625000	15.875	40.878	66.278	91.678	117.078	142.478	167.878	193.278	218.678	244.078
41/64	0.640625	16.272	41.275	66.675	92.075	117.475	142.875	168.275	193.675	219.075	244.475
21/32	0.656250	16.669	41.672	67.072	92.472	117.872	143.272	168.672	194.072	219.472	244.872
43/64	0.671875	17.066	42.069	67.469	92.869	118.269	143.669	169.069	194.469	219.869	245.269
11/16	0.687500	17.462	42.466	67.866	93.266	118.666	144.066	169.466	194.866	220.266	245.666
45/64	0.703125	17.859	42.862	68.262	93.662	119.062	144.462	169.862	195.262	220.662	246.062
23/32	0.718750	18.256	43.259	68.659	94.059	119.459	144.859	170.259	195.659	221.056	246.459
47/64	0.734375	18.653	43.656	69.056	94.456	119.856	145.256	170.656	196.056	221.456	246.856
3/4	0.750000	19.050	44.053	69.453	94.853	120.253	145.653	171.053	196.453	221.853	247.253
49/64	0.765625	19.447	44.450	69.850	95.250	120.650	146.050	171.450	196.850	222.250	247.650
25/32	0.781250	19.844	44.847	70.247	95.647	121.047	146.447	171.847	197.247	222.647	248.047
51/64	0.796875	20.241	45.244	70.644	96.044	121.444	146.844	172.244	197.644	223.044	248.444
13/16	0.812500	20.638	45.641	71.041	96.441	121.841	147.241	172.641	198.041	223.441	248.841
53/64	0.828125	21.034	46.038	71.438	96.838	122.238	147.638	173.038	198.438	223.838	249.238
27/32	0.843750	21.431	46.434	71.834	97.234	122.634	148.034	173.434	198.834	224.234	249.634
55/64	0.859375	21.828	46.831	72.231	97.631	123.031	148.431	173.831	199.231	224.631	250.031
7/8	0.875000	22.225	47.228	72.628	98.028	123.428	148.828	174.228	199.628	225.028	250.428
57/64	0.890625	22.622	47.625	73.025	98.425	123.825	149.225	174.625	200.025	225.425	250.825
29/32	0.906250	23.019	4								

Appendix table-13: Hardness conversion table (reference)-1

Rockwell hardness	Vickers hardness	Brinell hardness		Rockwell hardness		Shore hardness
		Standard steel balls	Tungsten carbide steel balls	A scale 588.4N	B scale 980.7N	
C scale 1471.0N						
68	940			85.6		97
67	900			85.0		95
66	865			84.5		92
65	832		739	83.9		91
64	800		722	83.4		88
63	772		705	82.8		87
62	746		688	82.3		85
61	720		670	81.8		83
60	697		654	81.2		81
59	674		634	80.7		80
58	653		615	80.1		78
57	633		595	79.6		76
56	613		577	79.0		75
55	595	—	560	78.5		74
54	577	—	543	78.0		72
53	560	—	525	77.4		71
52	544	500	512	76.8		69
51	528	487	496	76.3		68
50	513	475	481	75.9		67
49	498	464	469	75.2		66
48	484	451	455	74.7		64
47	471	442	443	74.1		63
46	458	432	432	73.6		62
45	446	421	421	73.1		60
44	434	409	409	72.5		58
43	423	400	400	72.0		57
42	412	390	390	71.5		56
41	402	381	381	70.9		55
40	392	371	371	70.4	—	54
39	382	362	362	69.9	—	52
38	372	353	353	69.4	—	51
37	363	344	344	68.9	—	50
36	354	336	336	68.4	(109.0)	49
35	345	327	327	67.9	(108.5)	48
34	336	319	319	67.4	(108.0)	47
33	327	311	311	66.8	(107.5)	46
32	318	301	301	66.3	(107.0)	44
31	310	294	294	65.8	(106.0)	43
30	302	286	286	65.3	(105.5)	42
29	294	279	279	64.7	(104.5)	41
28	286	271	271	64.3	(104.0)	41
27	279	264	264	63.8	(103.0)	40
26	272	258	258	63.3	(102.5)	38
25	266	253	253	62.8	(101.5)	38
24	260	247	247	62.4	(101.0)	37
23	254	243	243	62.0	100.0	36
22	248	237	237	61.5	99.0	35
21	243	231	231	61.0	98.5	35

1) Quoted from hardness conversion table (SAE J 417)

Appendix table-13: Hardness conversion table (reference)-2

Rockwell hardness	Vickers hardness	Brinell hardness		Rockwell hardness		Shore hardness
		Standard steel balls	Tungsten carbide steel balls	A scale 588.4N	B scale 980.7N	
C scale 1471.0N						
20	238	226	226	60.5	97.8	34
(18)	230	219	219	—	96.7	33
(16)	222	212	212	—	95.5	32
(14)	213	203	203	—	93.9	31
(12)	204	194	194	—	92.3	29
(10)	196	187	187		90.7	28
(8)	188	179	179		89.5	27
(6)	180	171	171		87.1	26
(4)	173	165	165		85.5	25
(2)	166	158	158		83.5	24
(0)	160	152	152		81.7	24

1) Quoted from hardness conversion table (SAE J 417)

Appendix table-14: Kg to lb conversion table

kg		lb	kg		lb	kg		lb
0.454	1	2.205	15.422	34	74.957	30.391	67	147.71
0.907	2	4.409	15.876	35	77.162	30.844	68	149.91
1.361	3	6.614	16.329	36	79.366	31.298	69	152.12
1.814	4	8.818	16.783	37	81.571	31.751	70	154.32
2.268	5	11.023	17.237	38	83.776	32.205	71	156.53
2.722	6	13.228	17.690	39	85.980	32.659	72	158.73
3.175	7	15.432	18.144	40	88.185	33.112	73	160.94
3.629	8	17.637	18.597	41	90.390	33.566	74	163.14
4.082	9	19.842	19.051	42	92.594	34.019	75	165.35
4.536	10	22.046	19.504	43	94.799	34.473	76	167.55
4.990	11	24.251	19.958	44	97.003	34.927	77	169.76
5.443	12	26.455	20.412	45	99.208	35.380	78	171.96
5.897	13	28.660	20.865	46	101.41	35.834	79	174.17
6.350	14	30.865	21.319	47	103.62	36.257	80	176.37
6.804	15	33.069	21.772	48	105.82	36.741	81	178.57
7.257	16	35.274	22.226	49	108.03	37.195	82	180.78
7.711	17	37.479	22.680	50	110.23	37.648	83	182.98
8.165	18	39.683	23.133	51	112.44	38.102	84	185.19
8.618	19	41.888	23.587	52	114.64	38.555	85	187.39
9.072	20	44.092	24.040	53	116.84	39.009	86	189.60
9.525	21	46.297	24.494	54	119.05	39.463	87	191.80
9.979	22	48.502	24.948	55	121.25	39.916	88	194.01
10.433	23	50.706	25.401	56	123.46	40.370	89	196.21
10.886	24	62.911	26.855	57	125.66	40.823	90	198.42
11.340	25	55.116	26.308	58	127.87	41.277	91	200.62
11.793	26	57.320	26.762	59	130.07	41.730	92	202.83
12.247	27	59.525	27.216	60	132.28	42.184	93	205.03
12.701	28	61.729	27.669	61	134.48	42.638	94	207.23
13.154	29	63.934	28.123	62	136.69	43.091	95	209.44
13.608	30	66.139	28.576	63	138.69	43.546	96	211.64
14.061	31	68.343	29.030	64	141.10	43.996	97	213.85
14.515	32	70.548	29.484	65	143.30	44.452	98	216.05
14.969	33	72.753	29.937	66	145.51	44.906	99	218.26

[How to read the table] If for example you want to convert 10 kg to lb, find "10" in the middle column of the first set of columns. Look in the lb column directly to the right of "10," and you will see that 10 kg equals 22.046 lb. Oppositely, to convert 10 lb to kg, look in the kg column to the left of "10" and you will see that 10 lb equals 4.536 kg.

1kg = 2.2046226 lb
1lb = 0.45359237 kg

Appendix table 15: °C to °F conversion table

°C		°F	°C		°F	°C		°F	°C		°F
-73.3	-100	-148.0	0.0	32	89.6	21.7	71	159.8	43.3	110	230
-62.2	-80	-112.0	0.6	33	91.4	22.2	72	161.6	46.1	115	239
-51.1	-60	-76.0	1.1	34	93.2	22.8	73	163.4	48.9	120	248
-40.0	-40	-40.0	1.7	35	95.0	23.3	74	165.2	51.7	125	257
-34.4	-30	-22.0	2.2	36	96.8	23.9	75	167.0	54.4	130	266
-28.9	-20	-4.0	2.8	37	98.6	24.4	76	168.8	57.2	135	275
-23.3	-10	14.0	3.3	38	100.4	25.0	77	170.6	60.0	140	284
-17.8	0	32.0	3.9	39	102.2	25.6	78	172.4	65.6	150	302
-17.2	1	33.8	4.4	40	104.0	26.1	79	174.2	71.1	160	320
-16.7	2	35.6	5.0	41	105.8	26.7	80	176.0	76.7	170	338
-16.1	3	37.4	5.6	42	107.6	27.2	81	177.8	82.2	180	356
-15.6	4	39.2	6.1	43	109.4	27.8	82	179.6	87.8	190	374
-15.0	5	41.0	6.7	44	111.2	28.3	83	181.4	93.3	200	392
-14.4	6	42.8	7.2	45	113.0	28.9	84	183.2	98.9	210	410
-13.9	7	44.6	7.8	46	114.8	29.4	85	185.0	104.4	220	428
-13.3	8	46.4	8.3	47	116.6	30.0	86	186.8	110.0	230	446
-12.8	9	48.2	8.9	48	118.4	30.6	87	188.6	115.6	240	464
-12.2	10	50.0	9.4	49	120.2	31.1	88	190.4	121.1	250	482
-11.7	11	51.0	10.0	50	122.0	31.7	89	192.2	148.9	300	572
-11.1	12	53.6	10.6	51	123.8	32.2	90	194.0	176.7	350	662
-10.6	13	55.4	11.1	52	125.6	32.8	91	195.8	204	400	752
-10.0	14	57.2	11.7	53	127.4	33.3	92	197.6	232	450	842
-9.4	15	59.0	12.2	54	129.2	33.9	93	199.4	260	500	932
-8.9	16	60.8	12.6	55	131.0	34.4	94	201.2	288	550	1022
-8.3	17	62.6	13.3	56	132.8	35.0	95	203.0	316	600	1112
-7.8	18	64.4	13.9	57	134.6	35.6	96	204.6	343	650	1202
-7.2	19	66.2	14.4	58	136.4	36.1	97	206.6	371	700	1292
-6.7	20	68.0	15.0	59	138.2	36.7	98	208.4	399	750	1382
-6.1	21	69.8	15.6	60	140.0	37.2	99	210.2	427	800	1472
-5.6	22	71.5	15.1	61	141.8	37.8	100	212.0	454	850	1562
-5.0	23	73.4	16.7	62	143.6	38.3	101	213.8	482	900	1652
-4.4	24	76.2	17.2	63	145.4	38.9	102	215.6	510	950	1742
-3.9	25	77.0	17.8	64	147.2	39.4	103	217.4	538	1000	1832
-3.3	26	78.8	18.3	65	149.0	40.0	104	219.2	593	1100	2012
-2.8	27	80.5	18.9	66	150.8	40.6	105	221.0	649	1200	2192
-2.2	28	82.4	19.4	67	152.6	41.1	106	222.6	704	1300	2372
-1.7	29	84.2	20.0	68	154.4	41.7	107	224.6	760	1400	2562
-1.1	30	86.0	20.6	69	156.2	42.2	108	226.4	816	1500	2732
-0.6	31	87.8	21.1	70	158.0	42.8	109	228.2	871	1600	2912

[How to read the table] If for example you want to convert 10°C to °F, find "10" in the middle column of the first set of columns. Look in the °F column directly to the right of "10," and you will see that 10°C equals 50.0 °F. Oppositely, to convert 10°F to °C, look in the °C column to the left of "10" and you will see that 10°F equals -12.2°C.

[Conversion formula]
°C = $\frac{5}{9}(\text{°F}-32)$
°F = $32 + \frac{9}{5}\text{°C}$

HEADQUARTERS

NTN Corporation URL <https://www.ntn.co.jp>

1-3-17, Kyomachibori, Nishi-ku, Osaka-shi, Osaka 550-0003 Japan Phone: +81-6-6443-5001

NTN USA Corporation URL <https://www.ntnamericas.com>

1600 E. Bishop Court, P.O. Box 7604, Mount Prospect, IL 60056-7604, U.S.A. Phone: +1-847-298-7500 Fax: +1-847-294-1209

SALES NETWORK

NTN Bearing Corp. of America

Head Office / 1600 E. Bishop Court, P.O. Box 7604, Mount Prospect, IL 60056-7604, U.S.A.

Phone: +1-847-298-7500 Fax: +1-847-699-9744

Peoria Sales Office / 2413 North Main Street, East Peoria, Illinois 61611, U.S.A.

Phone: +1-309-699-8600 Fax: +1-309-699-8670

NTN Automotive Center / 39255 W. 12 Mile Road, Farmington Hills, MI 48331-2975, U.S.A.

Phone: +1-248-324-4700 Fax: +1-248-324-1103

NTN Bearing Corp. of Canada Ltd. URL <http://www.ntnamericas.com>

Head Office / 305 Courtneypark Drive West, Mississauga, Ontario, L5W 1Y4, Canada

Phone: +1-905-564-2700 Fax: +1-905-564-9023

Edmonton Branch / 4608-97th Street, Edmonton, Alberta T6E 5N9, Canada

Phone: +1-780-435-6200 Fax: +1-780-435-3600

Toronto Branch / 305 Courtneypark Drive West, Mississauga, Ontario L5W 1Y4, Canada

Phone: +1-905-564-2700 Fax: +1-905-564-9609

Montreal Branch / 4973 Levy Street, St-Laurent, Quebec, H4R 2N9, Canada

Phone: +1-514-333-8054 Fax: +1-514-333-1078

NTN Wälzlager (Europa) GmbH. URL <http://www.ntn-snr.com>

Head Office / Max-Planck-Str. 23, 40699 Erkrath, F.R.Germany

Phone: +49-211-2508-0 Fax: +49-211-2508-400

Stuttgart Branch / Plieninger Str. 63B, 70794 Filderstadt F.R.Germany

Phone: +49-711-123901-0 Fax: +49-711-123901-660

NTN Bearings (UK) Ltd. URL <http://www.ntn-snr.com>

Wellington Crescent, Fradley Park, Lichfield, Staffordshire, WS13 8RZ, UK

Phone: +44-1543-445000 Fax: +44-1543-445035

NTN-SNR ROULEMENTS. URL <http://www.ntn-snr.com>

Head Office / 1, rue des Usines B.P. 2017 74010 Annecy Cedex, France

Phone: +33-4-50-65-30-00 Fax: +33-4-50-65-30-88

Lyon Branch / 51, rue des Docks, 69009 Lyon, France

Phone: +33-4-78-66-68-00 Fax: +33-4-78-66-68-20

Paris Branch / 6, rue Auguste Comte, BP49, 92174 Vanves Cedex, France

Phone: +33-1-40-93-66-00 Fax: +33-1-40-93-66-10

Cran Gevrier Branch / 6 route de la Salle, 74960, Cran Gevrier, France

Phone: +33-4-50-65-93-00 Fax: +33-4-50-65-93-46

Argonay Branch / 114, Rte de Champ Farçon, 74370, Argonay, France

Phone: +33-4-50-65-94-00 Fax: +33-4-50-65-94-25

SNR Wälzlager GmbH.

Head Office / Max-Planck-Str. 23, 40699 Erkrath, F.R.Germany

Phone: +49-211-2508-0 Fax: +49-211-2508-400

Bielefeld Branch / Friedrich-Hagemann-Straße 66, 33719 Bielefeld, F.R.Germany

Phone: +49-521-9-24-00-0 Fax: +49-521-9-24-00-90

Stuttgart Branch / Plieninger Str. 63B, 70794 Filderstadt F.R.Germany

Phone: +49-711-123901-0 Fax: +49-711-123901-660

NTN-SNR ITALIA S.P.A.

Head Office / Via Riccardo Lombardi, 19/4, 20153 Milan, Italy

Phone: +39-02-47-99-86-1 Fax: +39-02-33-50-06-56

Bologna Office / Via Maestri del Lavoro 3/A 40138 Bologna, Italy

Phone: +39-051-47-53-51-74 Fax: +39-051-47-53-84-92

NTN-SNR IBERICA SA / Edificio A - Planta Baja Derecha, C / Basauri, 17, 28023 - Madrid, Spain

Phone: +34-916-71-89-13 Fax: +34-916-73-65-48

NTN-SNR RULMENTI S.R.L. / Zona Industriale-Vest, 6 Strada Salzburg, 24 00 SIBIU, Romania

Phone: +40-269-20-35-00 Fax: +40-269-20-35-25

NTN-SNR Morocco / Route cotiere 111, Quartier industriel, Polygone 1, Casablanca, Morocco

Phone: +212-522-66-76-80 Fax: +212-522-66-5166

NTN Bearing-Singapore (Pte) Ltd. URL <https://www.ntnsg.com>

No.9 Clementi Loop Singapore 129812

Phone: + 65-64698066 Fax: +65-64695400

NTN Bearing-Vietnam Co., Ltd.

17th Floor, Viettower Building, No.1 Thai Ha street, Truong Liet Ward, Dong Da District, Hanoi, Vietnam

Phone: +84-4-37347660 Fax: +84-4-37347662

NTN Bearing India PVT. Ltd. URL <http://ntnbearing.in>

Head Office / No. 86, 2nd Floor, Polyhose Towers Mount Road Guindy Chennai 600032, India

Phone: +91-44-66867700 Fax: +91-44-66867701

Delhi Branch / 819, 8th Floor, International Trade Tower, Nehru Place, New Delhi - 1100019, India

Phone: +91-11-40520407 Fax: +91-11-40520407

Mumbai Branch / Unit No :1104, DLH PARK, S V Road, Goregaon West, Mumbai - 400062, India

Phone: +91-22-28768501 Fax: +91-22-28768900

Kolkata Branch / 8th Floor, "C" Landmark Building, AJC Bose Road, Kolkata - 700020, India

Phone: +91-33-46031129

NTN (China) Investment Corp. URL <https://www.ntn.com.cn>

Shanghai Head Office / No.6 building No.1666 Nanle Road, Songjiang Industrial Zone, Songjiang, Shanghai 201611, China

Phone: +86-21-5774-5500 Fax: +86-21-5778-2898

Beijing Branch / Unit 2808, Fortune Financial Center, No.5 Dongsanhuan Zhong Road, Chaoyang District, Beijing 100020, China

Phone: +86-10-6568-3069 Fax: +86-10-6568-2278

Guangzhou Branch / Room 3606, Onelink Center, No.230-232 Tianhe Road, Tianhe District, Guangzhou 510620, China

Phone: +86-20-3877-2943 Fax: +86-20-3877-2942

Nanjing Branch / D1D2, Nanjing Centre, NO.1 Zhongshan South Rd, Qinhui District, Nanjing 210005, China

Phone: +86-25-8477-5355 Fax: +86-25-8477-5360

Chongqing Branch / Room 15-6, Carnival mansion, No.9 Guanyingqiao Street, Jiangbei District, Chongqing 400020, China

Phone: +86-23-6796-0812 Fax: +86-23-6796-0878

Shenyang Branch / Room 2606, China Resources Building, No.286 Qingnian Road, Heping District, Shenyang 110004, China

Phone: +86-24-3137-9186 Fax: +86-24-3137-9185

NTN China Ltd. URL <http://www.ntnchina.com>

Hong Kong Office / Room 2003-05, Gala Place, No.56 Dundas Road, Mongkok, Kowloon, Hong Kong

Phone: +852-2385-5097 Fax: +852-2385-2138

NTN Bearing-Thailand Co., Ltd. URL <http://www.ntn.co.th>

Head Office / 29th Floor Panjathani Tower, 127/34 Nonsee Road, Chongnonsee, Yannawa, BANGKOK 10120, Thailand

Phone: +66-2-681-0401 Fax: +66-2-681-0409

Khon Kaen Branch / 189/191 Ruenrom Road, Mueang, Khon Kaen 400003.

Phone: +66-43-222237 Fax: +66-43-223061

Haad Yai Branch / 156/101-102 Moo 1, Lopburi Ramesuan Road, Klong Hae, Had Yai, Songkhla 90110

Phone: +66-74-292651 Fax: +66-74-292656

Chiangmai Branch / 208 Moo 4, Wong wan rob klang, Nong Hoi, Amphur Muang, Chiang Mai 50000

Phone: +66-53-142571 Fax: +66-53-142573

NTN Bearing-Malaysia Sdn. Bhd.

Head Office / No.2, Jalan Arkitek U 1/22, Hicom Glenmarie Industrial Park, 40150 Shah Alam, Selangor Darul Ehsan, Malaysia

Phone: +60-3-55696088 Fax: +60-3-55690200

Butterworth Branch / 5063, Jalan Sungai Nyior Indah, Taman Sungai Nyior Indah, 12100 Butterworth, Penang, Malaysia

Phone: +60-4-3328312 Fax: +60-4-3324407

Ipoh Branch Office / 65, Medan Kidd, Kinta Mansion, 30200 Ipoh, Malaysia

Phone: +60-5-2547743 Fax: +60-5-2538077

Kuantan Branch / B-72, Ground Floor, Jalan Beserah 25300 Kuantan, Malaysia

Phone: +60-9-5141132 Fax: +60-9-5141164

Johor Bahru Branch / 51 Jalan, Sri Bahagia 5, Taman Sri Bahagia, Tampoi, 81200 Johor Bahru, Malaysia

Phone: +60-7-2364929 Fax: +60-7-2370897

PT. NTN Bearing Indonesia

MidPlaza 1, 7th Floor, Jl. Jend. Sudirman Kav. 10 -11 Jakarta, Indonesia 10220

Phone : + 62-21-5707676 Fax : 62-21-5707699

NTN-CBC (Australia) Pty. Ltd. URL <https://www.conbear.com.au>

18 Worth Street Chullora NSW 2190, Sydney Australia

Phone: +61-2-9947 9200 Fax: +61-2-9502 4013

NTN de Mexico, S.A. URL <http://www.ntnamericas.com/es>

Head Office / Emilio Cárdenas No.158 Apdo.124, C.P.54030, Tlalnepantla, Edo.deMéxico, Mexico

Phone: +52-55-5390-1133 Fax: +52-55-5565-8545

Guadalajara Branch / Calle 22 No.2465, Zona Industrial, C.P.44940, Guadalajara, Jalisco, Mexico

Phone: +52-33-3145-1448 Fax: +52-33-3145-1594

Monterrey Branch / Av. America del Norte 209, Fracc. Industrial Las Americas, C.P.67120, Guadalupe, Nuevo Leon

Phone: +52-818-334-9932 Fax: +52-818-334-9932

NTN Sudamericana, S.A. URL <http://www.ntnamericas.com>

World Trade Center Panamá, Piso 16. Oficina 1601, Urbanización Marbella, Calle 53 Este, Apartado Postal

0832-0487, Panamá, República de Panamá

Phone: +507-269-4777 Fax: +507-264-5592

NTN Rolamentos do Brasil Ltda. URL <https://www.ntn.com.br>

Av. das Industrias, 380-Parque Industrial-CEP 83.820-332-Fazenda Rio Grande-PR-BRAZIL

Phone: +55-41-3-627-80-00 Fax: +55-52-3-627-80-80

NTN Korea Co., Ltd.

Head Office / 10th Fl., 124, Sejong-Daero, Jung-Gu, Seoul, 04520, Korea

Phone: +82-2-720-3666 Fax: +82-2-720-3669

Busan Branch / Rm.707, 5, Jungang-Daero 775 Beon-Gil, Busanjin-Gu, Busan, 47251, Korea

Phone: +82-51-811-1351 Fax: +82-51-811-1353

NOTE: The appearance and specifications may be changed without prior notice if required to improve performance. Although care has been taken to assure the accuracy of the data compiled in this catalog, NTN does not assume any liability to any company or person for errors or omissions.

NTN®